



Human

ヒューマンアカデミー ジュニア
STEAMスクール



ロボット教室

ロボットのきょうかしよ

プレプライマリーコース 回

1

ぶらんこロボ「ゆらりん」



★だい1かい

2022 ねん

11 がつ

にち

なまえ

ちゅうい しょう

ばあっ パーツや でんきぶひんを あんぜんにつかうために

! ばあっ パーツを くちに いれない

くみたてた ばあっ パーツを とりはずすときは、
ぜったいにはをつかてはいけません。
ばあっ パーツを のみこんでは いけません。

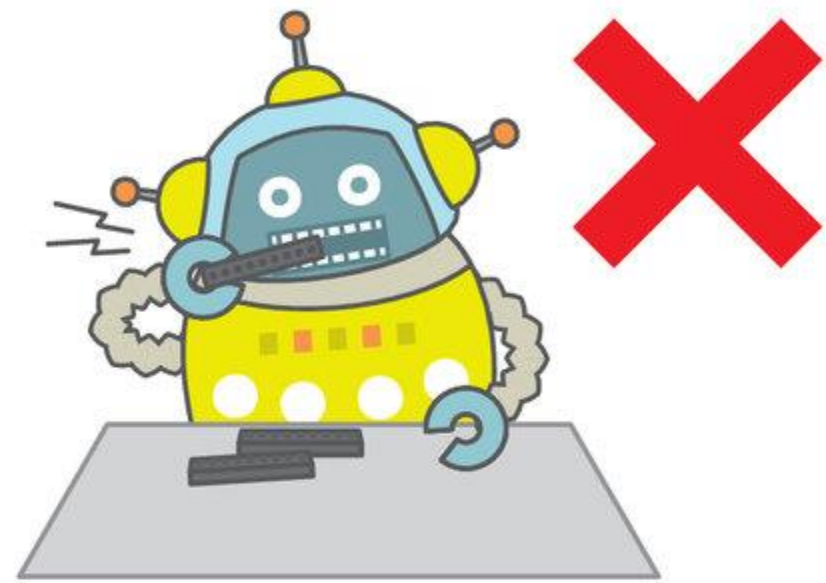

! ぶひんを きずつけない

でんきぶひんを はさみや かつたあ カッターなどで
きずついたり、ばあっ パーツで はさんだりしては
いけません (しゃしん 1)。

こおど や けえぶる コードや ケーブルは、おりまげたり、
ひっぱたりしては いけません。

ぶらぐ の めきさしは、ぶらぐぶぶんを
もって おこないましょう (しゃしん 2)。

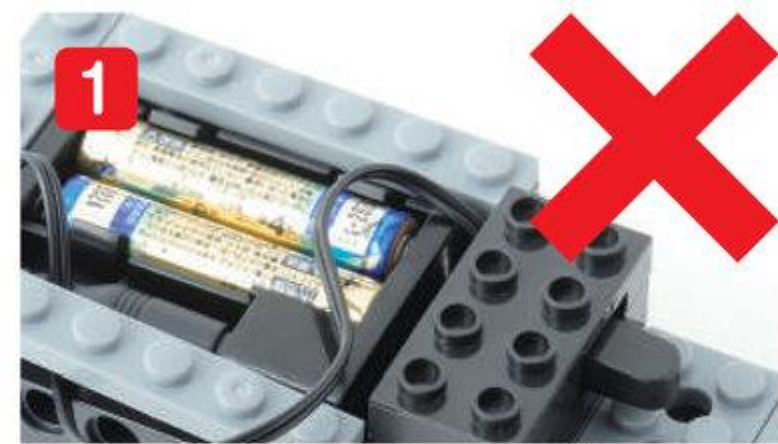

! あつい・におうとき、へんなおとが するとき

ろぼっと ロボットを うごかしたときに、でんちや でんきぶひんが
あつくなったり、へんな においが したり、いつもと ちがうおとが
したばあいは、すぐに ロボットを とめ、せんせいに しらせましょう。
ぬれたてで でんきぶひんを さわってはいけません。

もくじ

だい 1 かい		
ロボット <small>ろぼっと</small> のぶんかい	3	10ぶん
きょうの <small>ばあつ</small> パーツ	4~5	7ぶん
きょうのよてい	6	
くみたて		65ぶん
1. かべ	7~9	
2. じめん	10~20	
3. はしら	21~23	
4. <small>ぶらんこ</small> ブランコ	24~30	
5. もう1つの はしら	31~33	
ロボット <small>ろぼっと</small> を うごかさう	34~35	
クイズ <small>くいず</small>	36	3ぶん
かたづけ		5ぶん

だい 2 かい		
きょうのよてい	38	2ぶん
くみたて		80ぶん
1. <small>ぎあボックス</small> ギアボックス	39~57	
ロボット <small>ろぼっと</small> を うごかさう	58	
くみたて		
2. あたらしい じめん	59~62	
3. あたらしい <small>ぶらんこ</small> ブランコ	63~67	
4. あたらしい はしら	68~70	
ロボット <small>ろぼっと</small> を うごかさう	71	
じゆうに かいぞう してみよう	72	
まちがい さがし	73	3ぶん
かたづけ		5ぶん

ロボットろぼっとのぶんかい めやす 10 ぶん

ぶろっくはずし

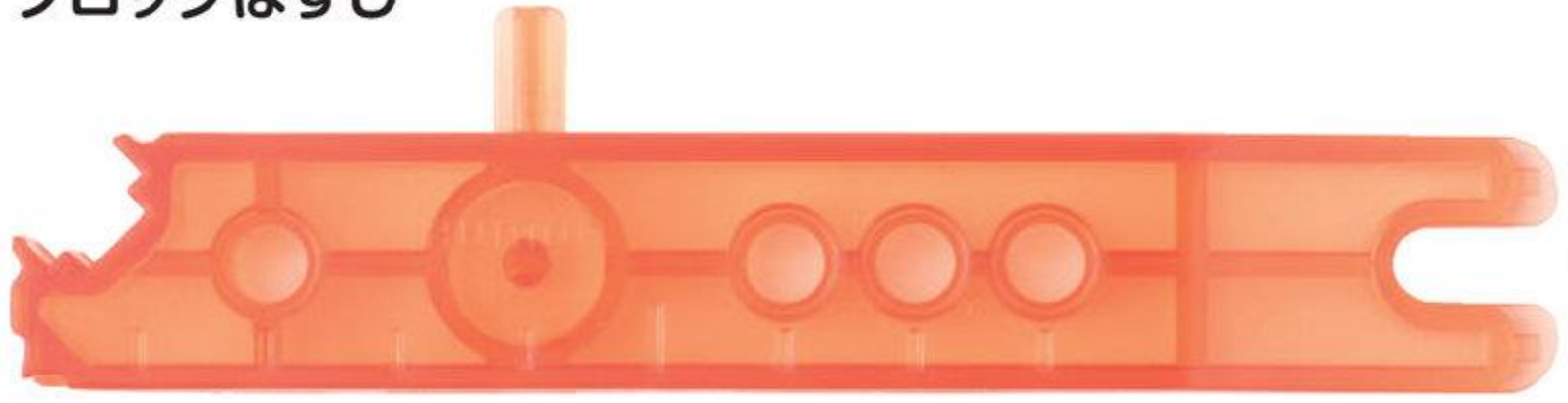

つかうと べんりだよ

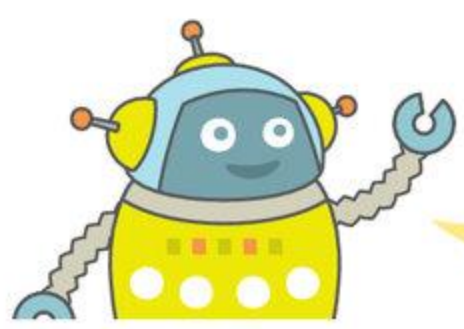

せっと このセットは くずさないでね! またつかうよ



めやす **5** ぶん

ていじょいんと Tジョイント

ばあつ パーツをみつけよう



てい
Tのじに
にているよ



とくちょう

ばあつ
パーツをとりつけられるアナは
いくつあるかな？

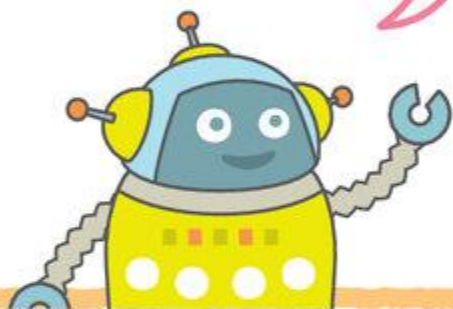

まず あ た あ し あ しょう

あな あ しゃふと
2つあるアナにシャフトをとりつけられるよ

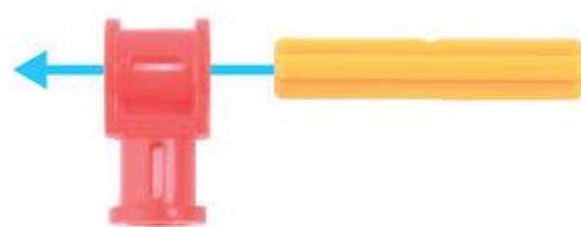

ここで
つかうよ

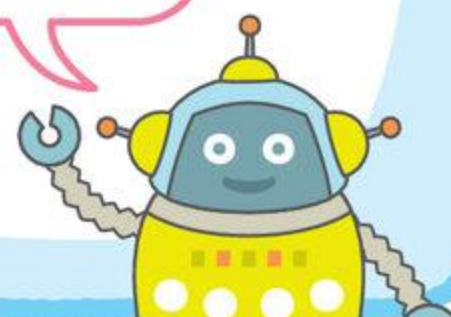

くろすじょいんと クロスジョイント

ぱあつをみつけよう

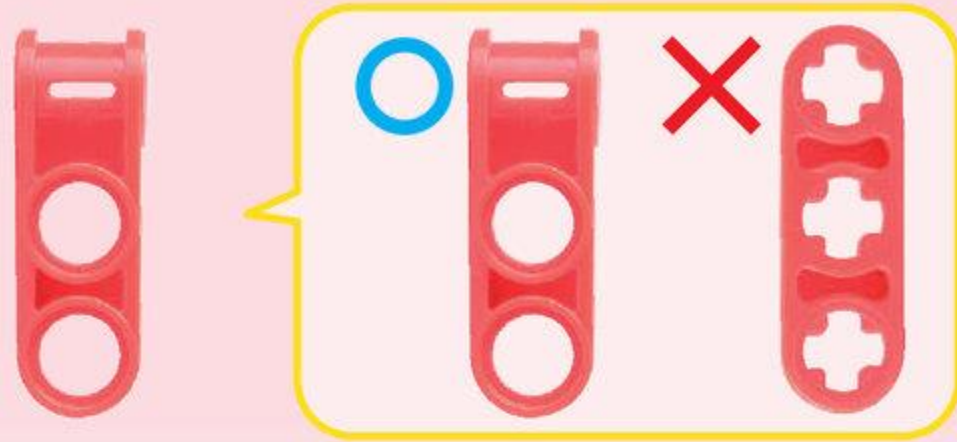

とくちょう

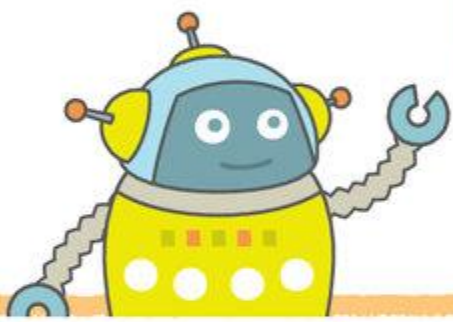

あな
アナのかたちを
みてみよう

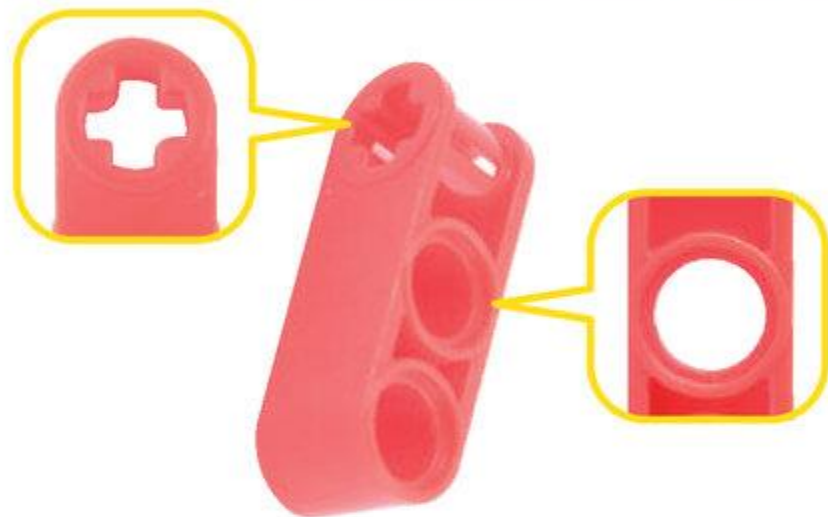

まずたあ マスターしよう

pegとシャフトをそれぞれとりつけられるよ

あな
のアナ

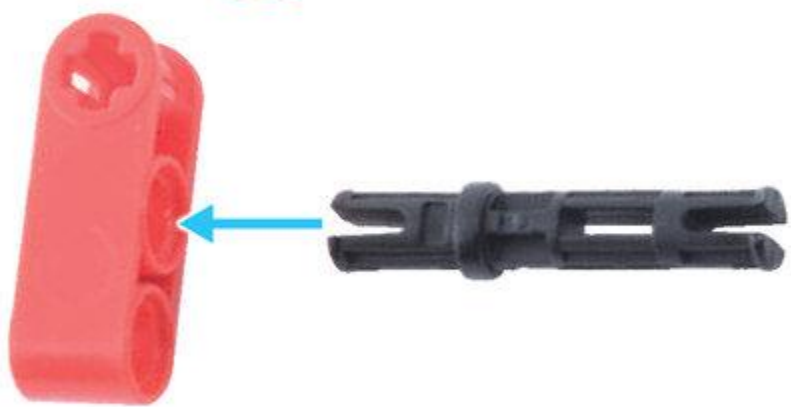

あな
のアナ

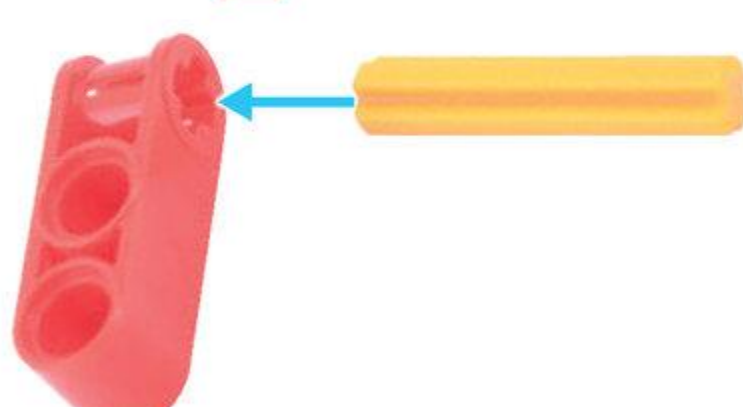

きょうの よてい

めやす 2 ふん

このじゅんばんでつくるよ!

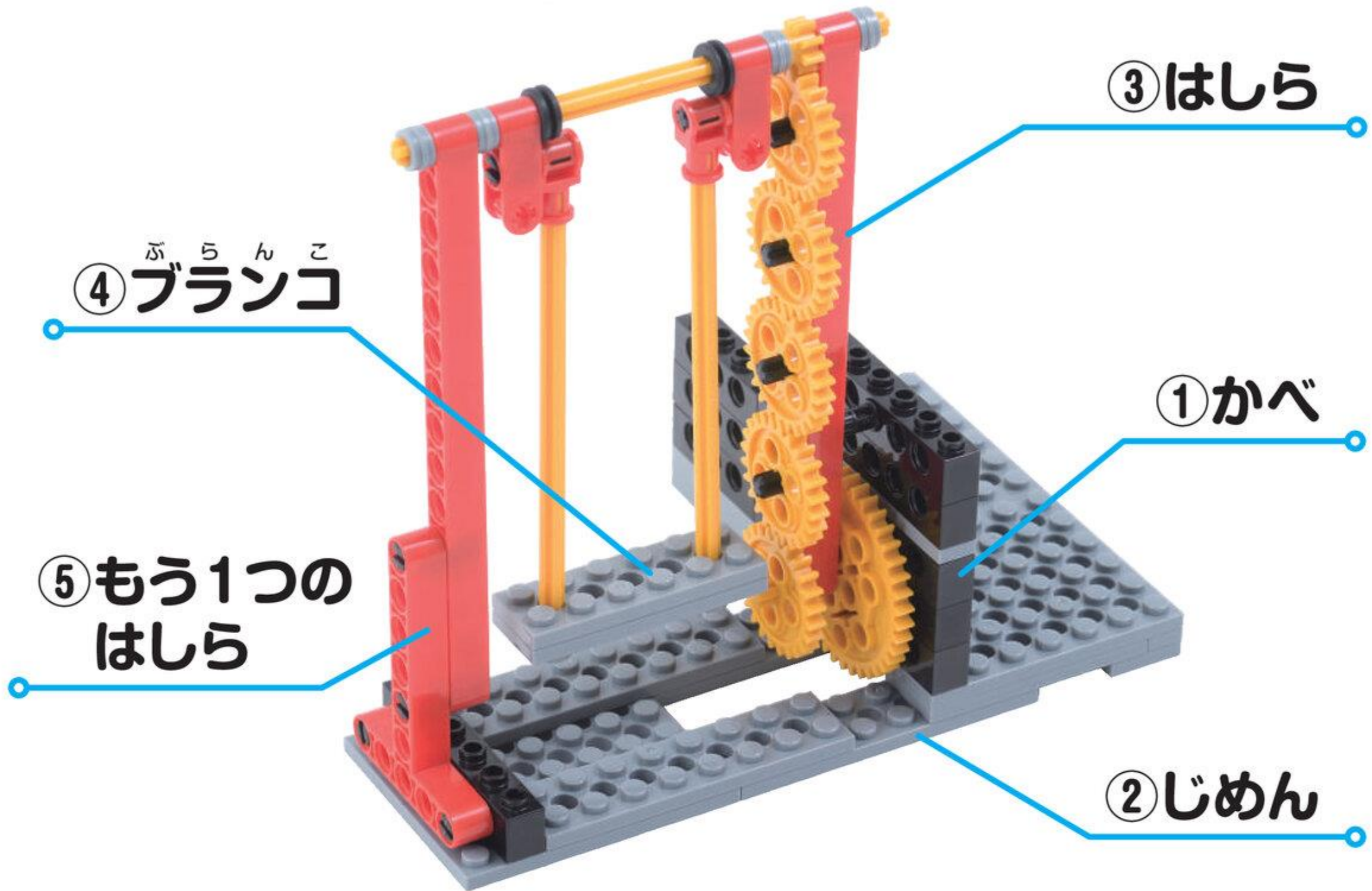

①かべ

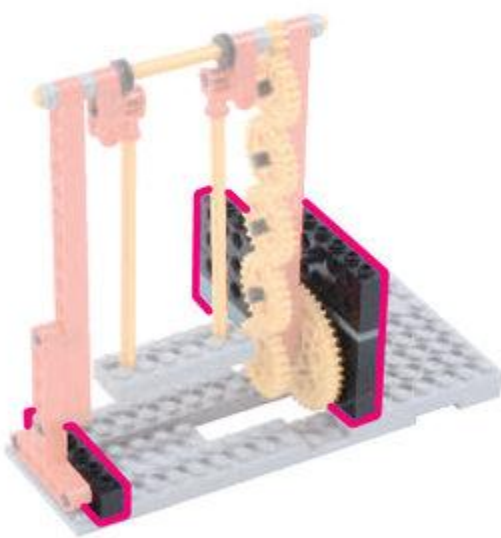

②じめん

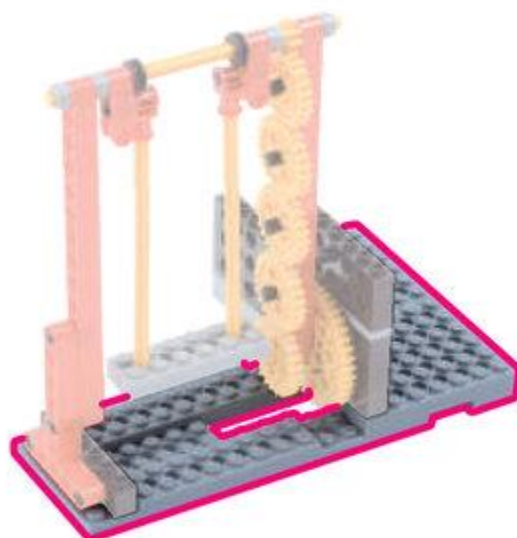

③はしら

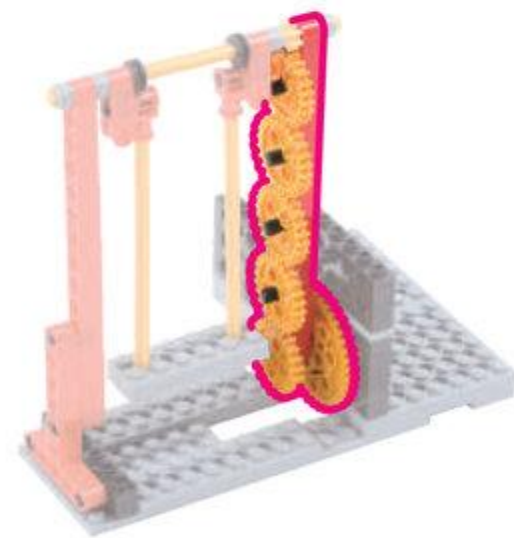

④ブランコ

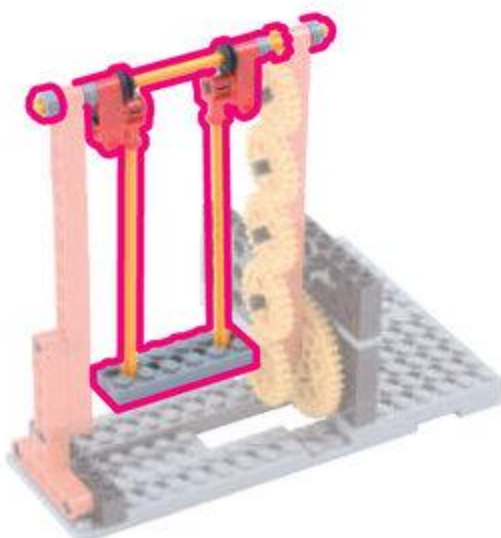

⑤もう1つの はしら

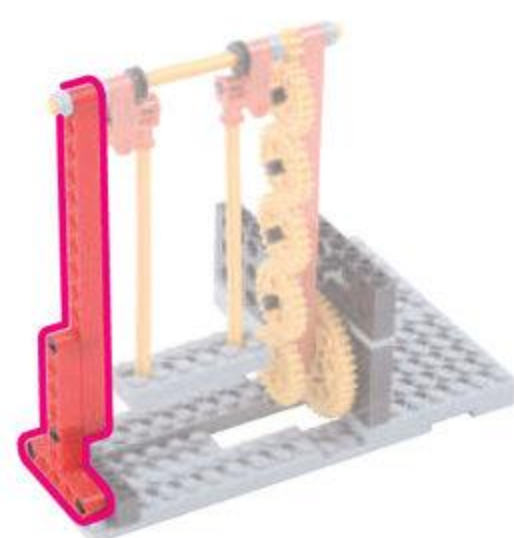

1 かべ めやす 5 ふん

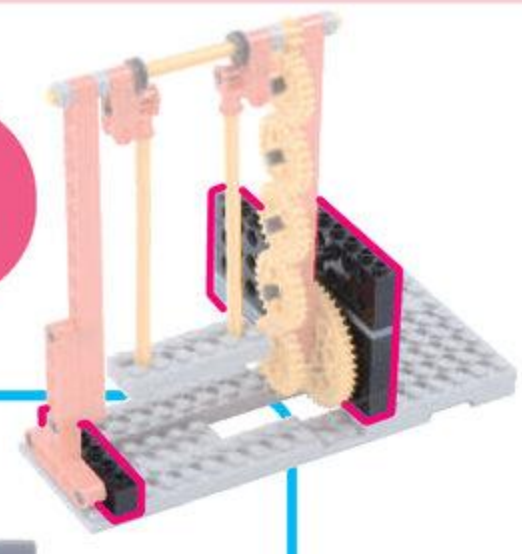

びいむろくほち
ビーム 6 ポチ 2こ



ほそぶれえとろくほち
細プレート 6 ポチ 1こ



1



びいむはちぼち
ビーム 8 ポチ 3こ



びいむよんぼち
ビーム 4 ポチ 3こ

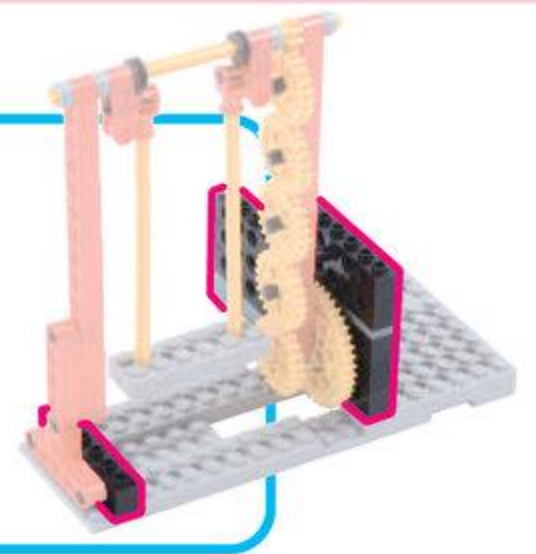

2

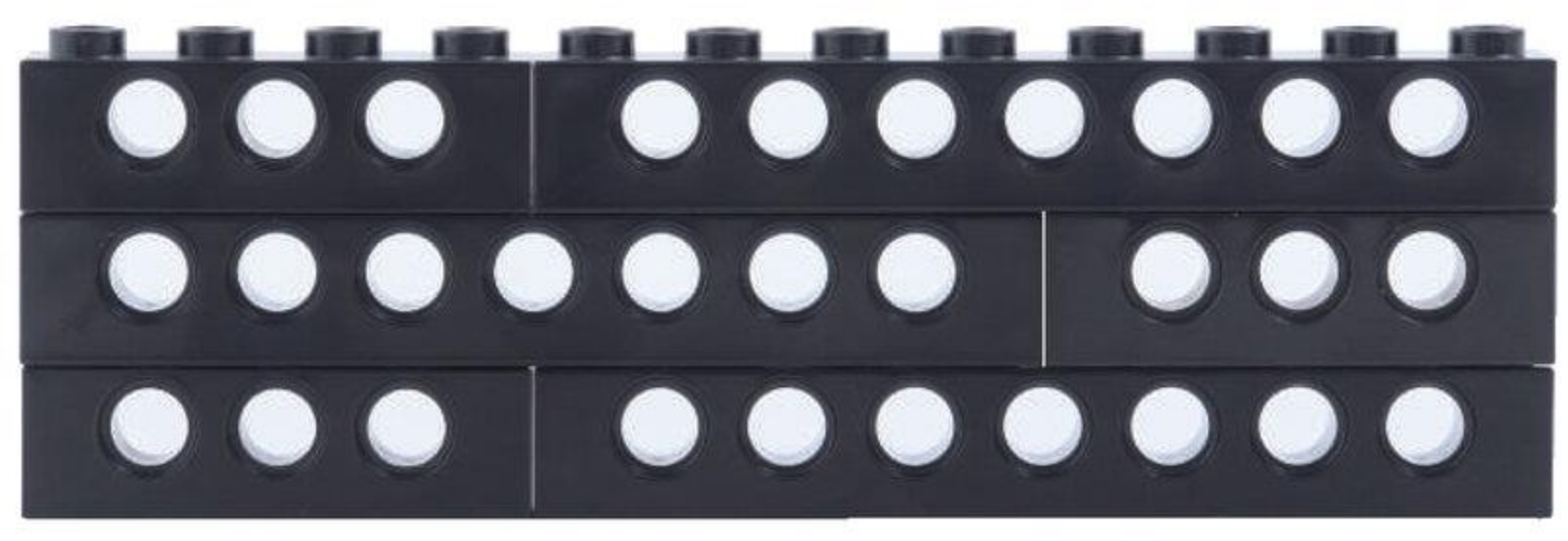
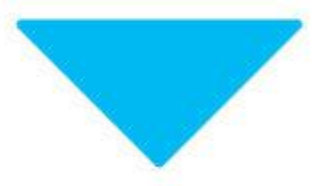
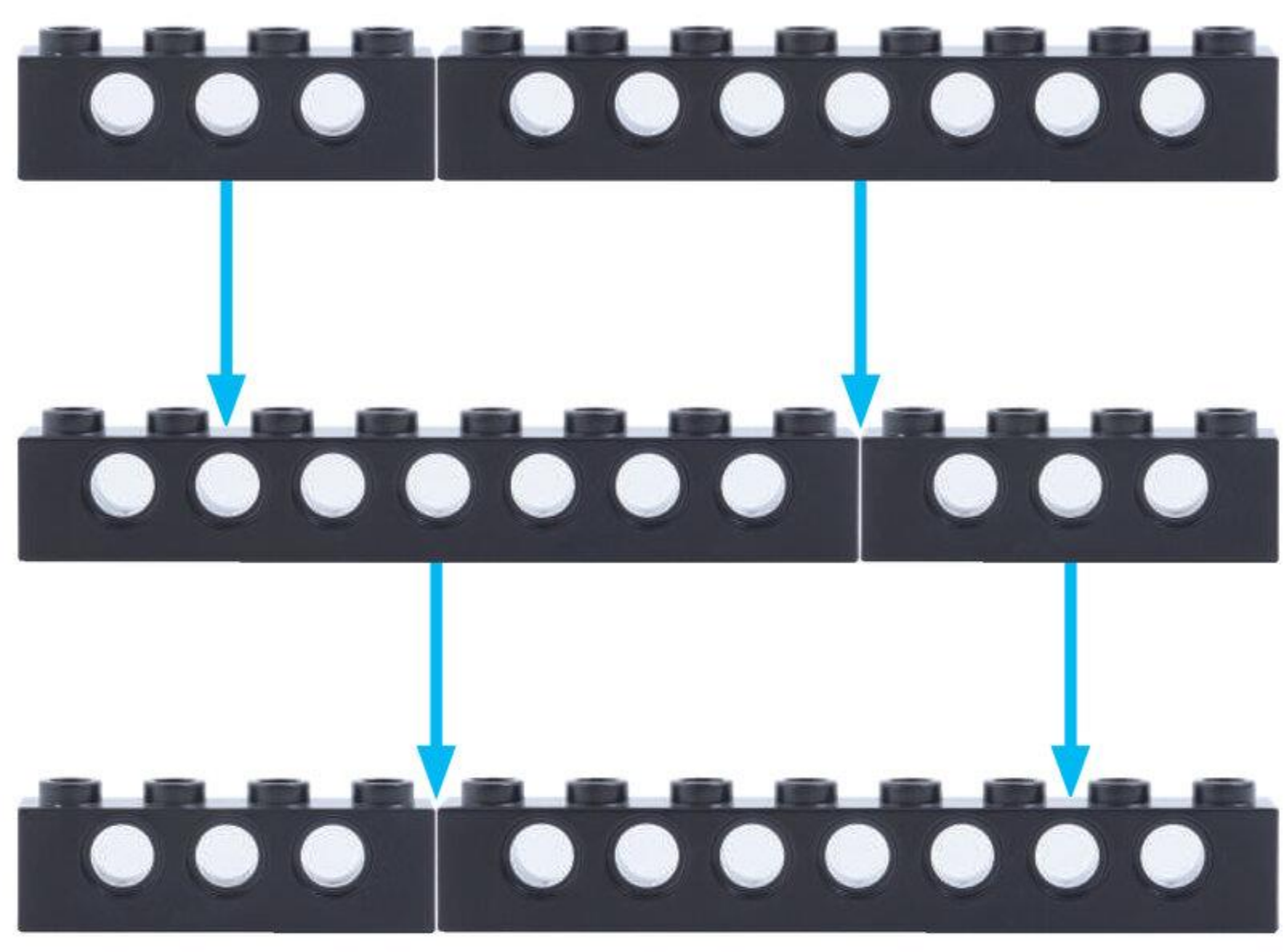

3

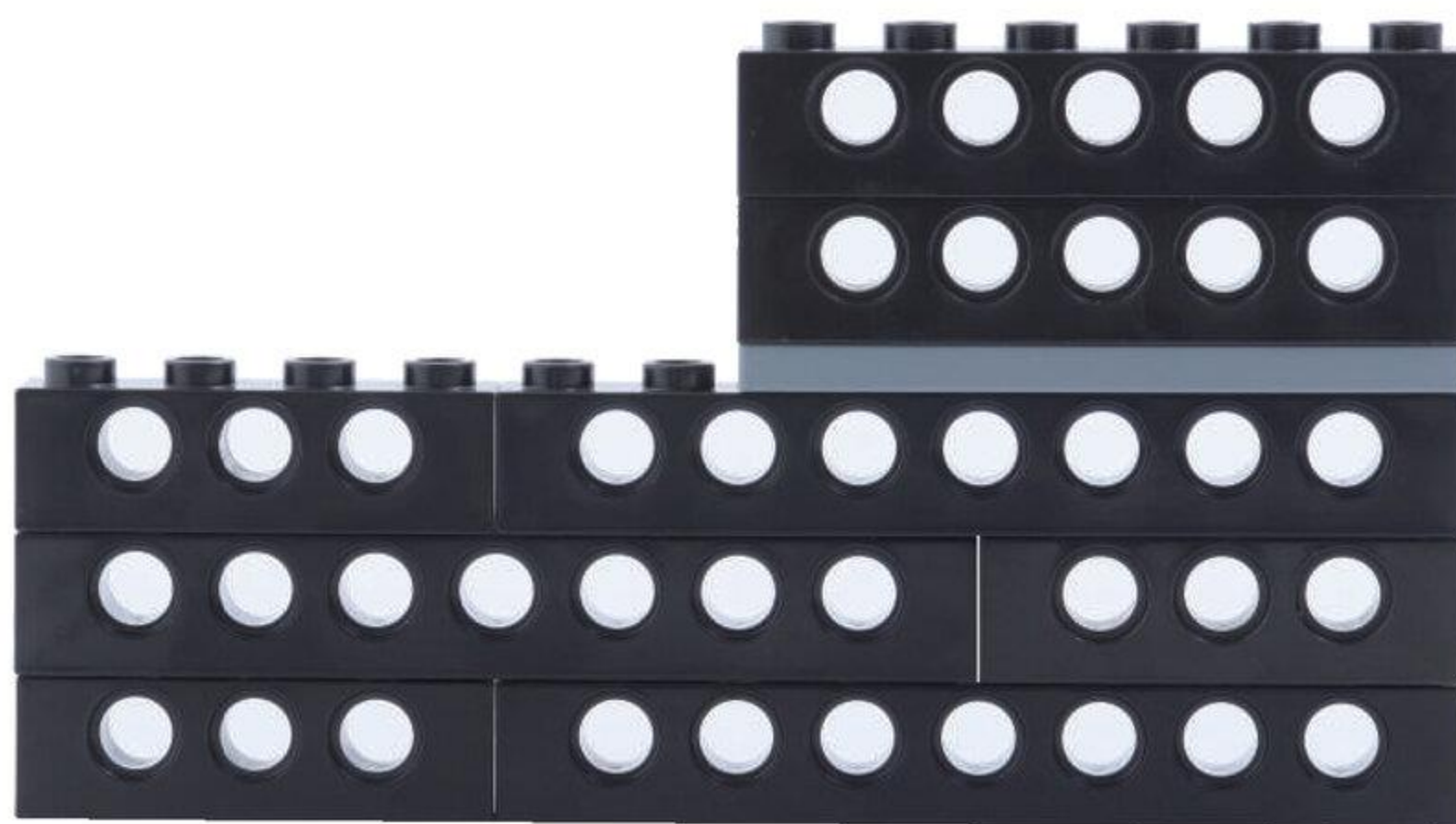

かべが
かんせい!

やったね!

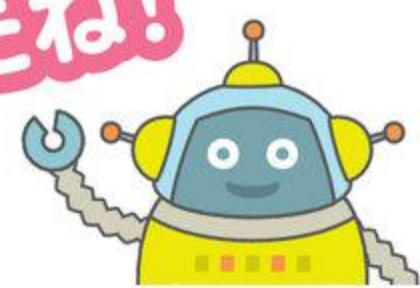

2 じめん

めやす 15 ぶん

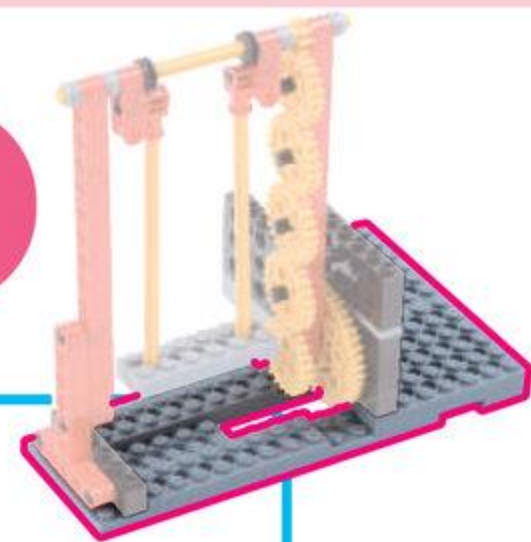

ふれえとろ
プレートL 1こ

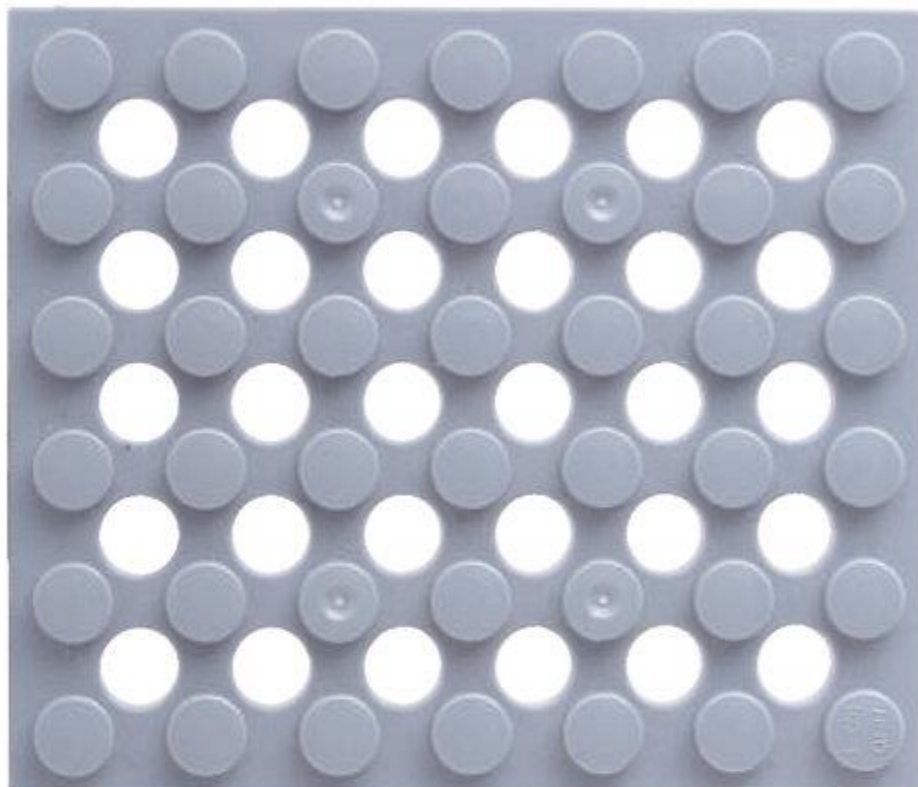

ふとふれえとはちほち
太プレート8ポチ 4こ



1

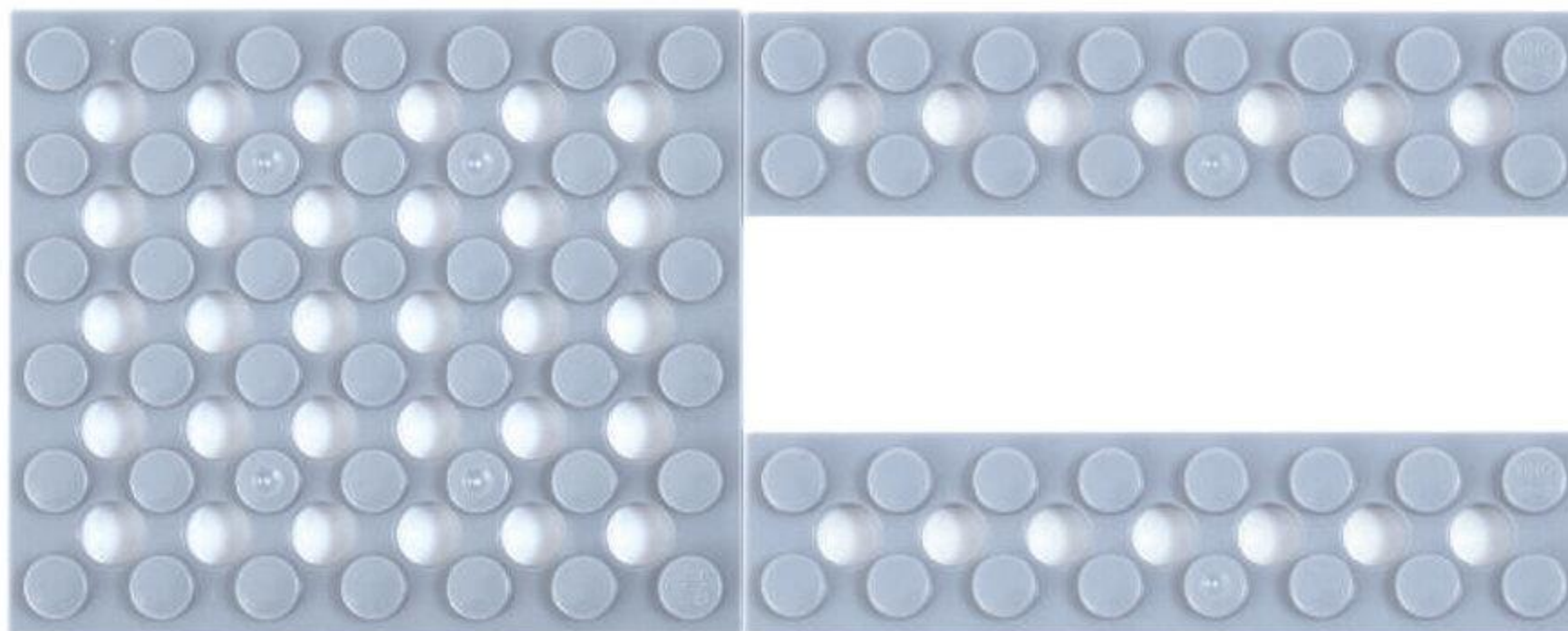

2

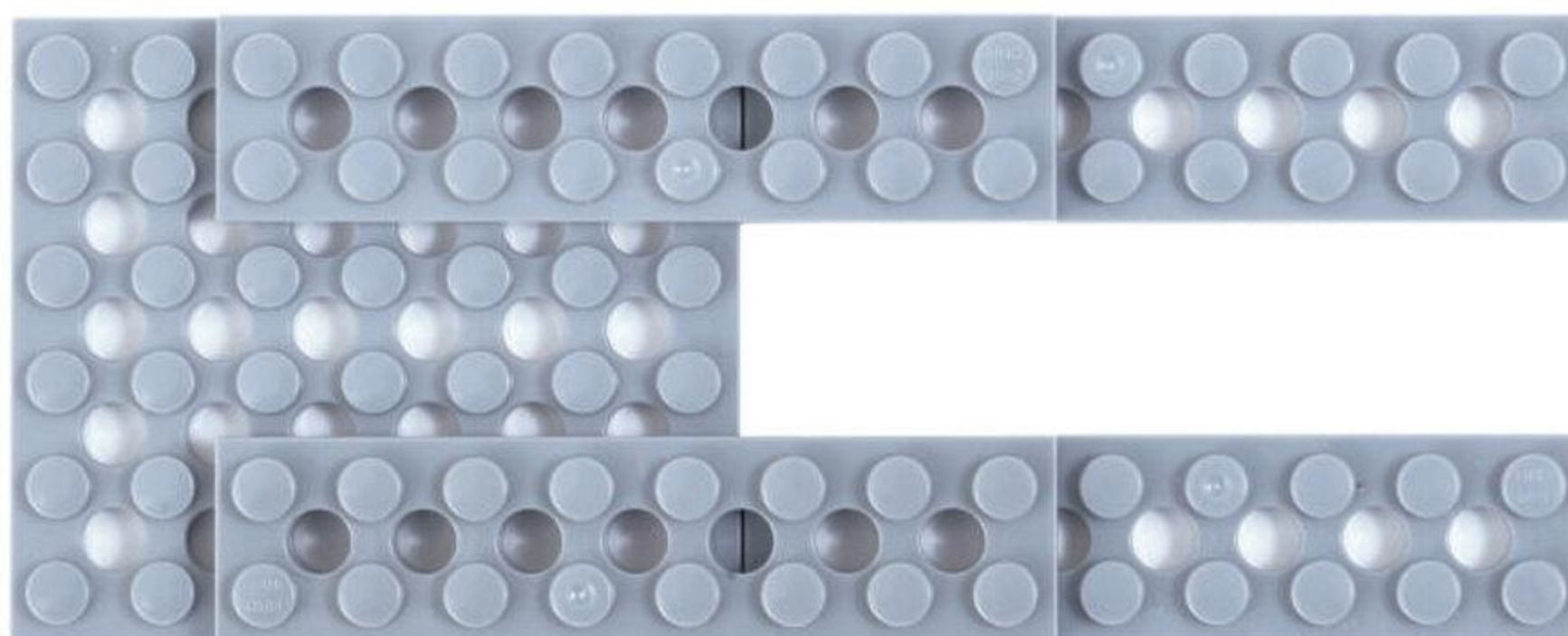
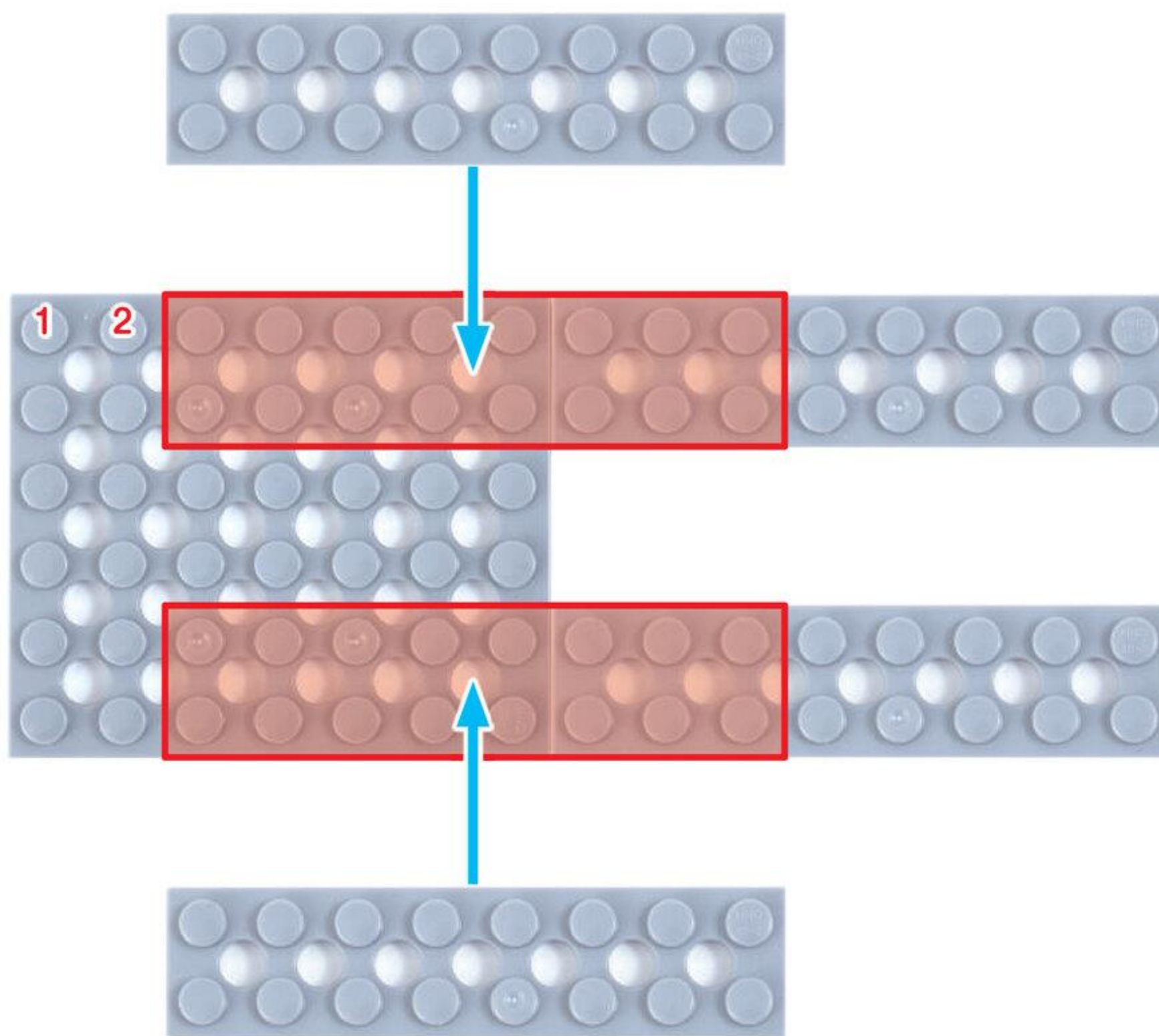
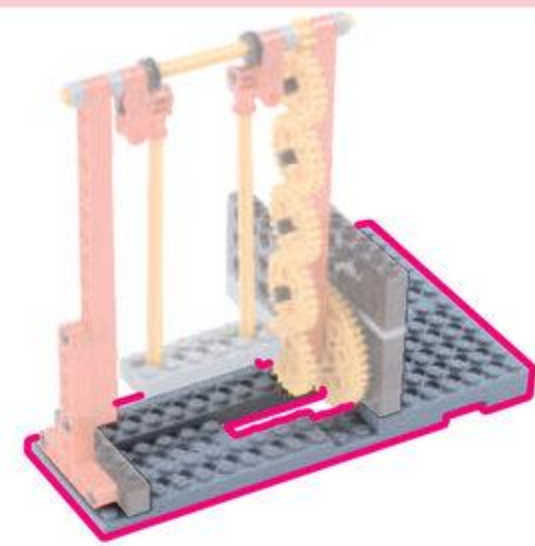

ふとぶれえとろくほち
太プレート 6 ポチ 1 こ



ふとぶれえとはちほち
太プレート 8 ポチ 1 こ

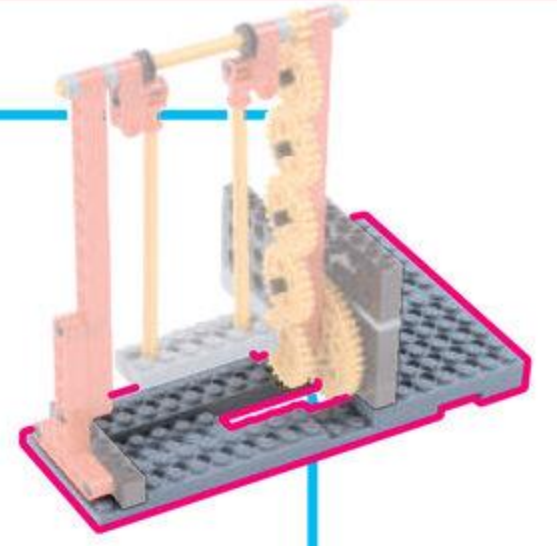

3

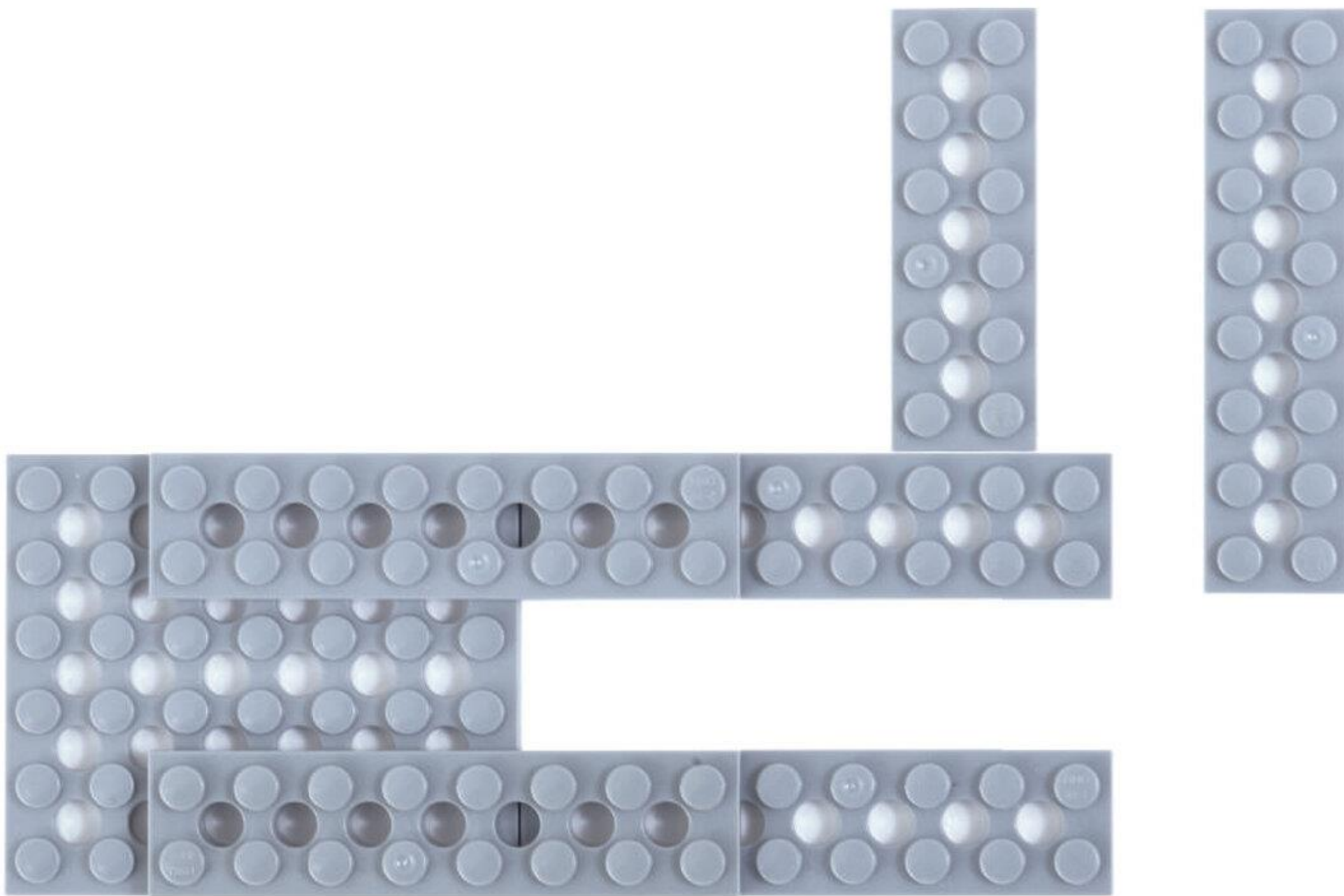

4

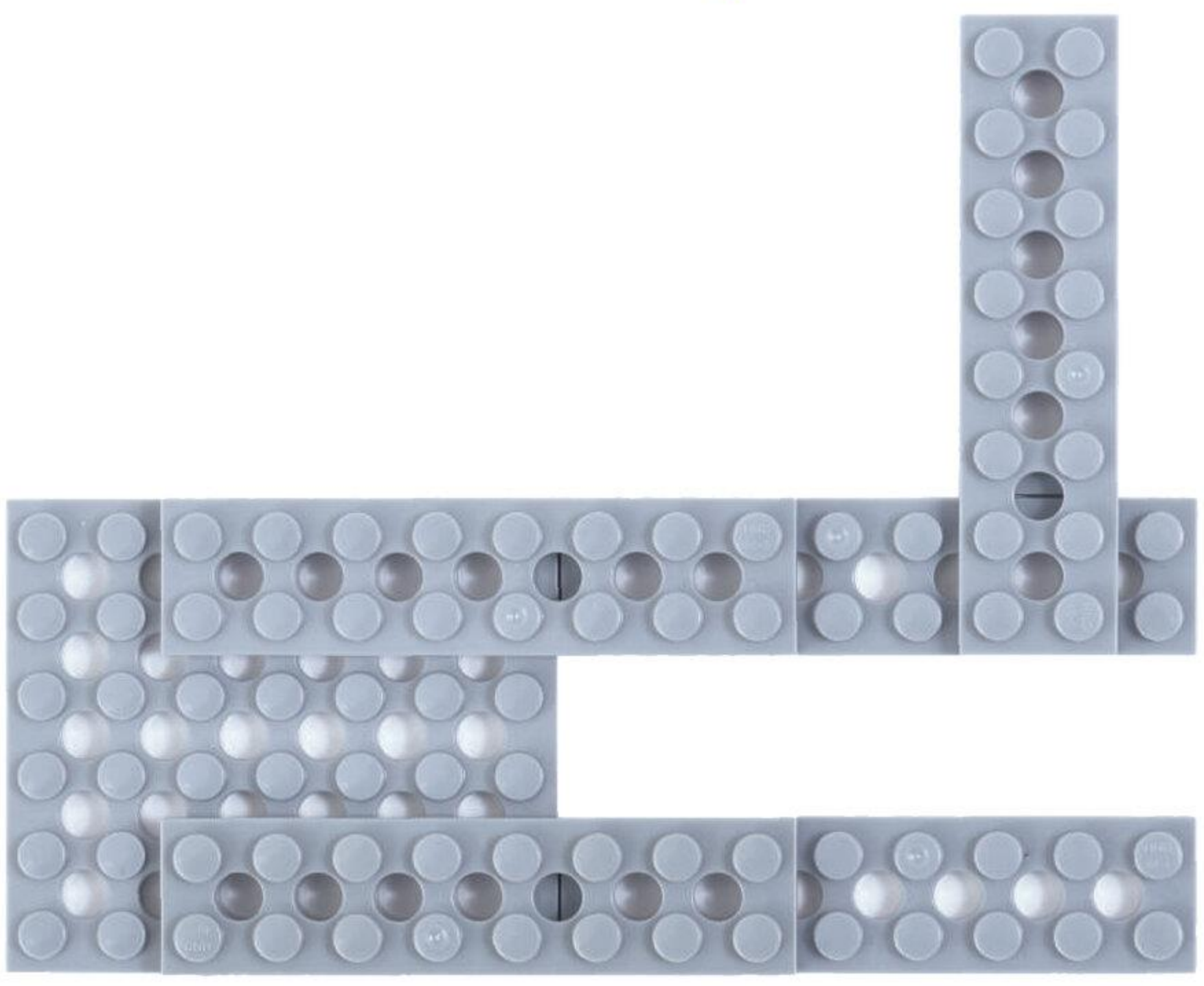
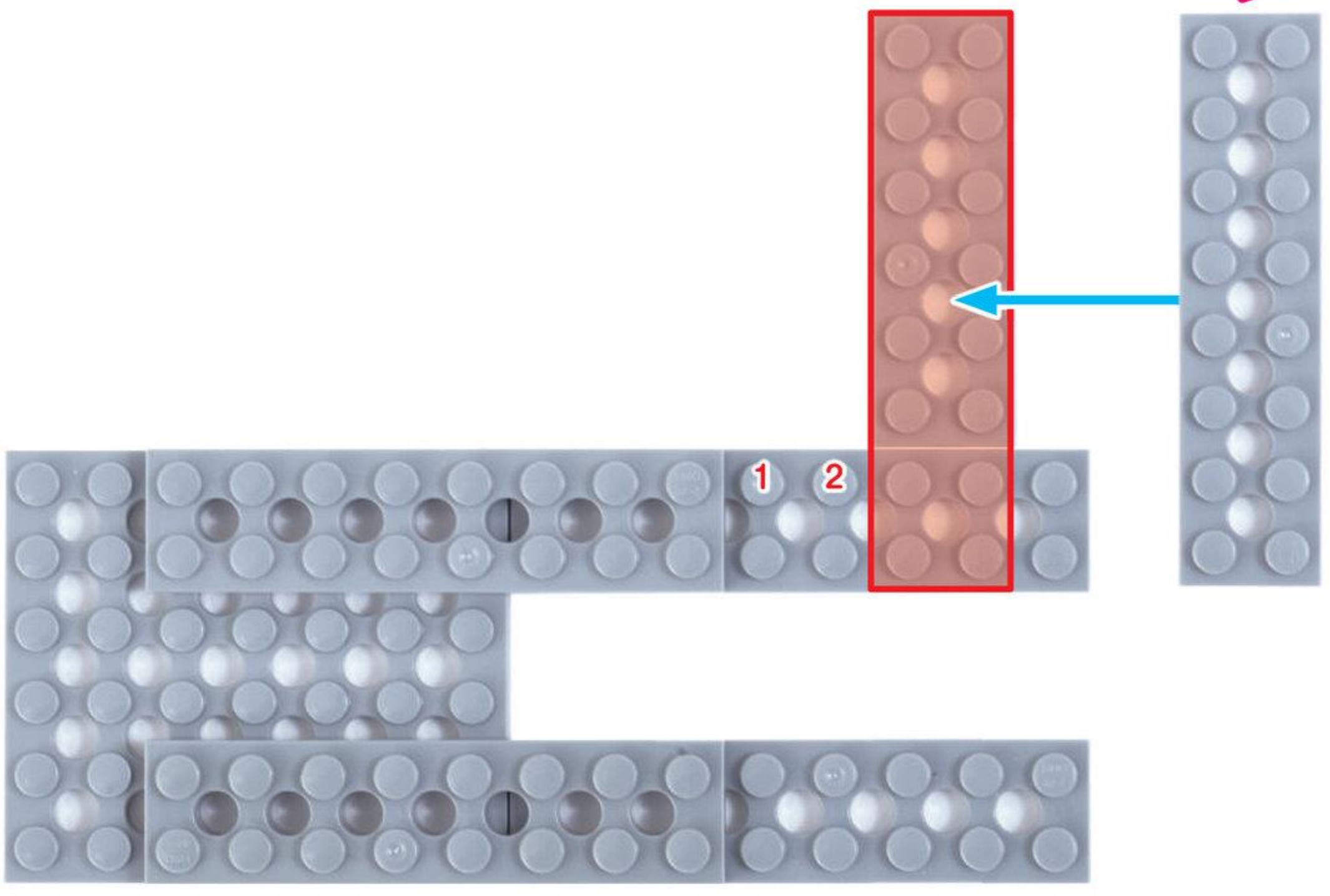
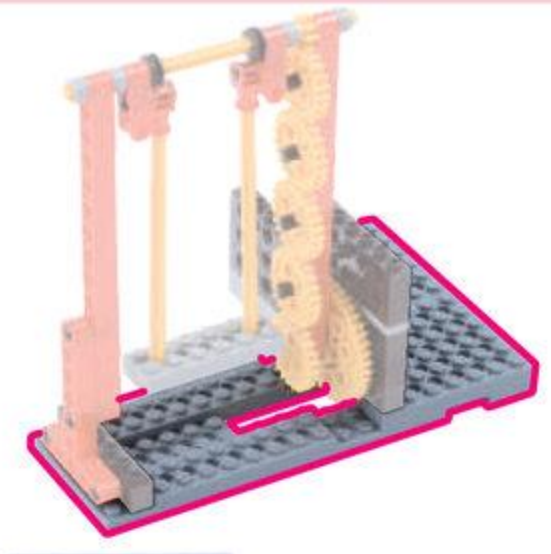

ふとぶれえとよんぼち
太プレート 4 ポチ 1 こ



ふとぶれえとはちぼち
太プレート 8 ポチ 1 こ

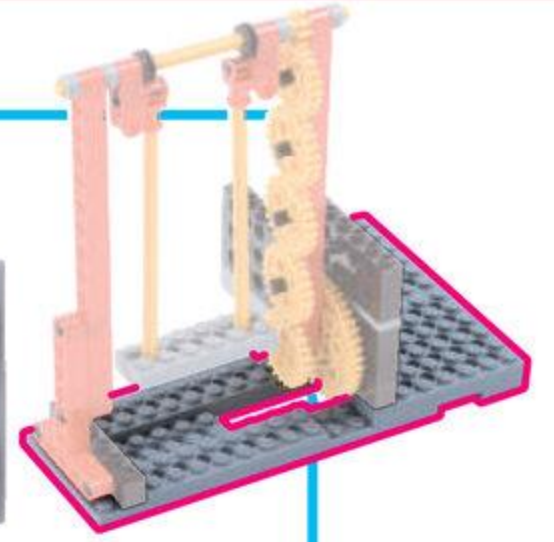

ふとぶれえとろくぼち
太プレート 6 ポチ 1 こ



ほそぶれえとろくぼち
細プレート 6 ポチ 1 こ



5



6

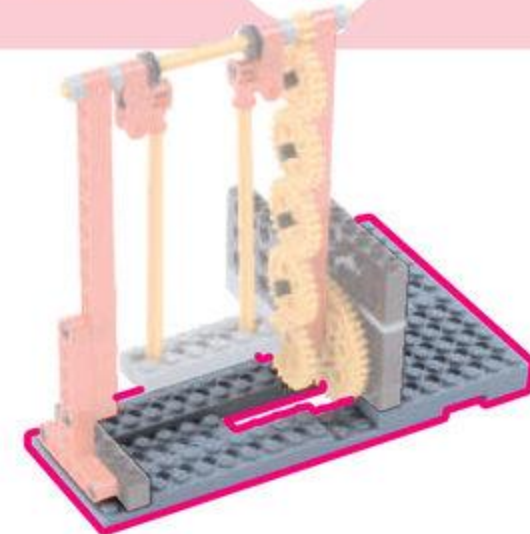
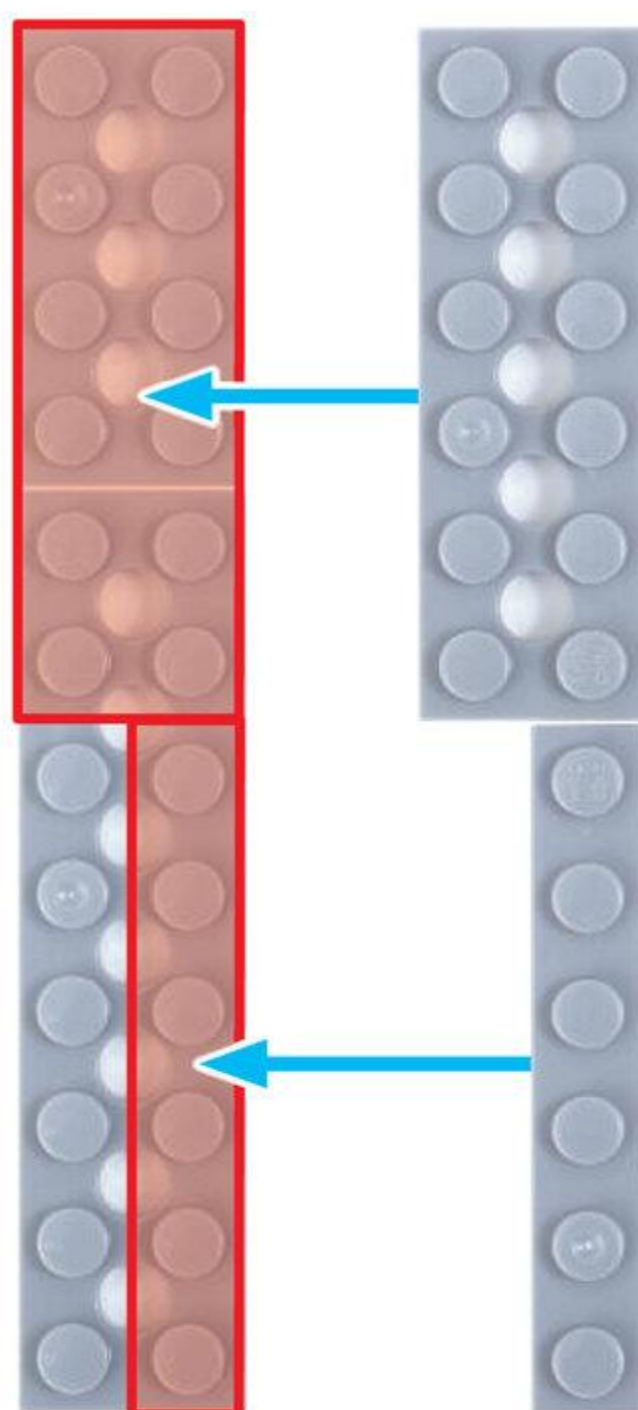

ふとぶれえとろくほち
太プレート 6 ポチ 1こ



ふとぶれえとよんほち
太プレート 4 ポチ 1こ

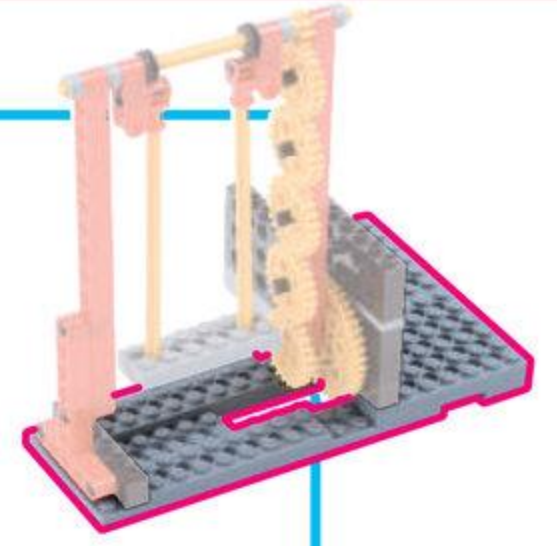

7

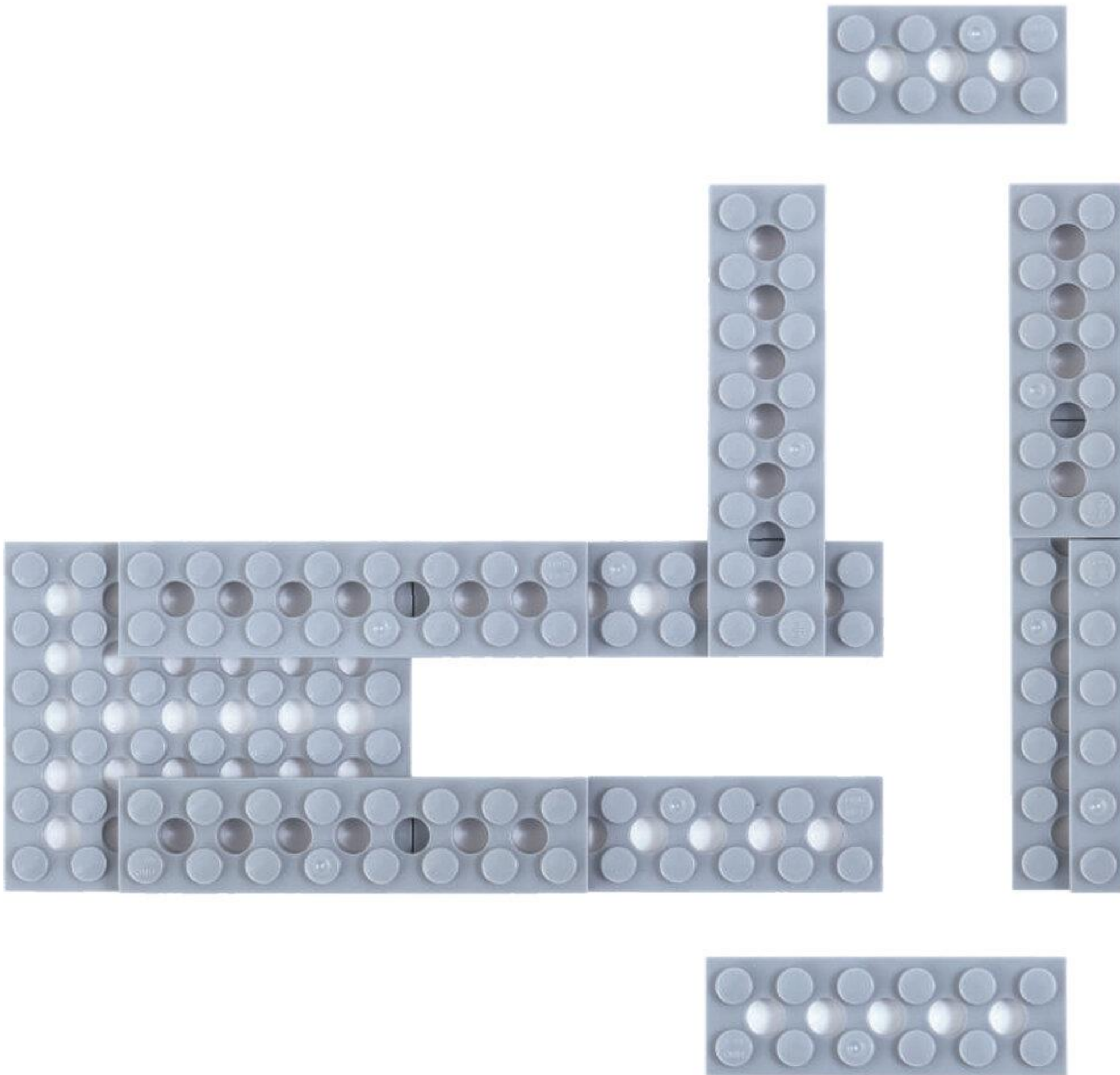

8

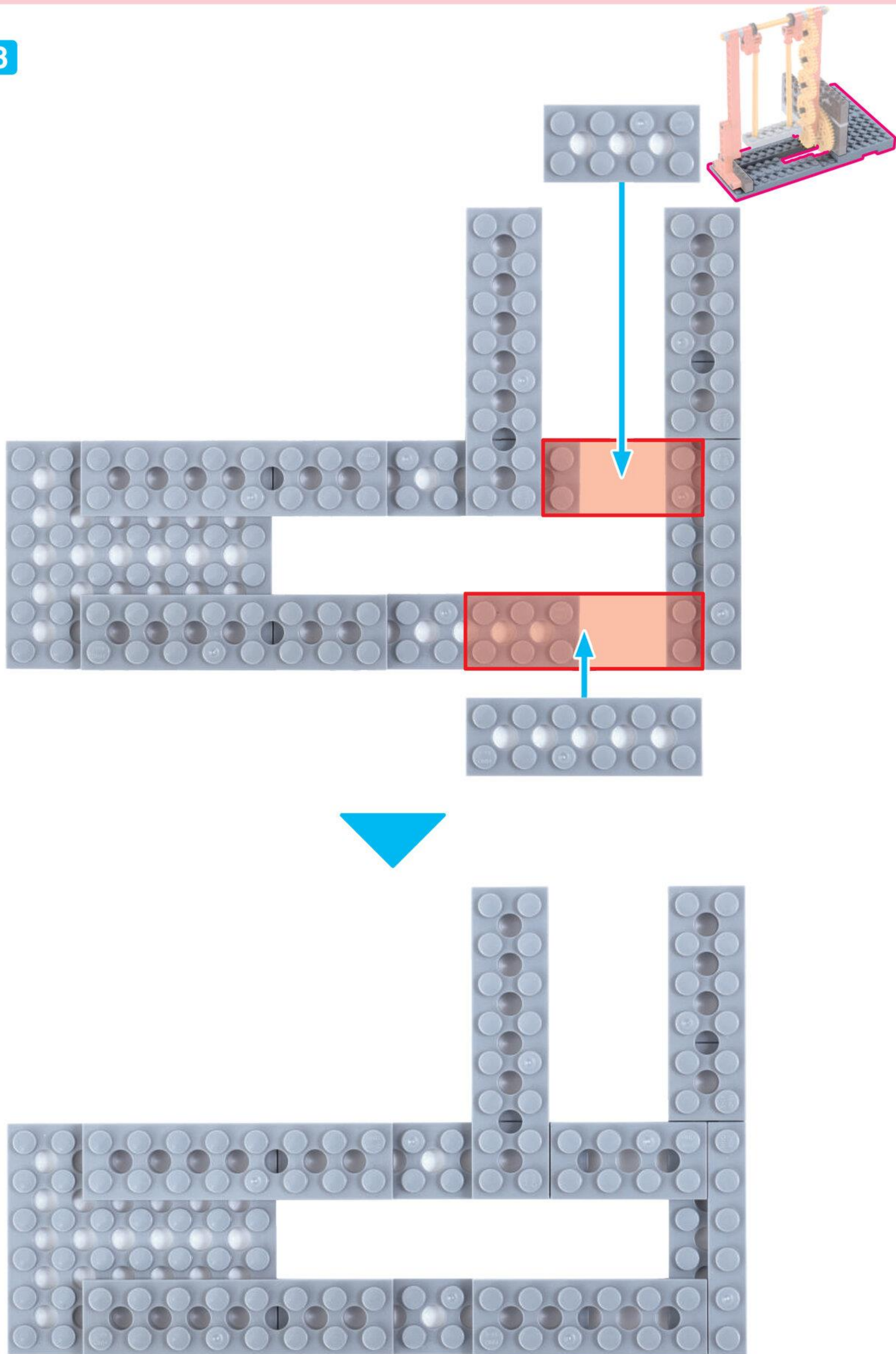

ぶれえとる
プレート 2こ

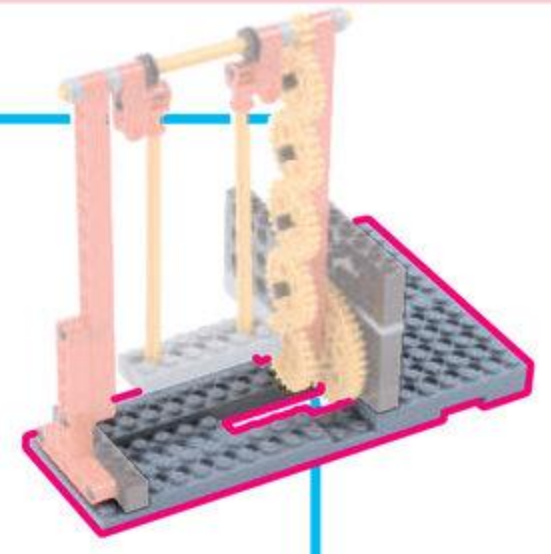
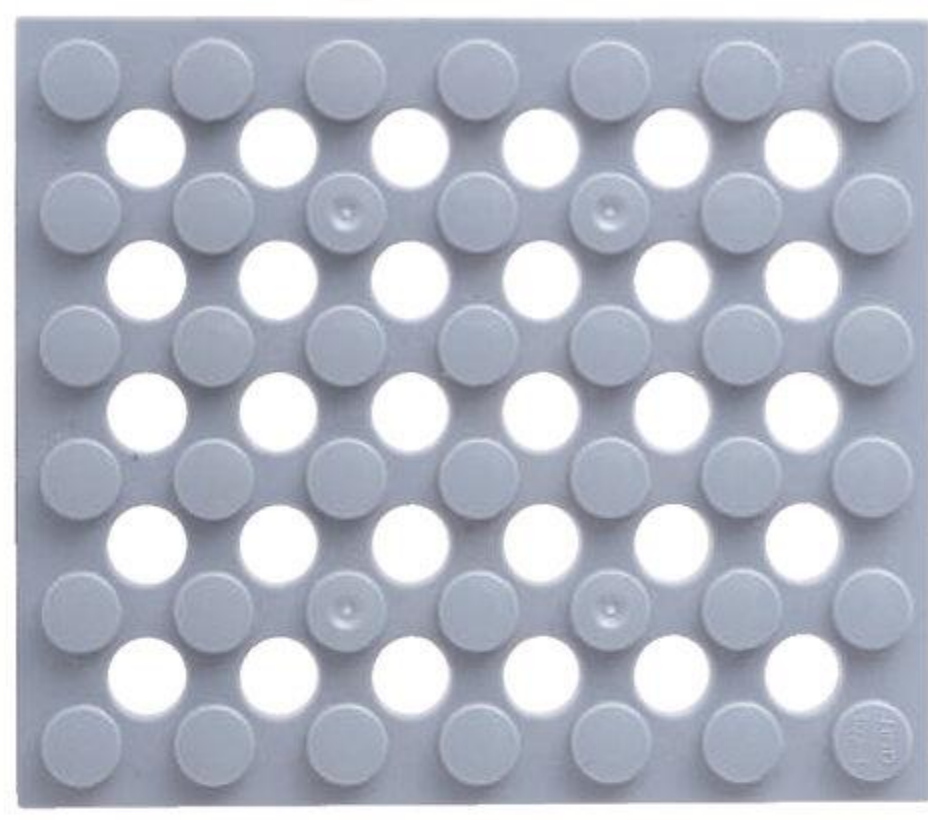

9

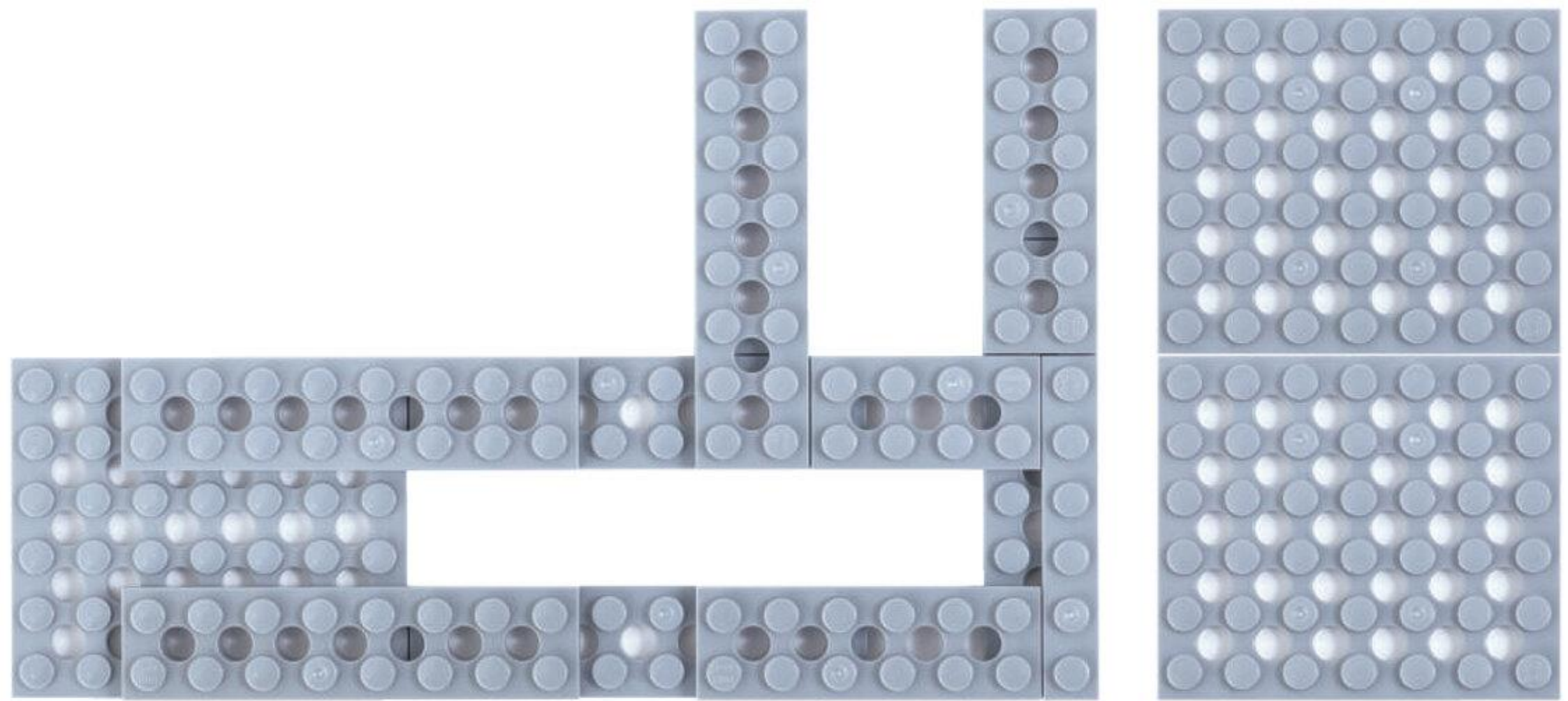

10

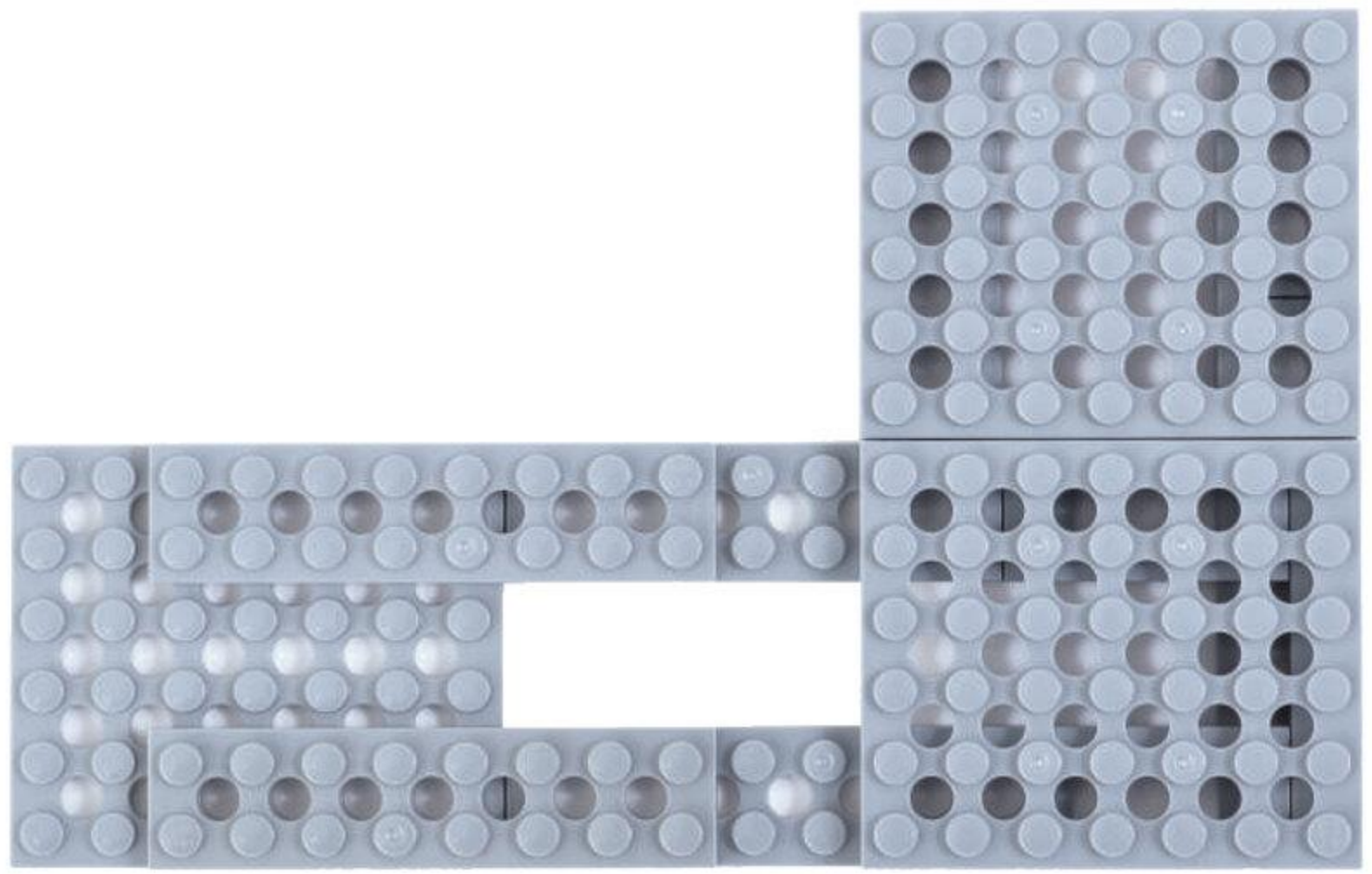
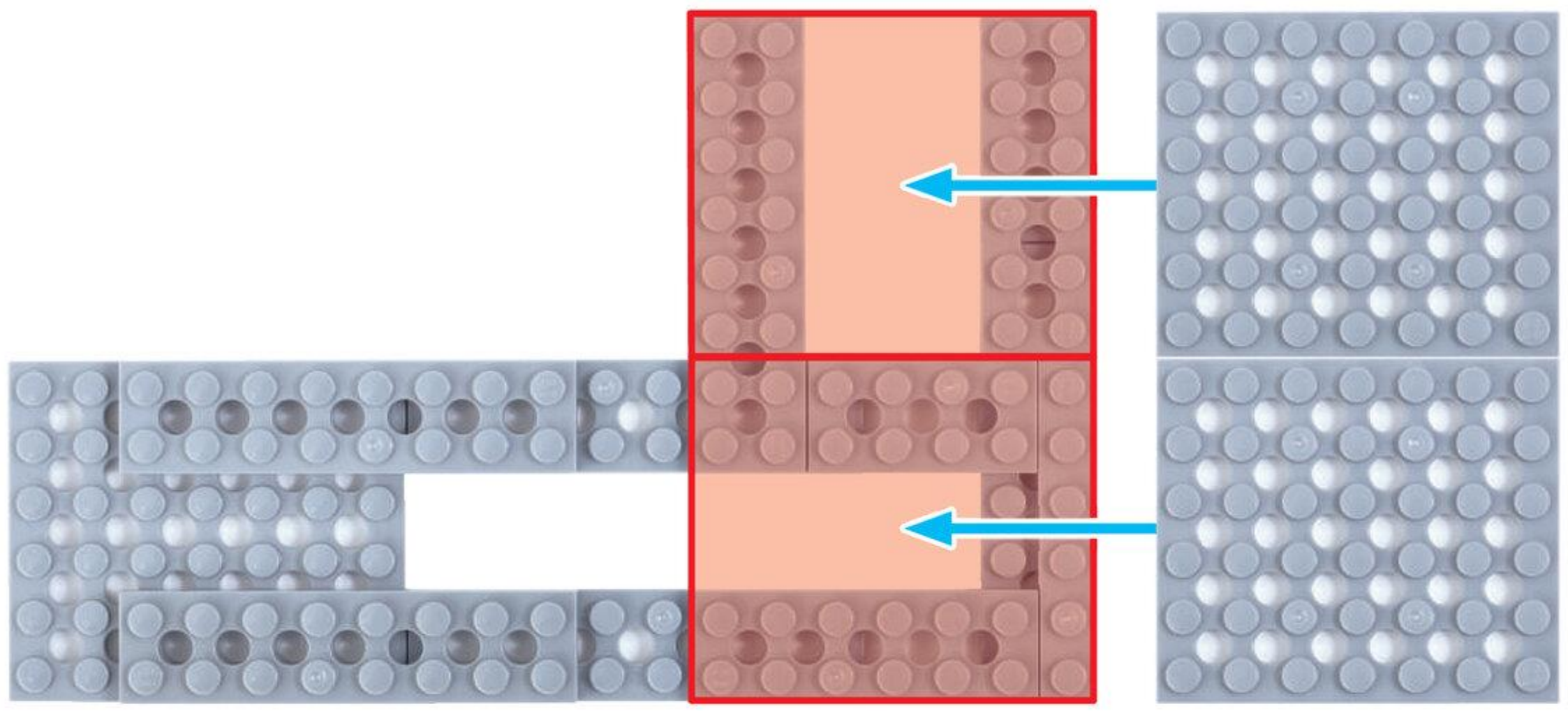

びいむろくほち
ビーム6ポチ 1こ

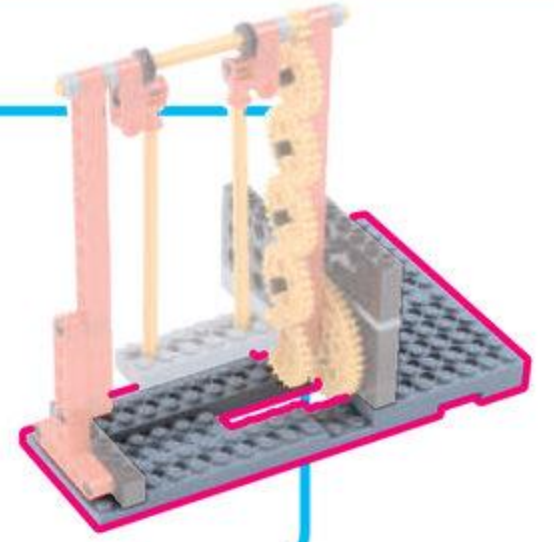

11

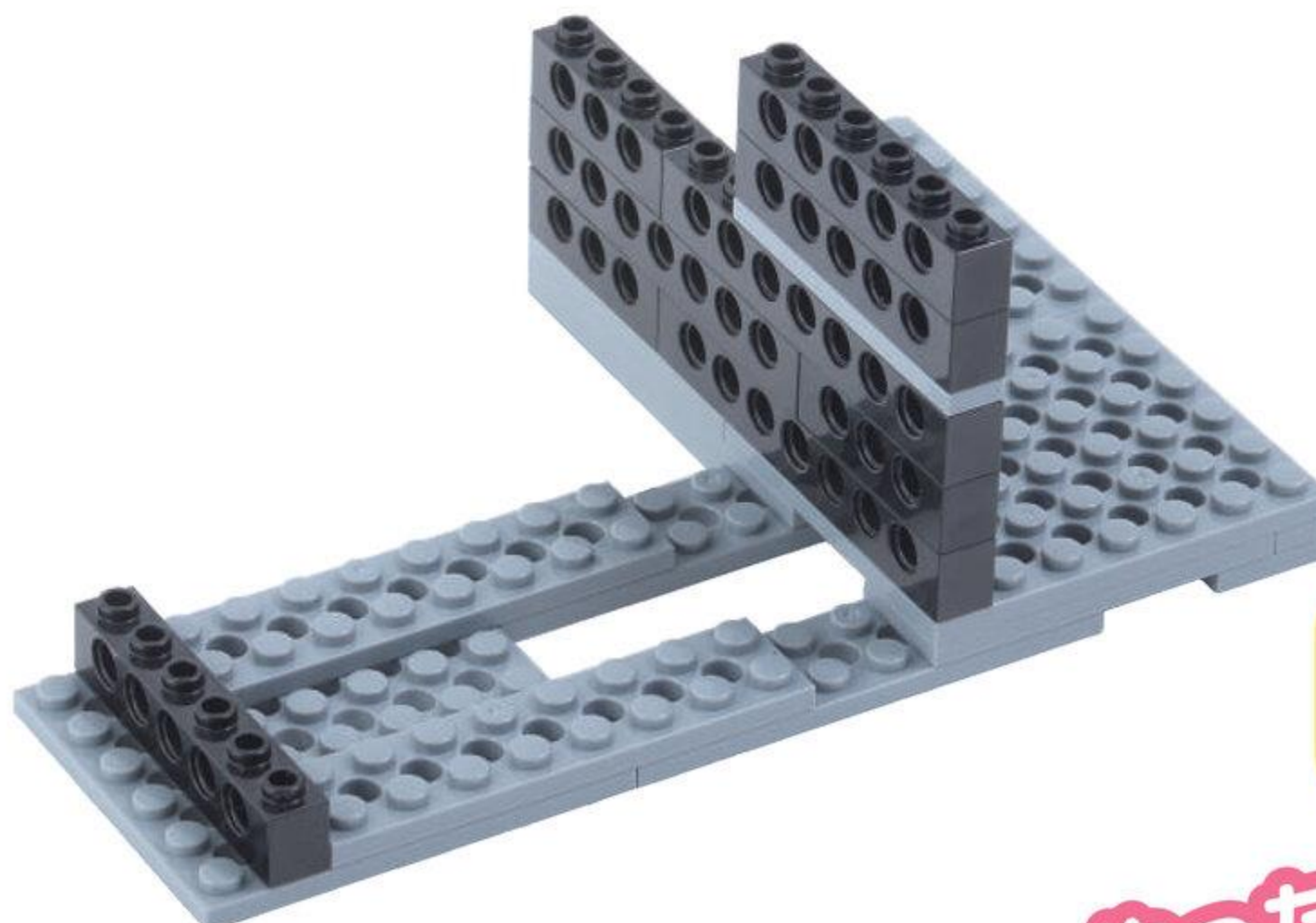
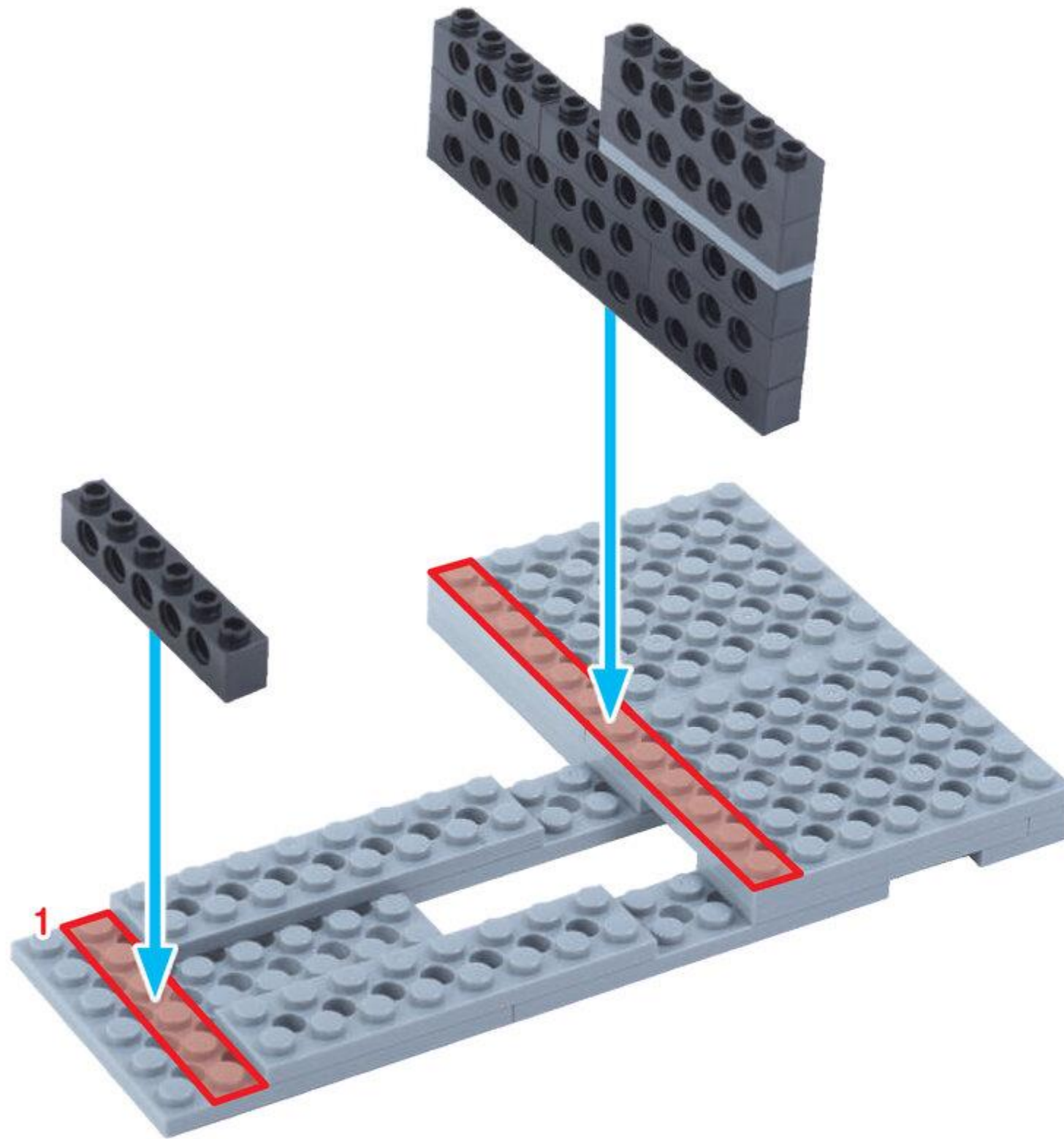

じめんが
かんせい!

やったね!

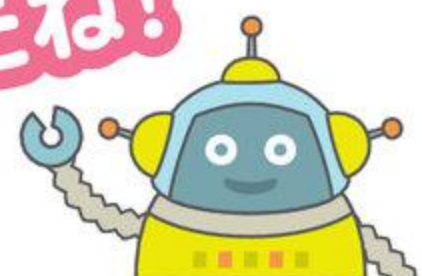

3

はしら

めやす 10 ぶん

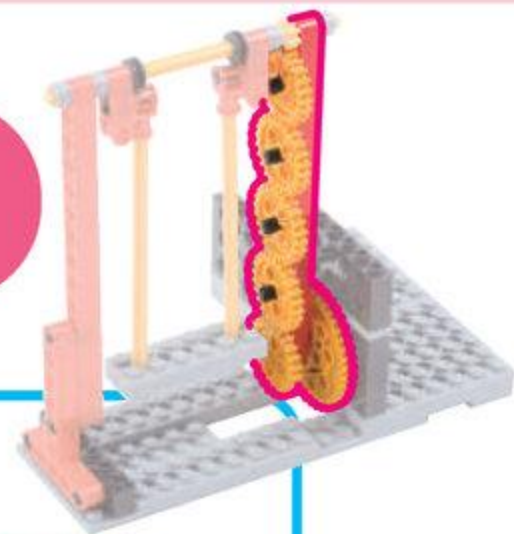

ろっど 15 アナ 1 こ



シャフト 5 ポチ 1 こ



ながさに
ちゅうい

シャフトペグ 4 こ



ペグ 1 こ



1

むきに ちゅうい



こちらを さしこむ

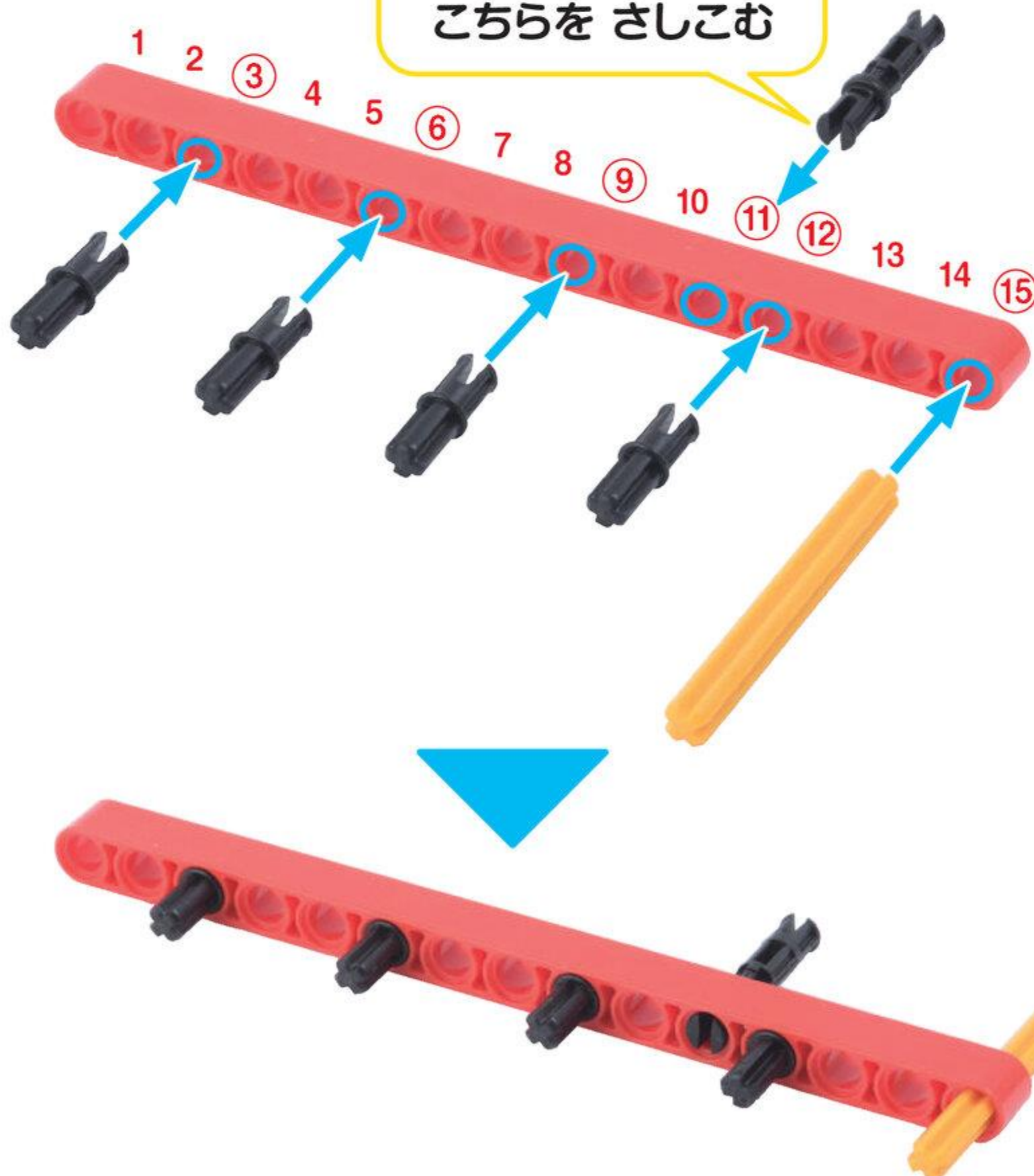

ギア L 1こ

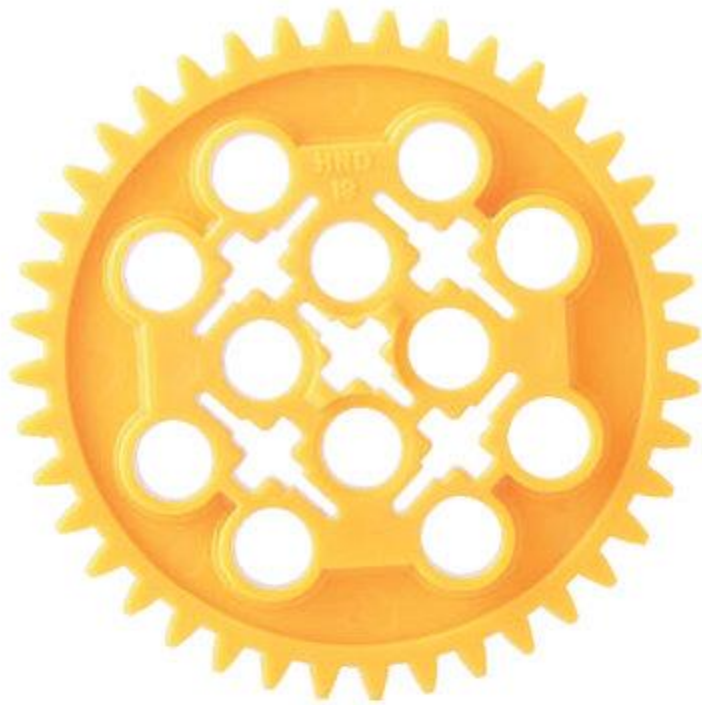

ギア M 5こ

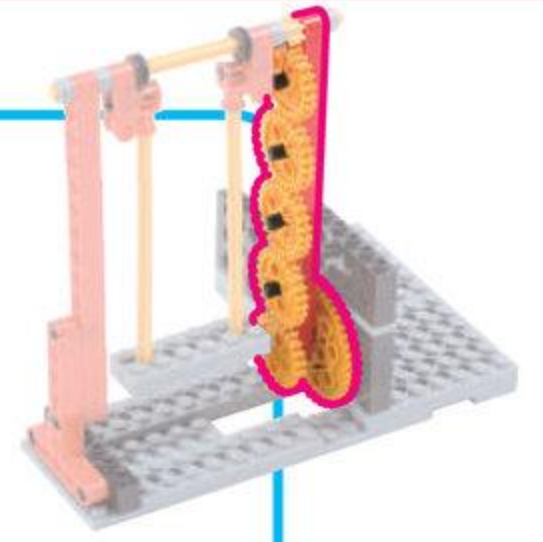
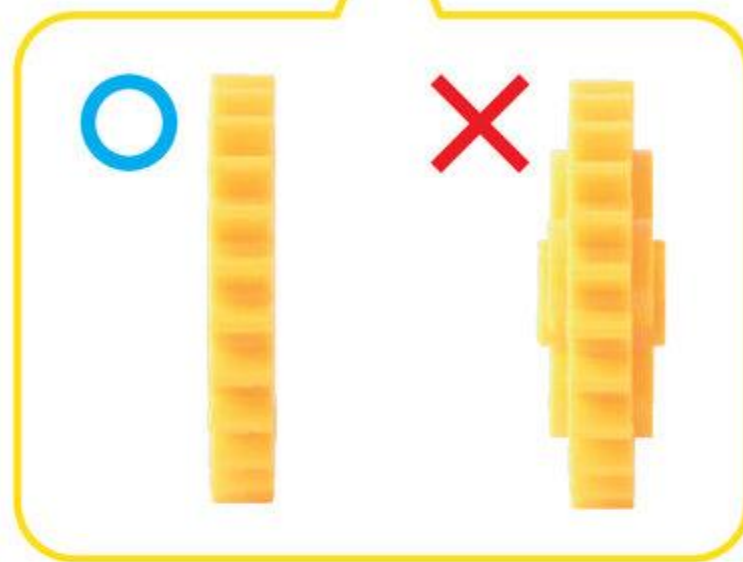
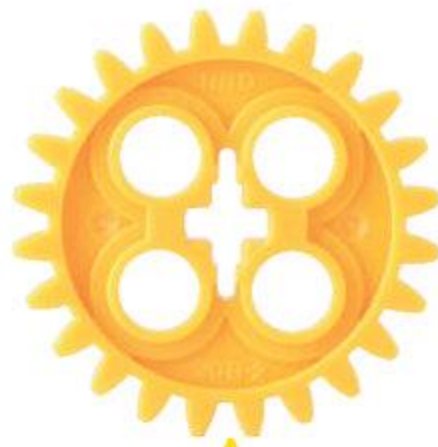

2

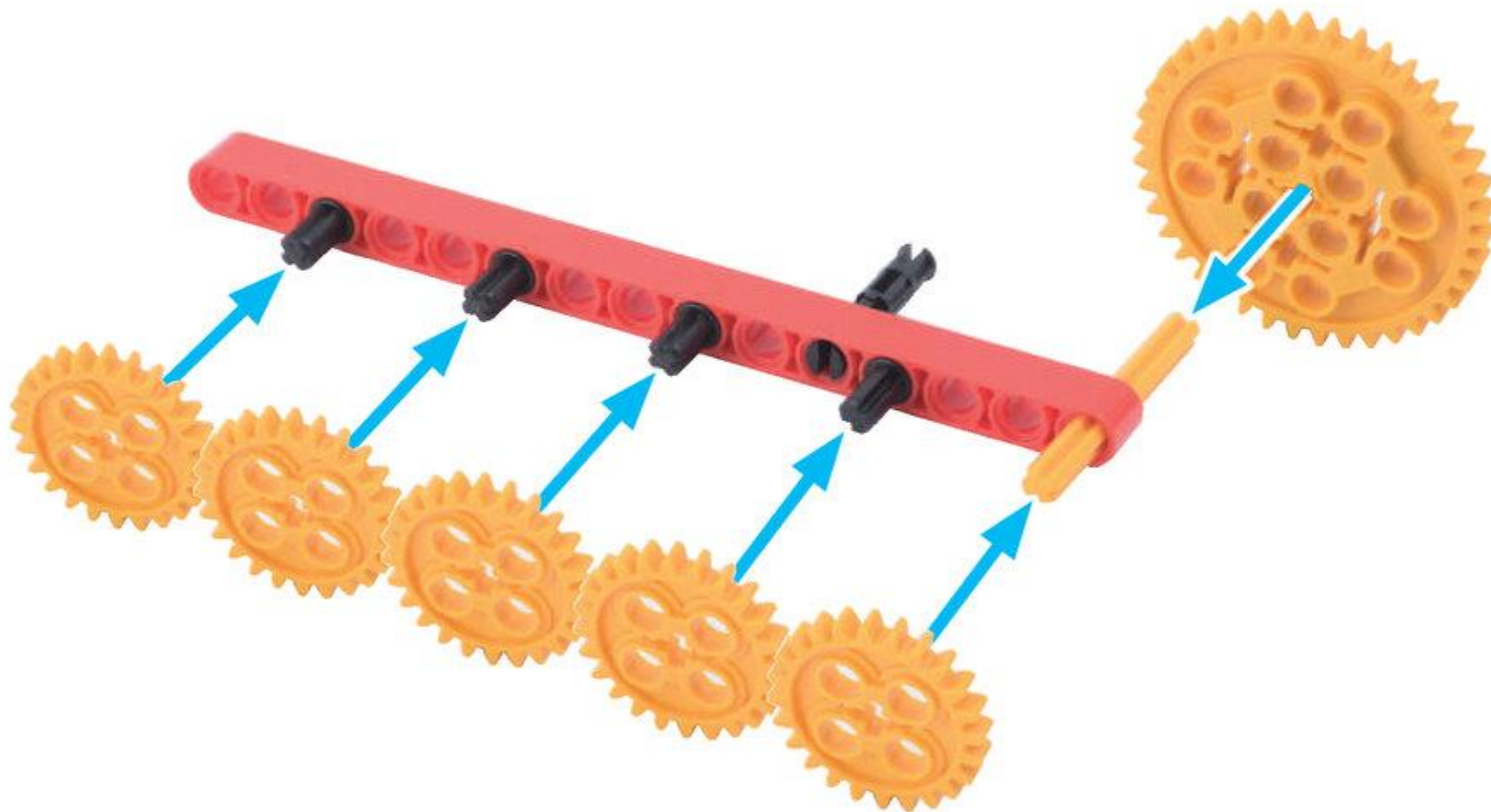

くるくるまわるように
とりつけよう



3

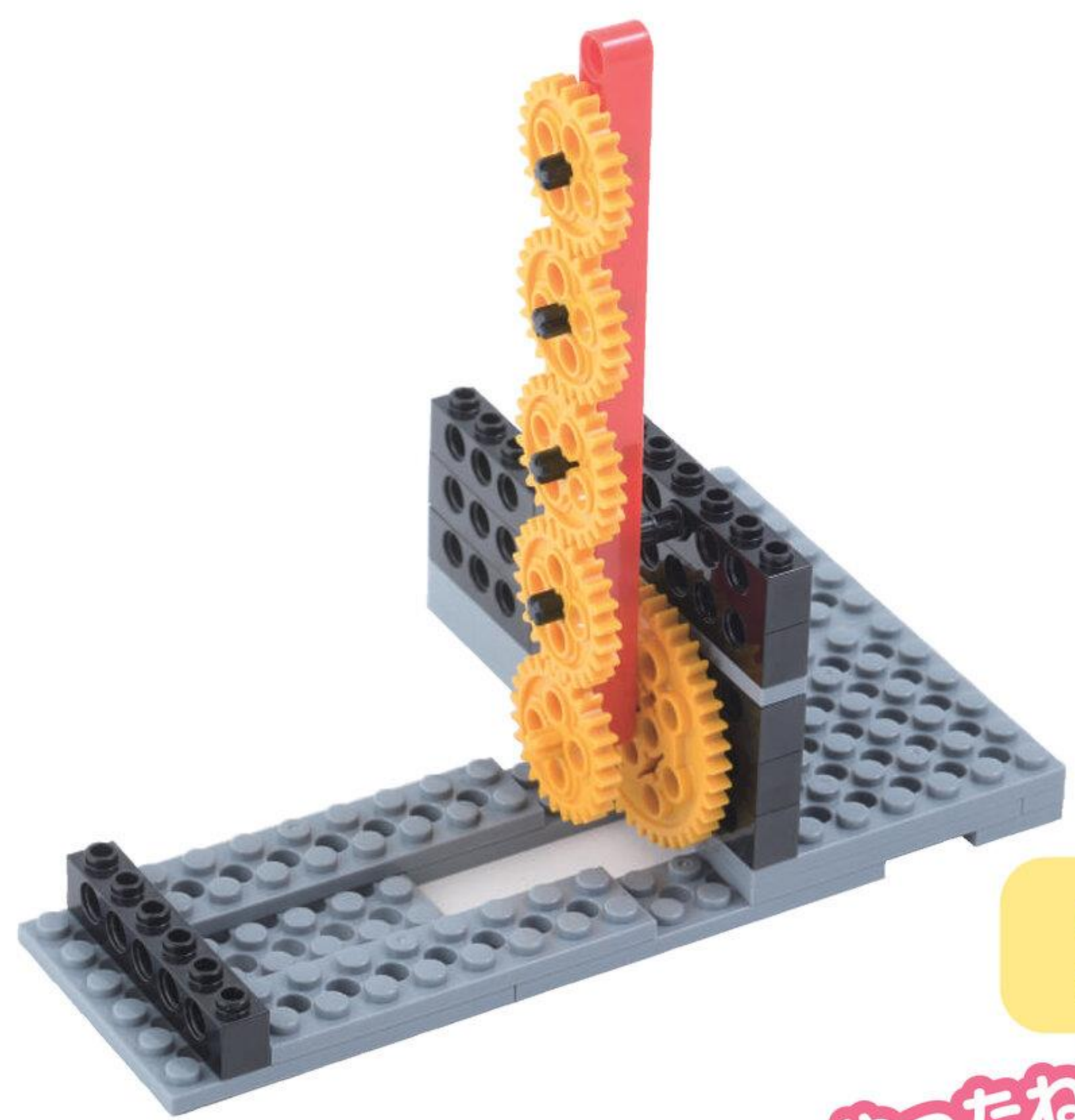
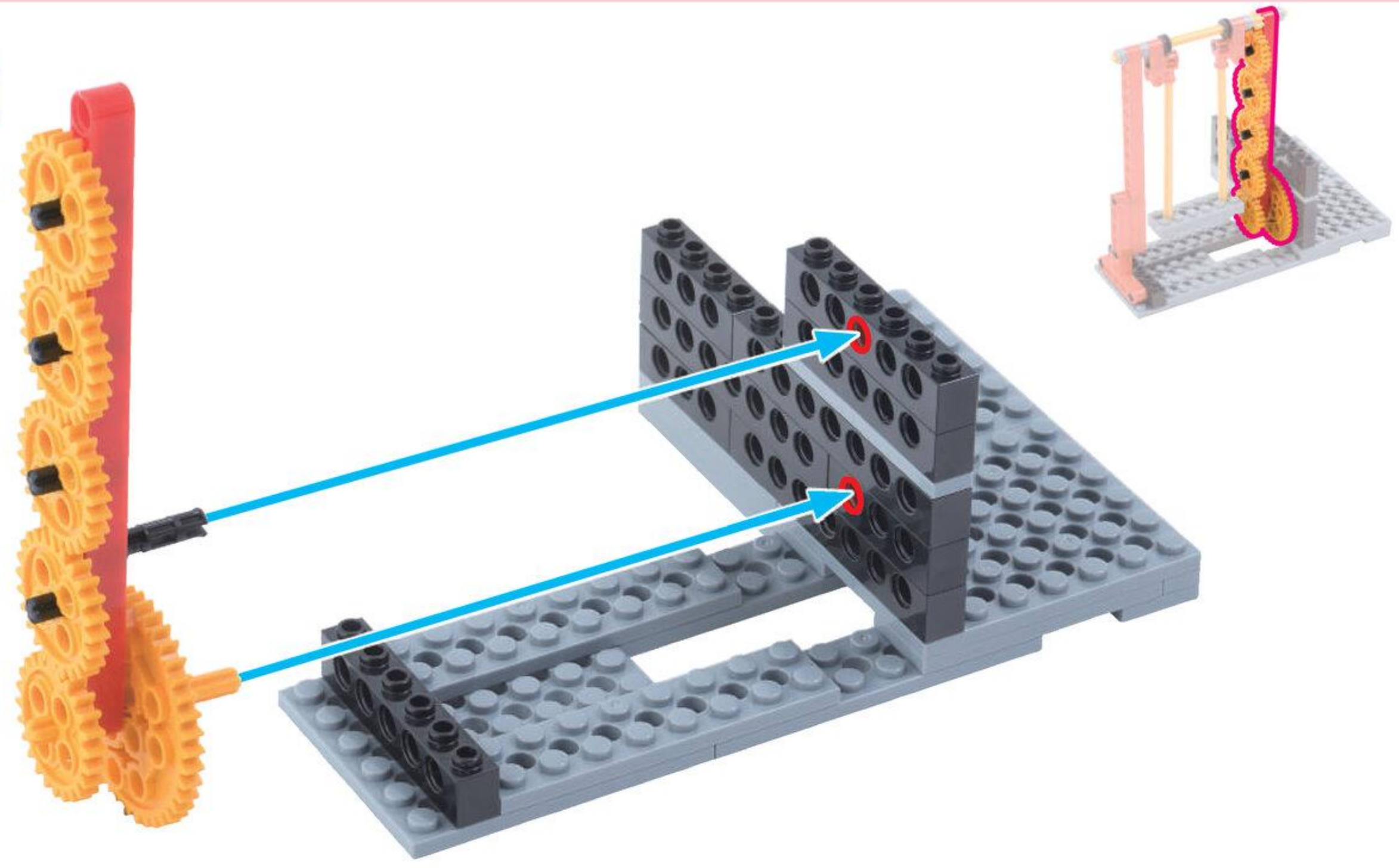

はしらが
かんせい!

やったね!

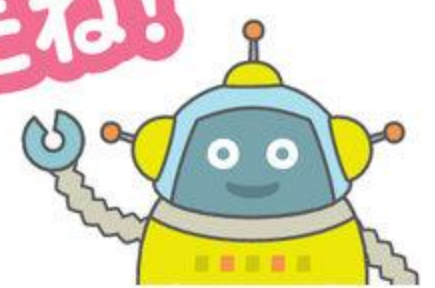

4

ぶらんこ
ブランコ

めやす 20 ぶん

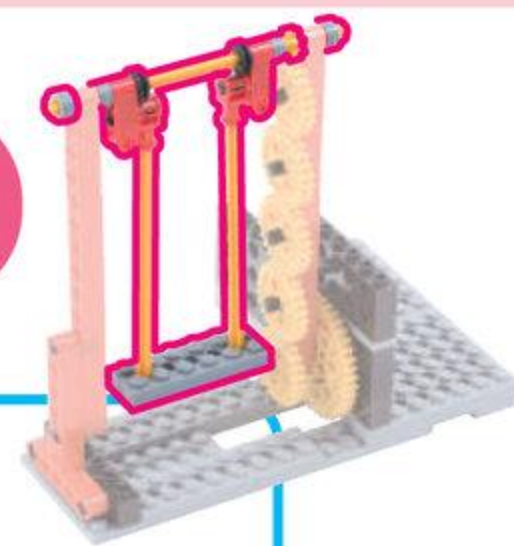

しゃふとじゅうにほち
シャフト 12 ポチ 2こ



ぶっしゅ
ブッシュ 2こ



1

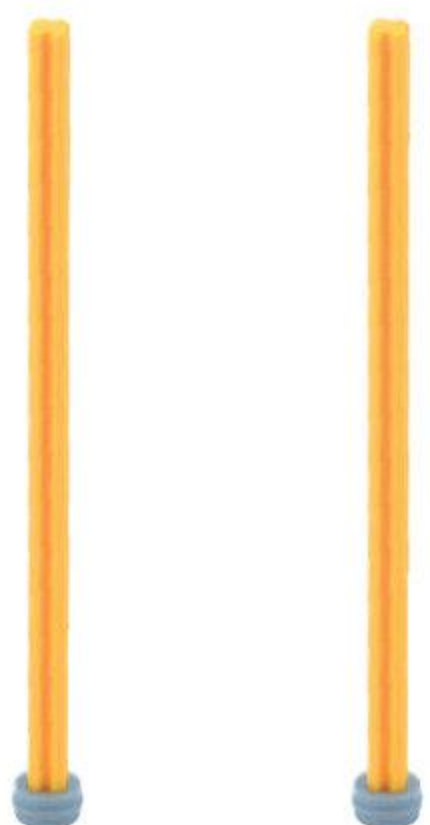
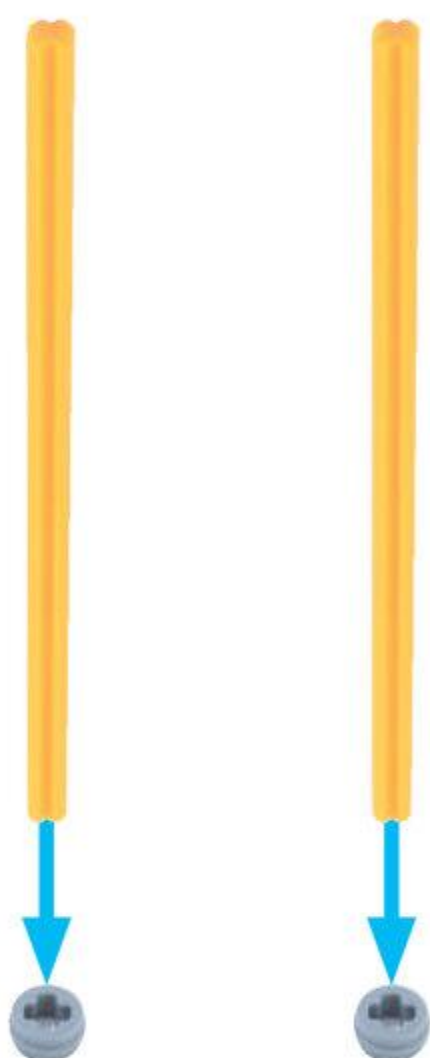

ふとぶれえとろくほち
太プレート6ポチ 2こ

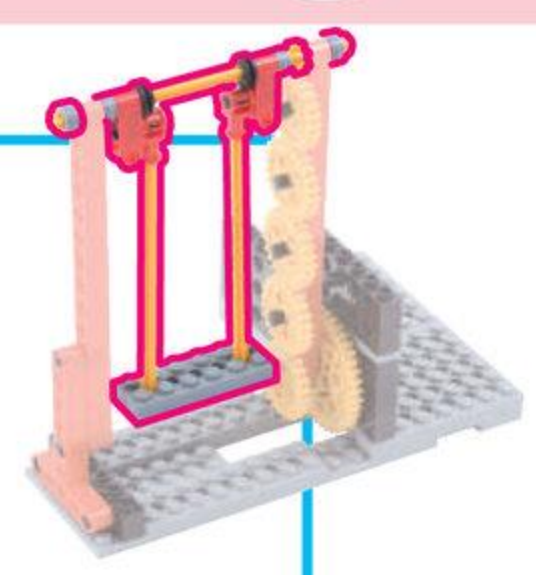

2

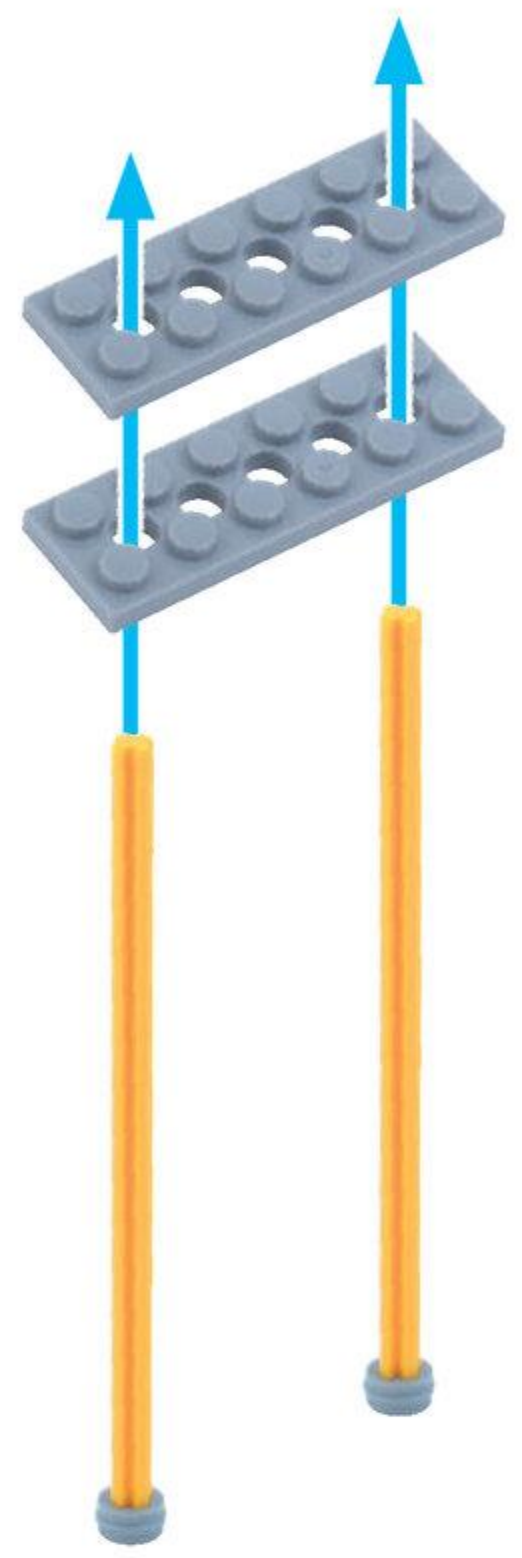

ていじょいんと
T ジョイント 2こ

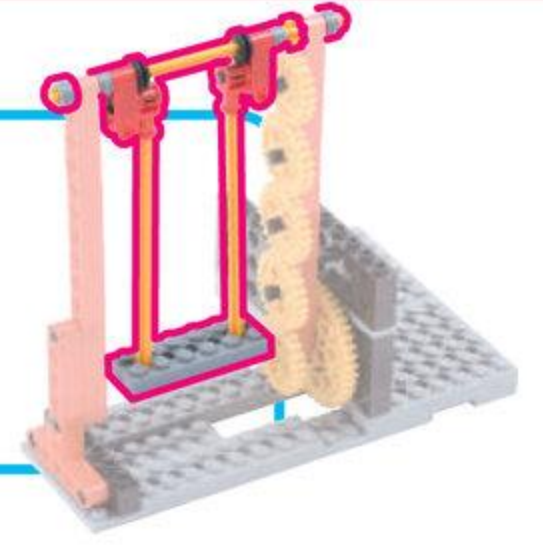

3

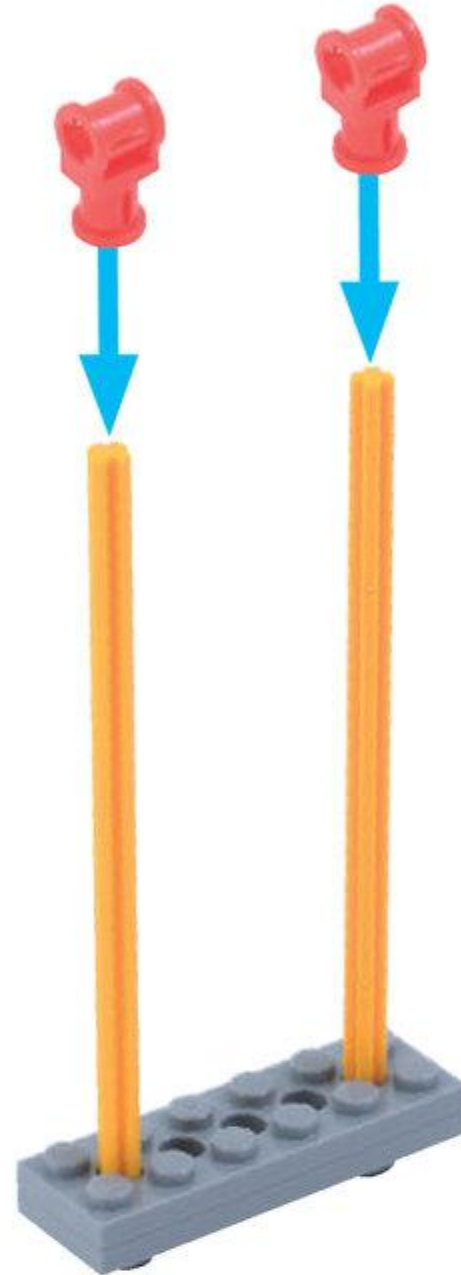

くろすじょいんと
クロスジョイント 2こ



しゃふとペグ
シャフトペグ 2こ

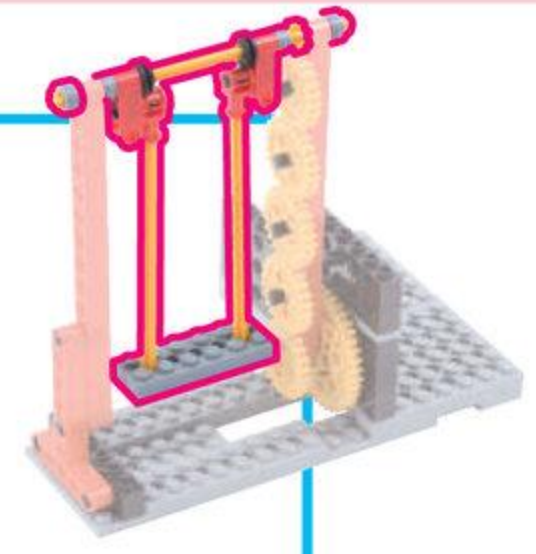
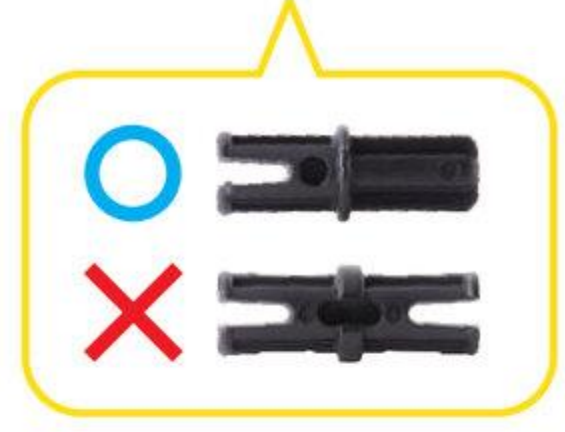

4



シャフト 12ポチ 1こ



グロメット 2こ

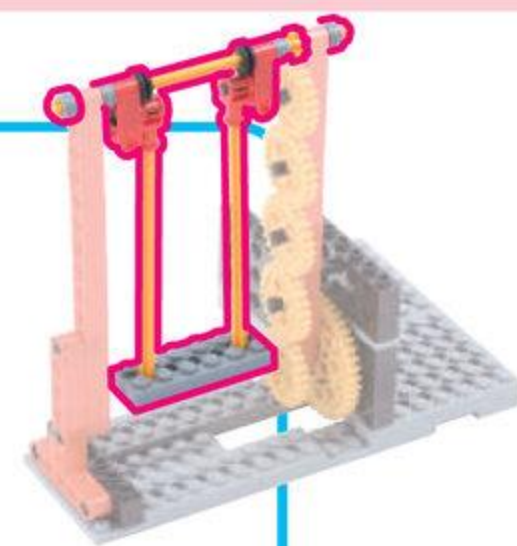

5



ぶっしゅ
ブッシュ 2こ



びにおんぎあ
ピニオンギアうす 1こ

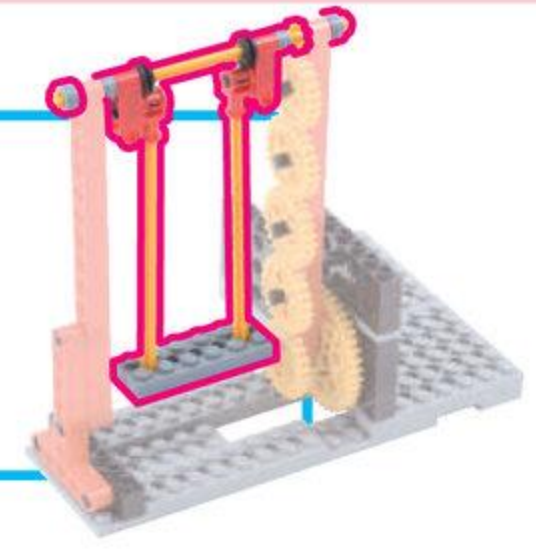

6

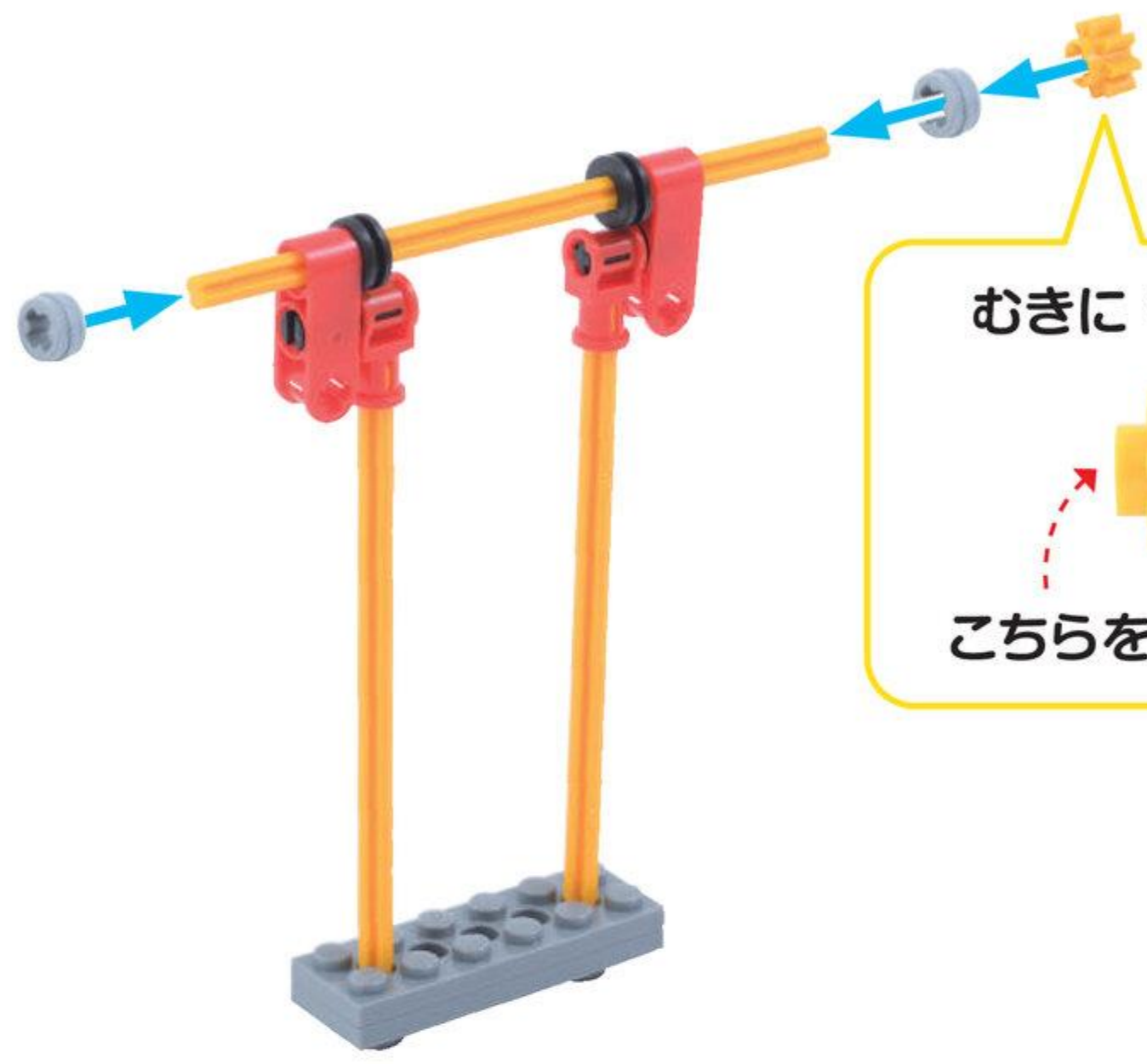

むきに ちゅうい
こちらを さしこむ



ぶっしゅ 1こ

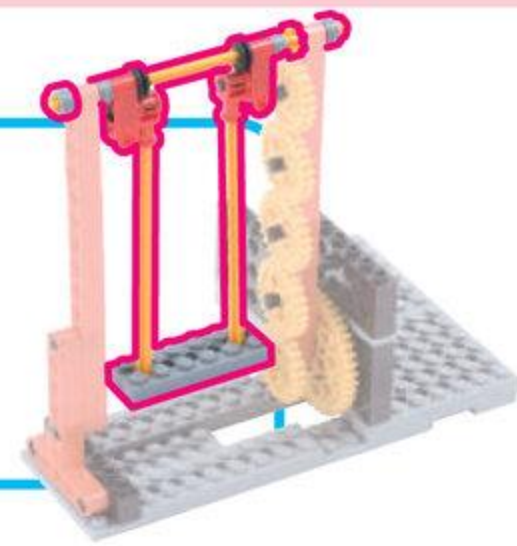

7

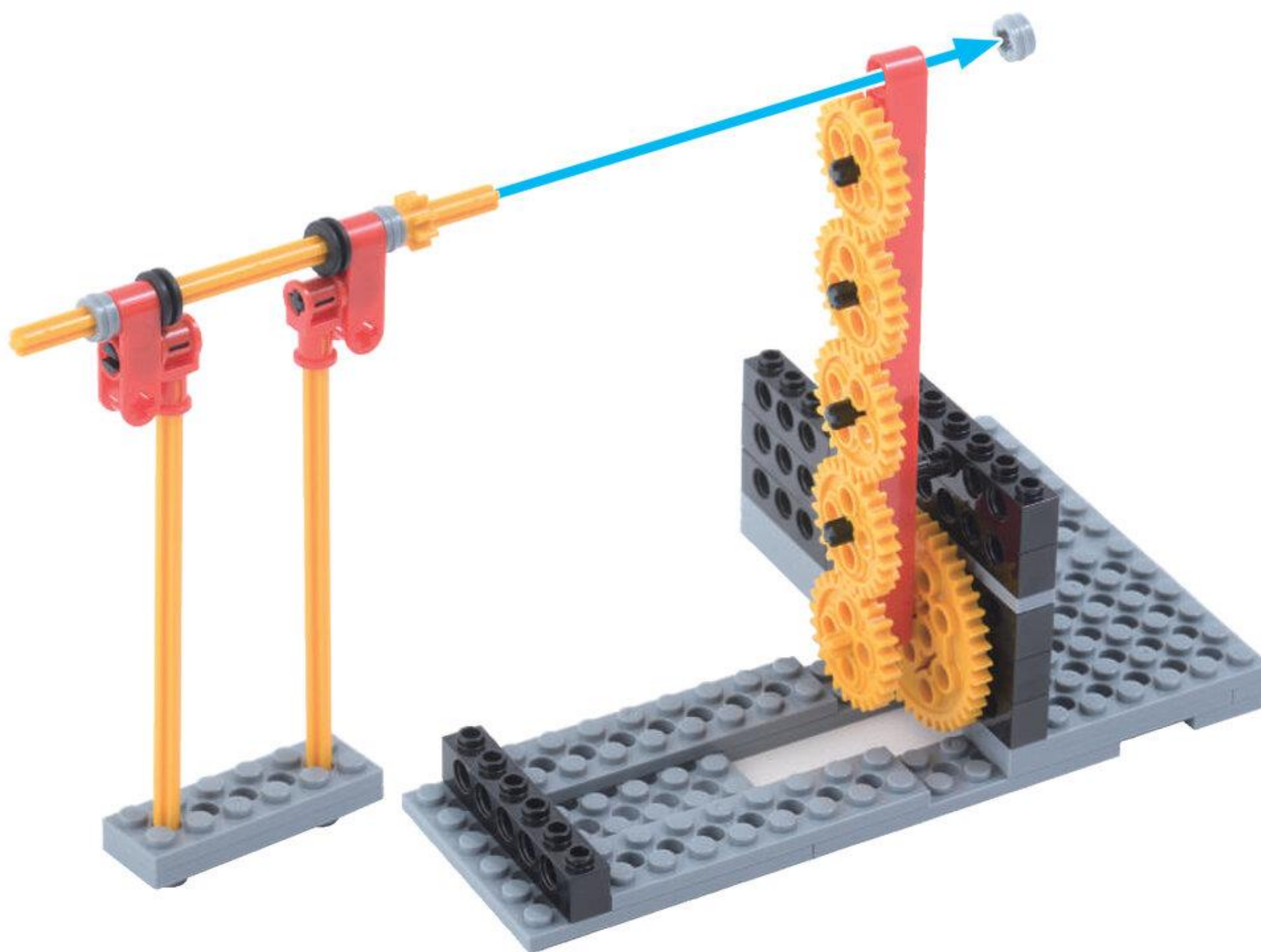

しっかり かみあわせよう



ぶらんこ
ブランコが
かんせい!

やったね!

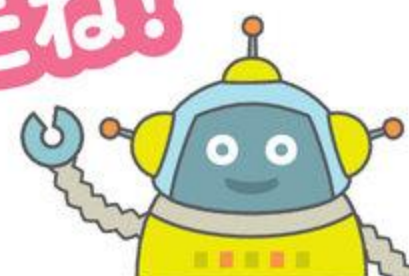

5 もう1つのはしら めやす 5 ぶん

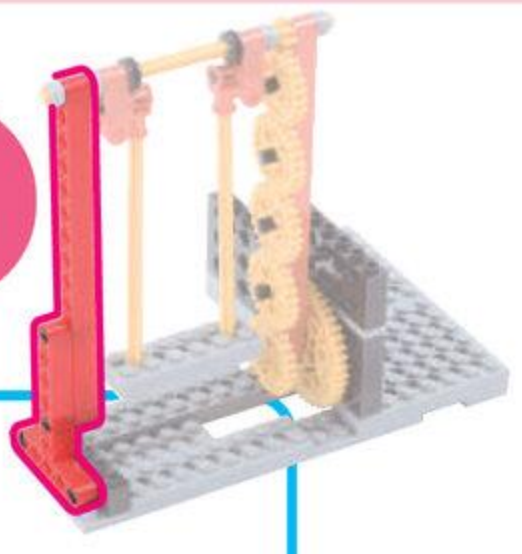

てい るっど T ロッド 1こ

ぺぐ えす S 4こ

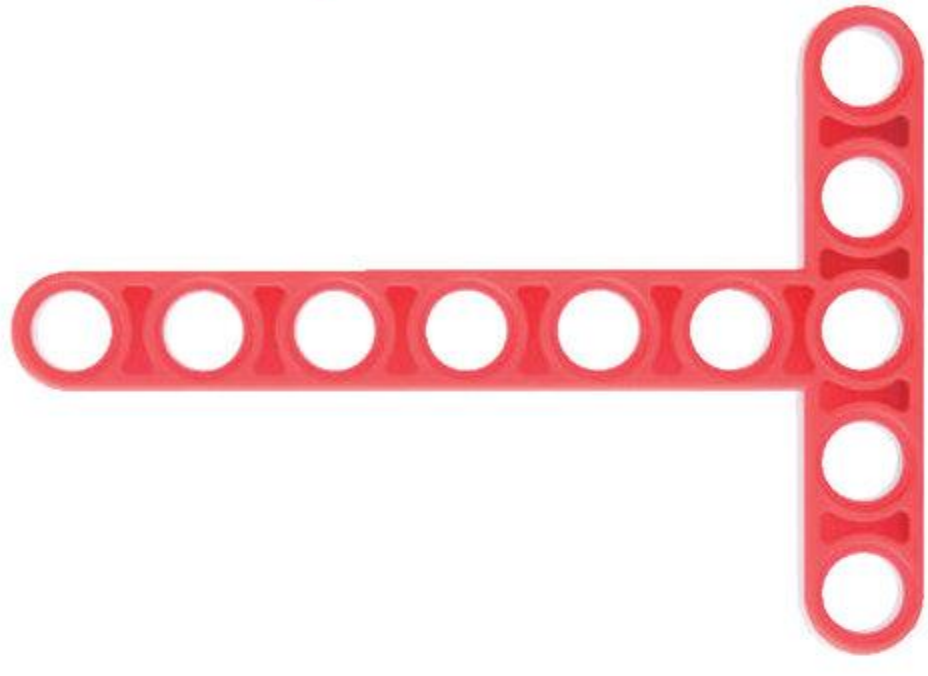

1

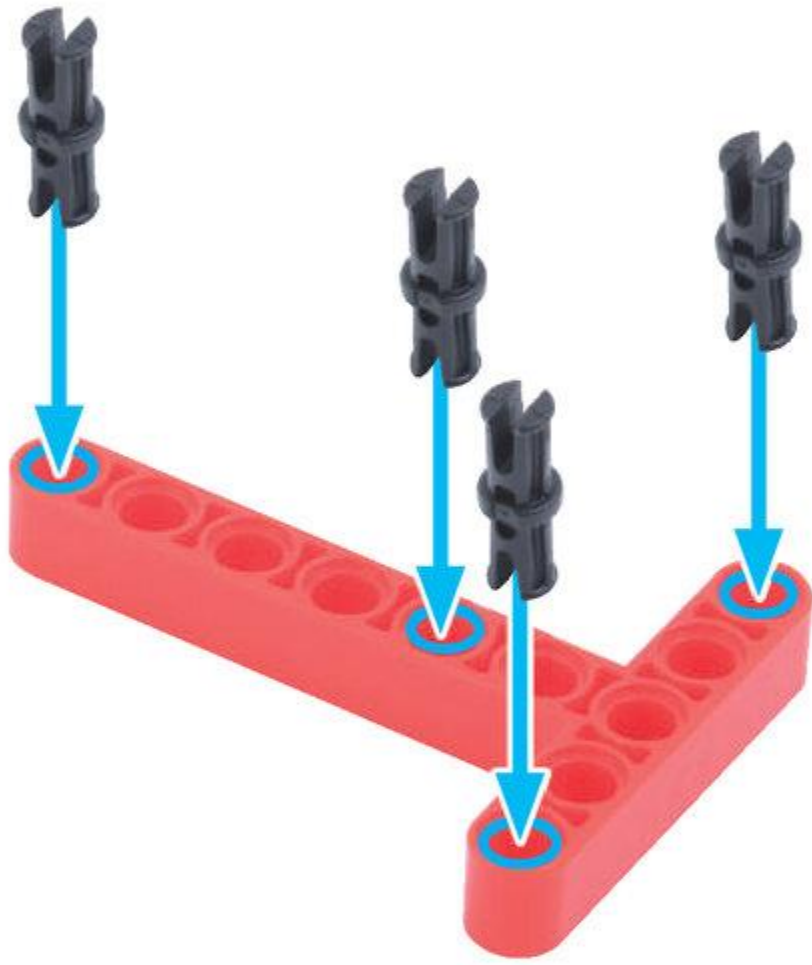

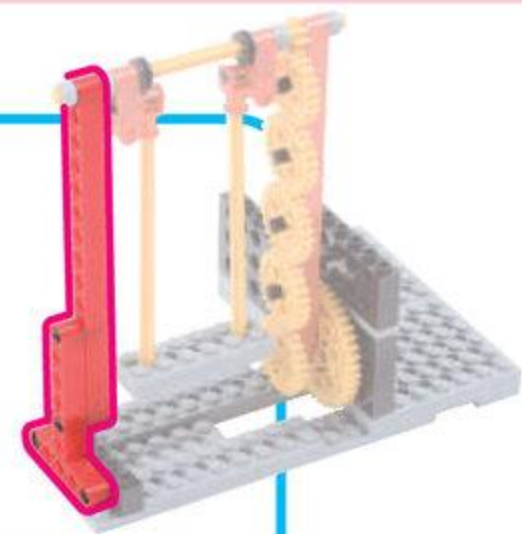

ろっど 15 アナ 1こ



2

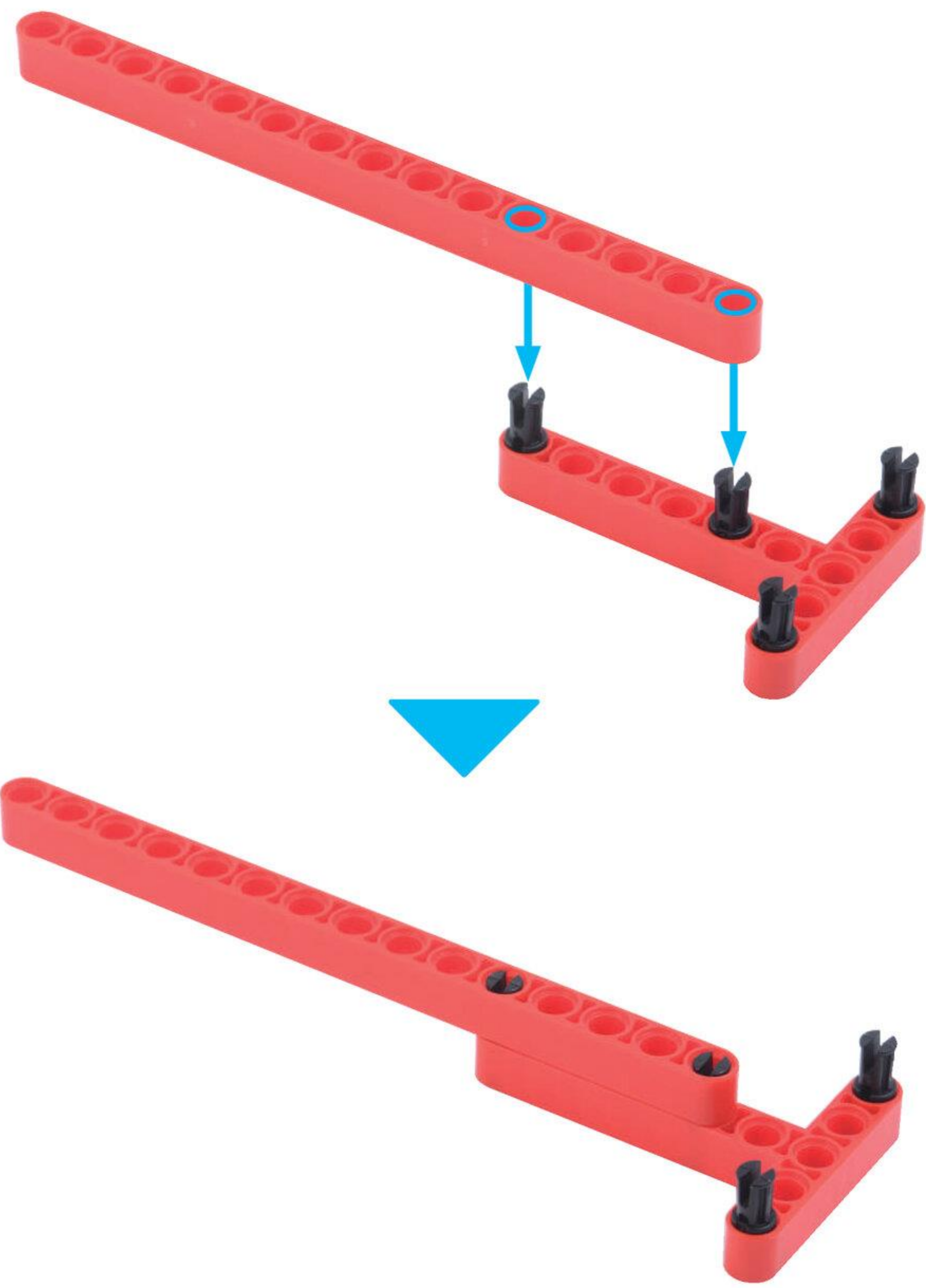

ぶっしゅ
ブッシュ 1こ

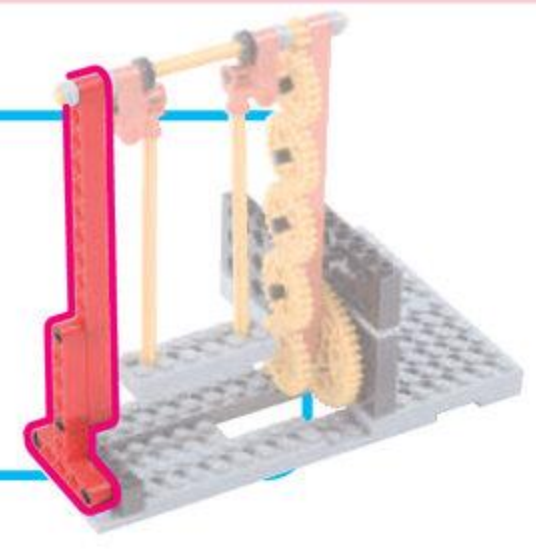

3

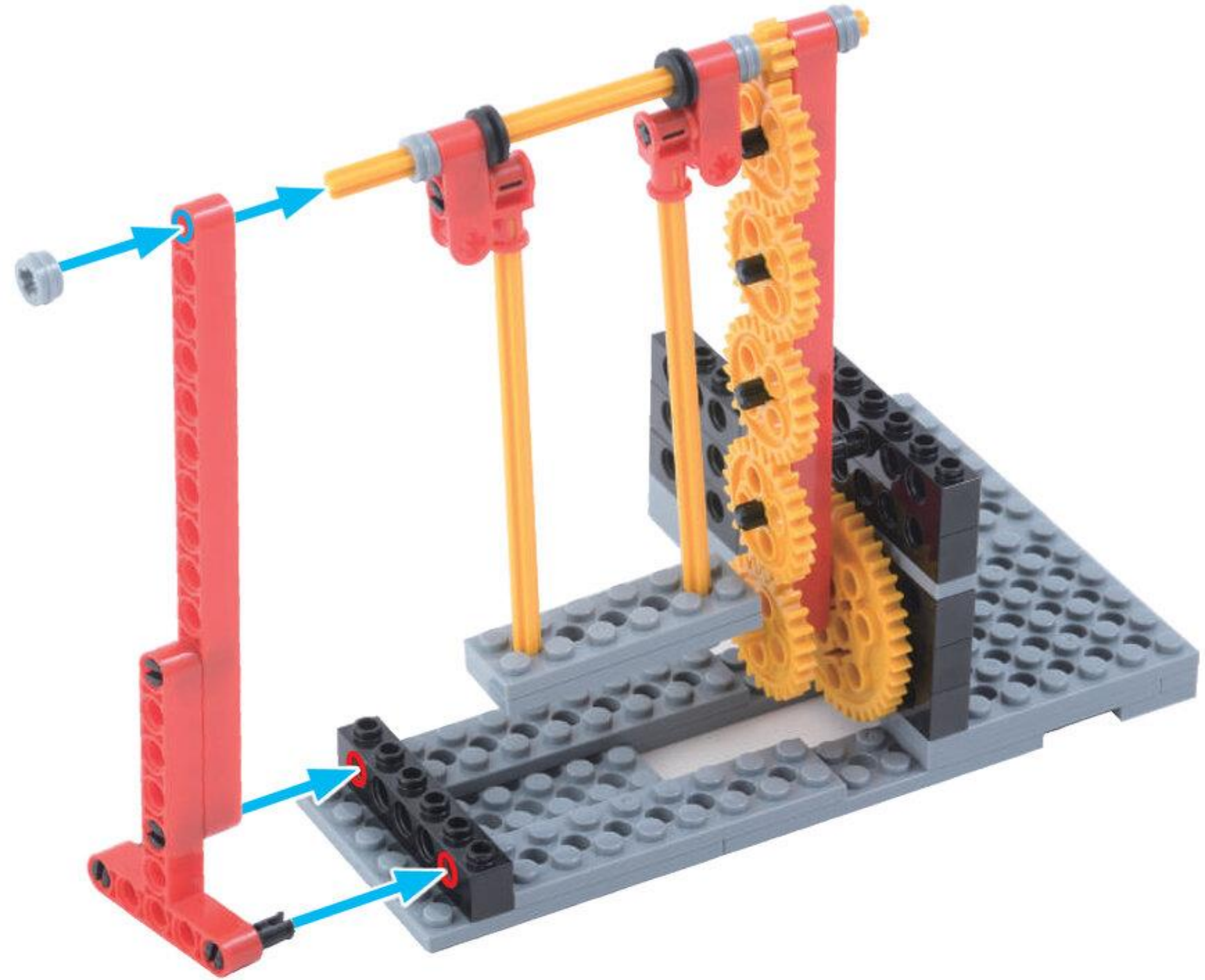

これで
かんせい!

よくできました!

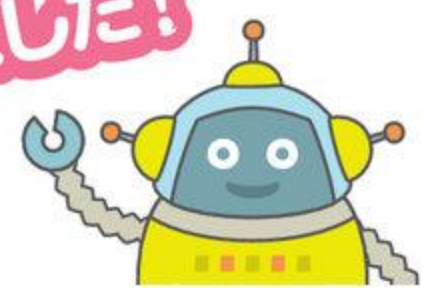

ロボットをうごかさそう

めやす 10 ぶん

くらんく 1こ



1

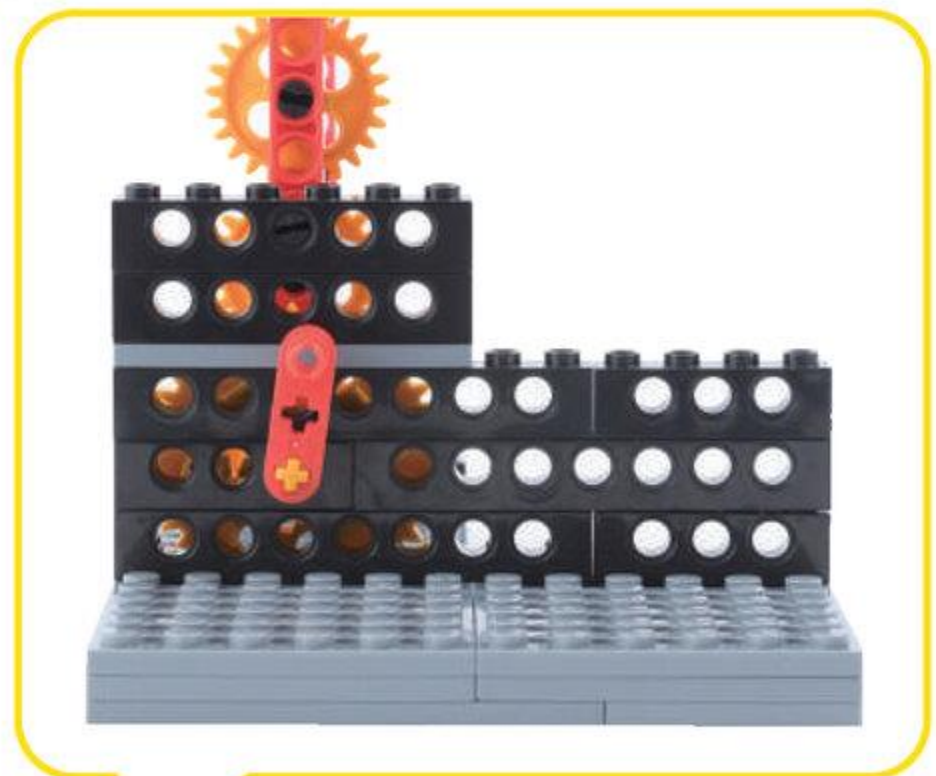
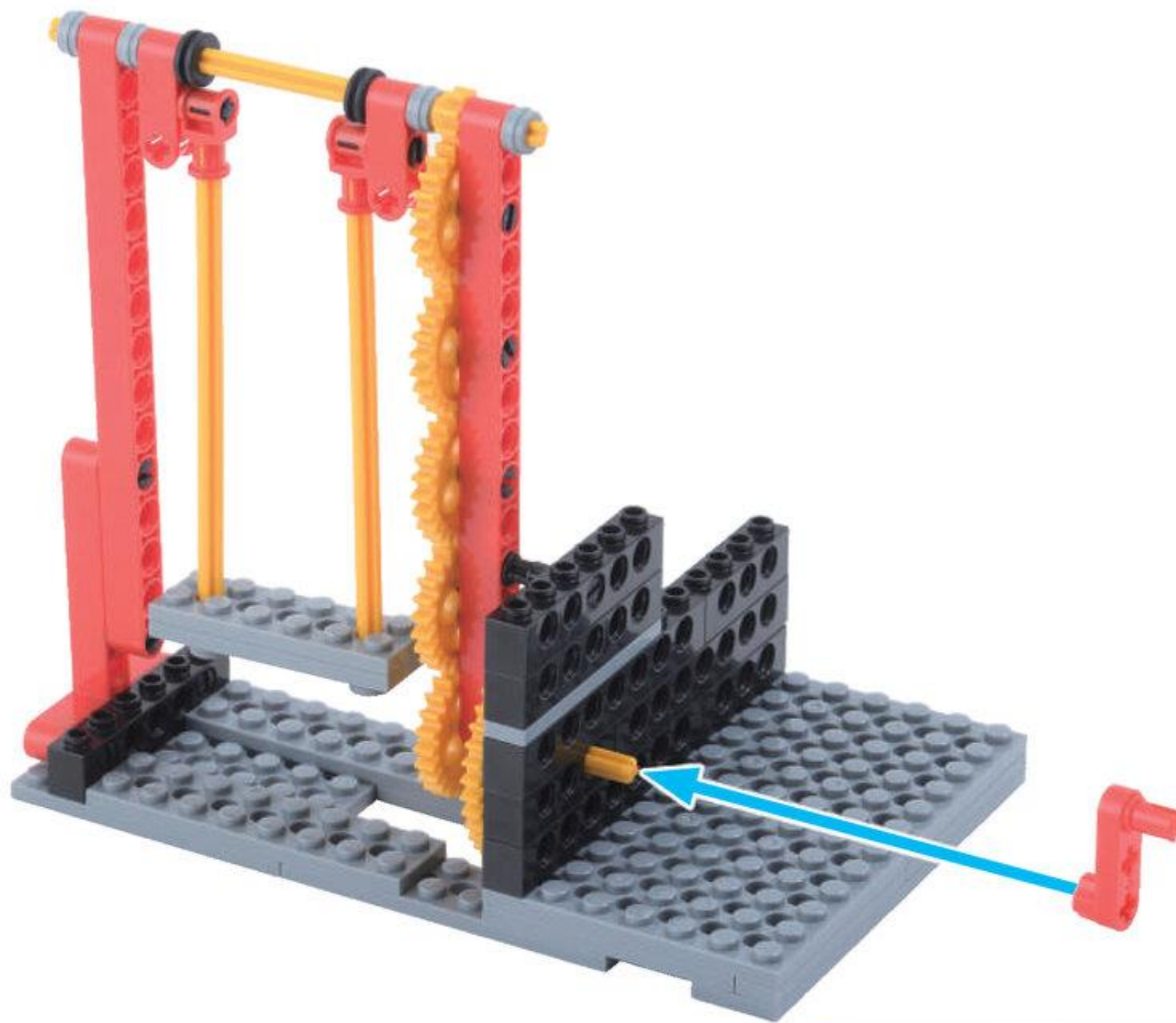

ぶらんこ
ブランコを てで
ささえながら
ばいりつと
パイロットを
のせよう

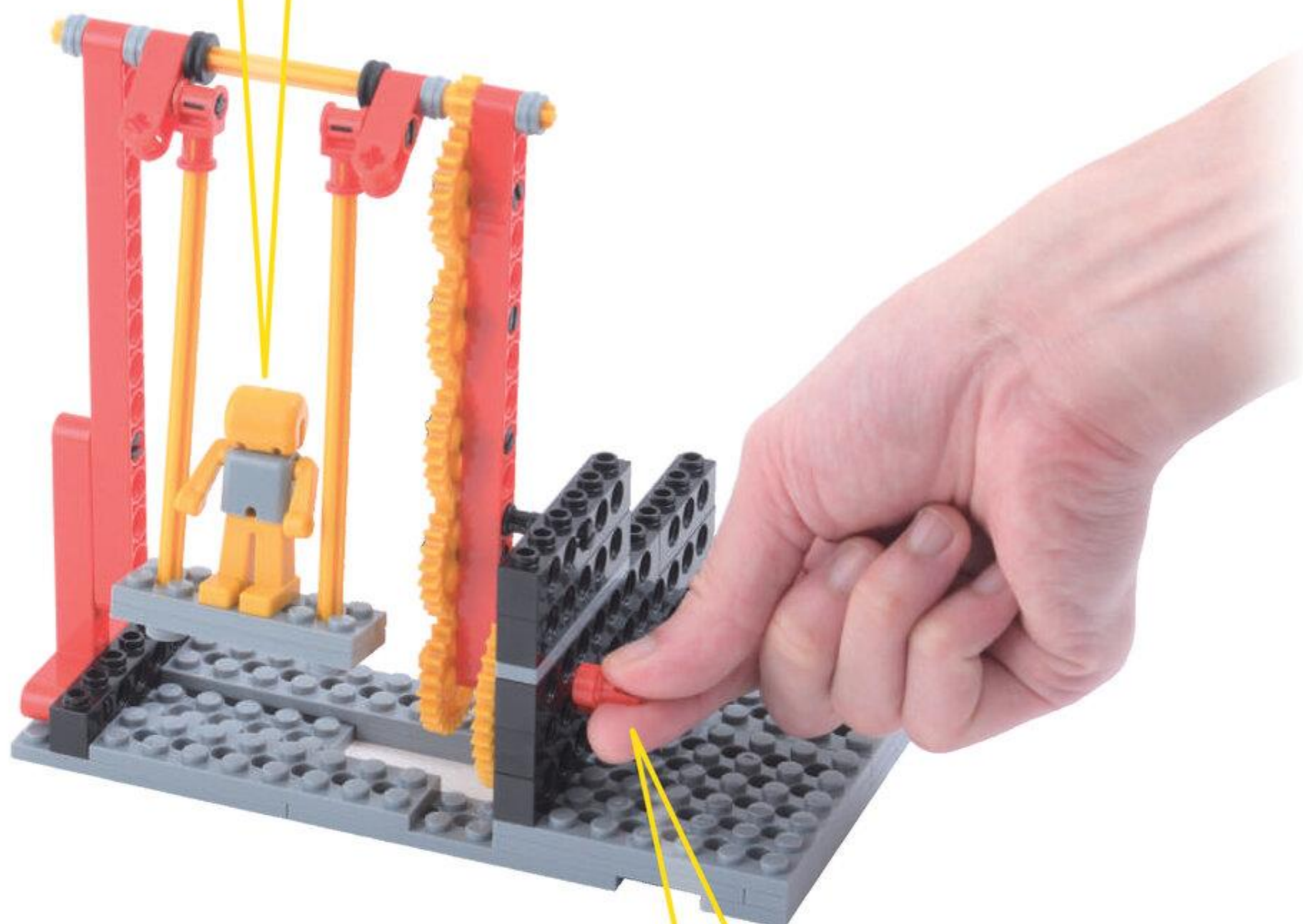

やじるしの ように
くらんく
クランクを うごかそう

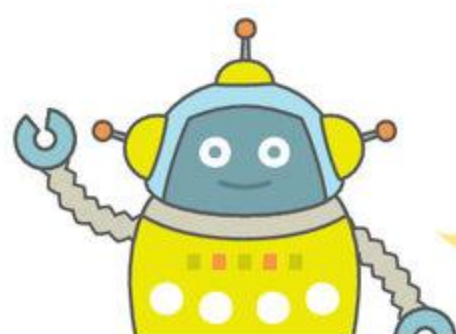
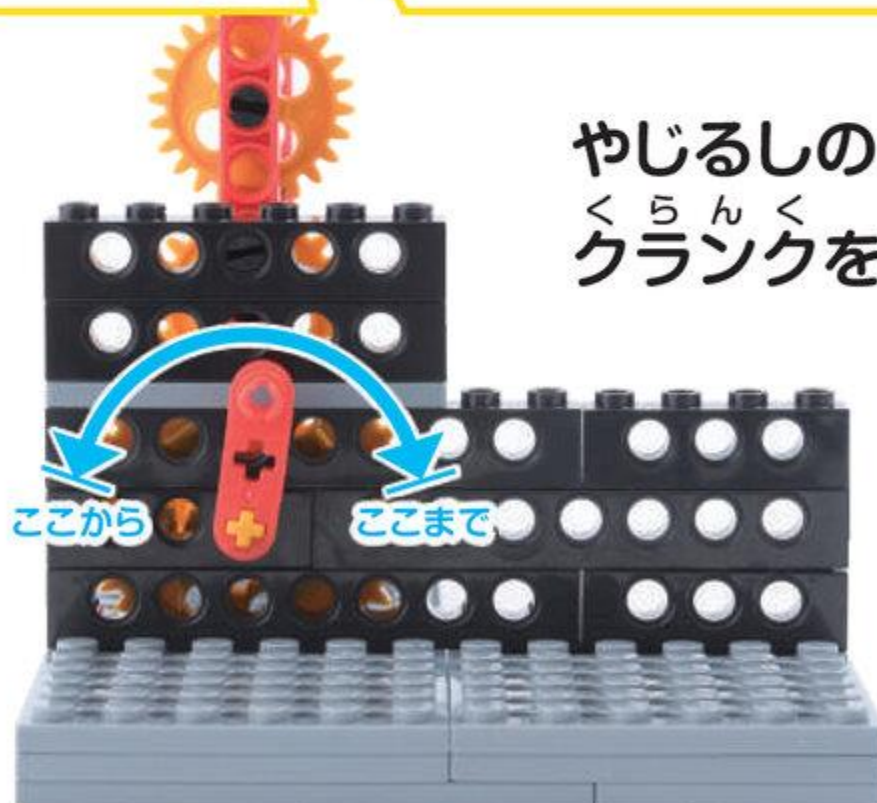

じかいは ^{も お た あ} モーターで うごくように
かいぞう してい くよ

Q1 ^{てい}T ^{じょいんと}ジョイントをさがそう! どれかな? 

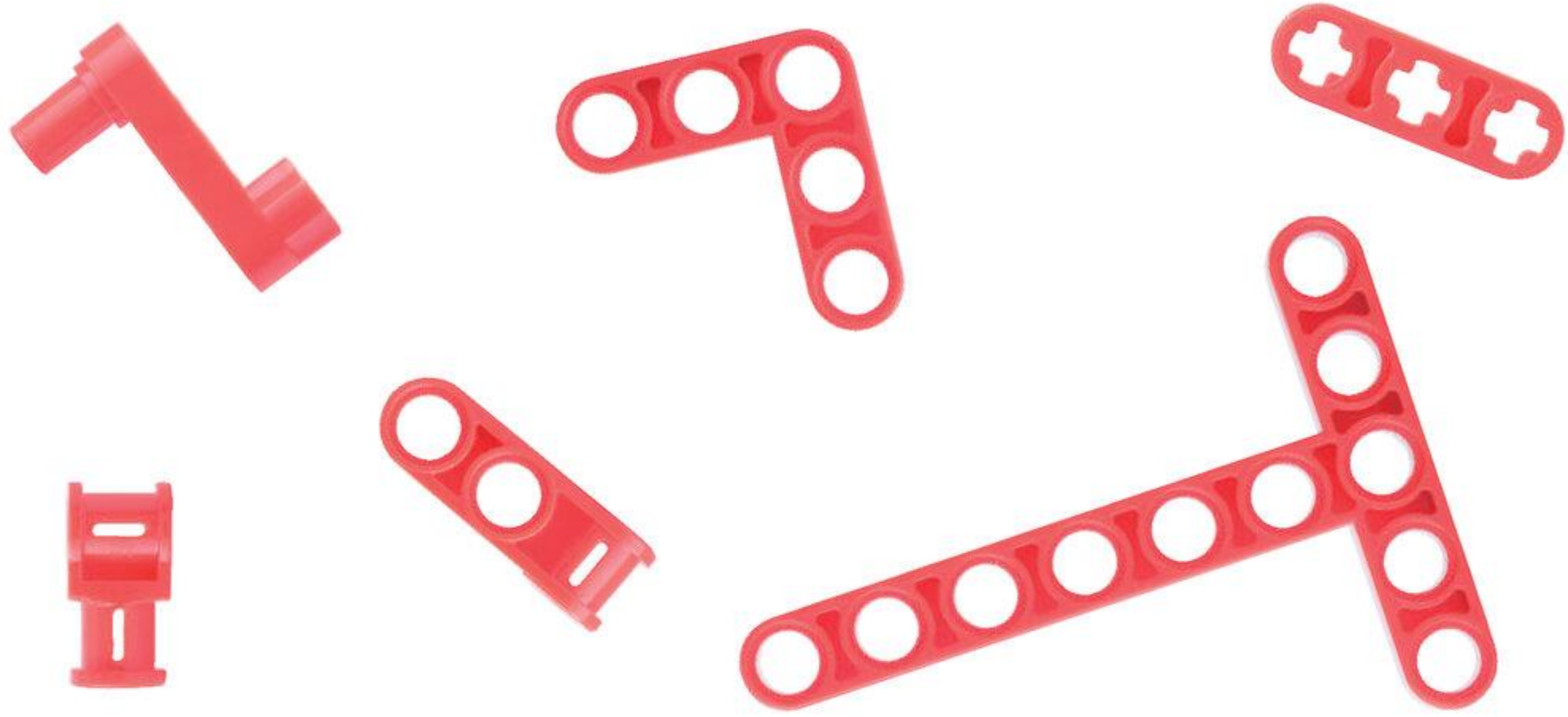

Q2 ^{くろす}クロスジョイントには ^{ペグ}ペグ ^{えす}S をなんことりつけられるかな?



ペグ ^{えす}S

(1 こ ・ 2 こ ・ 3 こ) 

Q3 ^{くろす}クロスジョイントには ^{シャフト}シャフト ^{ペグ}ペグ をなんことりつけられるかな?



シャフト ^{ペグ}ペグ

(1 こ ・ 2 こ ・ 3 こ) 



Human

ヒューマンアカデミー ジュニア
STEAMスクール



ロボット教室

ロボットのきょうかしよ

プレプライマリーコース 回

2

ぶらんこロボ「ゆらりん」



★だい2かい

2022 ねん

11 がつ

にち

なまえ

きょうの よてい

めやす 2 ふん

このじゅんばんでつくるよ!

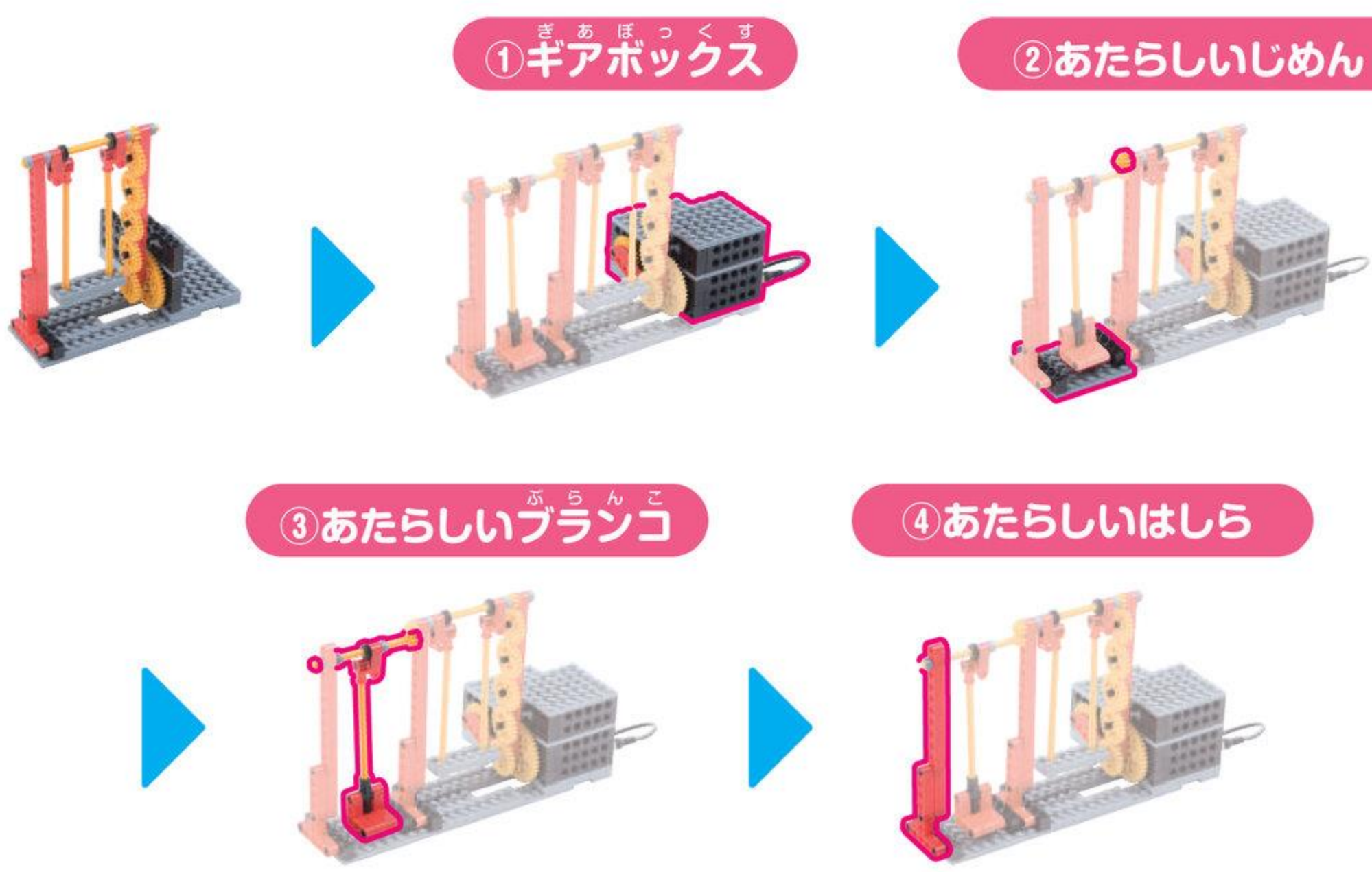
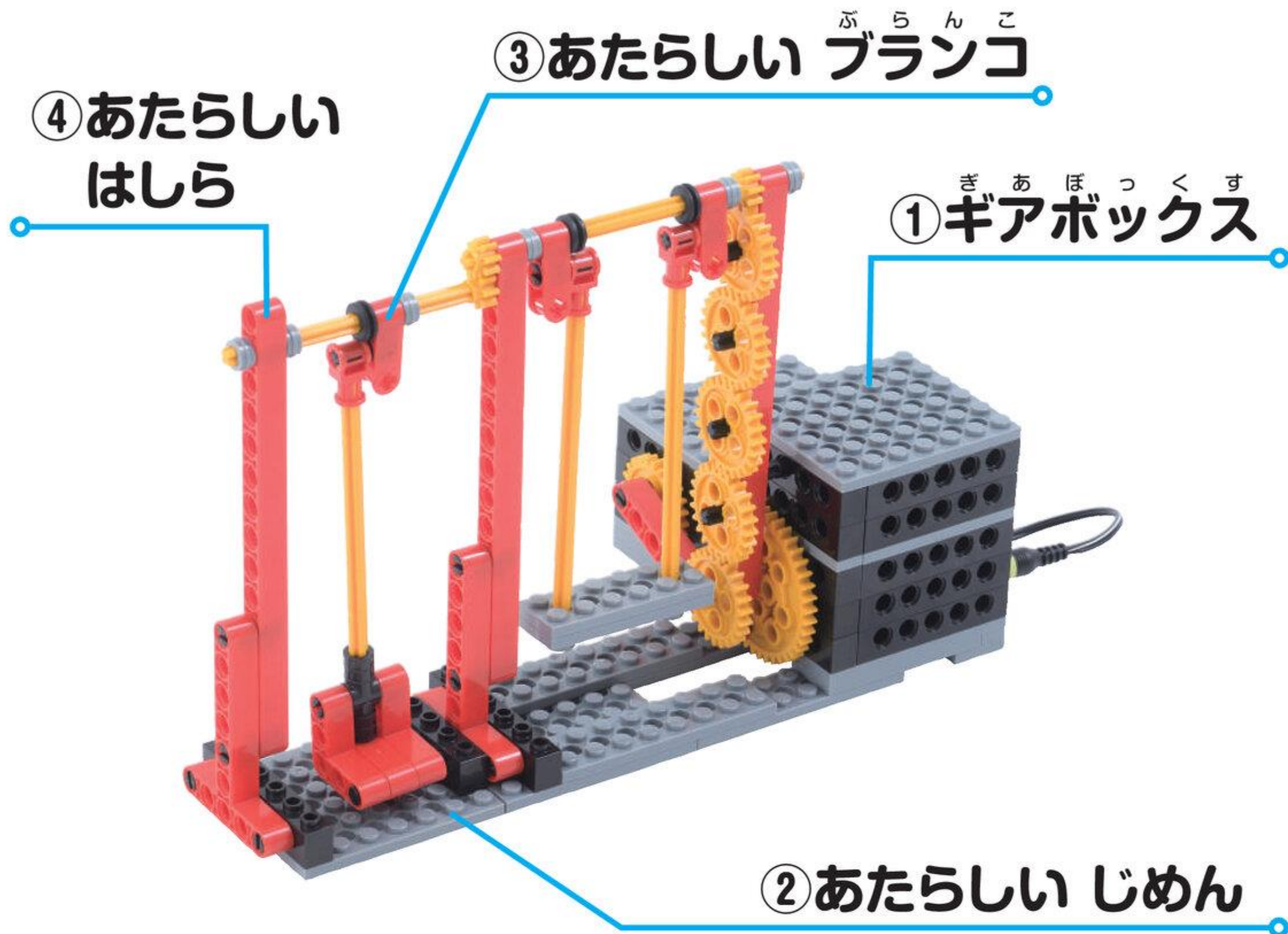

1 ぎあほっくす ギアボックス

めやす 25 ぶん

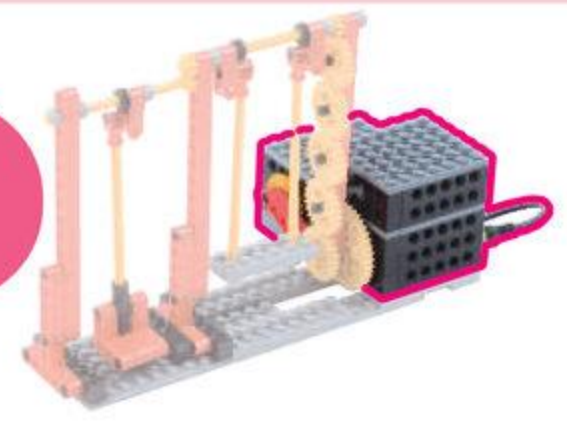

1

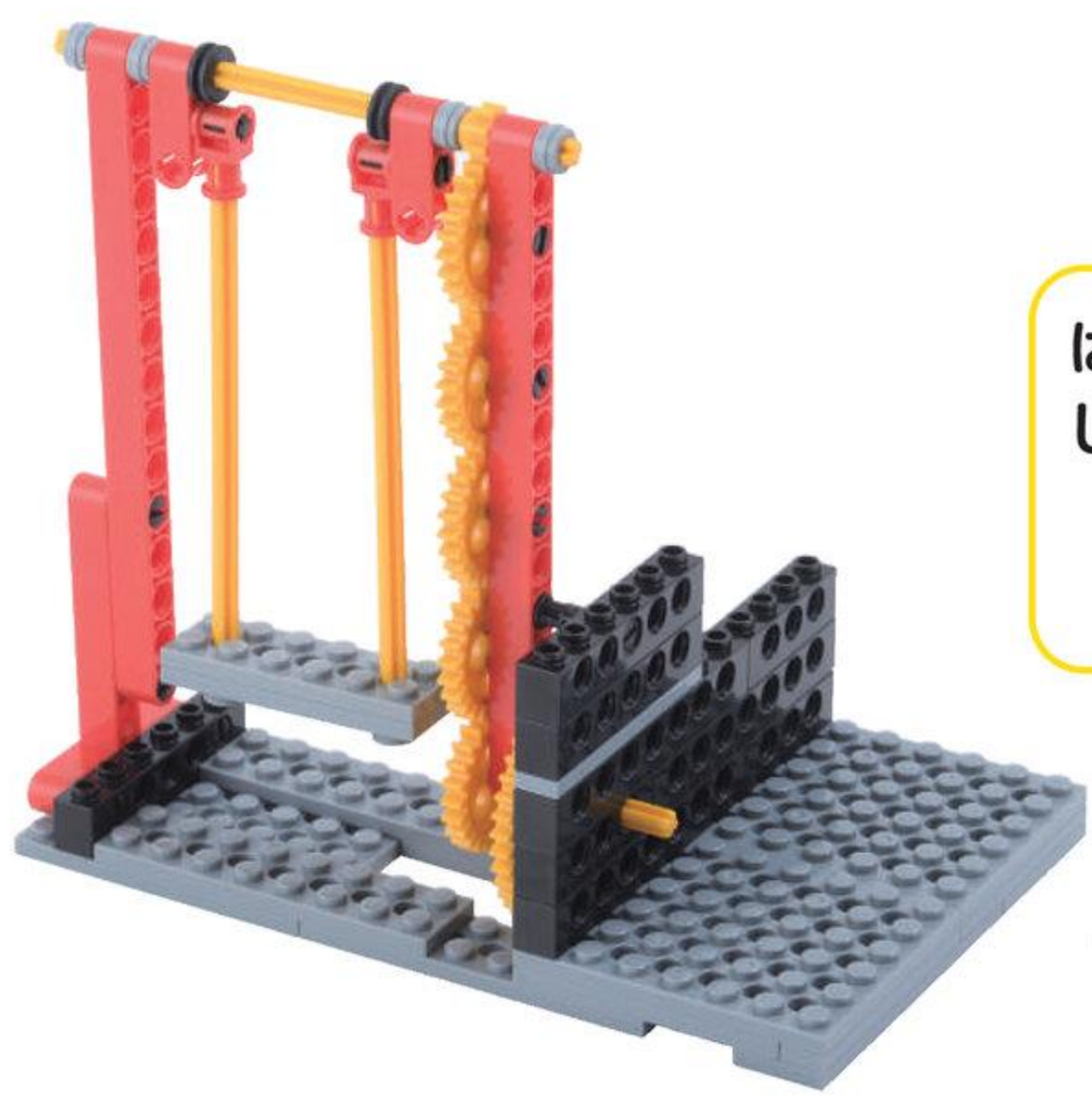
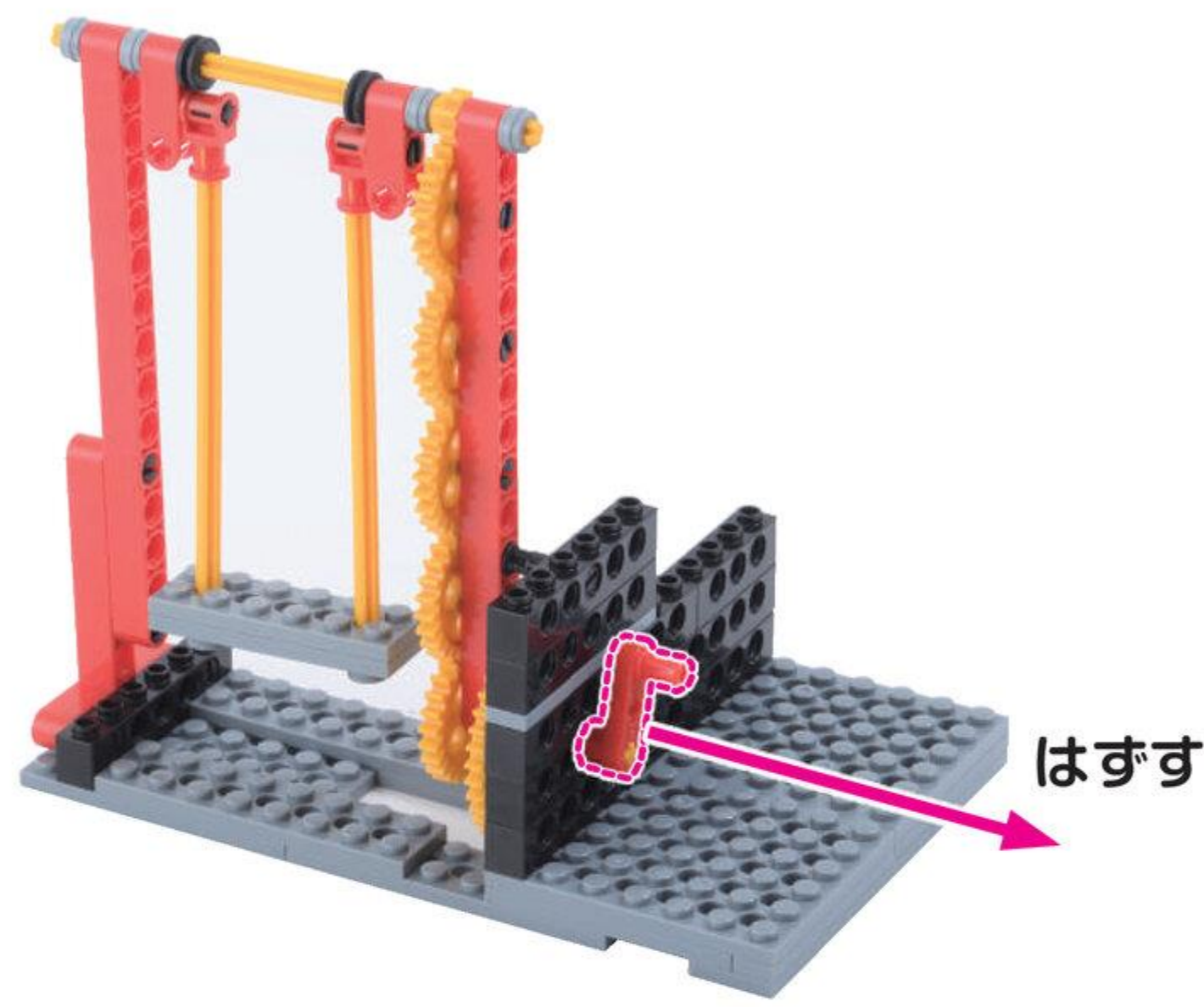

はずした ぼあっ パーツは
しまおう

2

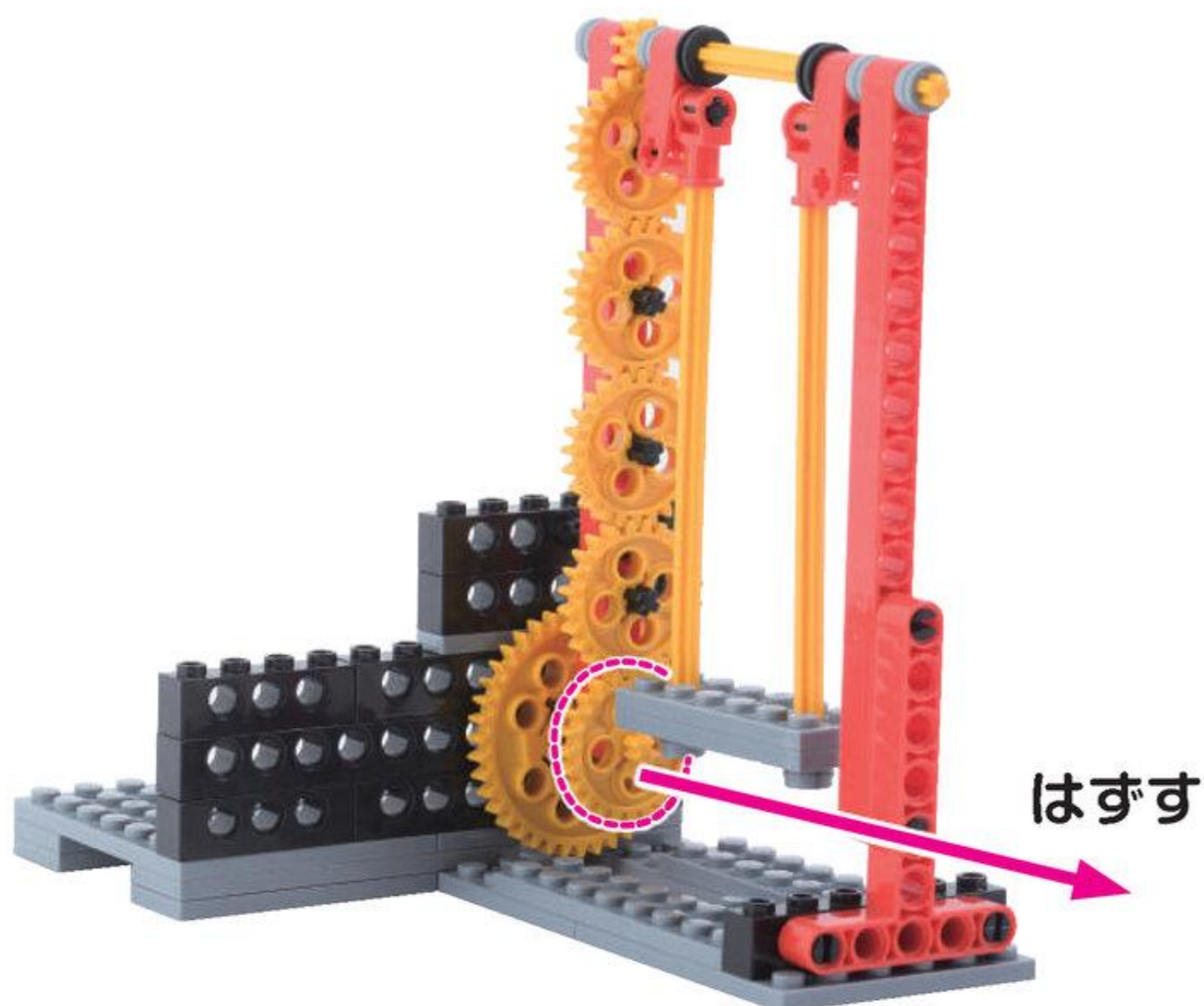
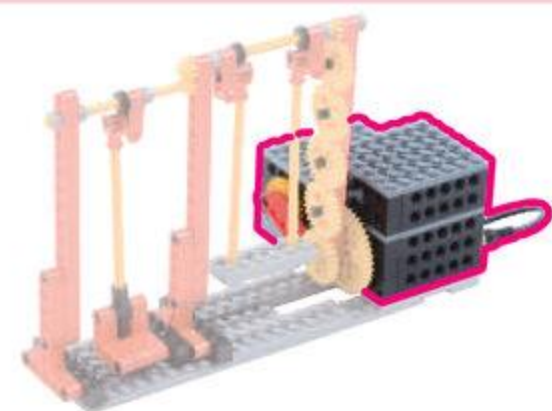

ぎあえむ
ギア M 1こ

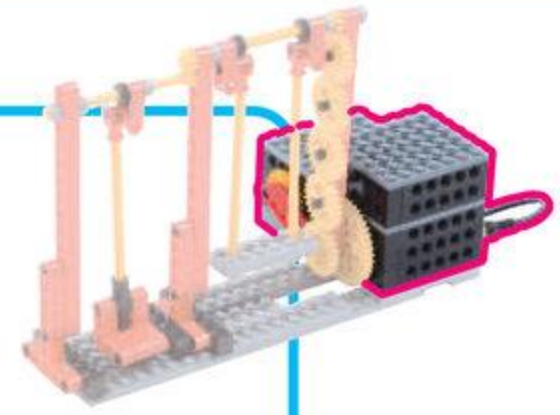
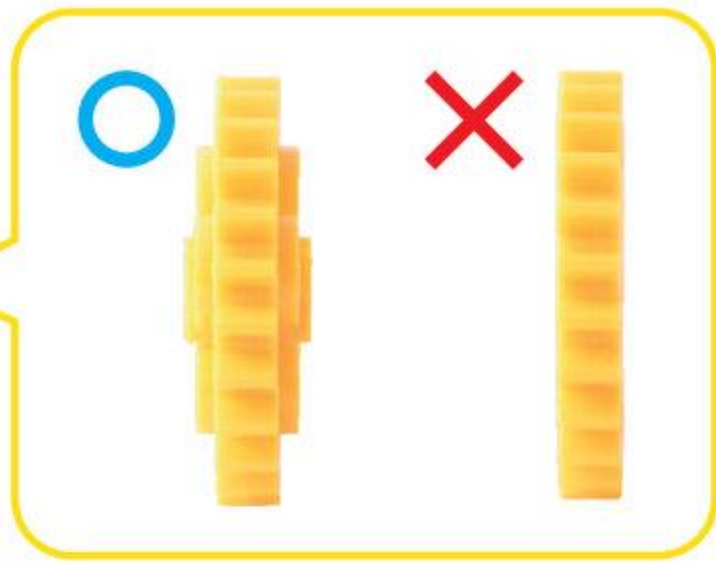

しゃふとさんほち
シャフト 3ポチ 1こ



ながさに
ちゅうい

3

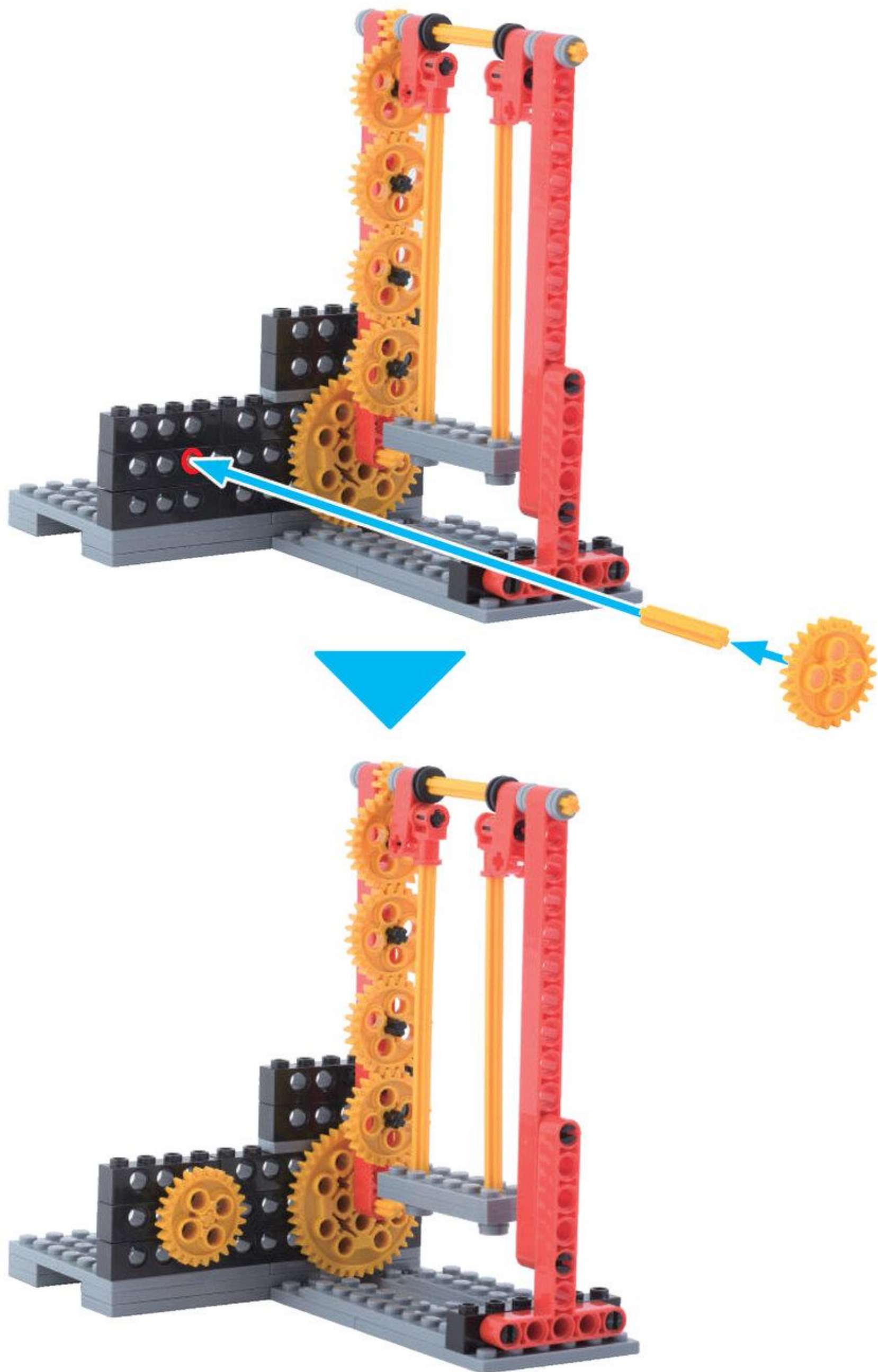

へぐえす
ペグS2こ

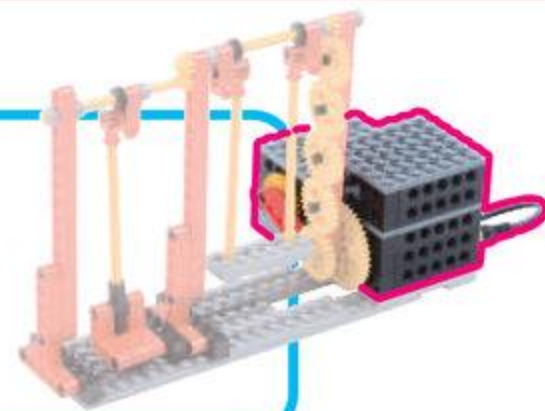

4

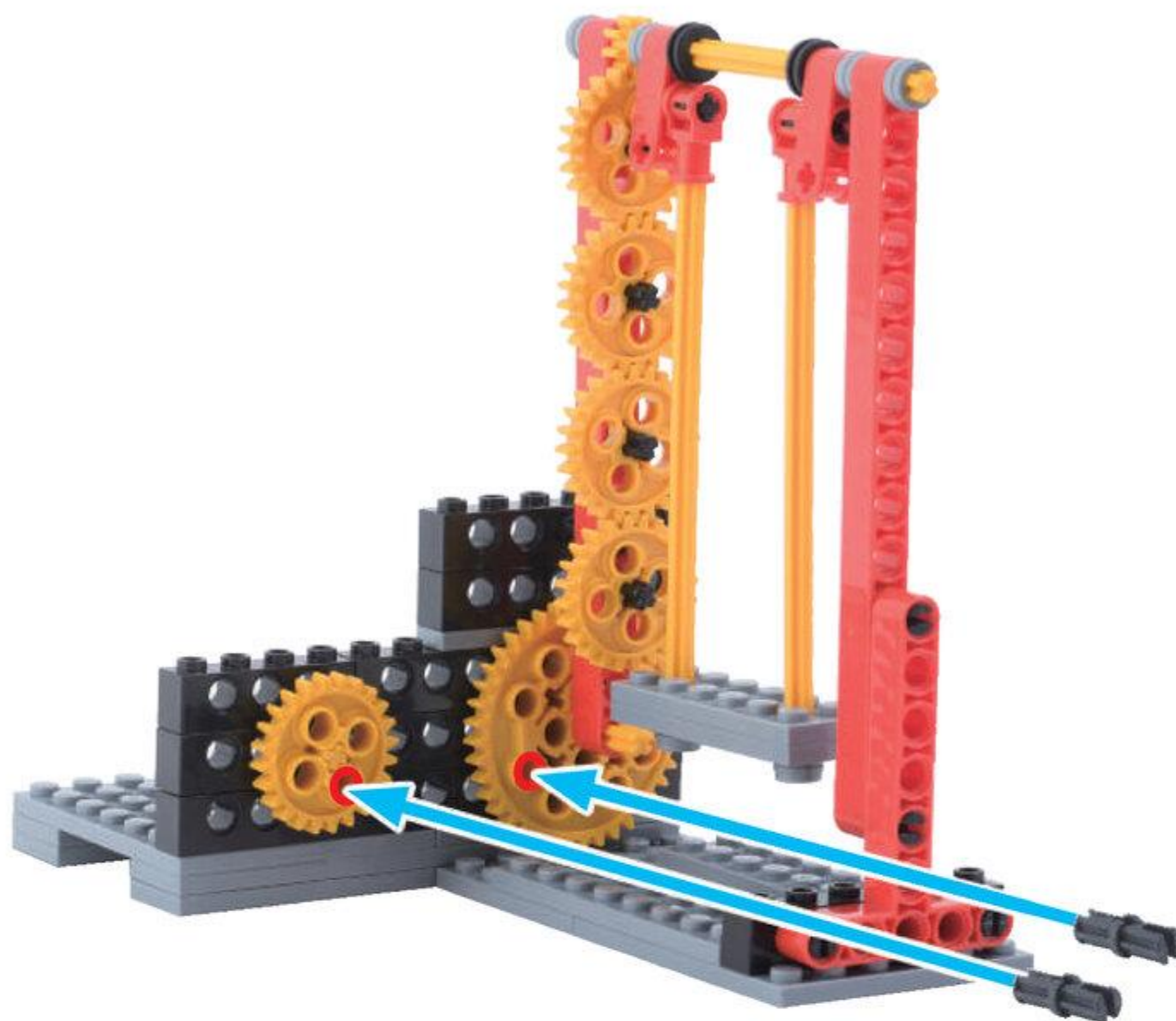

ろっどなあな 1こ
ロッド7アナ

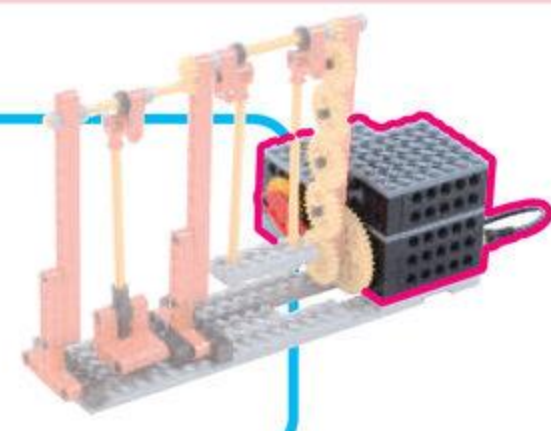

5

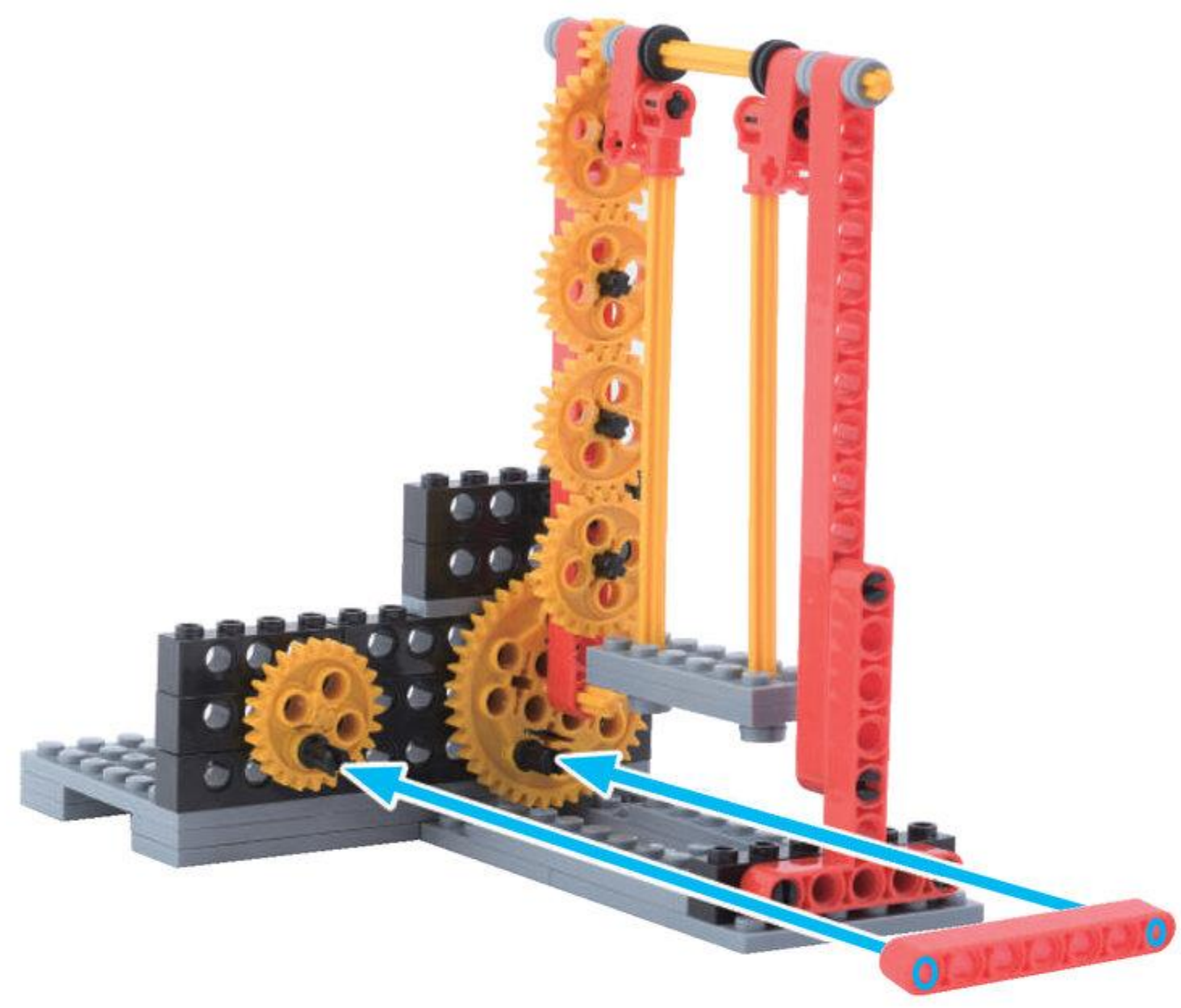

ぎあえむ
ギア M を うごかして
さしこめる いちを さがそう



ぎあえむ
ギア M うす 1 こ

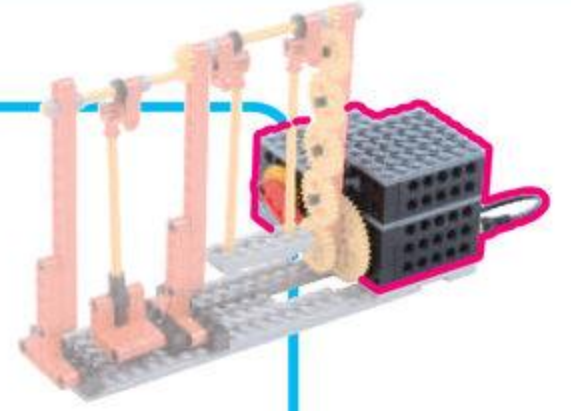
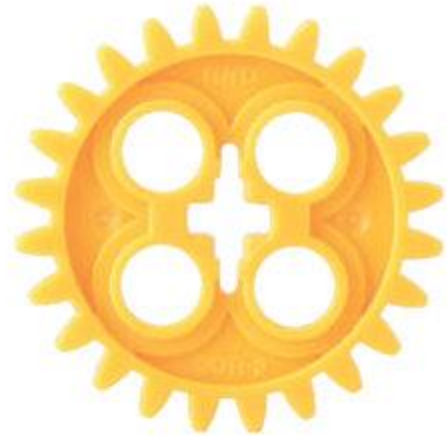

6

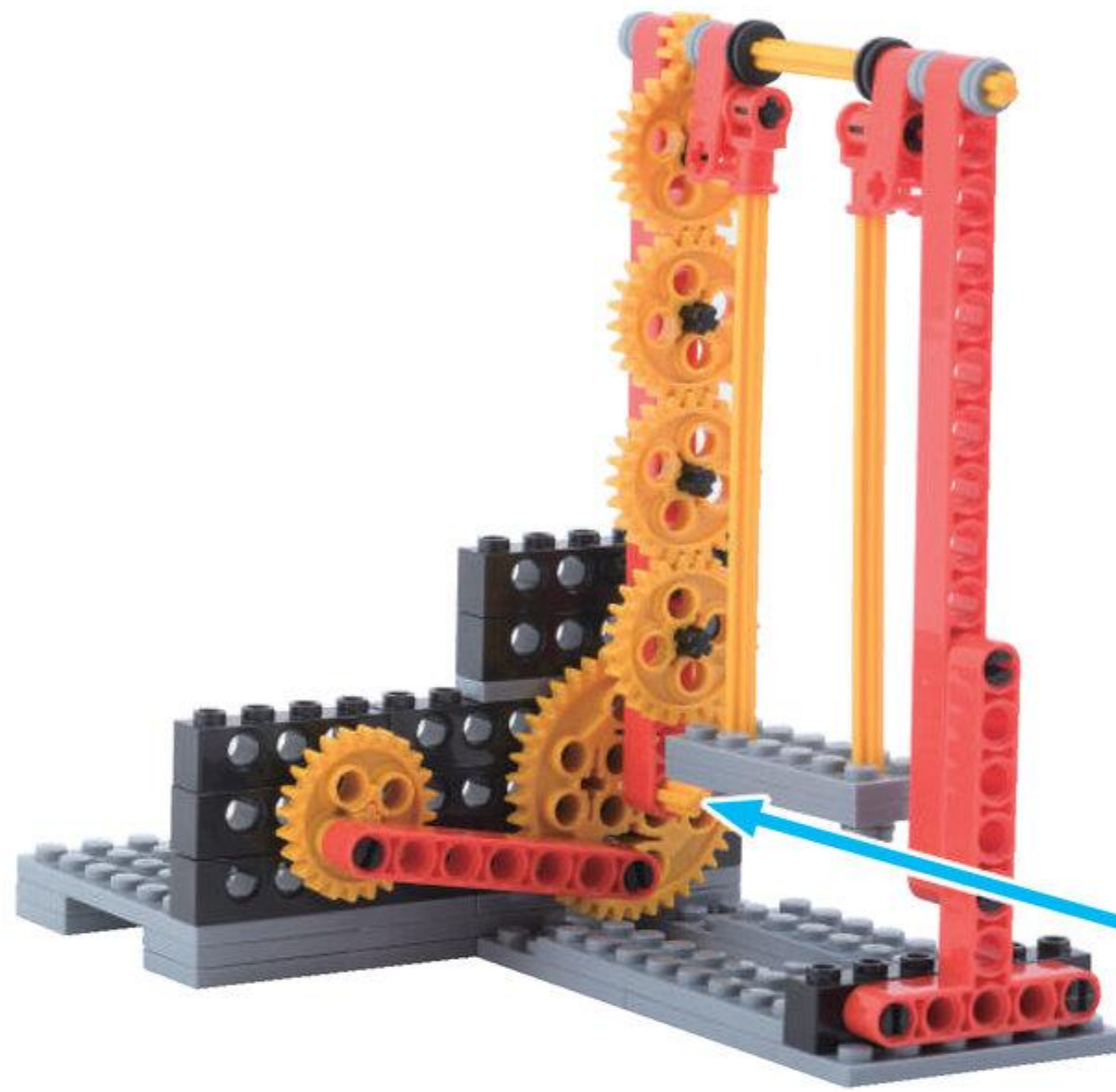

もどすよ

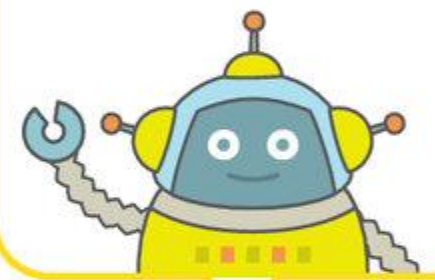

ギア M 1こ

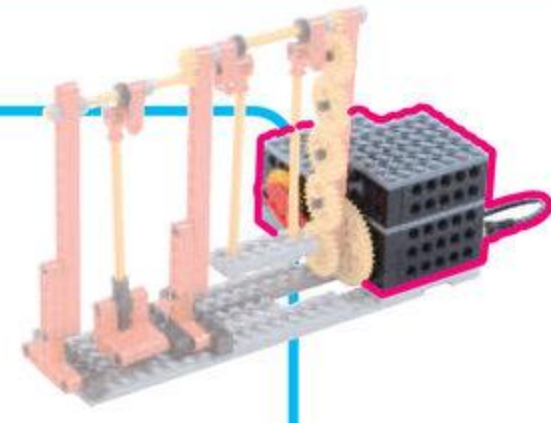
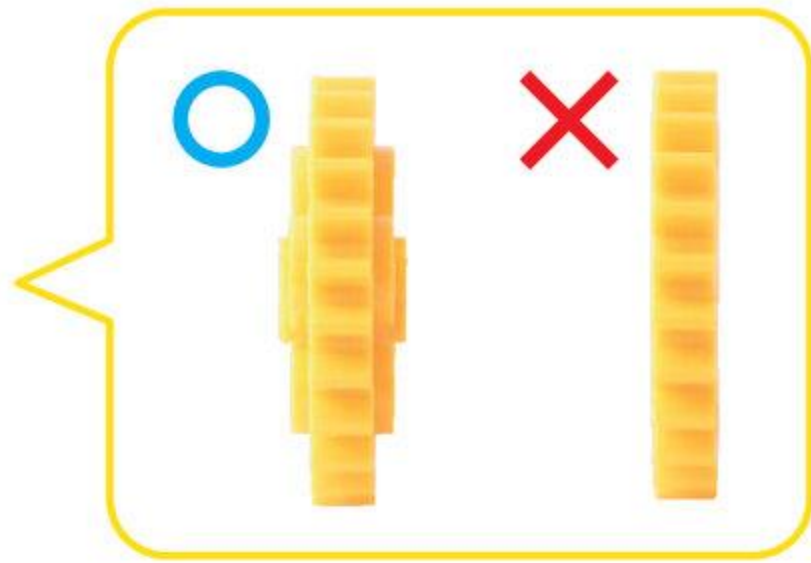

7

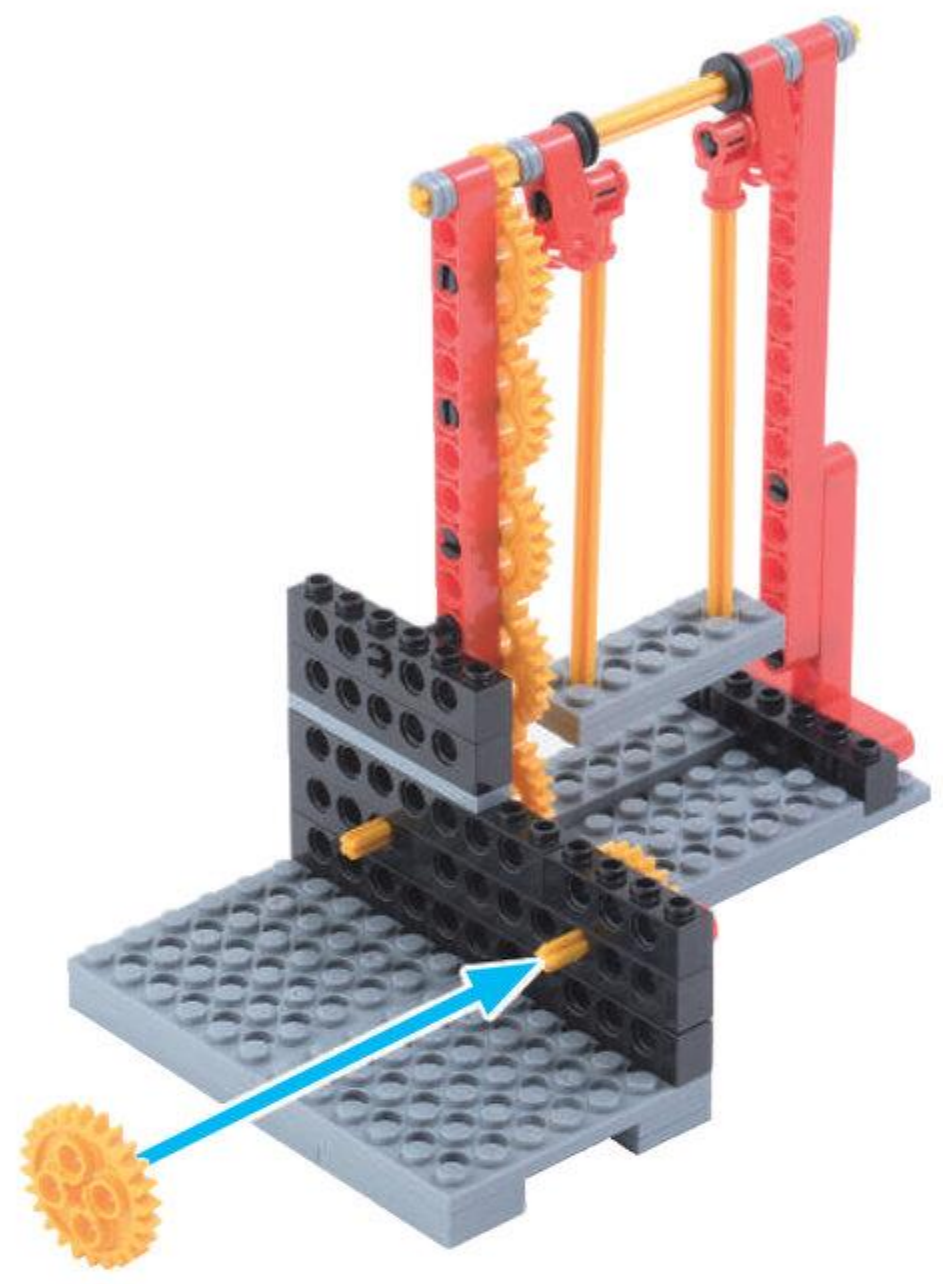

ふとぶれえとろくほち
太プレート6ポチ 1こ

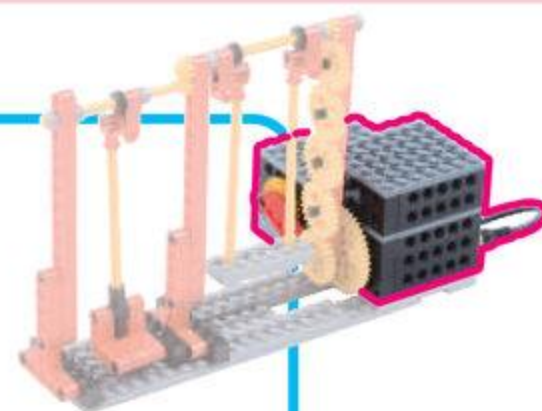

8

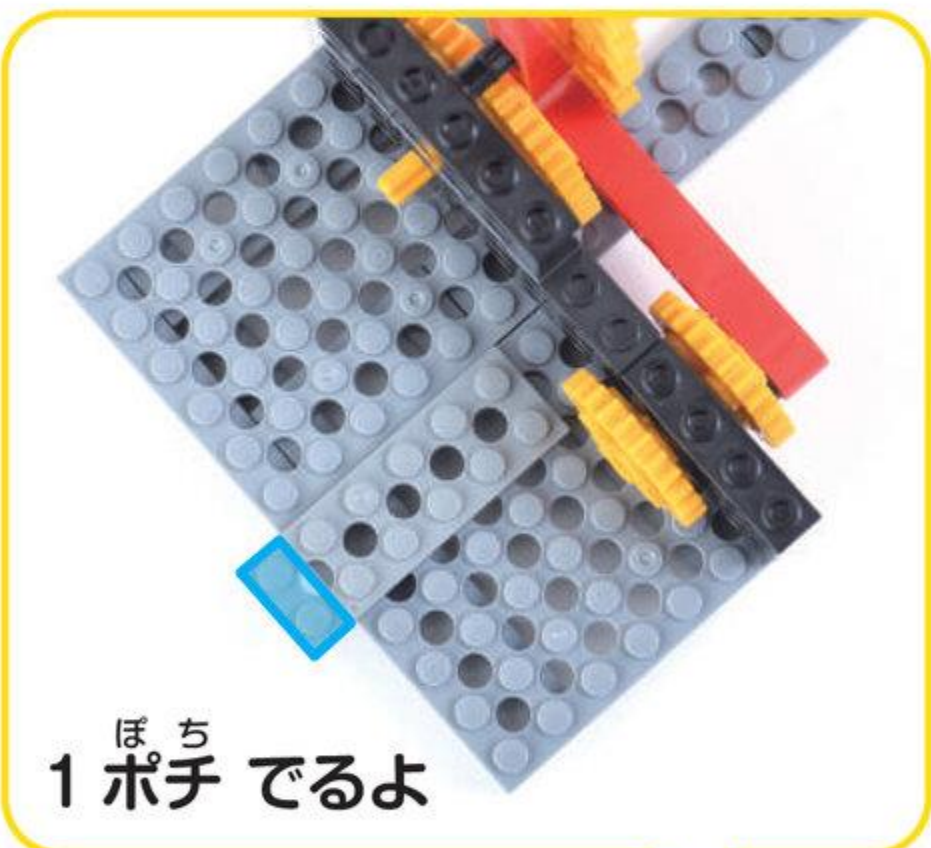
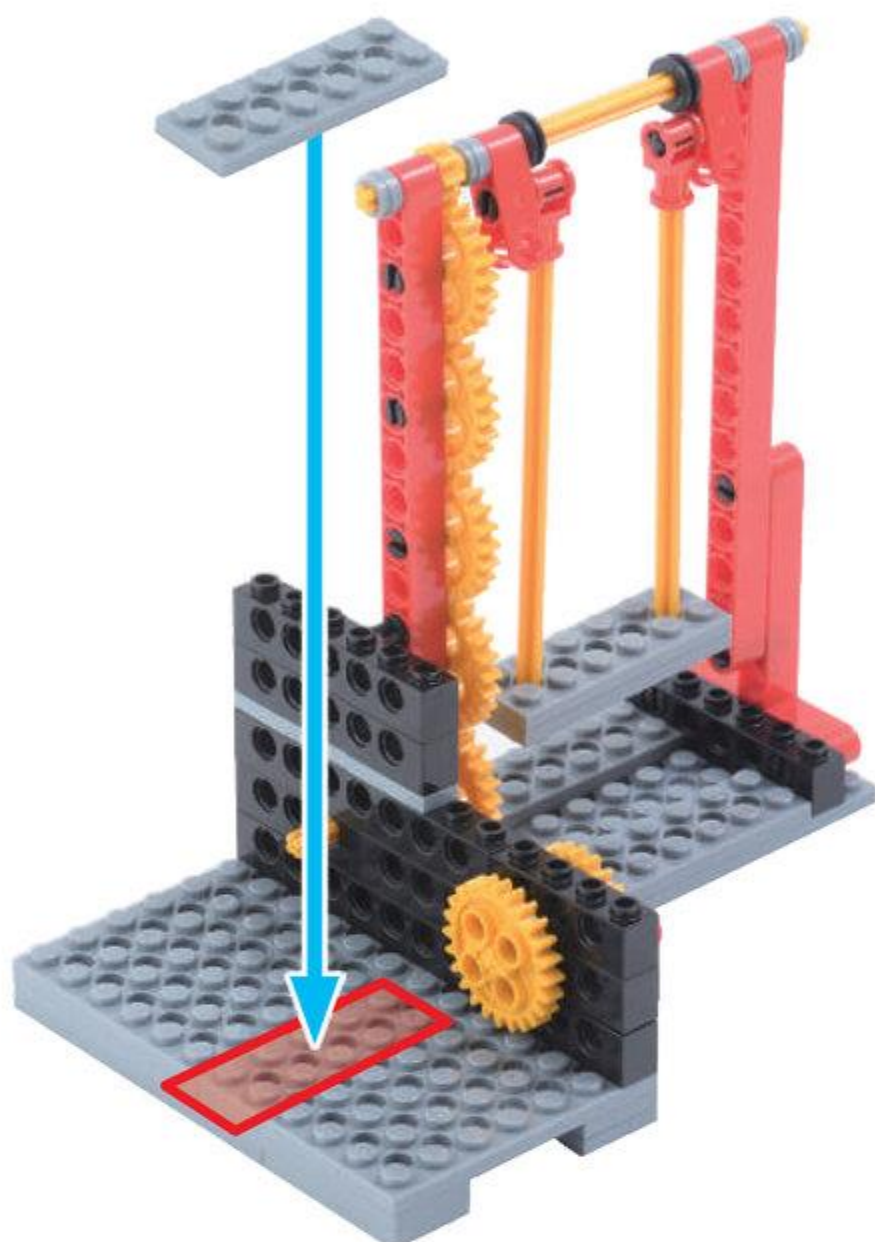

ほち
1ポチ であるよ

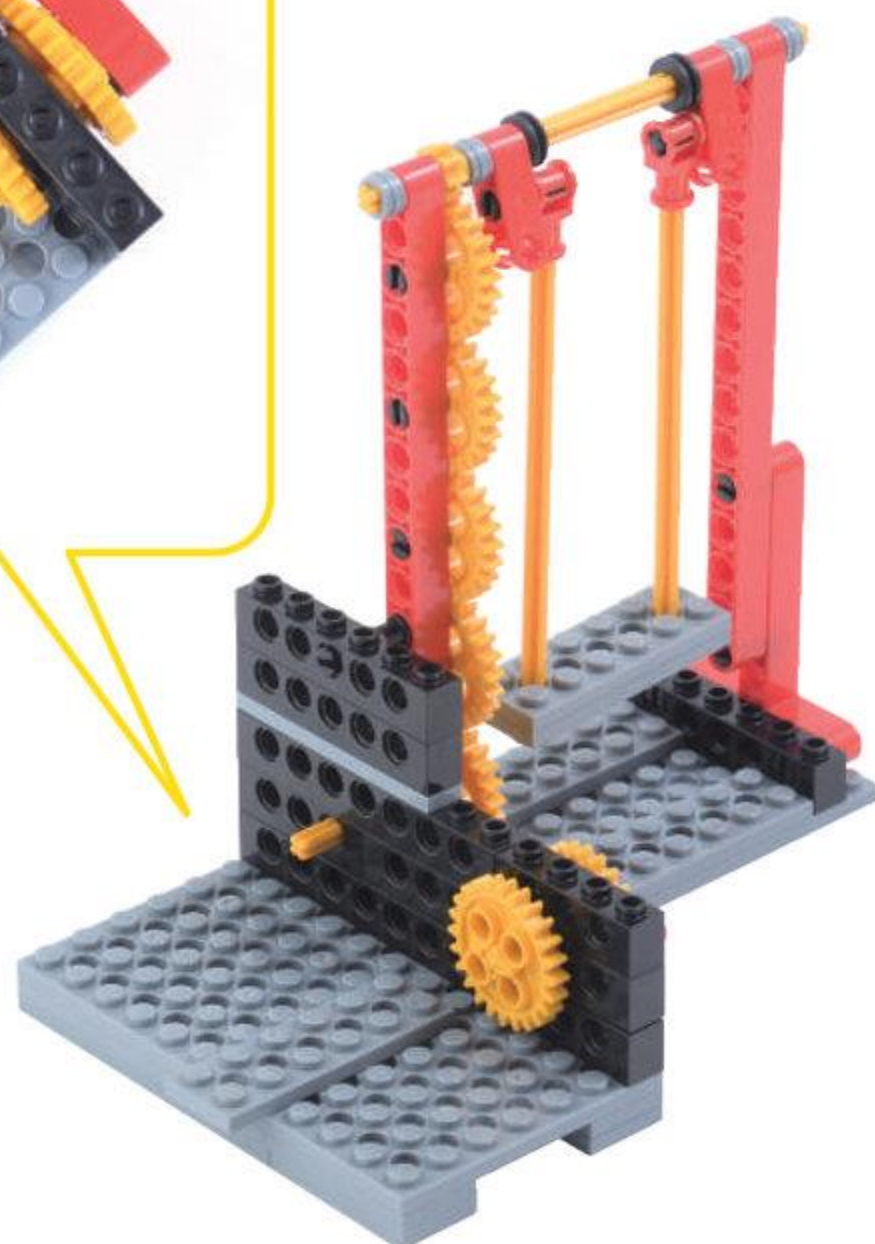

もおたあせつと
モーターセット 1こ

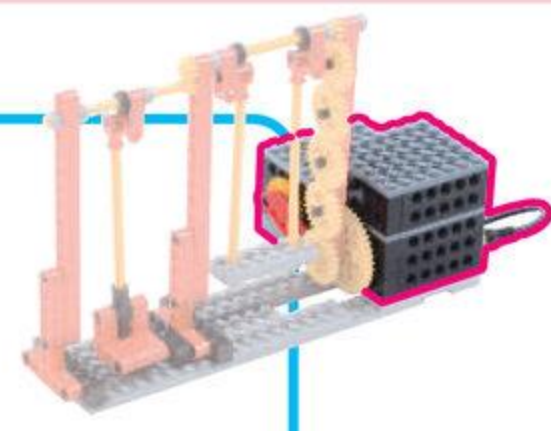
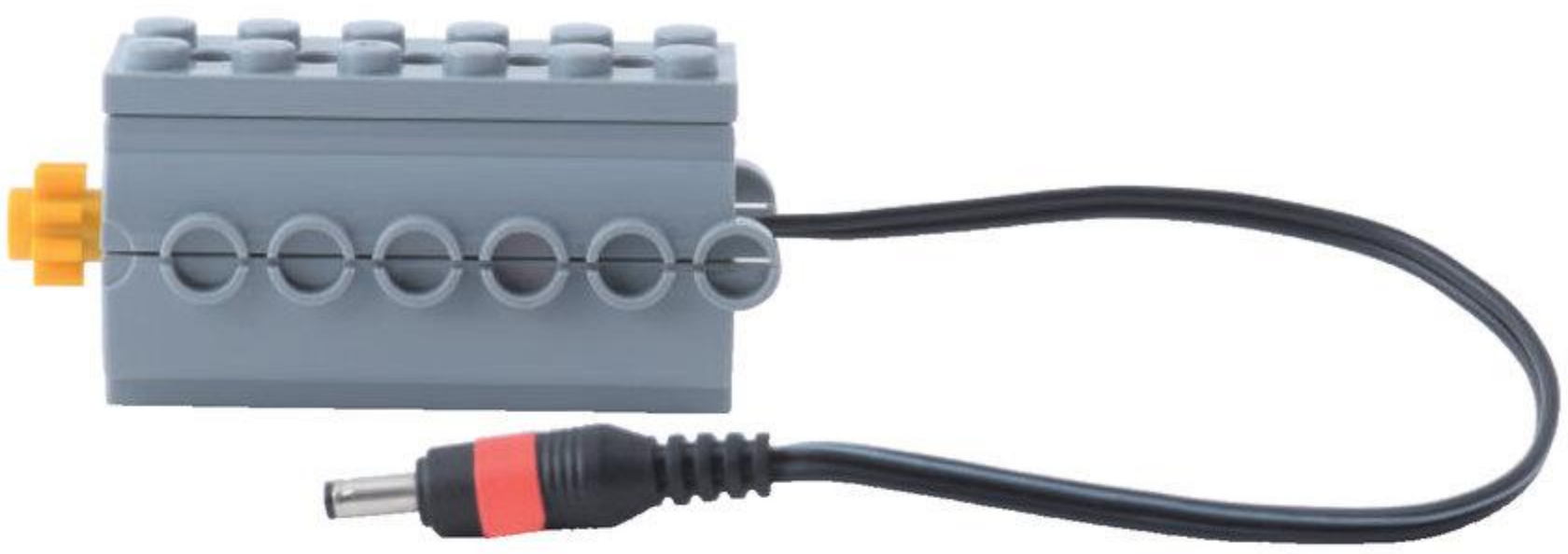

9

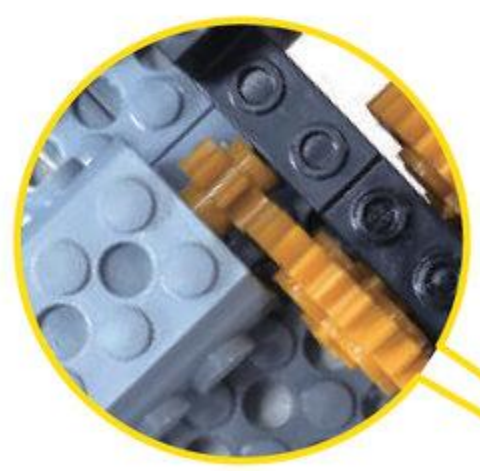
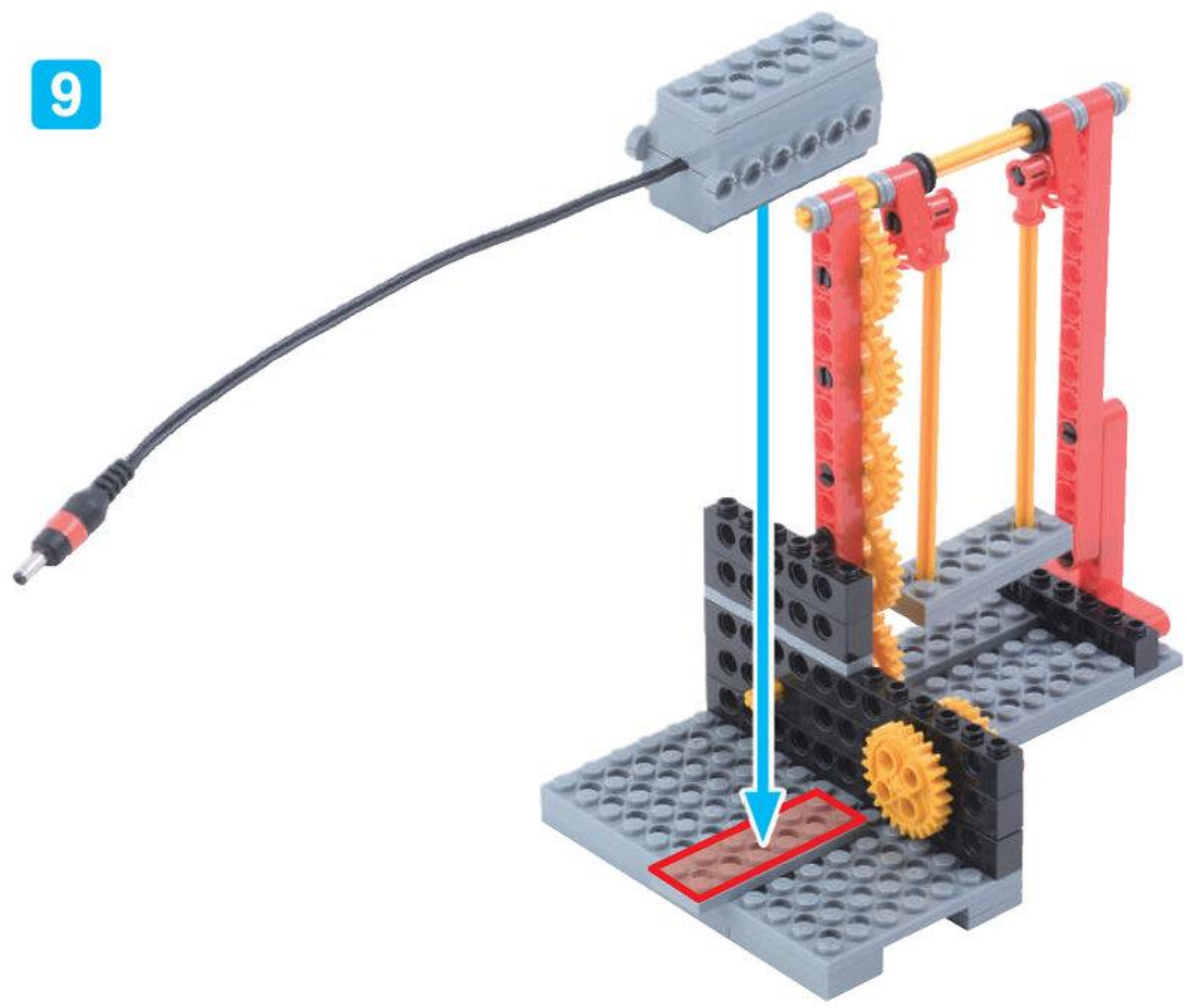

ぎあ
ギアを
かみあわせよう



びいむろくぼち
ビーム 6 ポチ 5 こ



ほそぶれえとろくぼち
細プレート 6 ポチ 1 こ

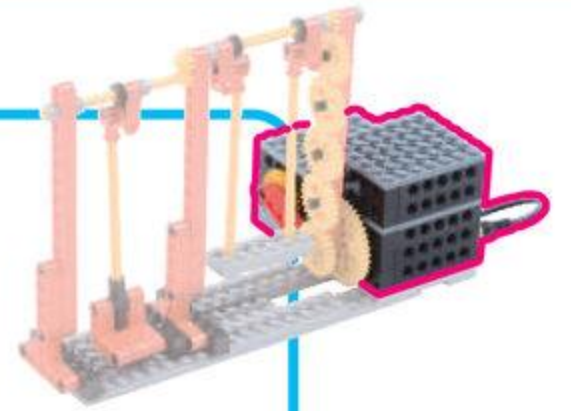

10

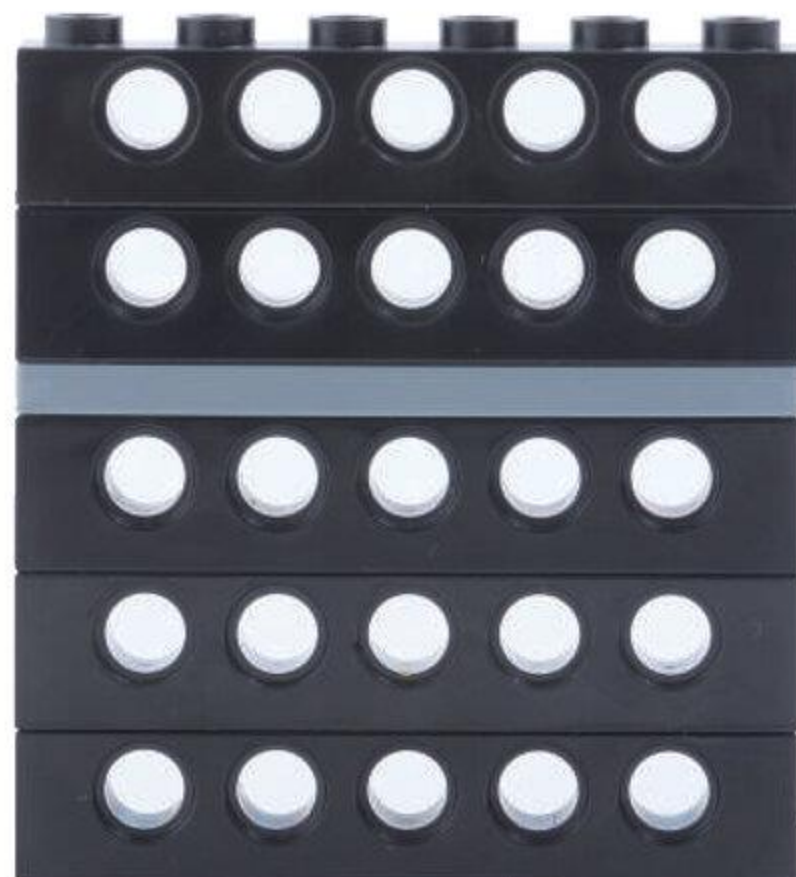

びいむろくほち
ビーム6ポチ 3こ

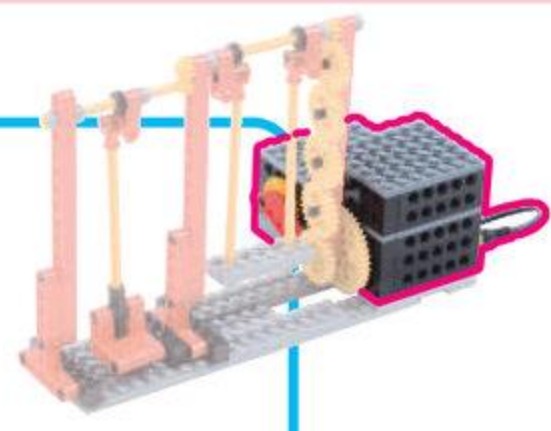

11



12

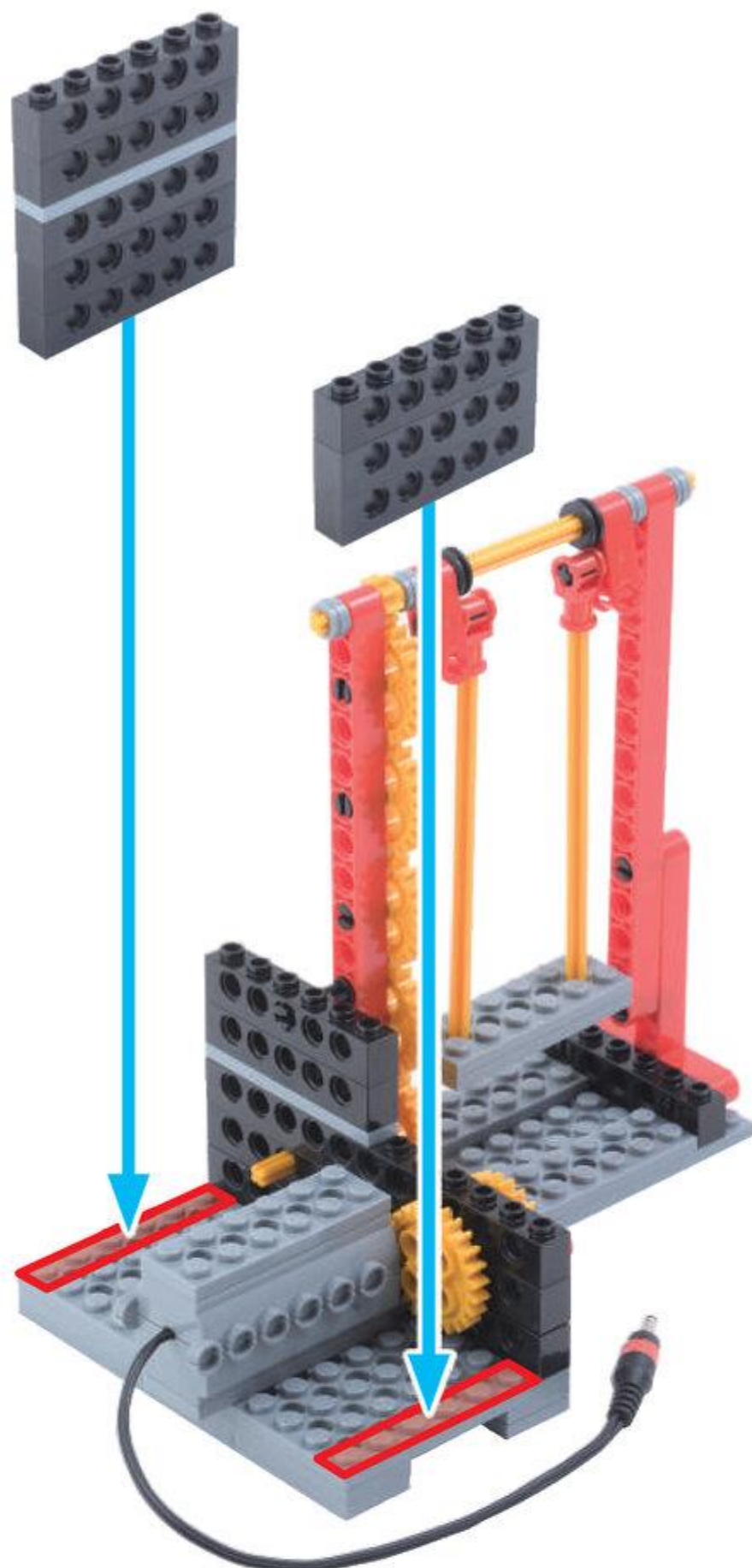
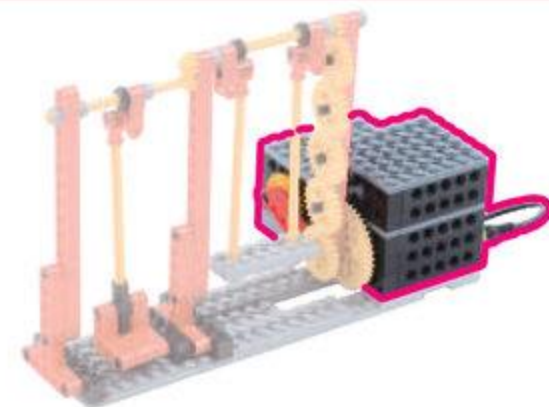

ばってりいぼくす すらいどすいっち **1**こ
バッテリーボックス / スライドスイッチ

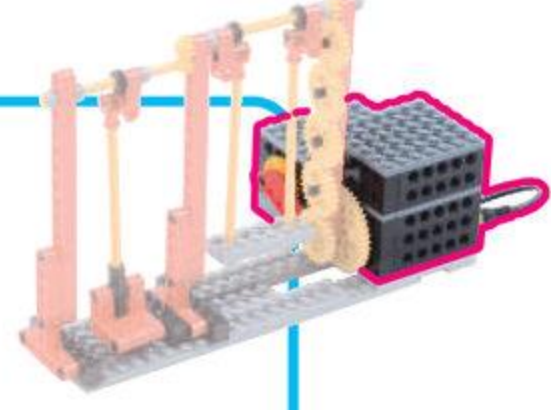

たっちせんさあくろ **1**こ
タッチセンサー黒



13

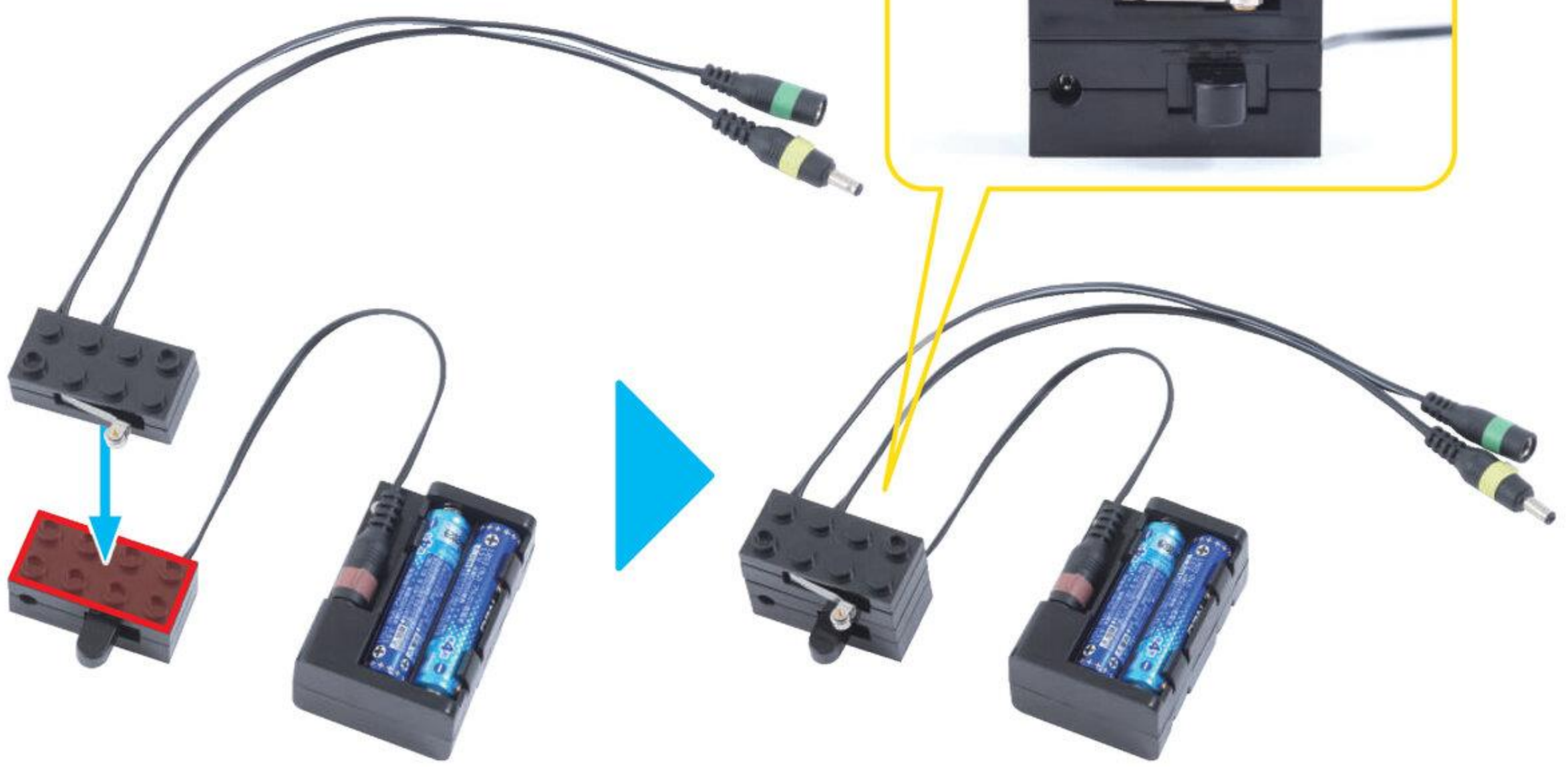

14

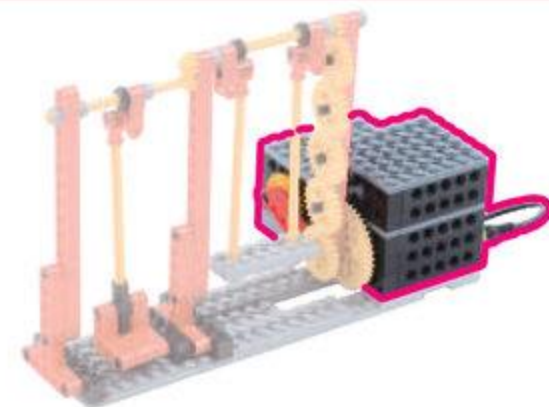

ぼってりいほっくす
バッテリーボックスは
おくだけだよ

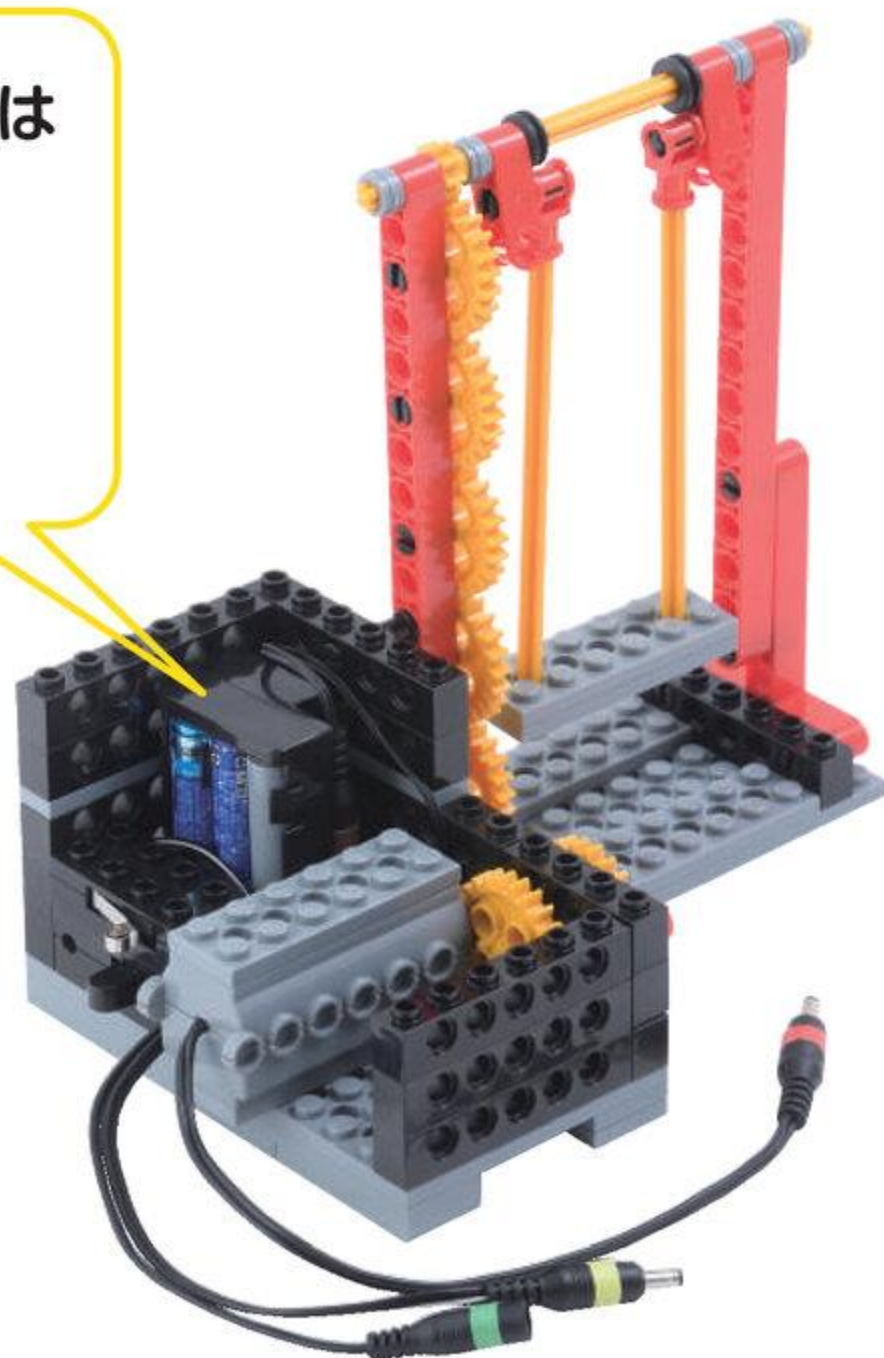
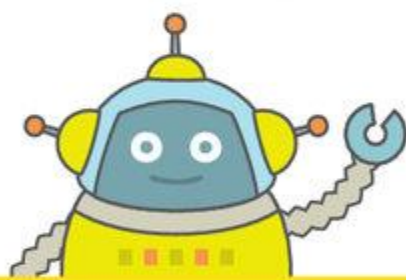

びいむよんほち
ビーム 4 ポチ 3 こ

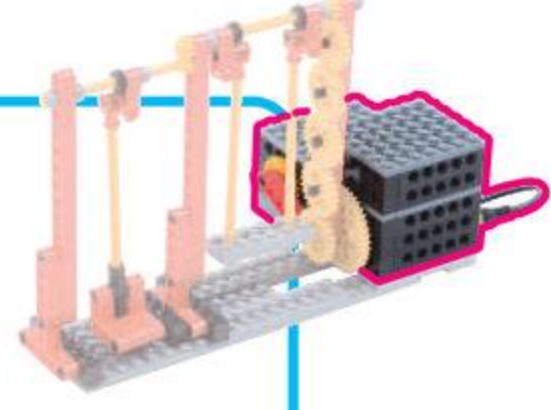

15



16

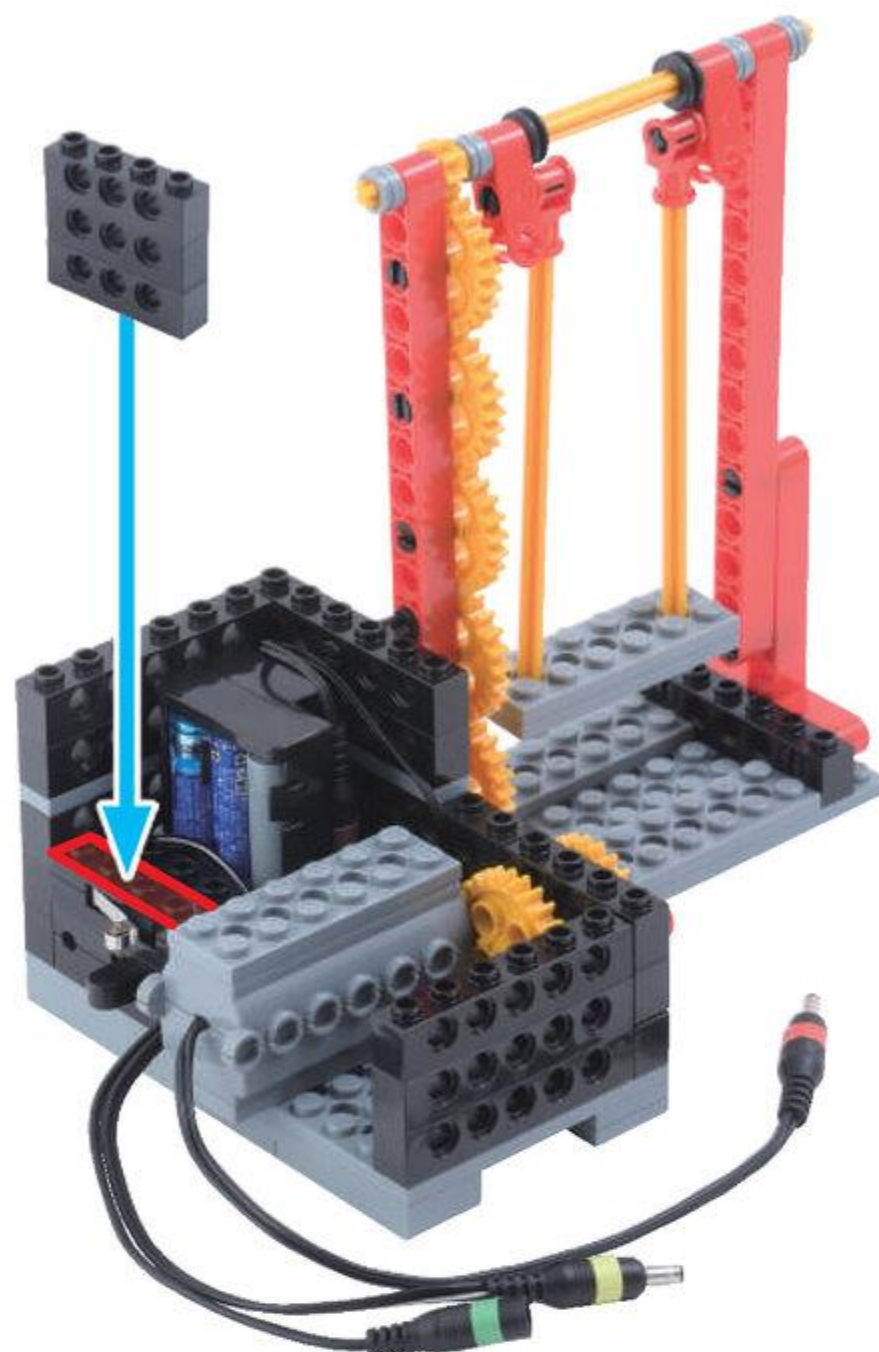
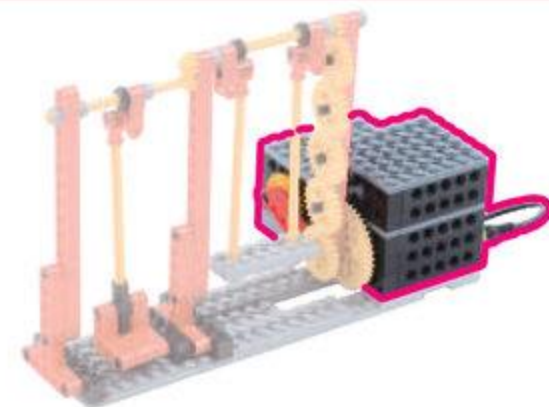

17

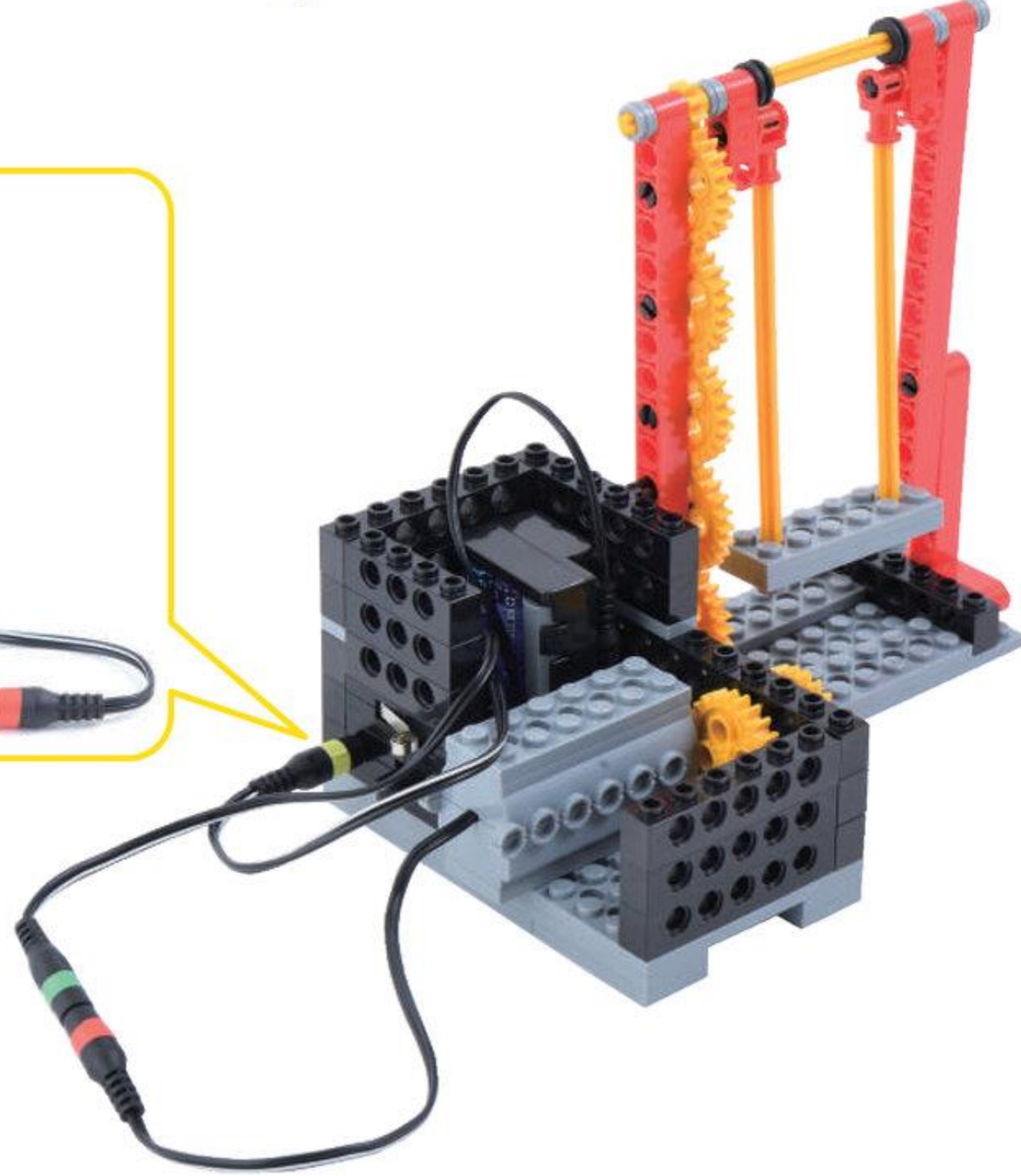
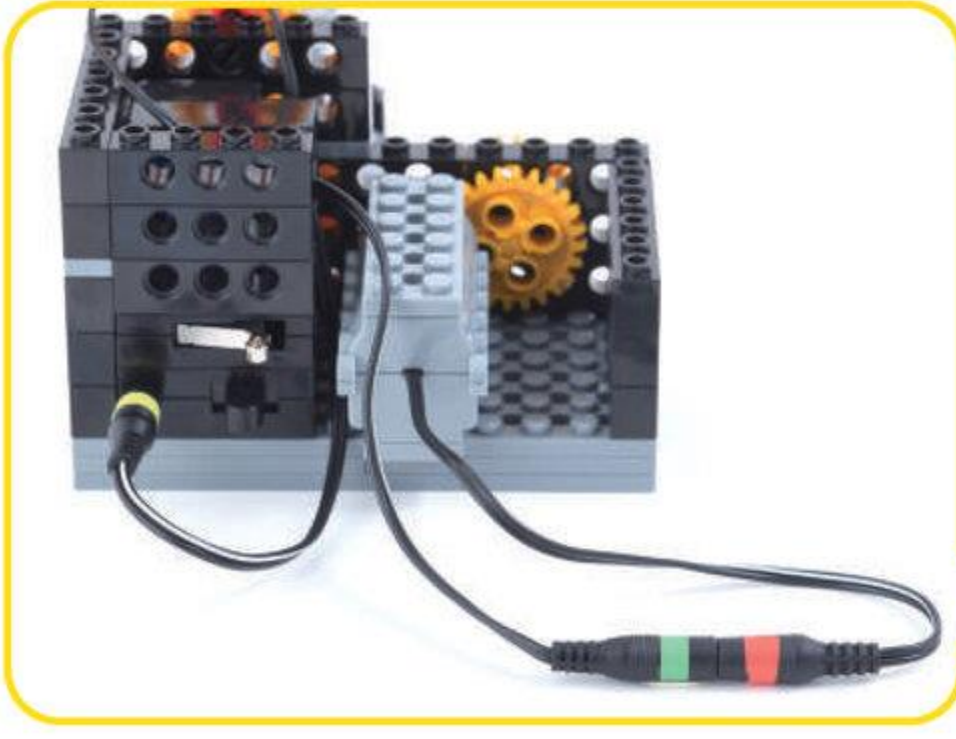
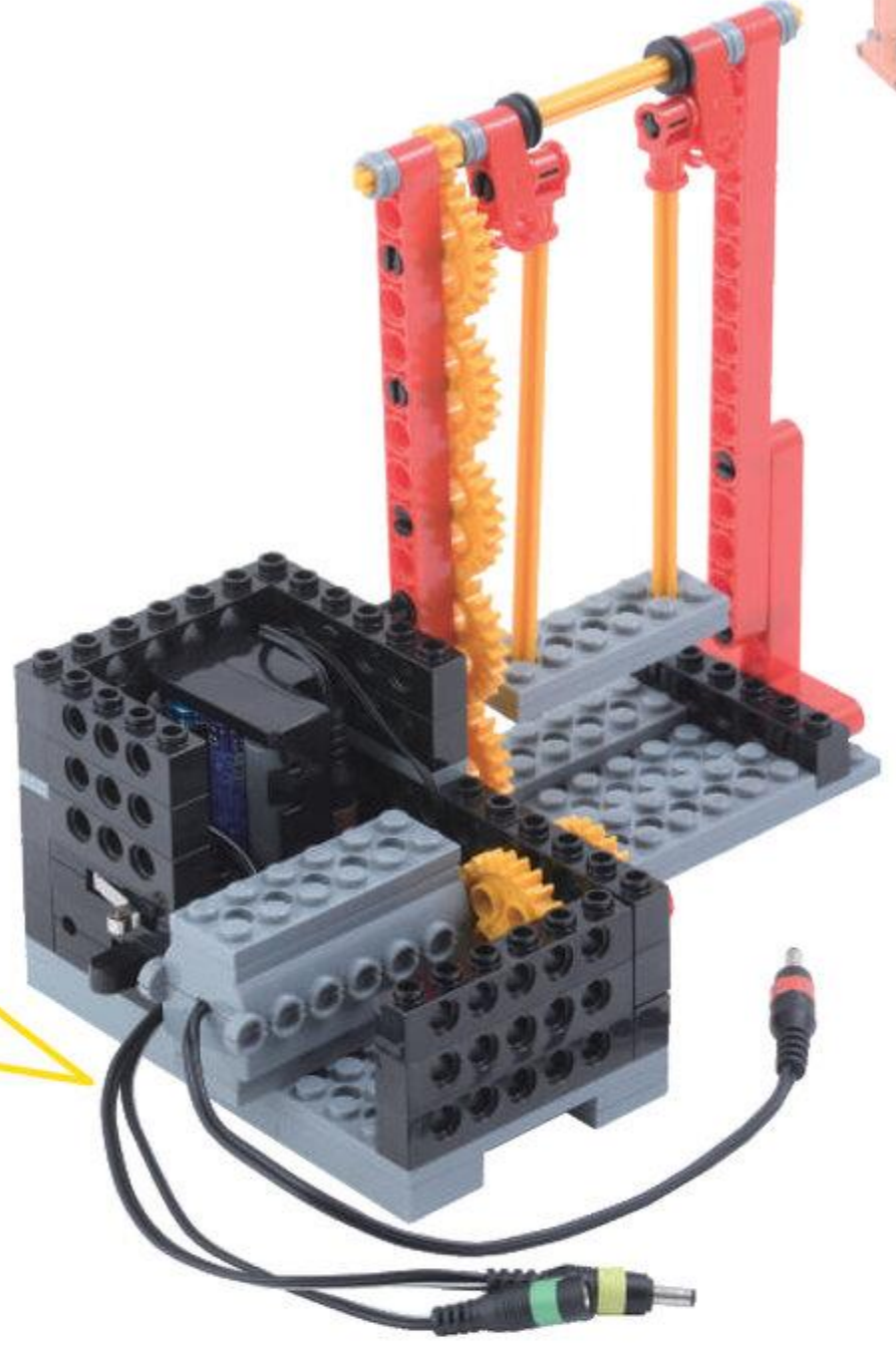
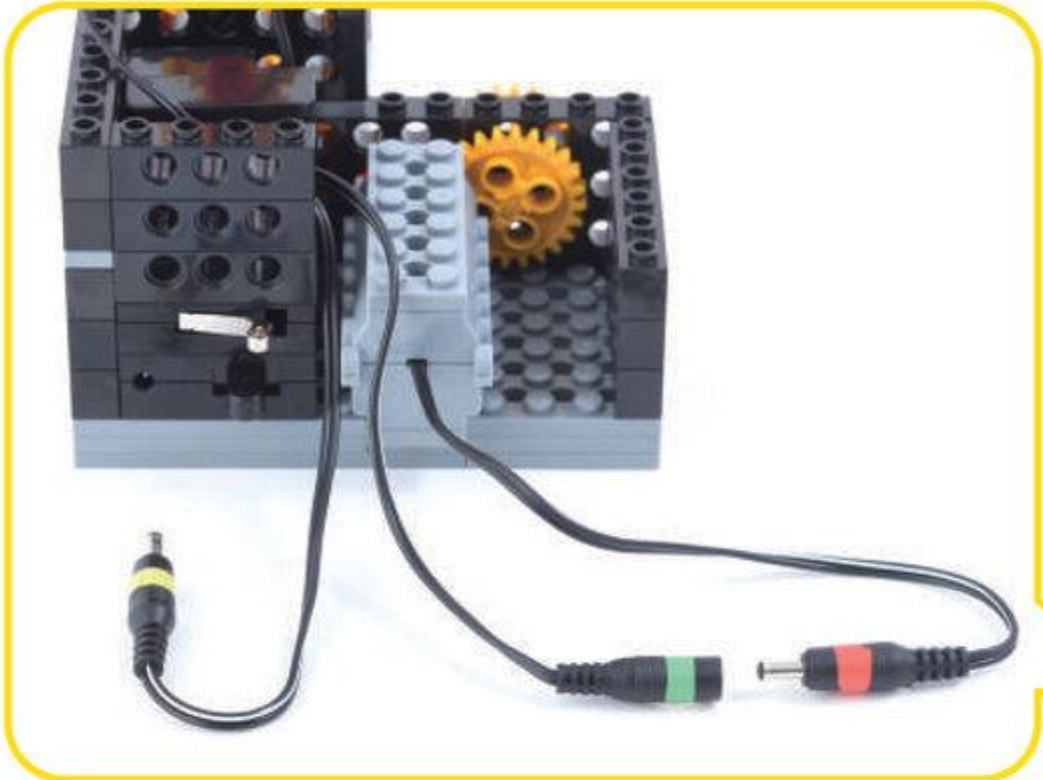
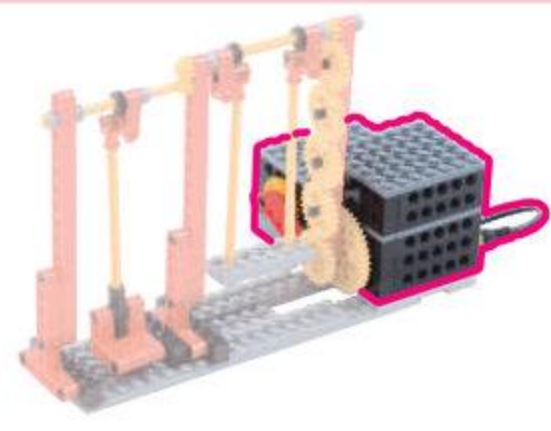

コードを
おど
ただしく
つなごう

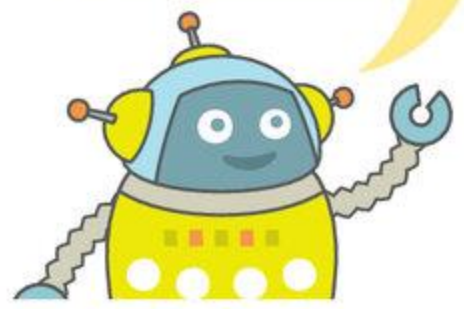

18

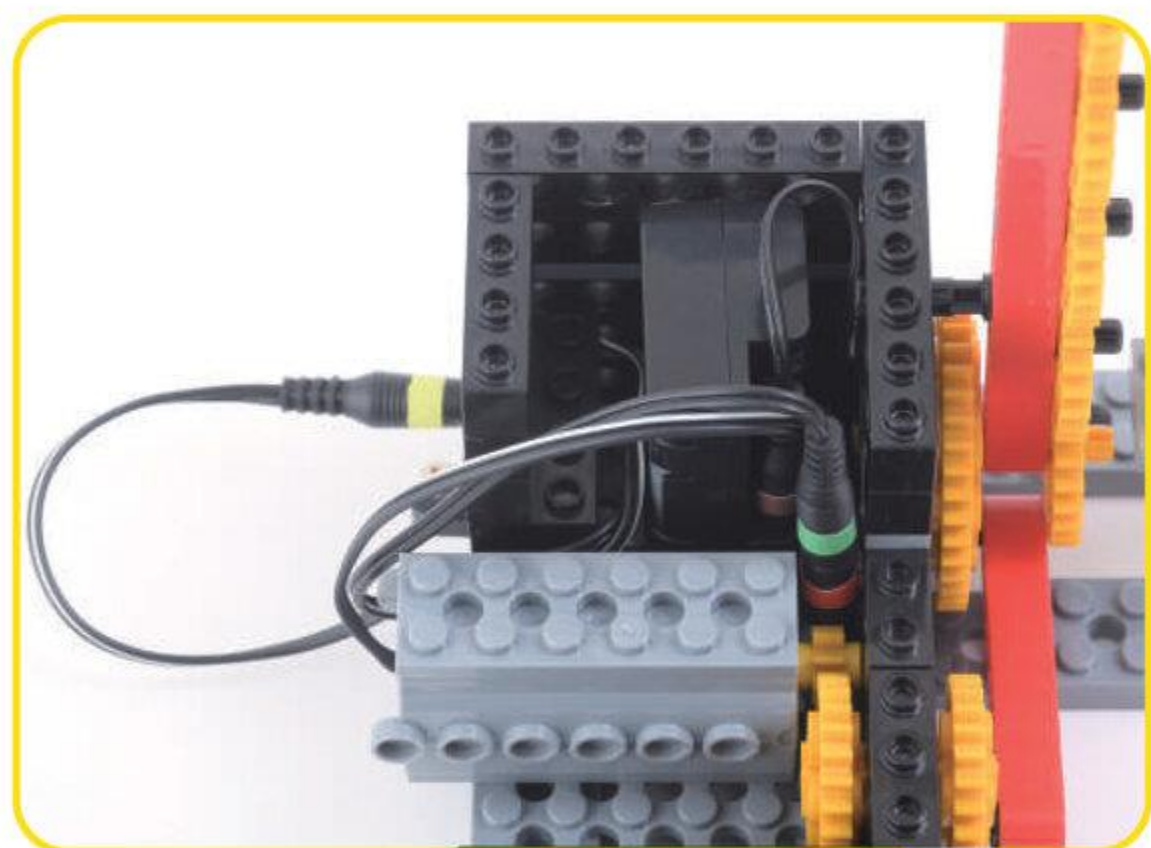
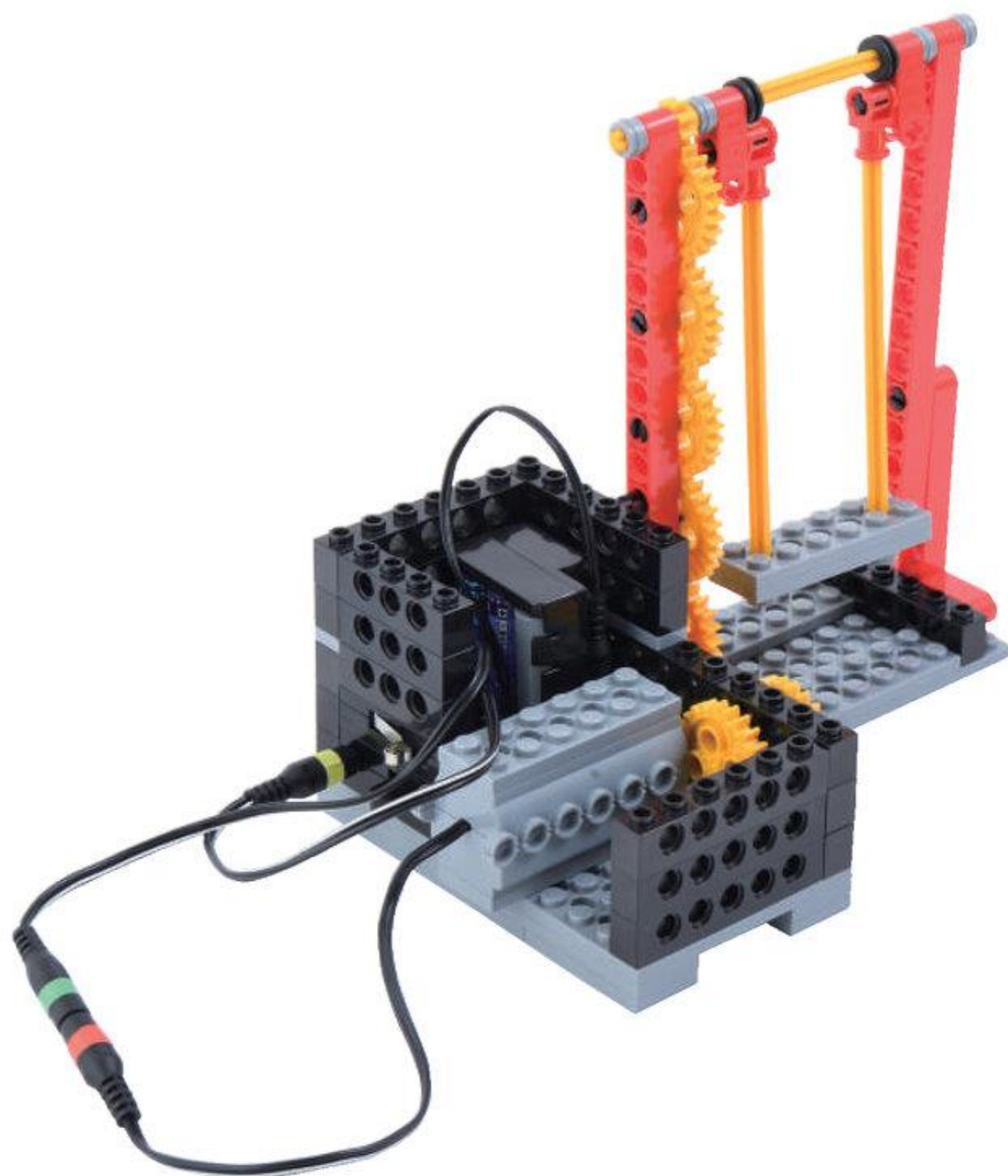

こおど
コードを たたんで
いれよう

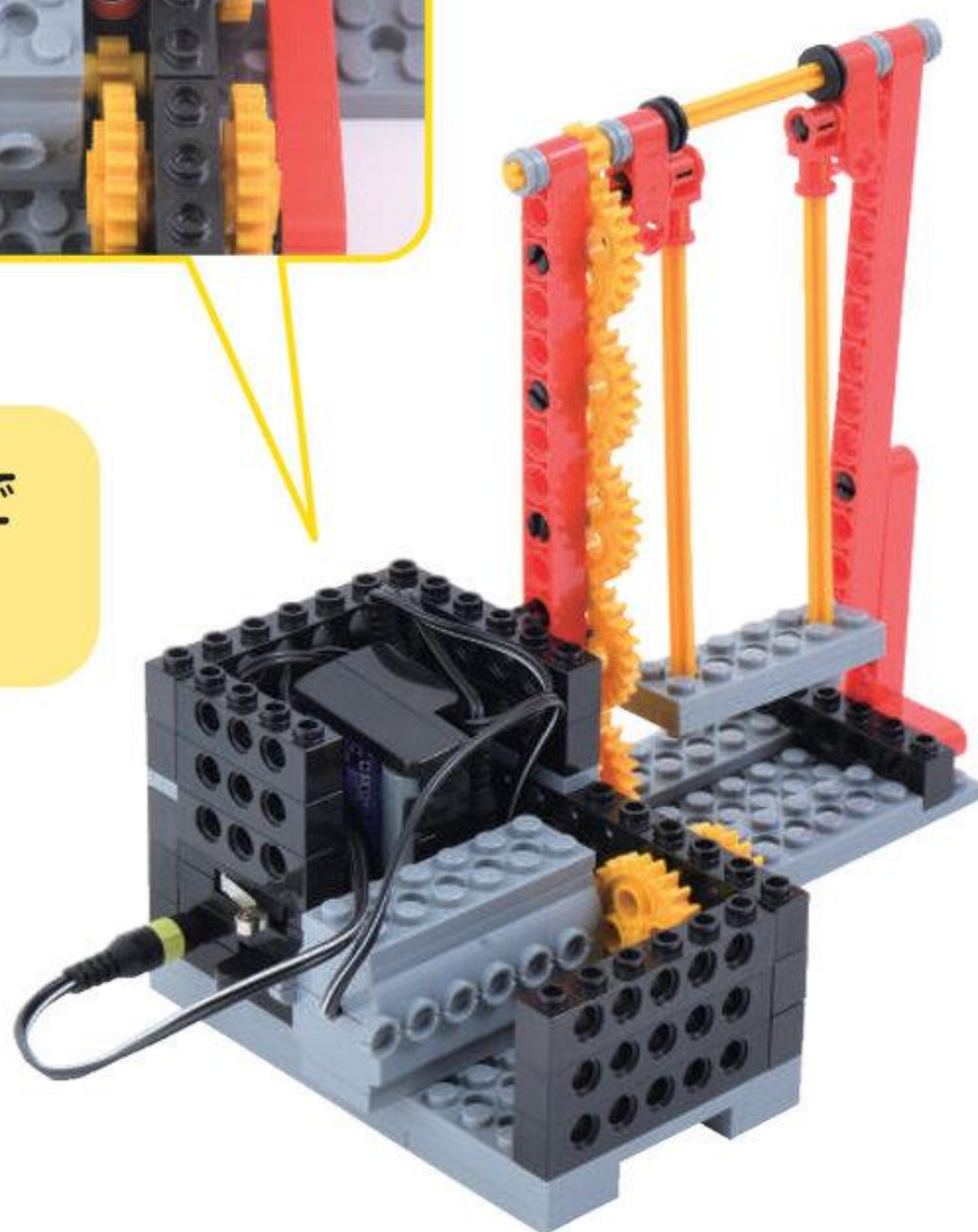
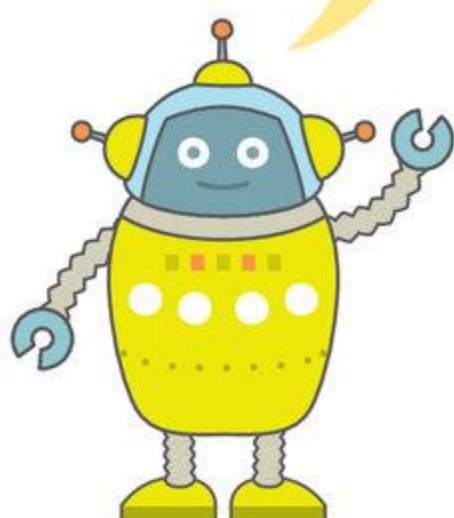

ぶれえとる
プレート **2**こ

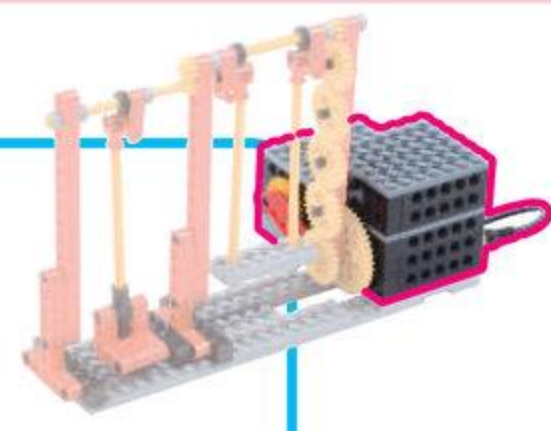
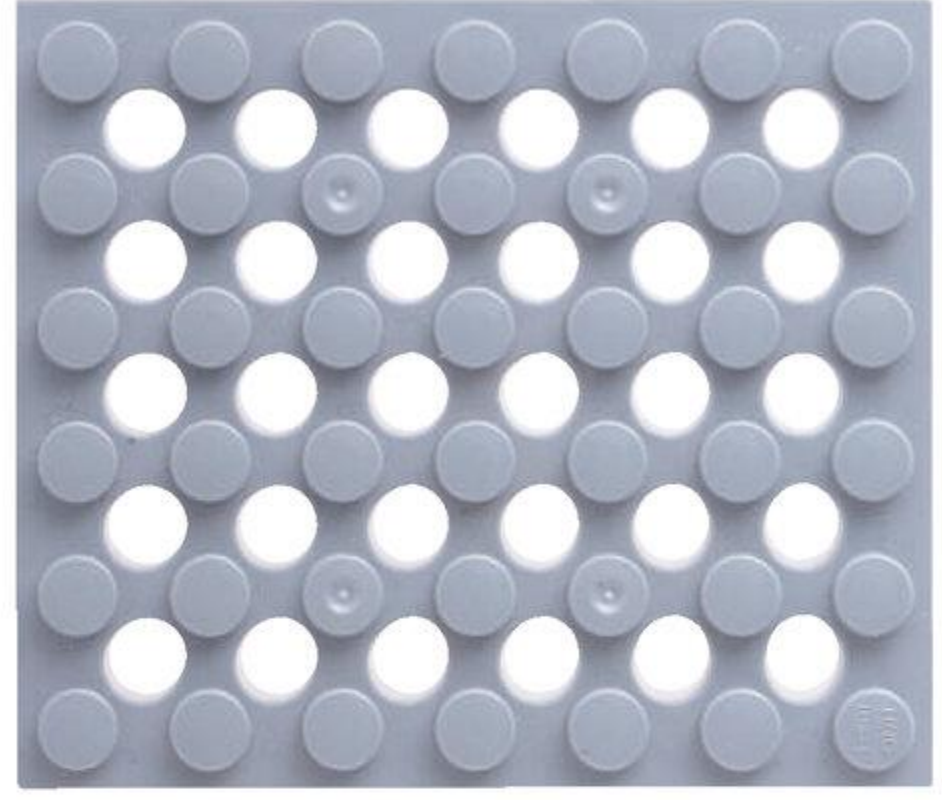

19

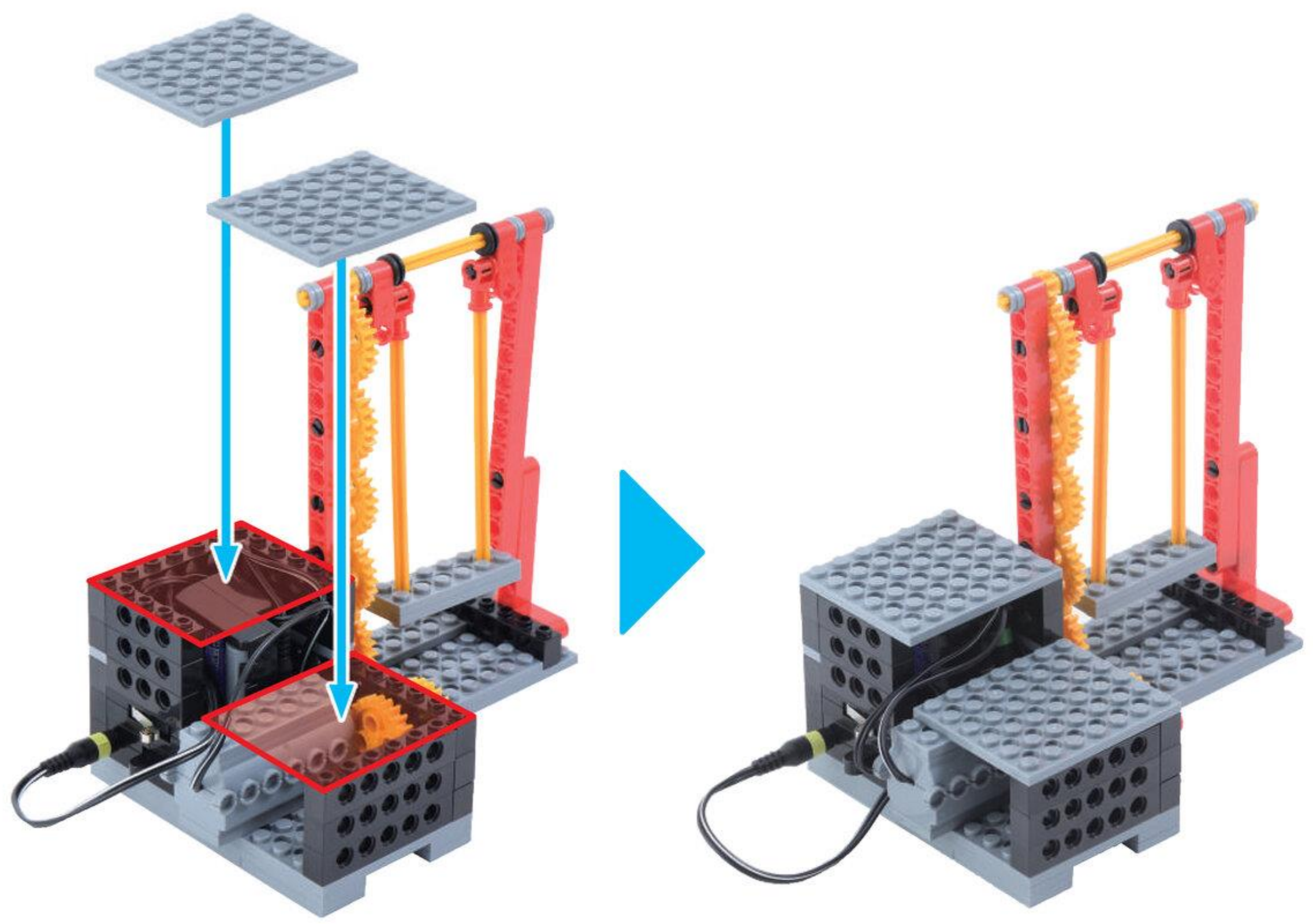

ぎあほっくす
ギアボックスが
かんせい!

やったね!

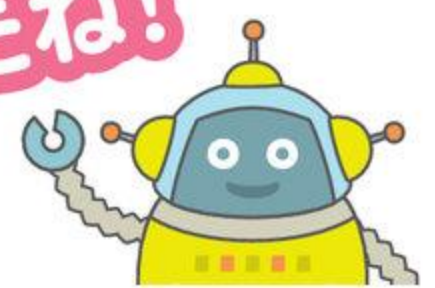

ロボットをうごかそう

めやす 5 ぶん

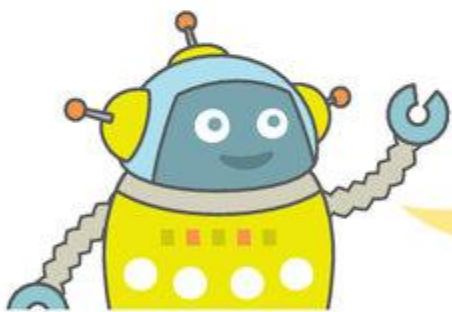
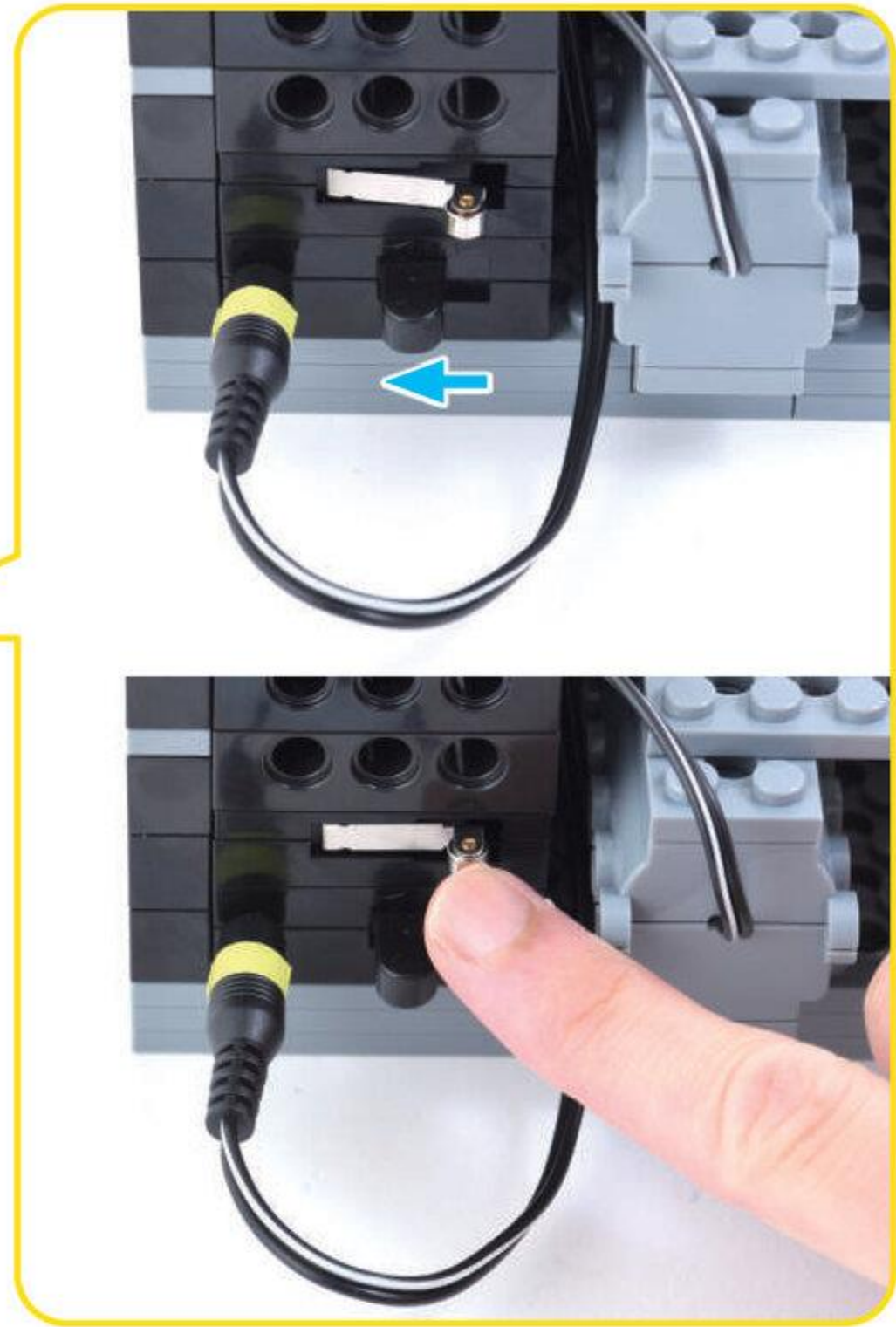
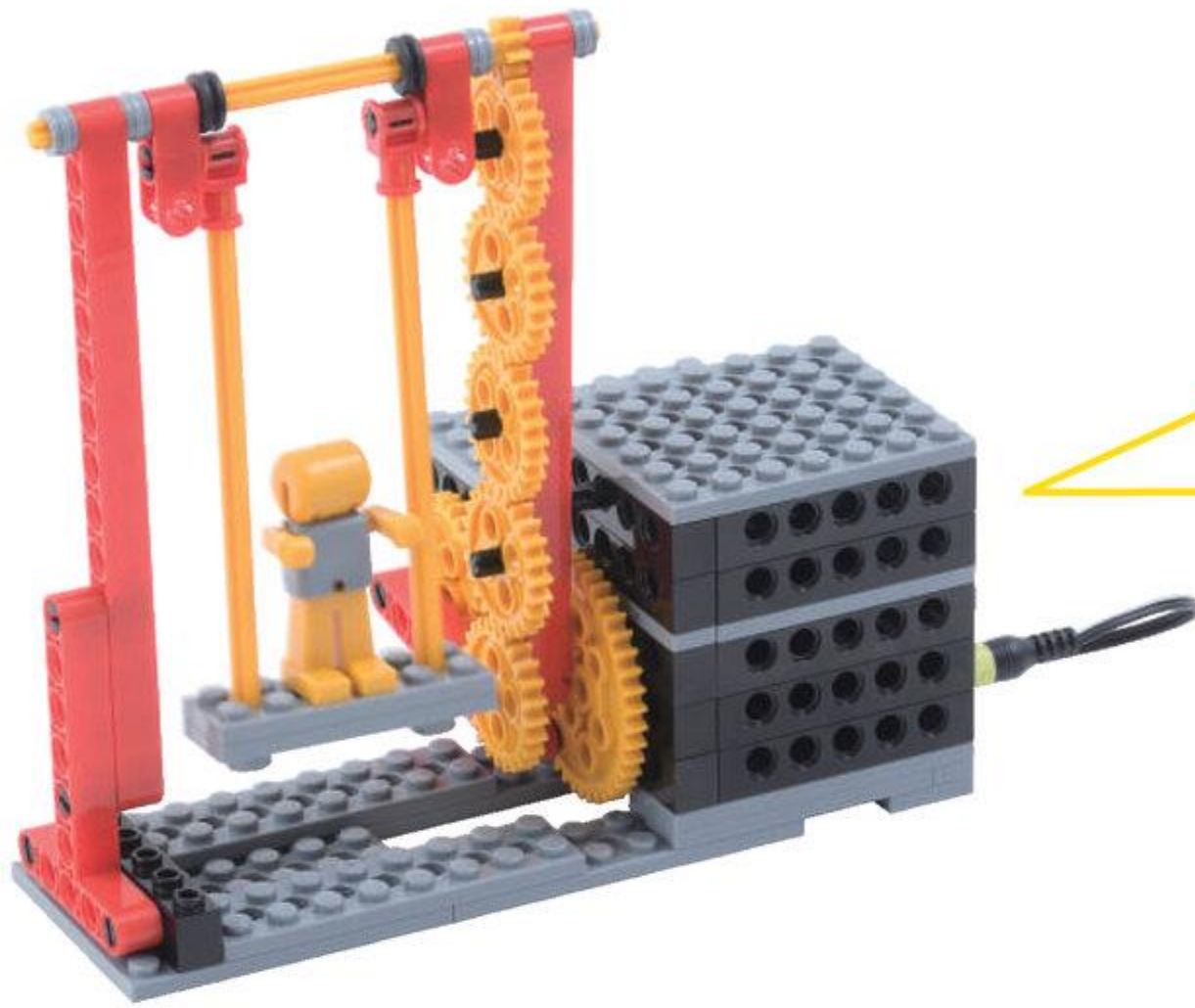

やじるしのむきに ^{すいっち} スイッチをいれて
^{たっちせんさあ} タッチセンサーをおしてみよう!

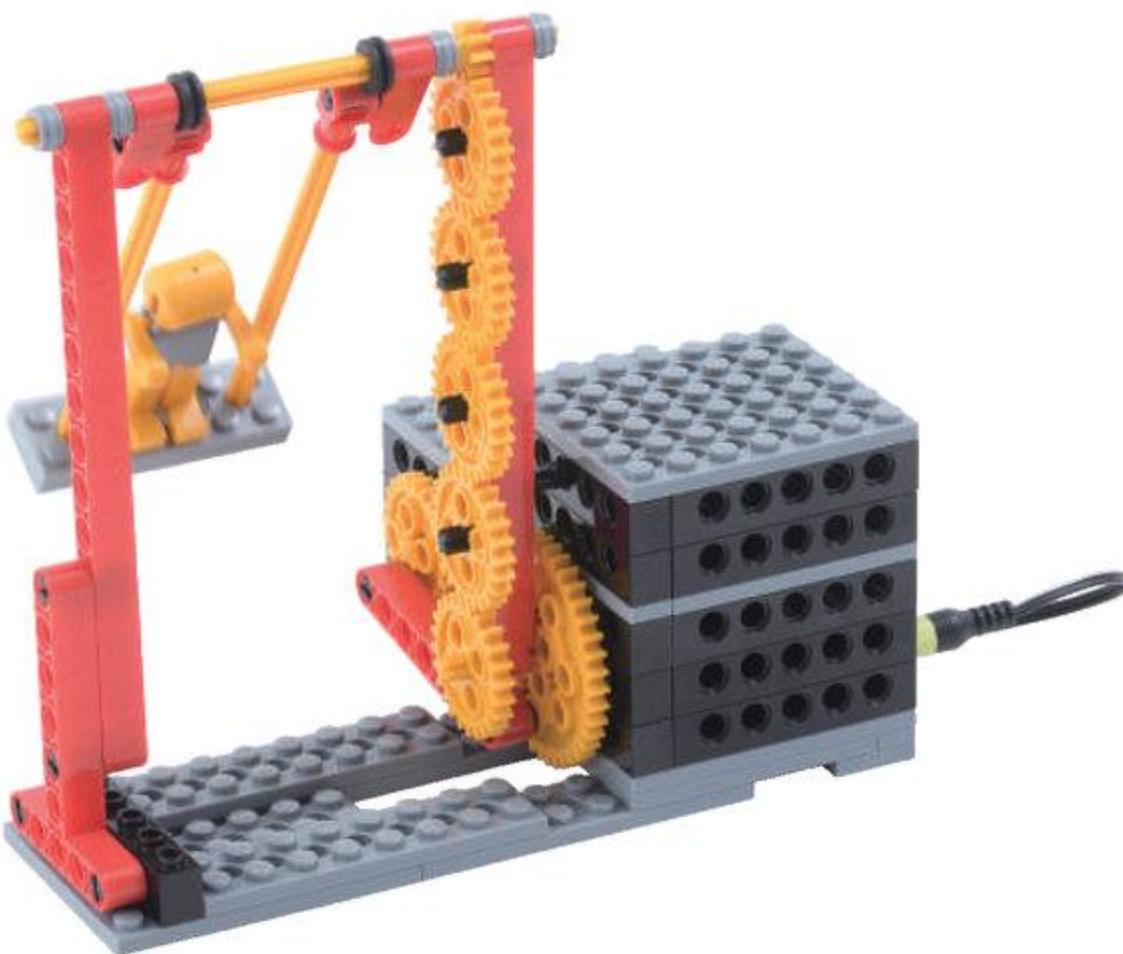

うごかし おわったら ^{すらいどすいっち} スライドスイッチを まんなかに もどそう

2 あたらしい じめん

めやす 5 ぶん

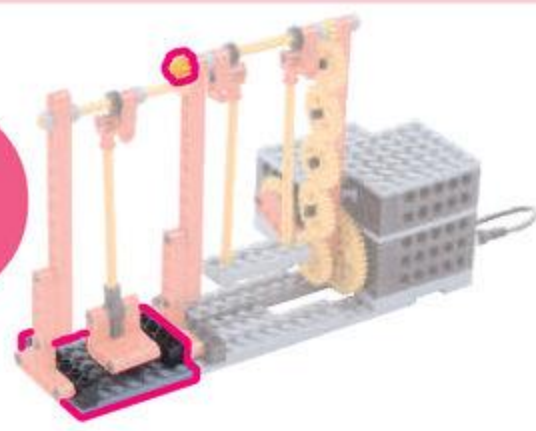

1

はずす

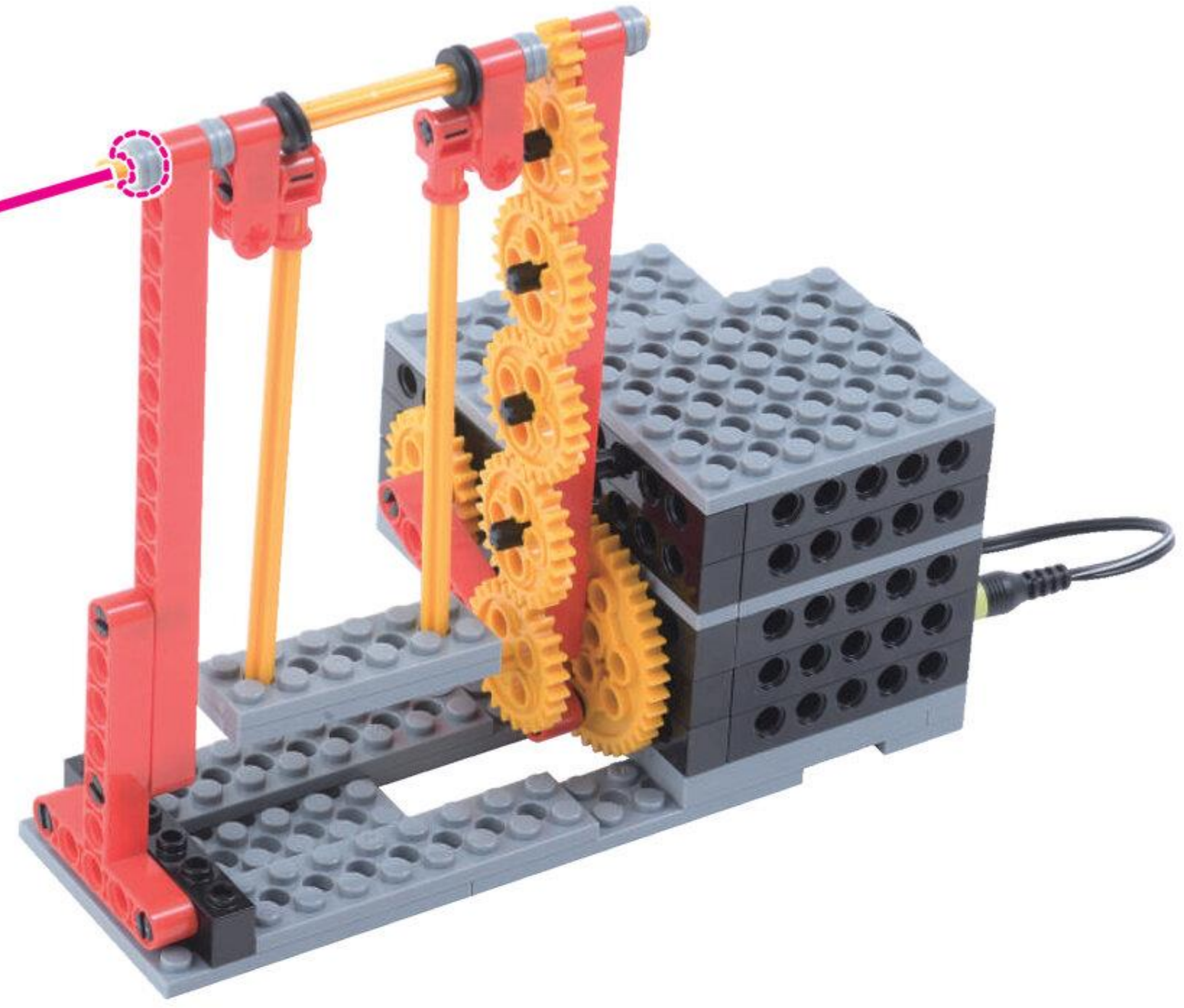

はずした ^{ばあっ} パーツは
しまおう

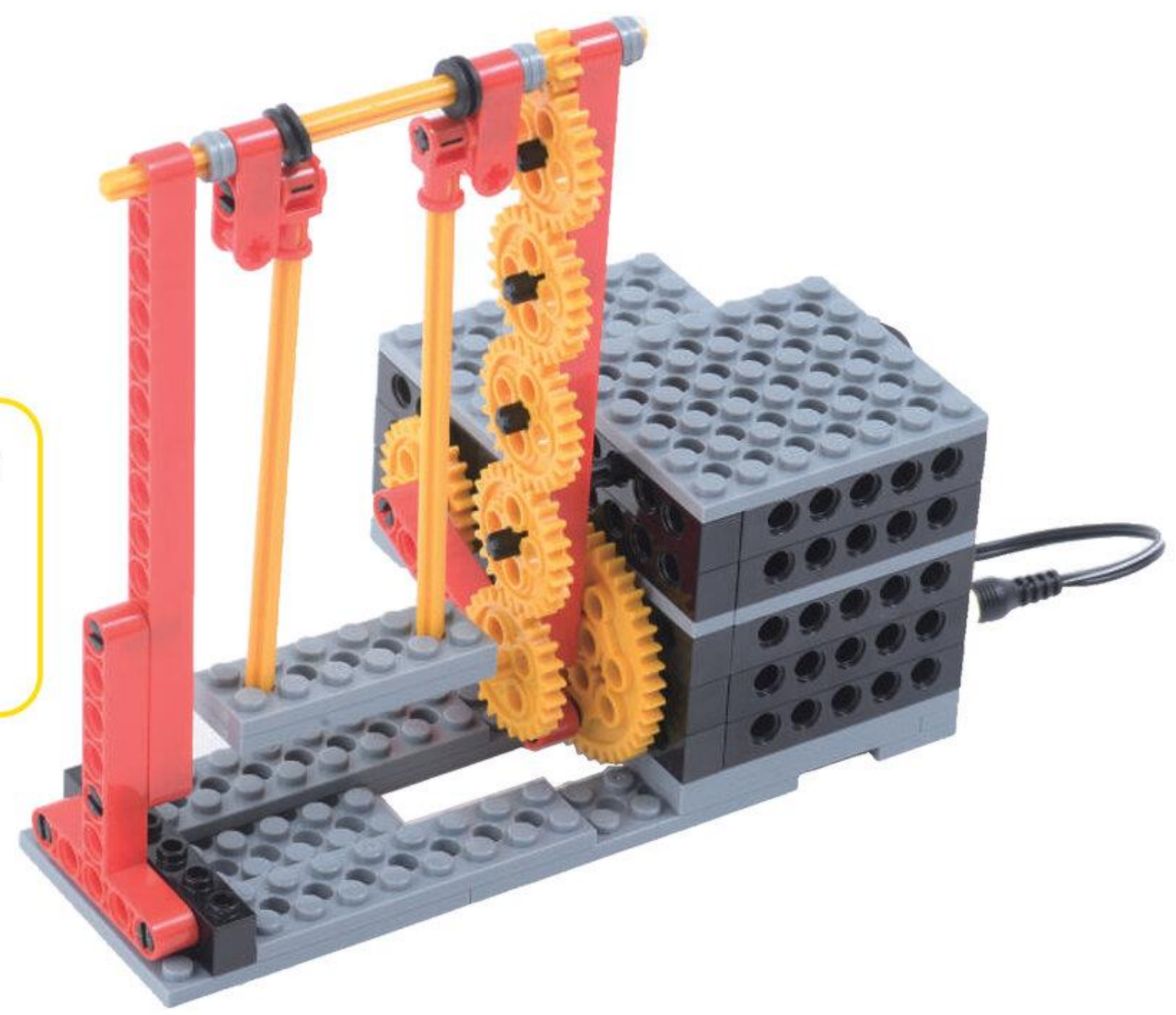

びにおんぎあ
ピニオンギアうす 1こ

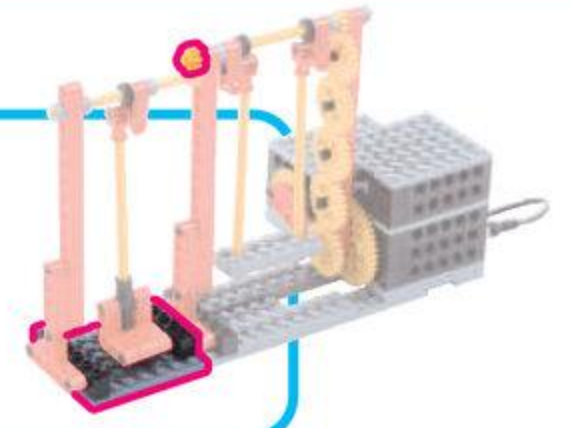

2

むきに ちゅうい



こちらを
さしこむ

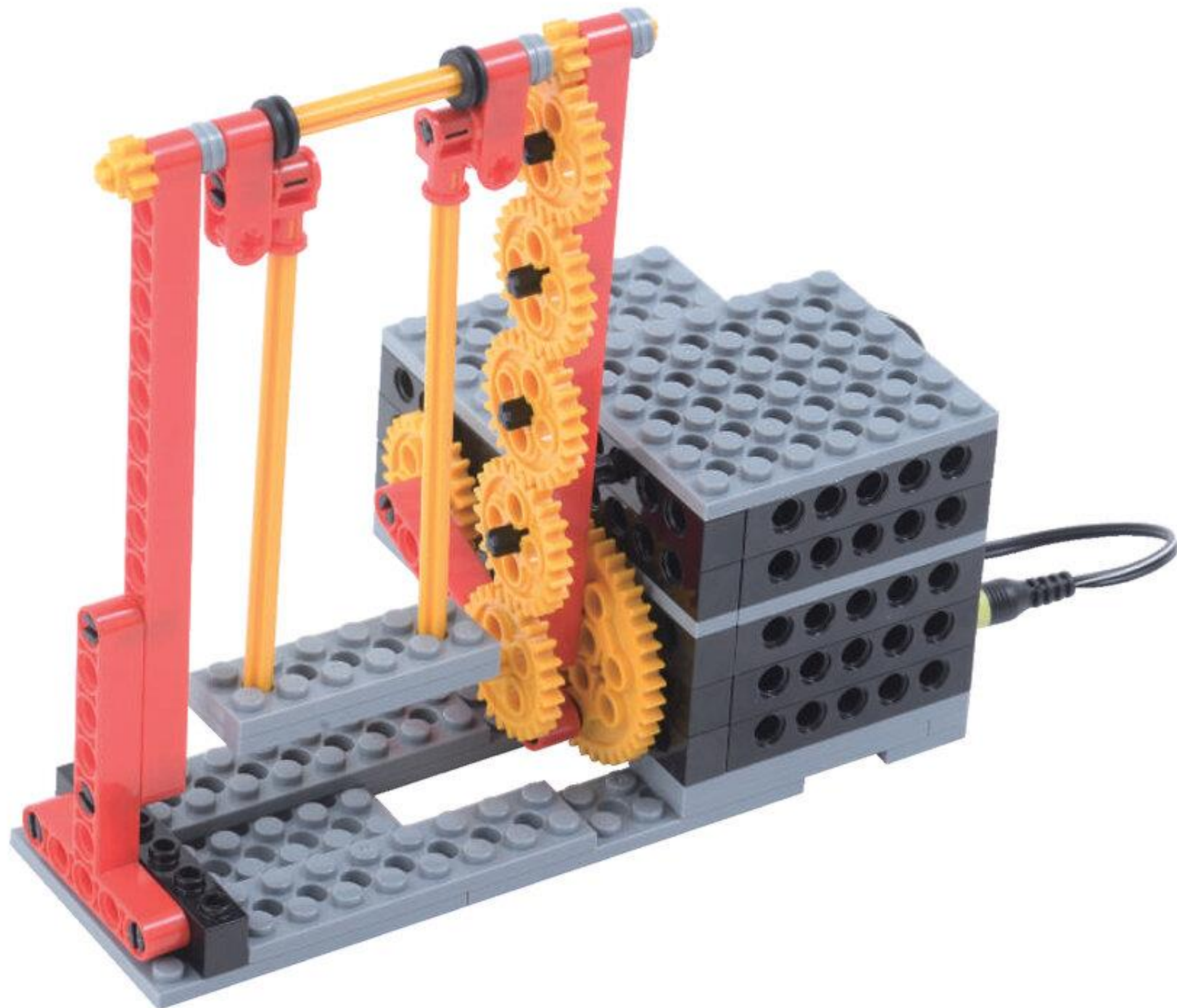
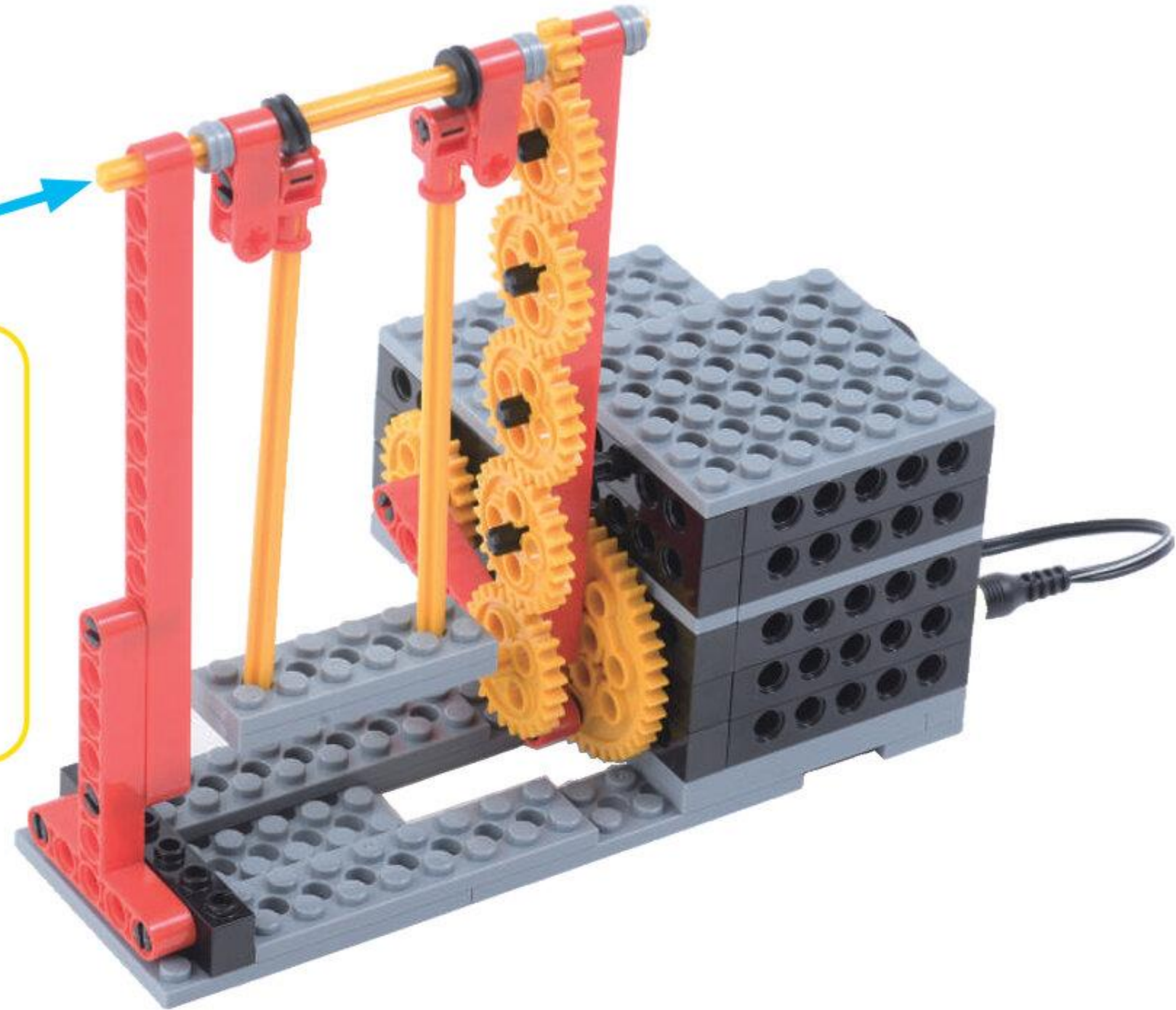

ぶれえとる プレートL 1こ

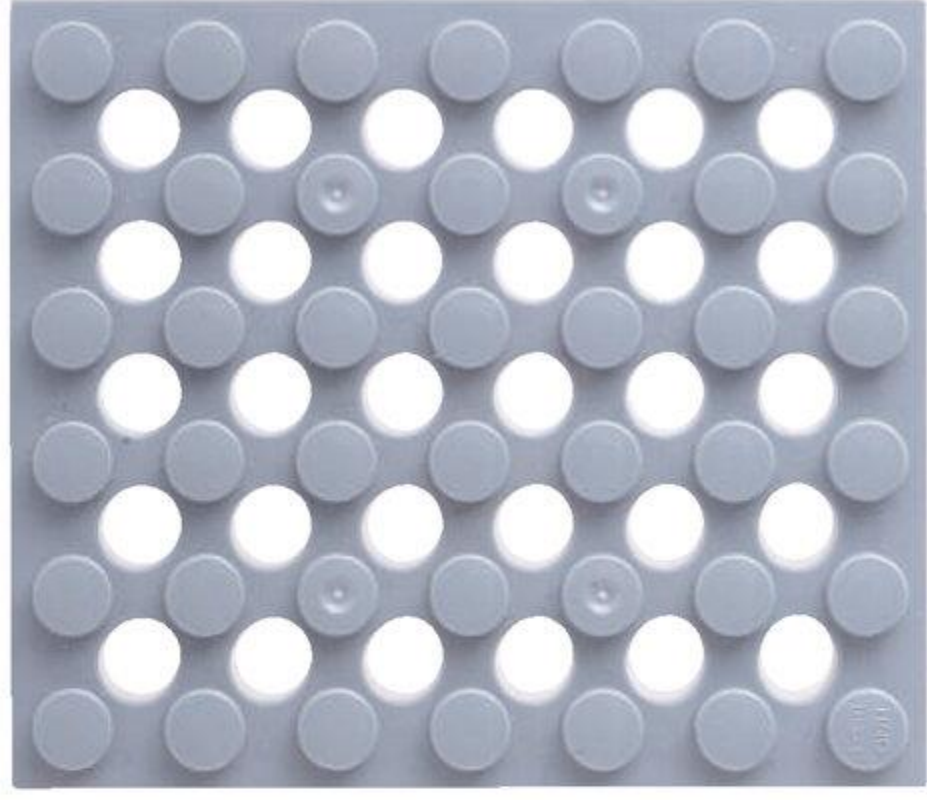

びいむろくほち ビーム6ポチ 1こ



びいむよんほち ビーム4ポチ 1こ

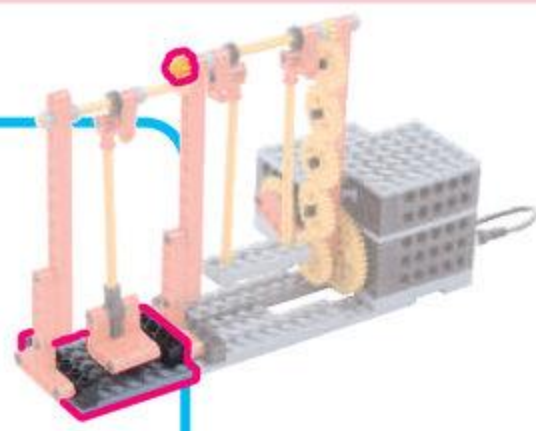

3

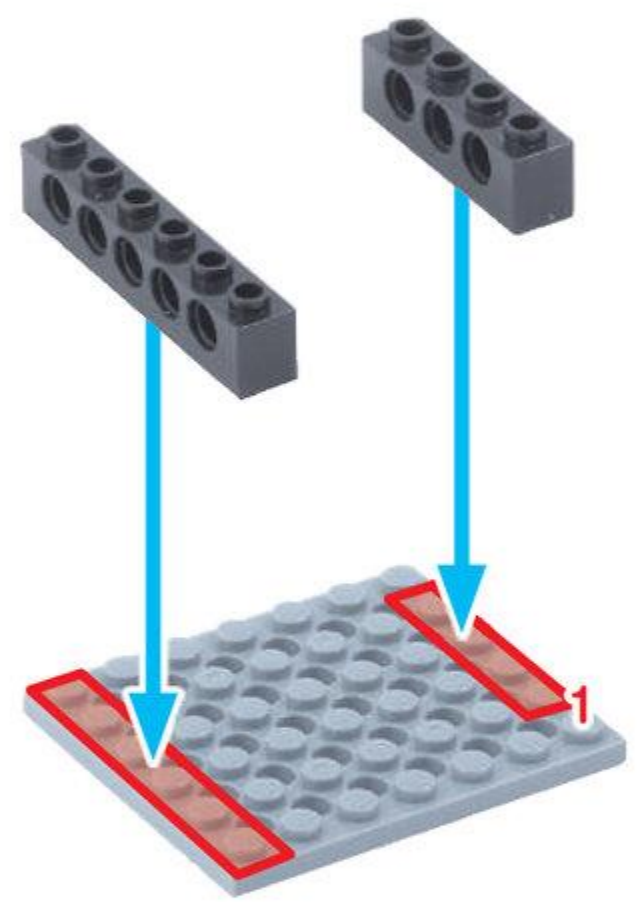

peg 2
peg S 2

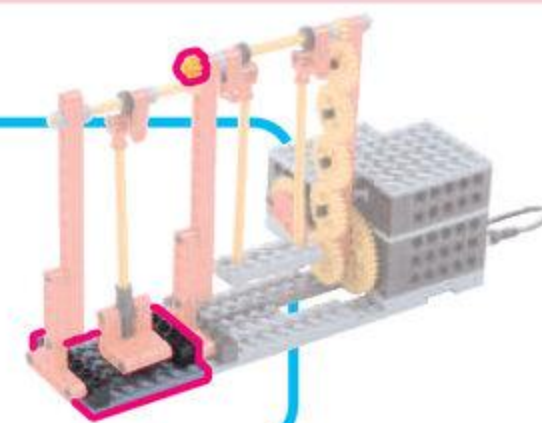

4

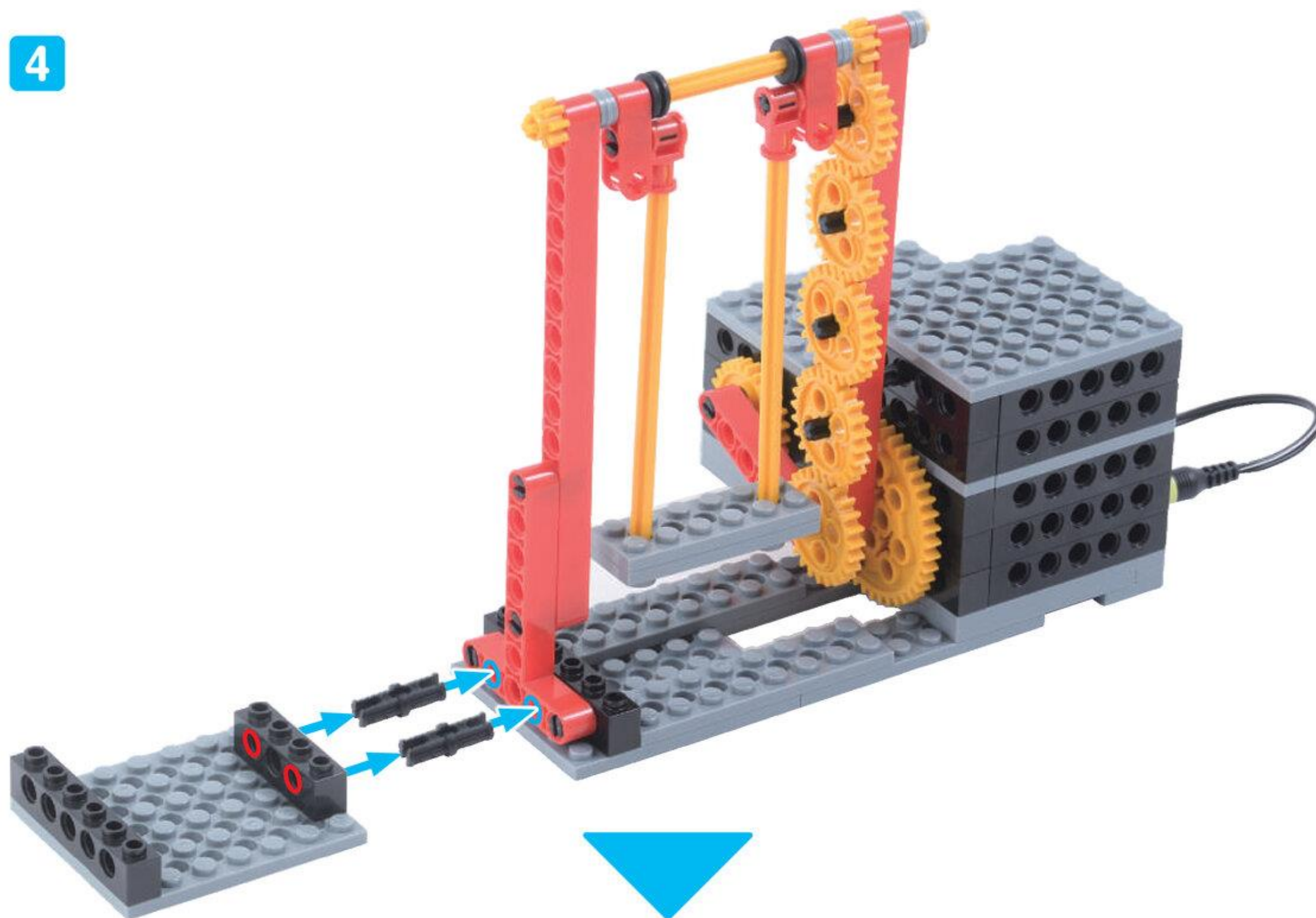

あたらしいじめんが
かんせい!



3 あたらしい ^{ぶらんこ} ブランコ めやす 15 ぶん

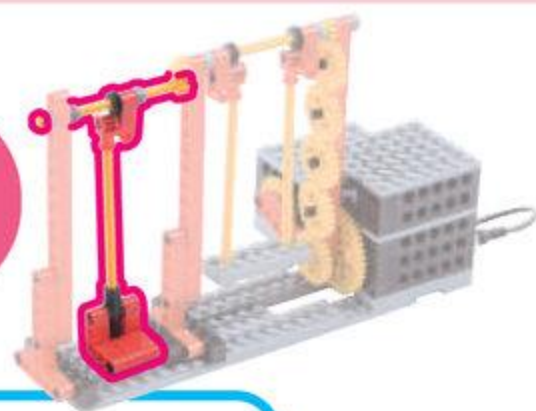

しやふと ^{じゅう} ぽち
シャフト **10** ぽち **1** こ





くろしやふと ^{いってん} ぽち
黒シャフト **1.5** ぽち **1** こ

ながさに
ちゅうい



くろすじょいんと
クロスジョイント **1** こ



○  みじかい

✕  ながい

あなしやふと ^{じょいんと}
アナシャフトジョイント **1** こ

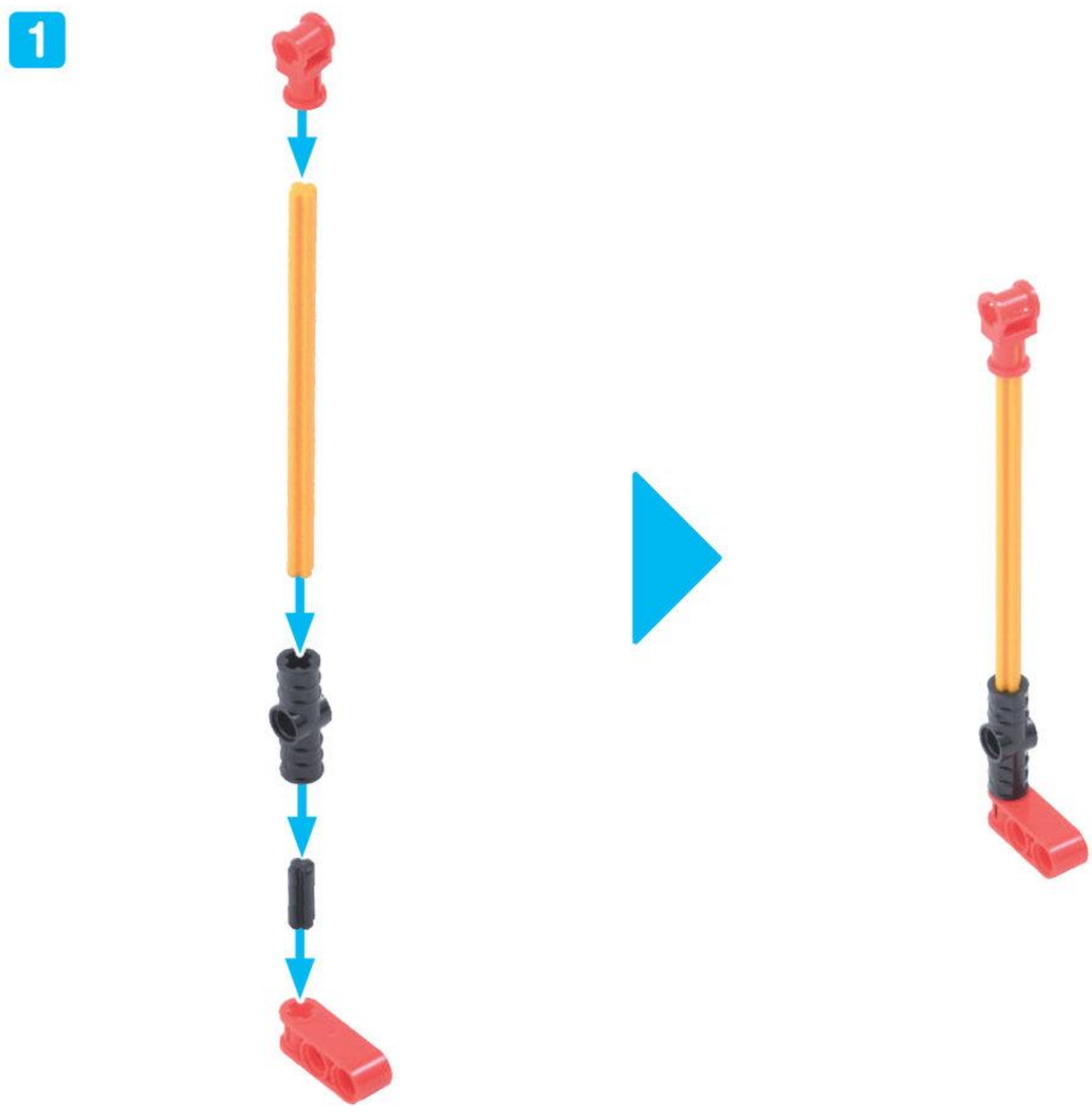

てい ^{じょいんと}
T ジョイント **1** こ

peg 2
peg 2



rod 2
rod 2

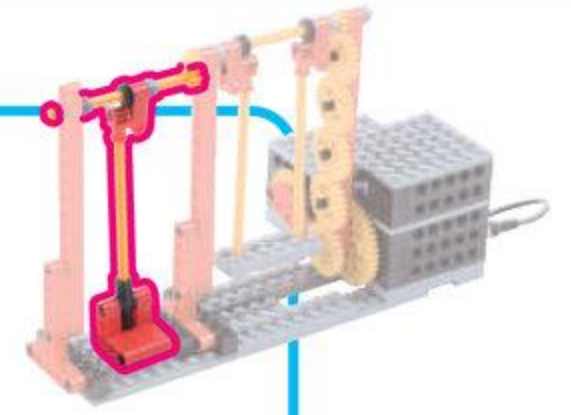

2

short side
long side



short side

long side

insert into this side

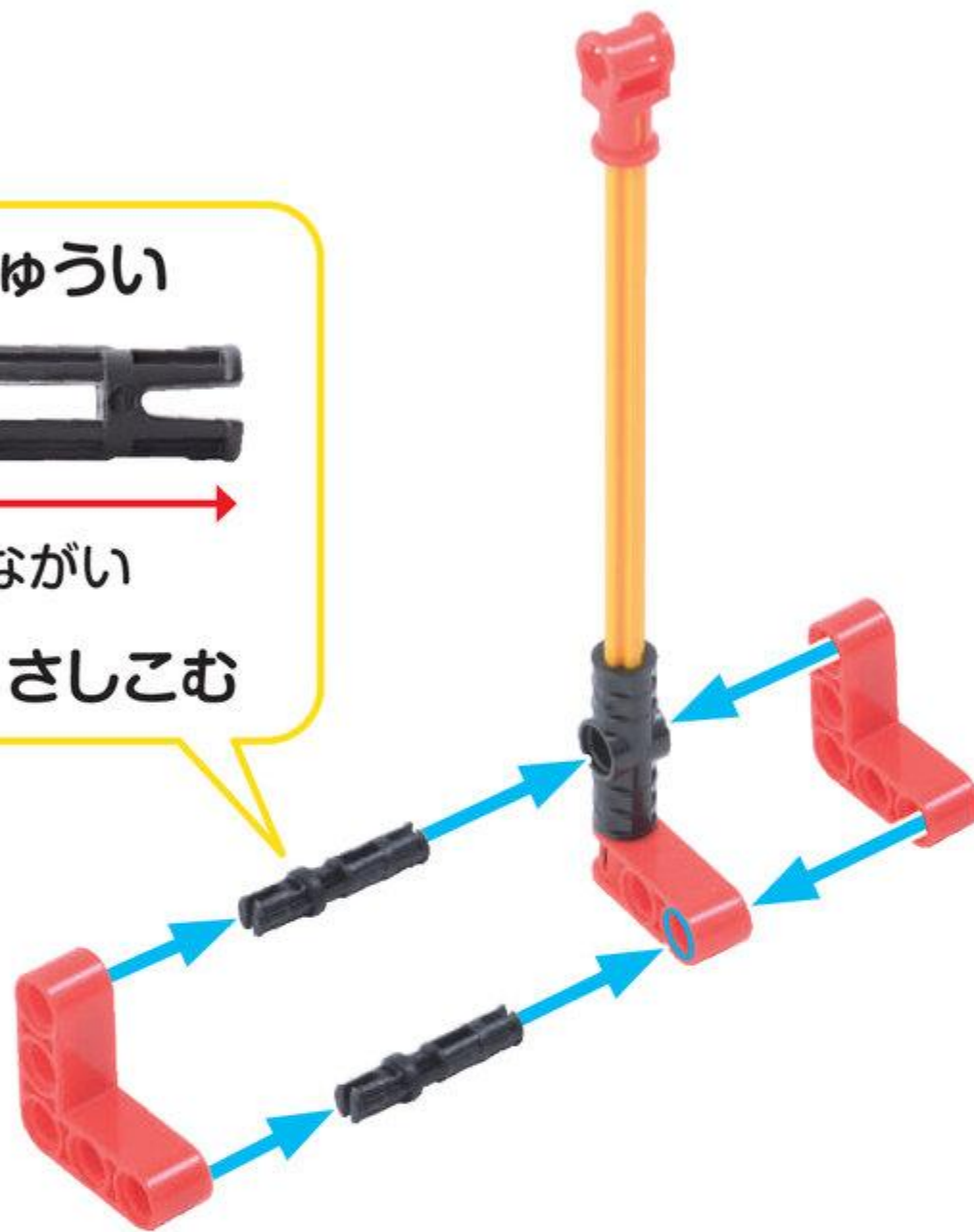

くるすじょいんと **1こ**
クロスジョイント



しゃふとペグ **1こ**
シャフトペグ

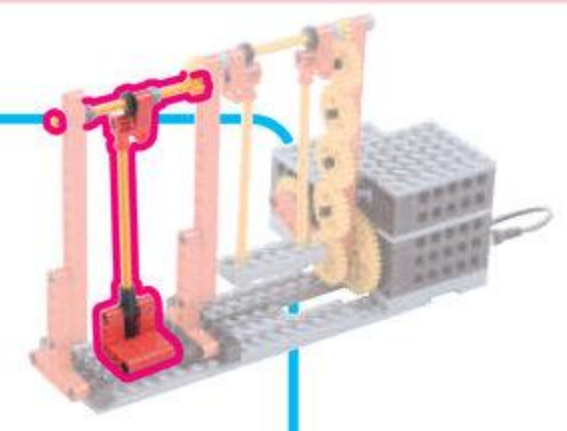
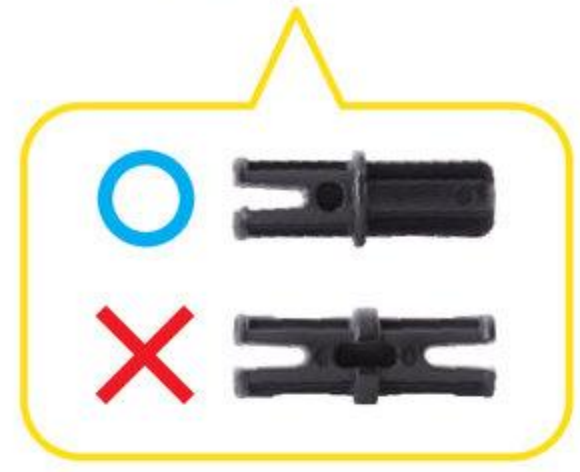

3

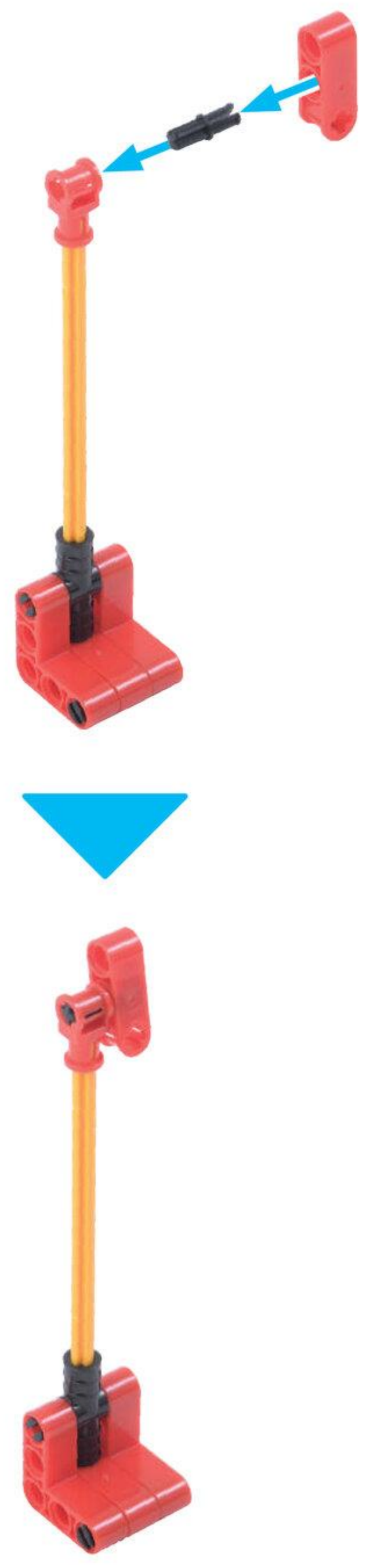

シャフトとじゅうぼち
シャフト 10 ポチ 1こ



ぴにおんぎあ
ピニオンギアうす 1こ



くろめつと
グロメット 1こ



ぶっしゅ
ブッシュ 2こ

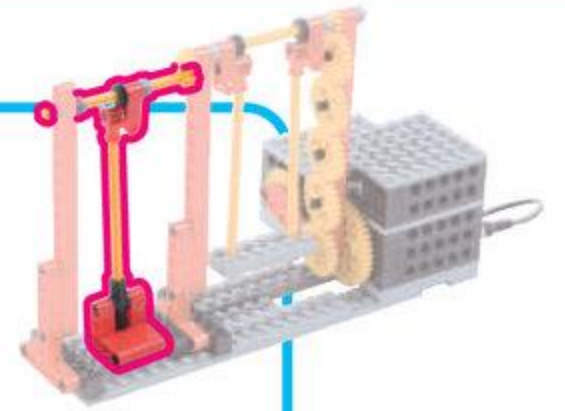

4

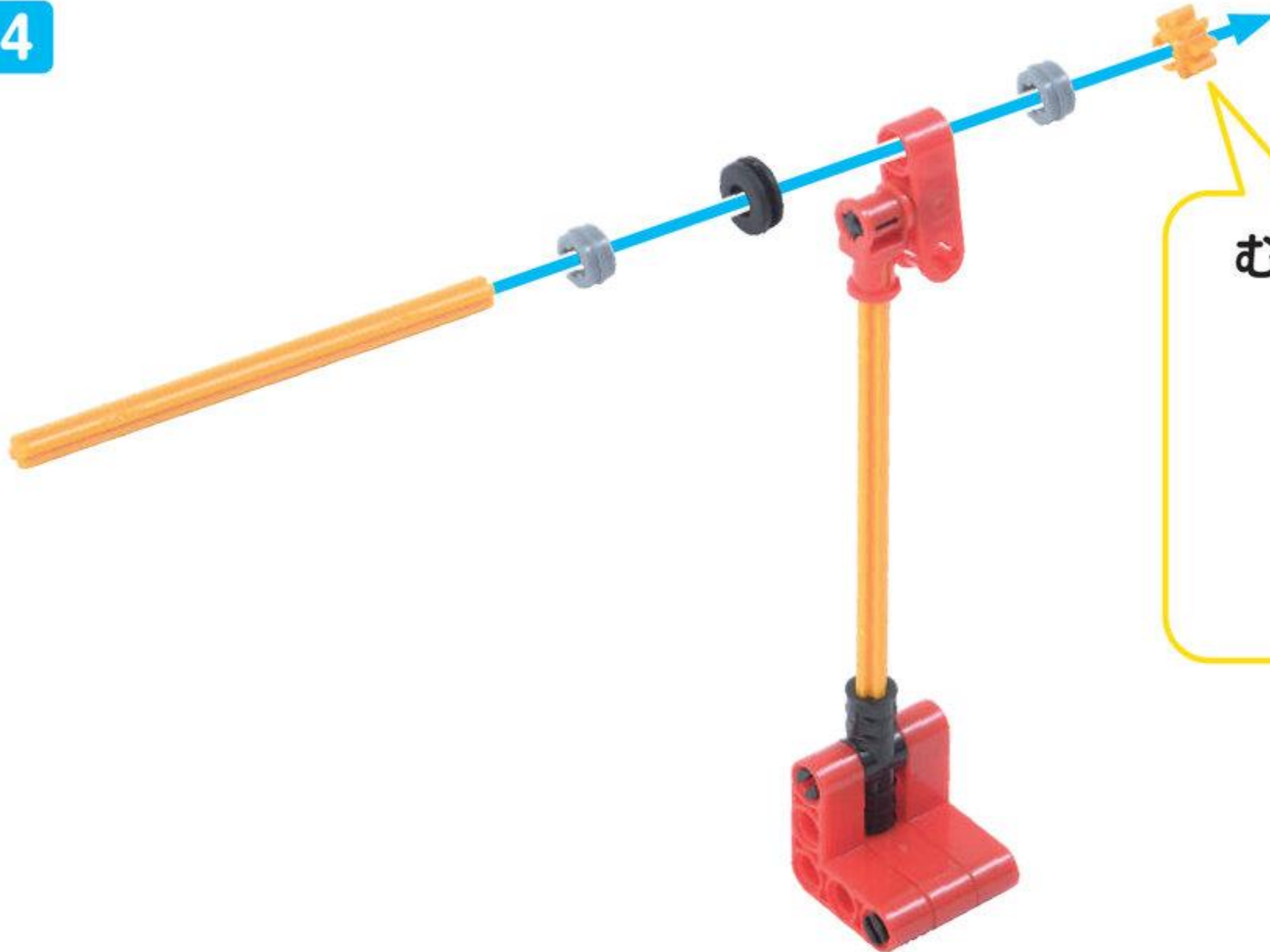

むきに ちゅうい



こちらを
さしこむ



5

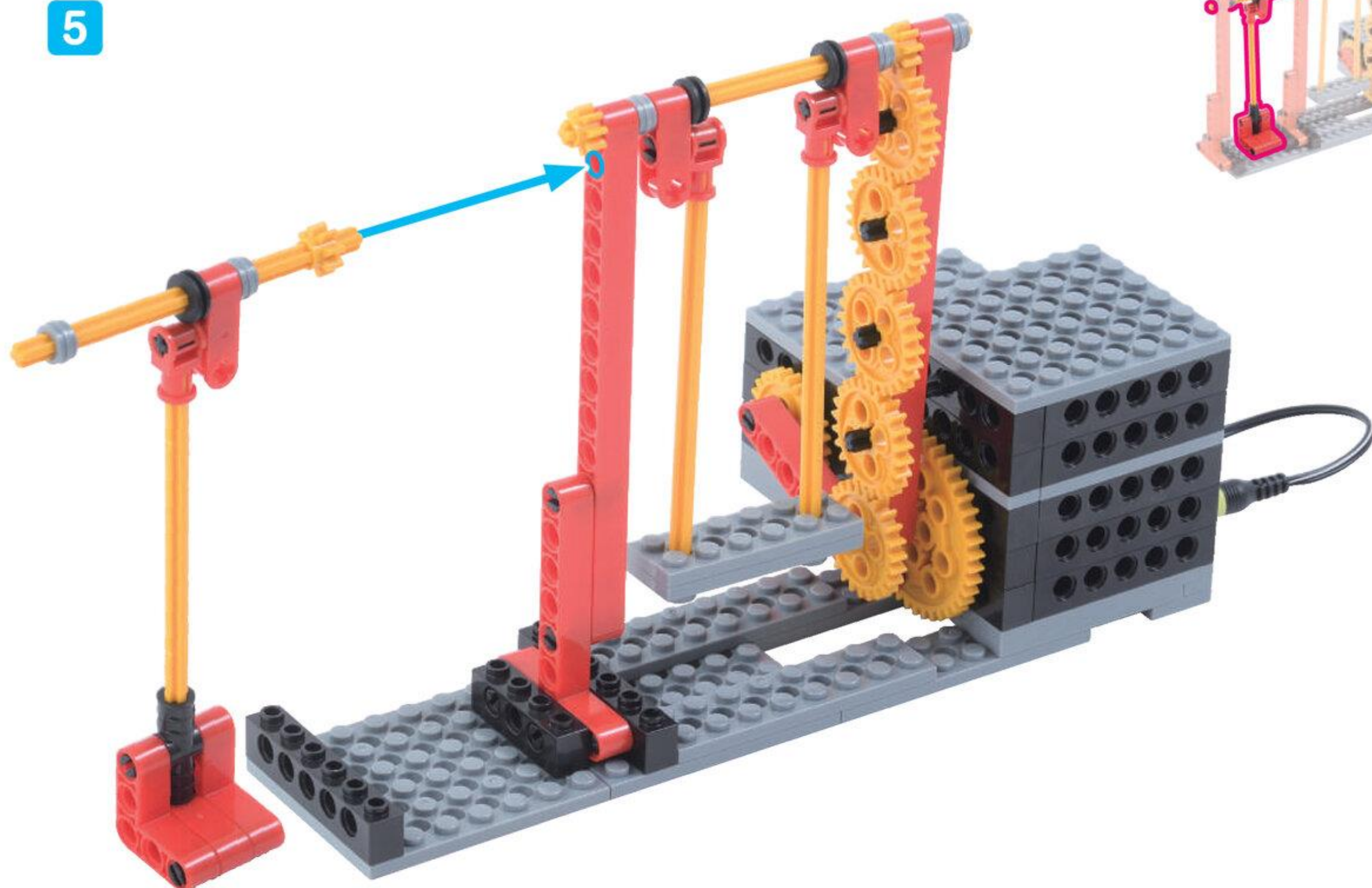

しっかり かみあわせよう

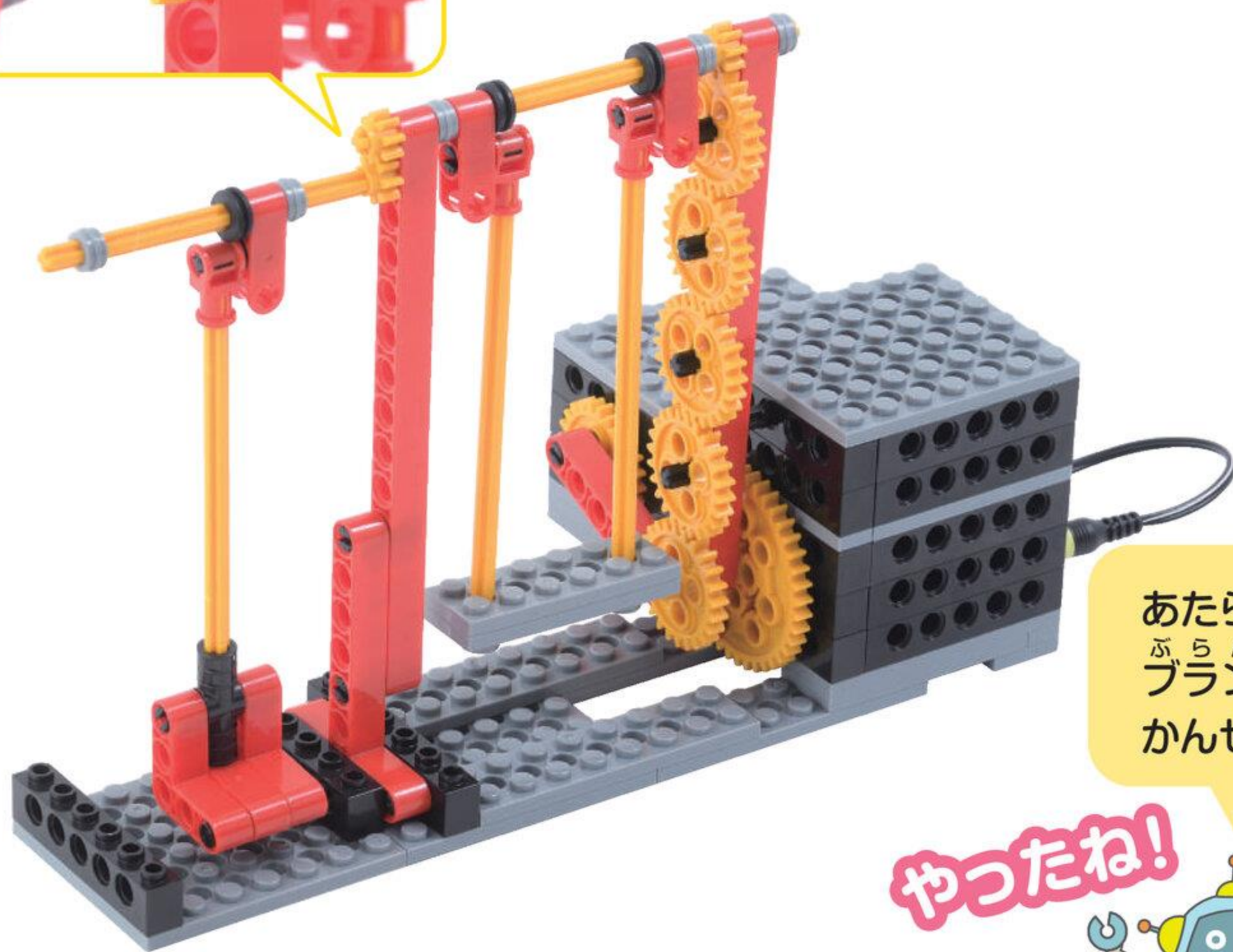

あたらしい
ぶらんこ
が
かんせい!

やったね!

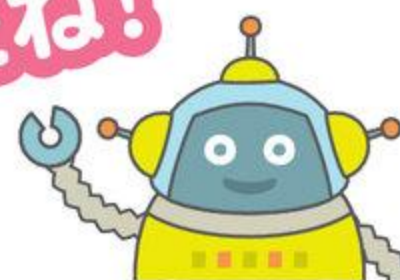

4 あたらしい はしら

めやす 5 ふん

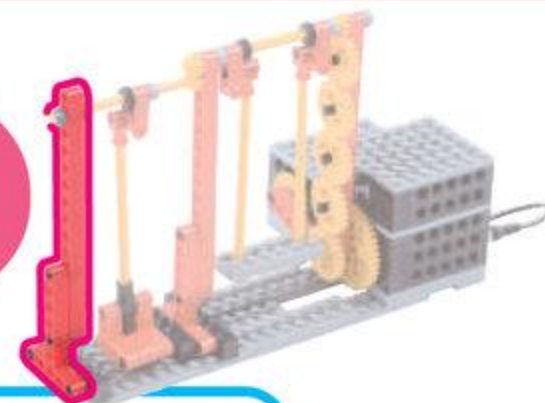

てい るっど
T ロッド 1こ

pegu su
ペグ S 4こ

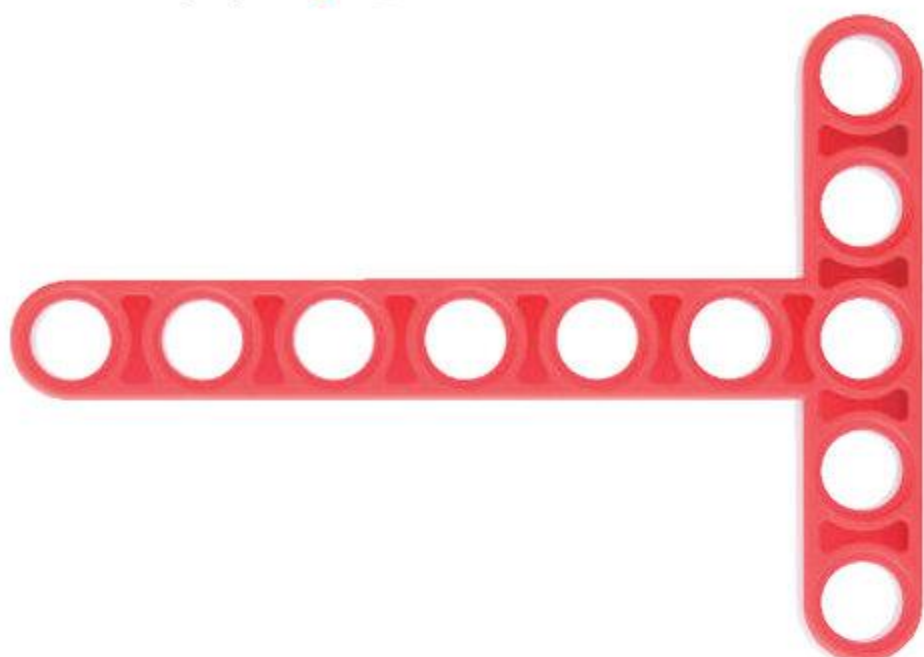

1

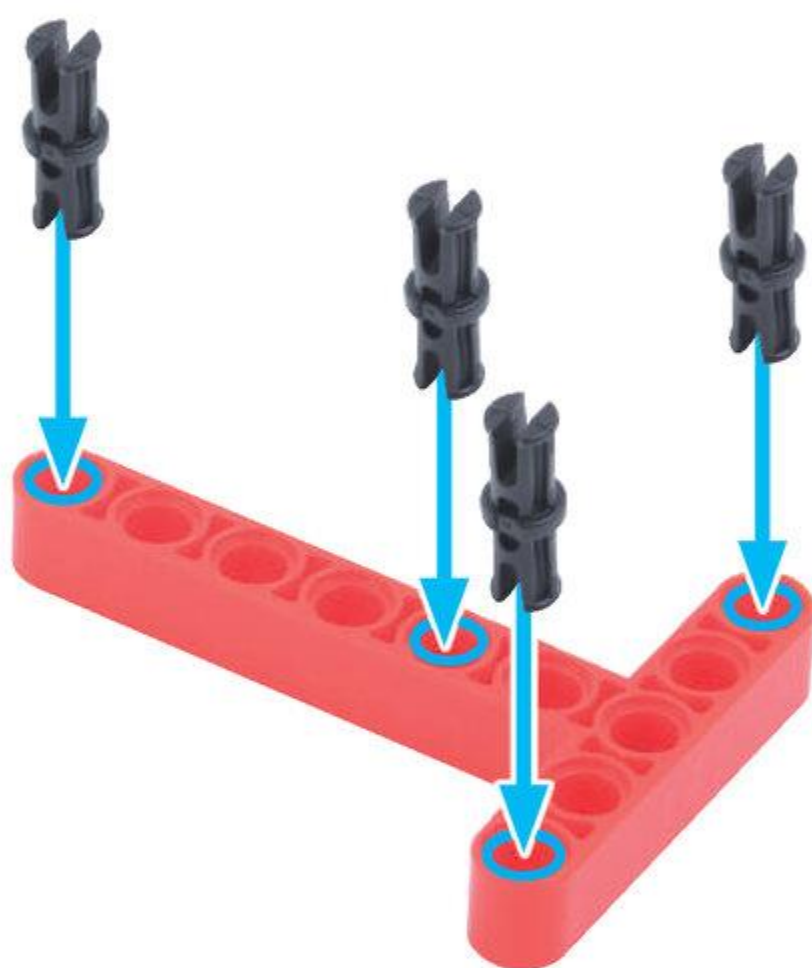

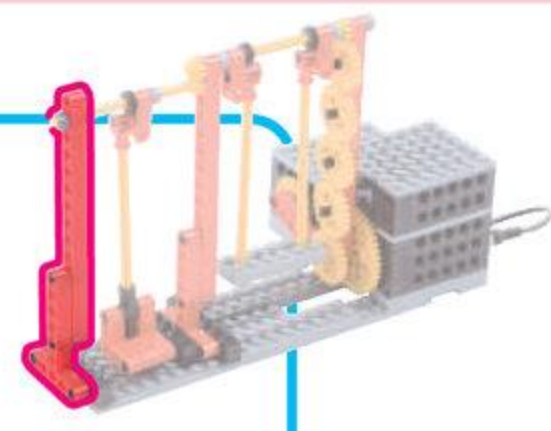

ろっど しゅうご あな **1**こ
ロッド 15 アナ



2

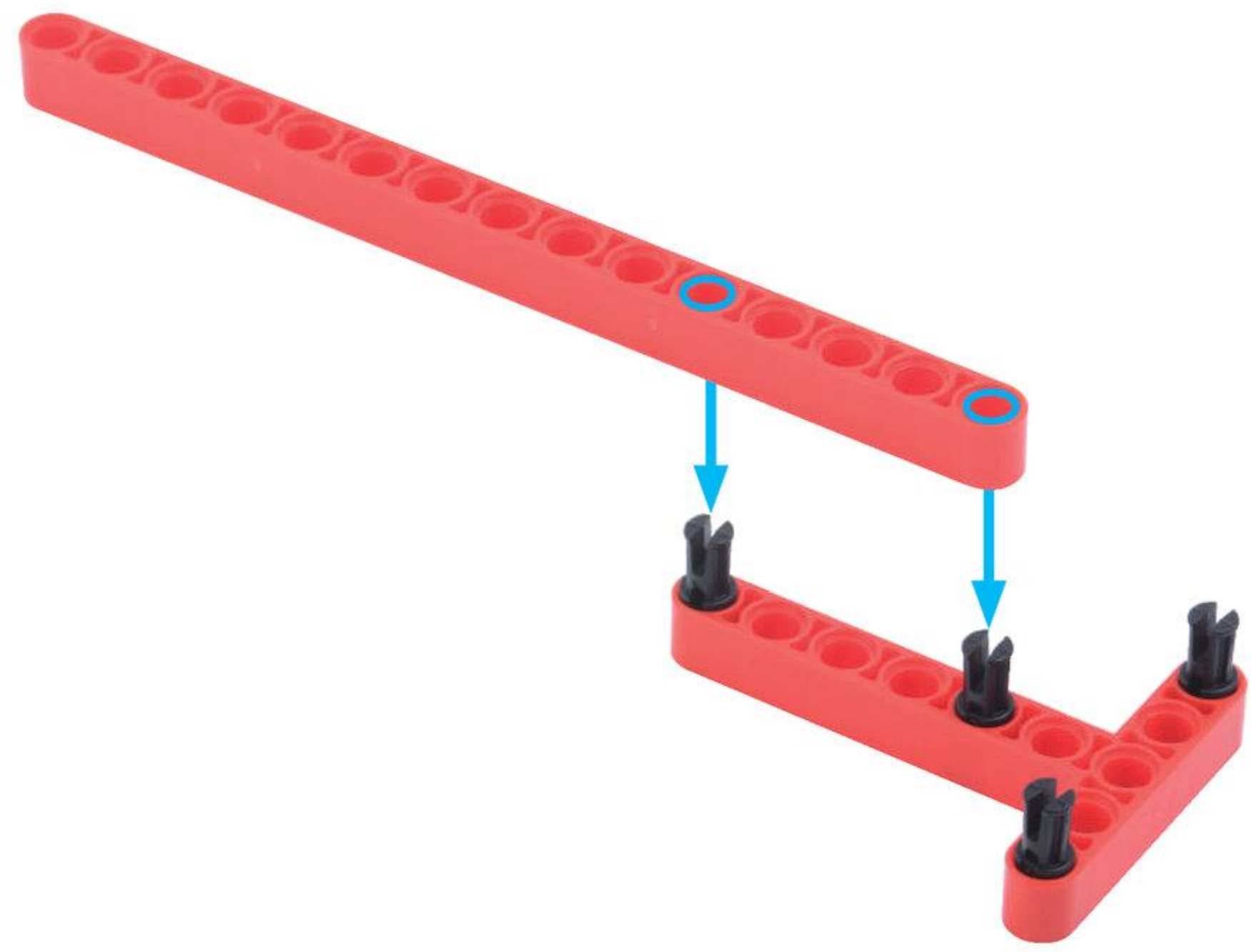

ぶっしゅ 1こ

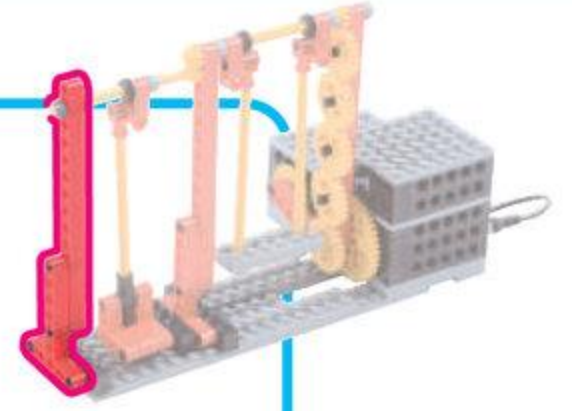

3

あな
アナの いちに
ちゅうい

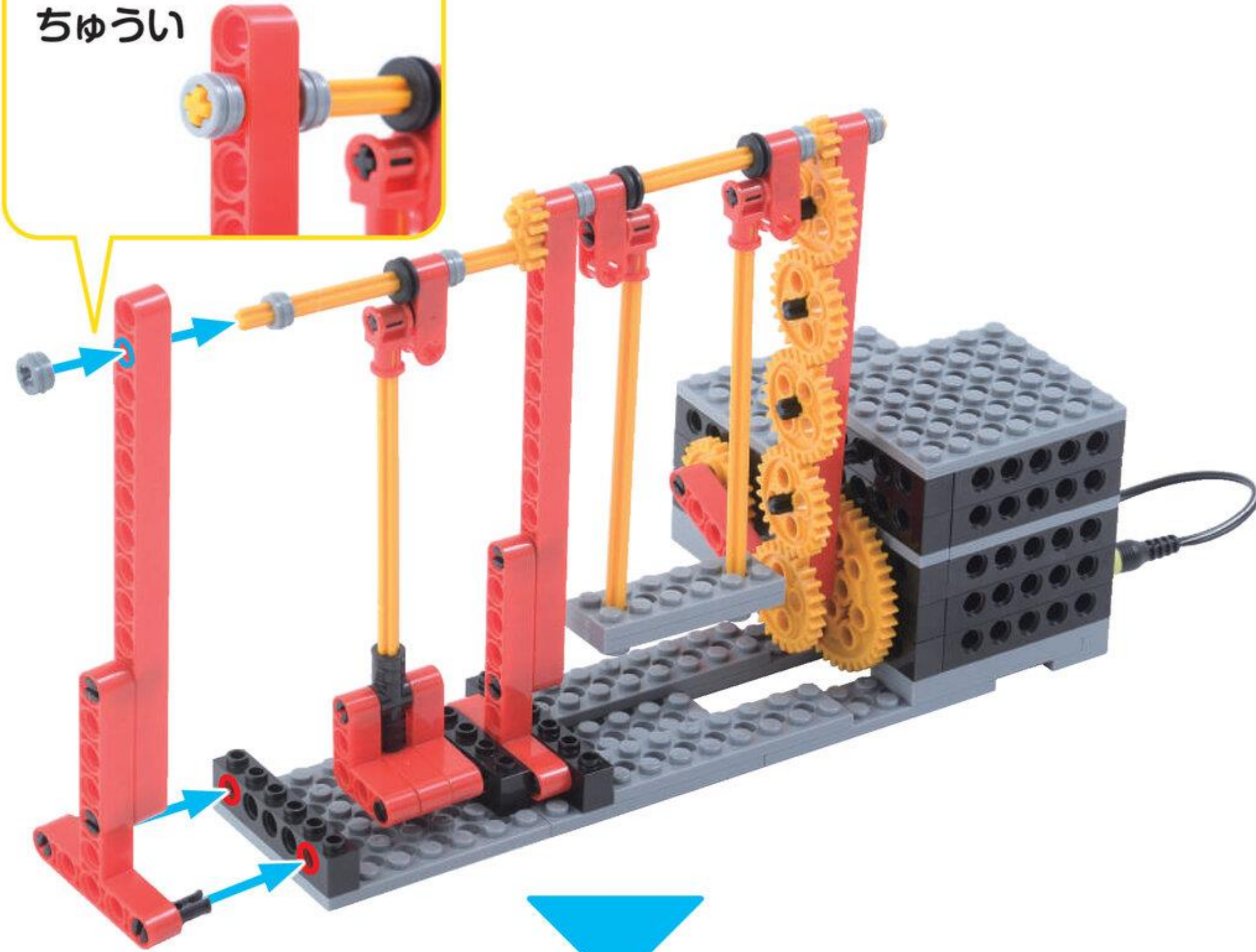

これで
かんせい!

よくできました!



ロボットをうごかそう

めやす 15 ぶん

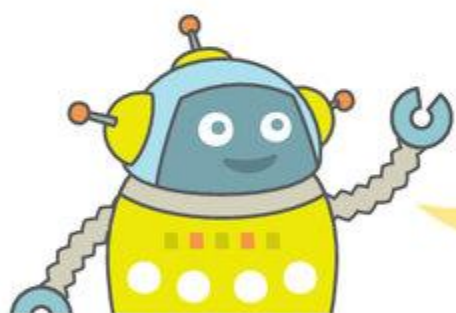
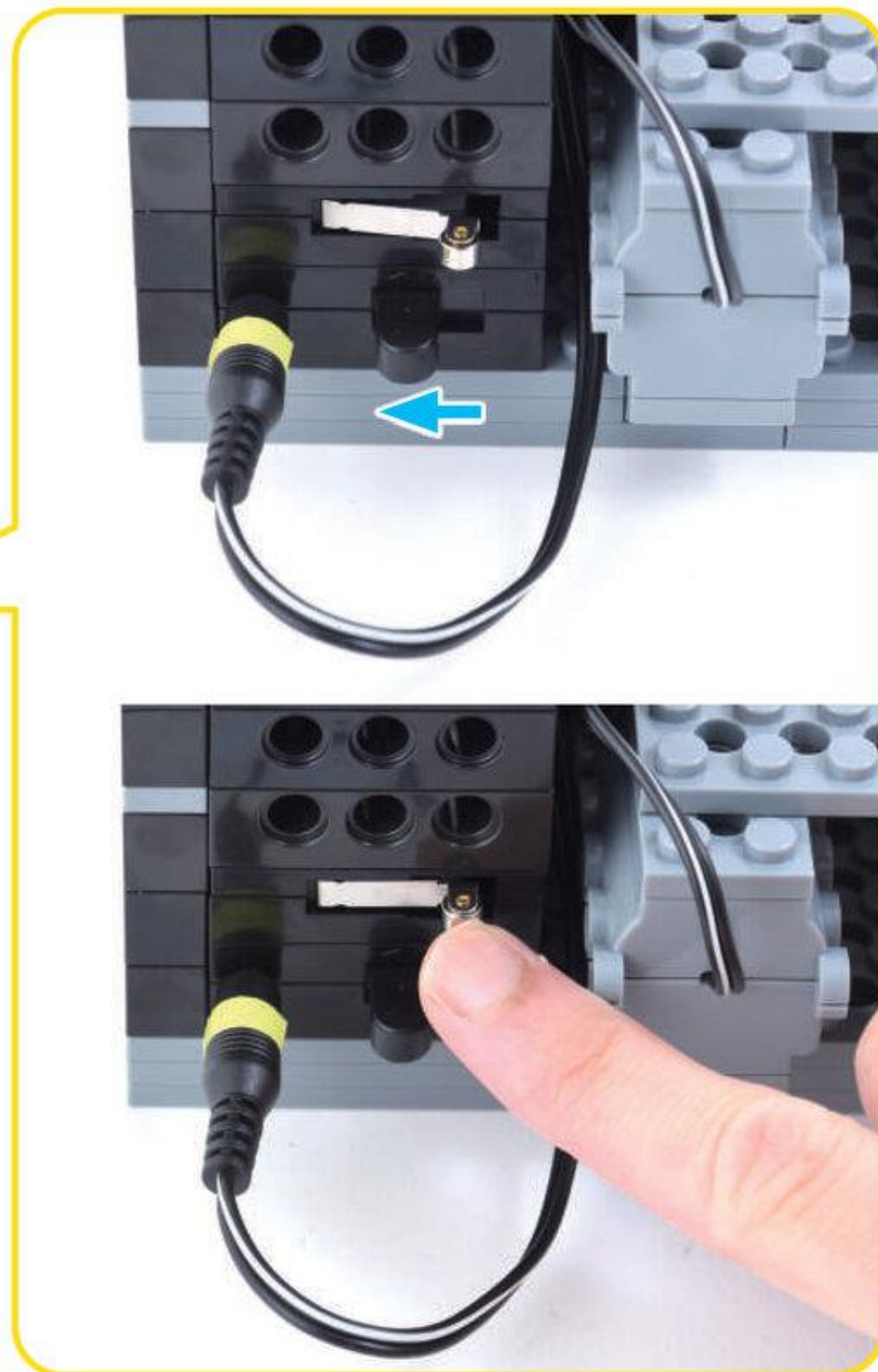
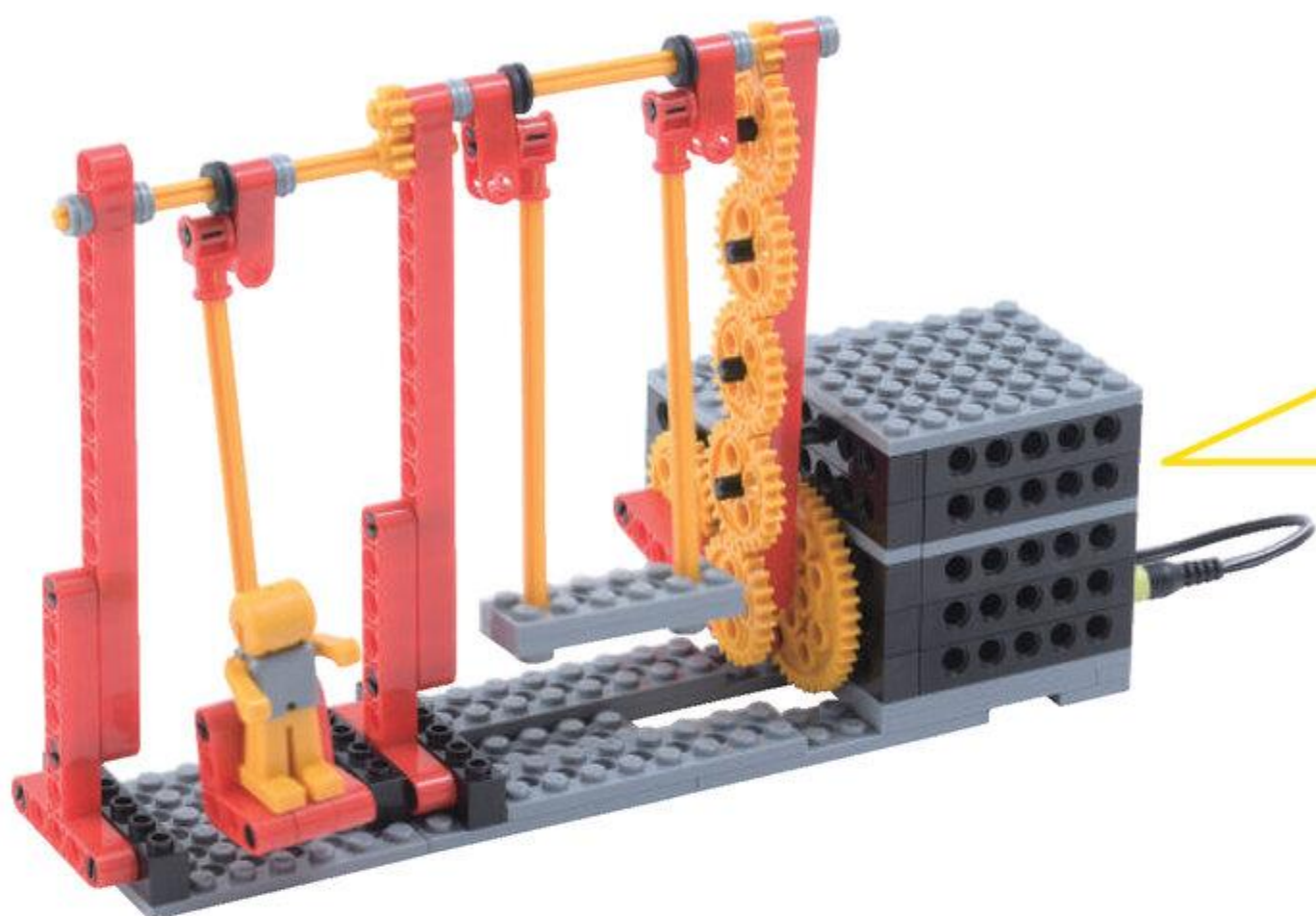

やじるしのむきに ^{すい} ^ち スイッチをいれて
た ^あ ^ち ^せ ^ん ^さ ^あ タッチセンサーをおしてみよう!



じゆうにかいぞうしてみよう

めやす 10 ぶん

ばあつ
パーツをつかって、じゆうにかいぞうしてみよう！

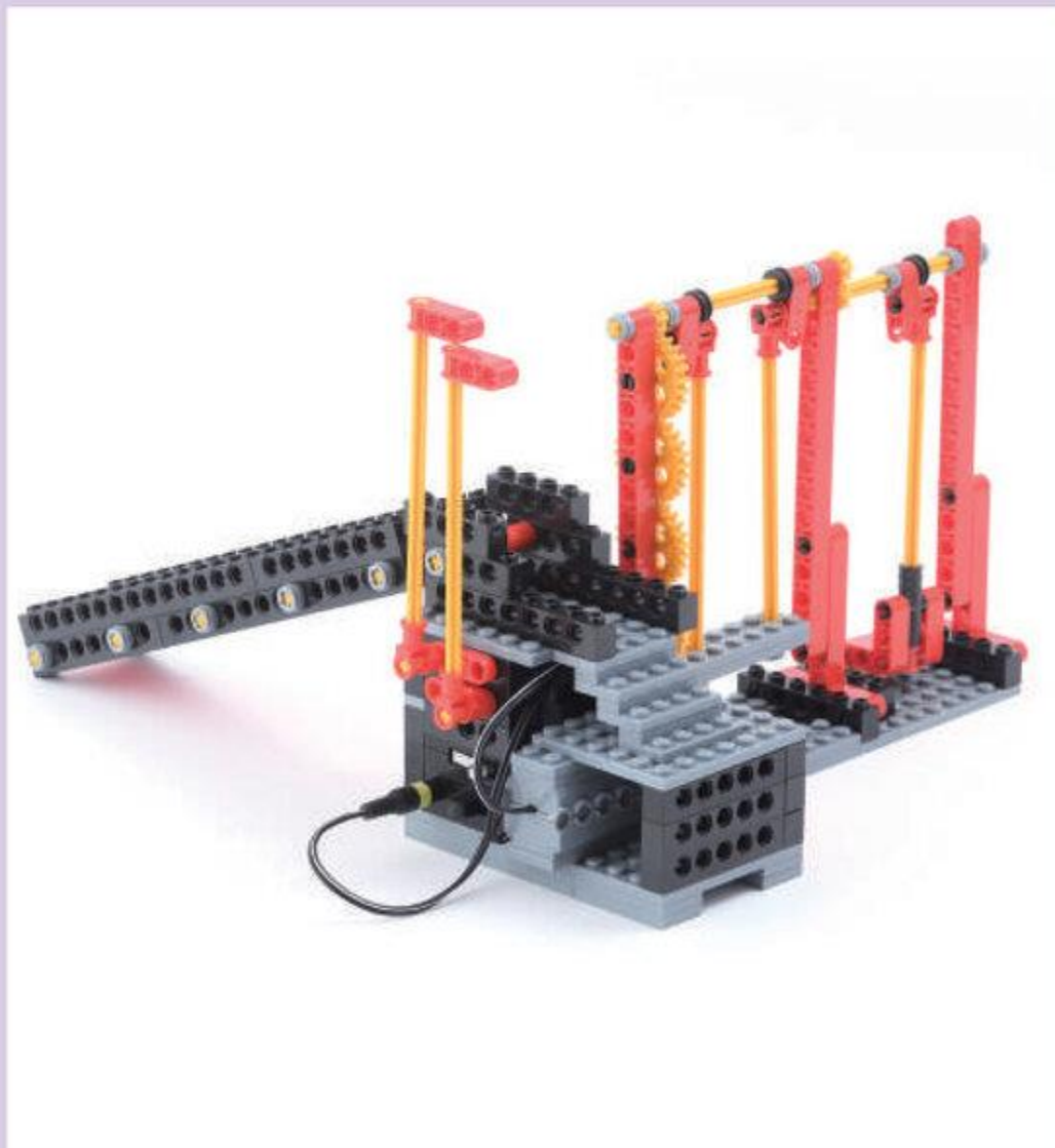
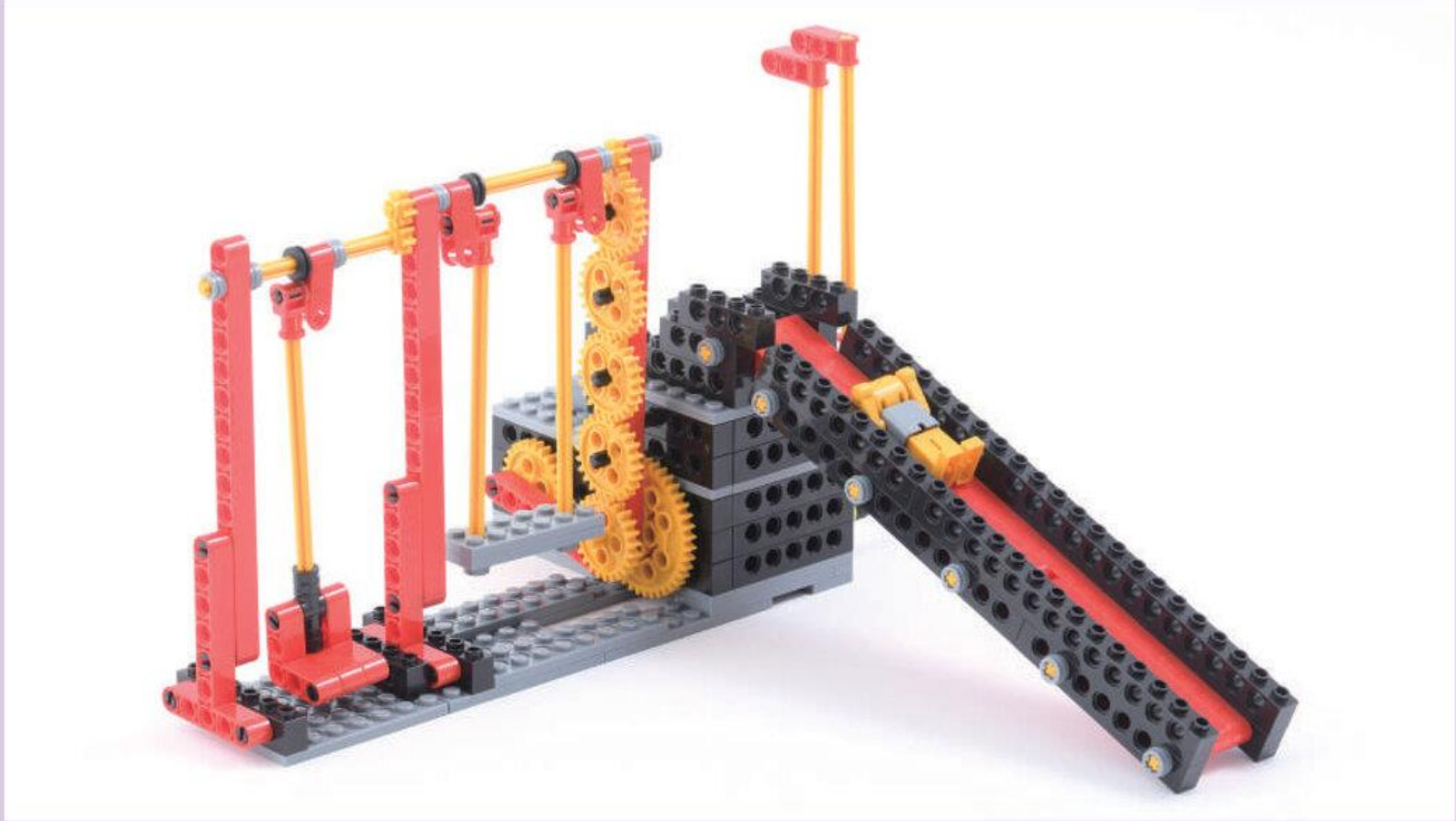

たのしく あそべるように しよう！

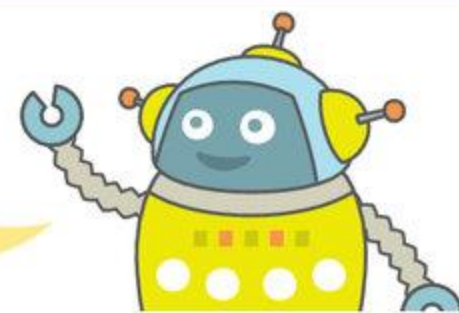

まちがいさがし

めやす 3 ぶん

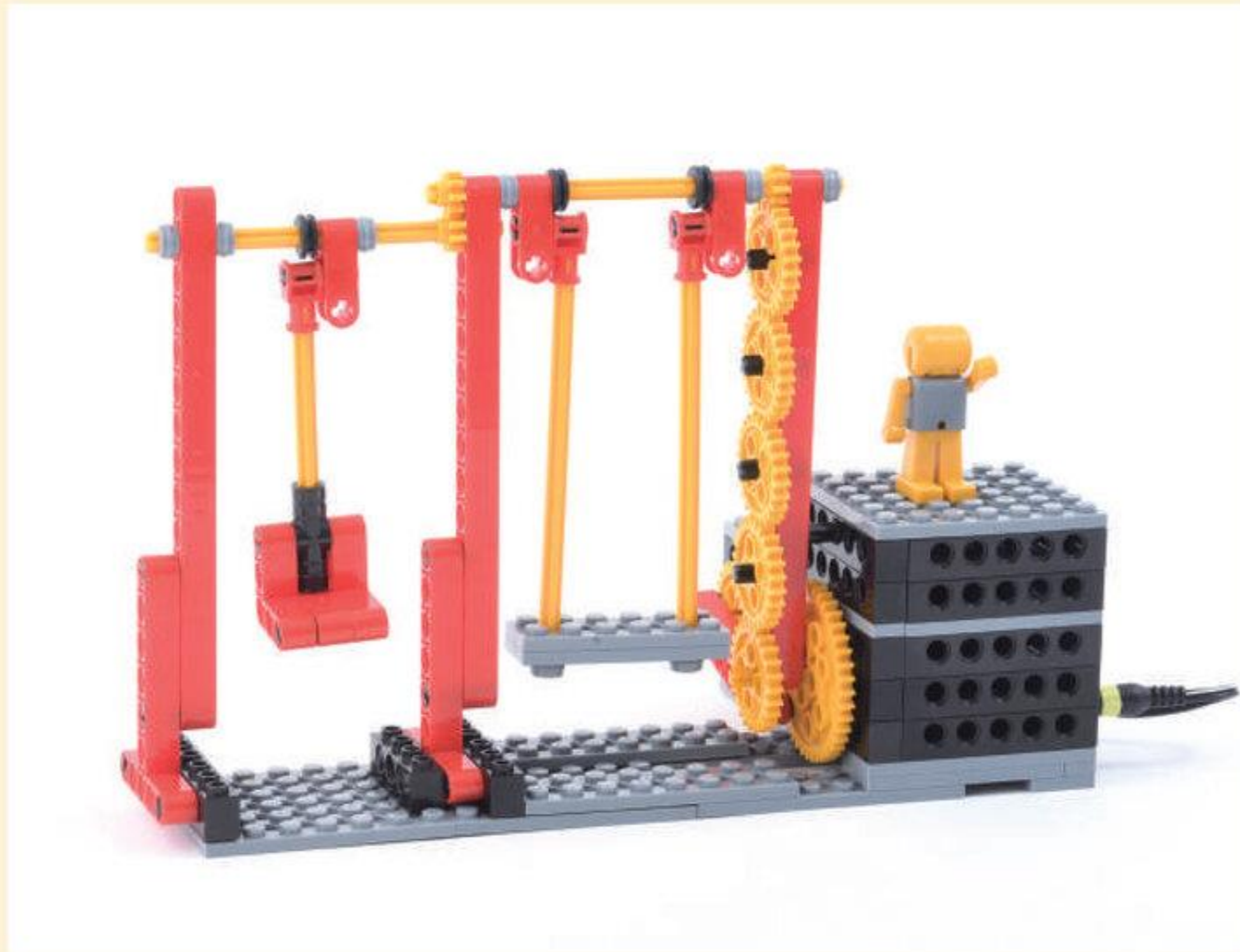

ちがうところを みつけよう
2つあるよ!

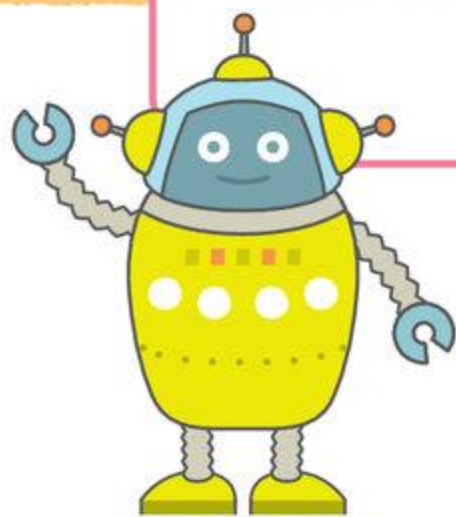

じかいの ろぼっと

じかいつくる^{ろぼっと}ロボットは
はいたつ^{ろぼっと}ロボット
「^もつて^くて^く」

ものを はこびながら
まえに すすむ^{ろぼっと}ロボットだよ

