



Human

ヒューマンアカデミー ジュニア
STEAMスクール



ロボット教室

ロボットのきょうかしよ

プレプライマリーコースⅡ

1

のってはして「キックボ^きー^くボ^ほー^おー^だダー^あ」



★だい1かい

2023 ねん

4 がつ

にち

なまえ

ちゅうい しょう

ばあっ パーツや でんきぶひんを あんぜんにつかうために

! ばあっ パーツを くちに いれない

くみたてた ばあっ パーツを とりはずすときは、
ぜったいにはをつかてはいけません。
ばあっ パーツを のみこんでは いけません。

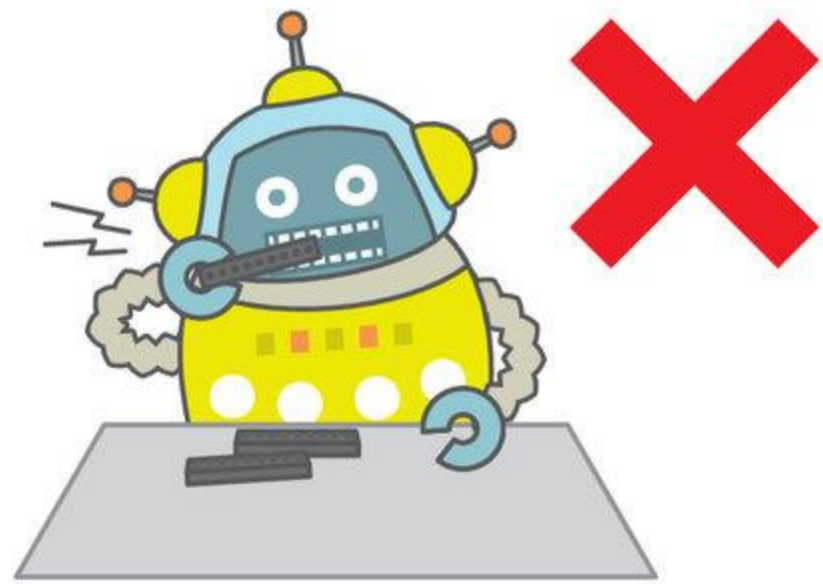

! ぶひんを きずつけない

でんきぶひんを はさみや かつたあ カッターなどで
きずついたり、ばあっ パーツで はさんだりしては
いけません (しゃしん 1)。

こおど や けえぶる コードや ケーブルは、おりまげたり、
ひっぱったりしては いけません。

ぶらぐ の むきさしは、ぶらぐぶぶんを
もって おこないましょう (しゃしん 2)。

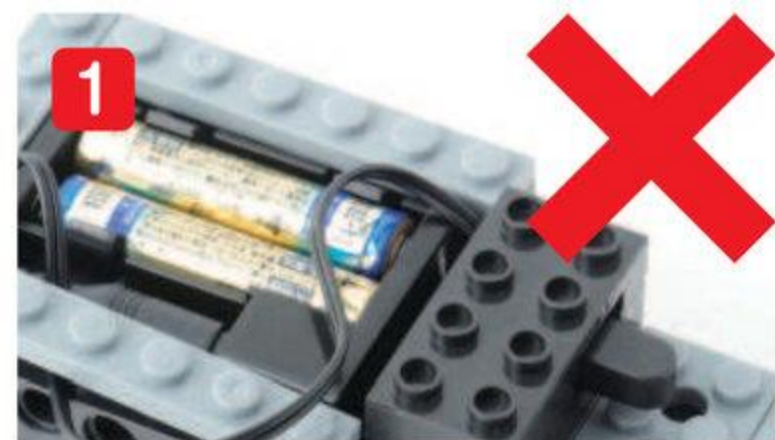

! あつい・におうとき、へんなおとが するとき

ろほっと ロボットを うごかしたときに、でんちや でんきぶひんが
あつくなったり、へんな においが したり、いつもと ちがうおとが
したばあいは、すぐに ロボットを とめ、せんせいに しらせましょう。
ぬれたてで でんきぶひんを さわってはいけません。

もくじ

だい 1 かい

ロボット <small>ろぼっと</small> のふんかい	3	10ふん
かんがえてみよう	3~4	12ふん
きょうの <small>ぱあつ</small> パーツ	5	
きょうのよてい	6	
くみたて 1. ボード <small>ほおど</small>	7~26	
ロボット <small>ろぼっと</small> をうごかそう	27	60ふん
くみたて 2. ハンドル <small>はんどる</small>	28~34	
3. ストッパー <small>すとっぱあ</small>	35~38	
4. ぜんりん	39~41	
ロボット <small>ろぼっと</small> をうごかそう	42~43	
クイズ <small>くいず</small>	44	
かたづけ		5ふん

ふるっく
ブロックはずし



つかうとべんりだよ

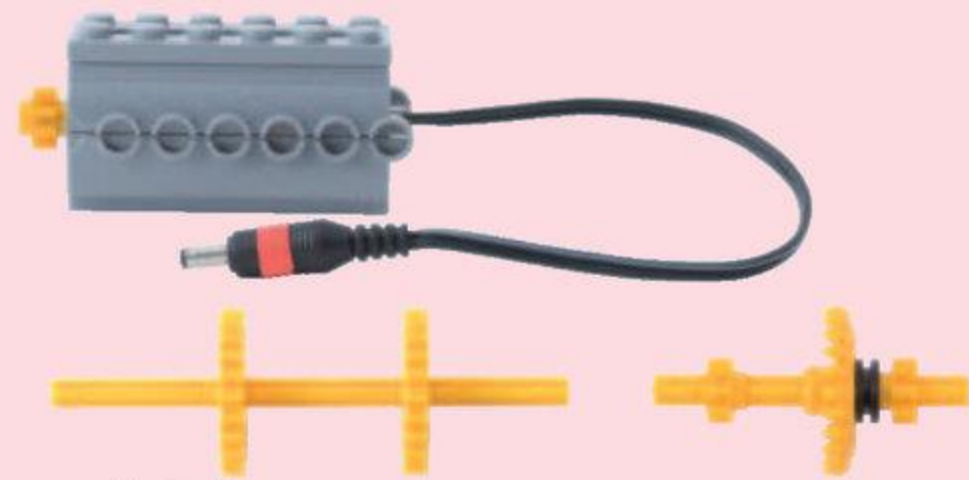

このセットせっとはくずさないでね! またつかうよ



かんがえてみよう

めやす 5ふん



キックボードきっくほおどを

みたことが

あるかな?

どんなかたちを

していたかな?



き っ く ほ お ど は す け え と ほ お ど に
キックボードは スケートボードに
は ん ど る が つ い た の り も の だ ね

す け え と ほ お ど
スケートボード



と

は ん ど る
ハンドル



が

が っ た い し て

き っ く ほ お ど
キックボード



に な っ た よ !

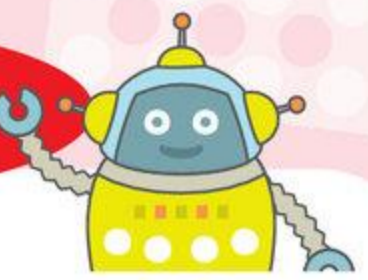

めやす 5 ふん

いろいろな ぎあ ギア

パーツを ばあつ みつけよう

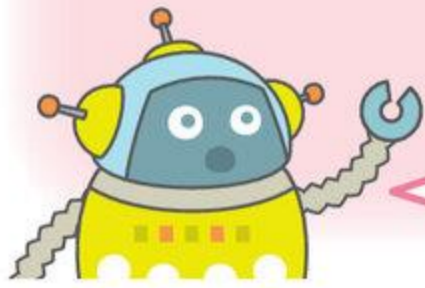

いろいろな おおきさがあるね

まず たあ マスターしよう

まんなかの しゃふと あなに シャフトのかたちをした ばあつ パーツを させるよ

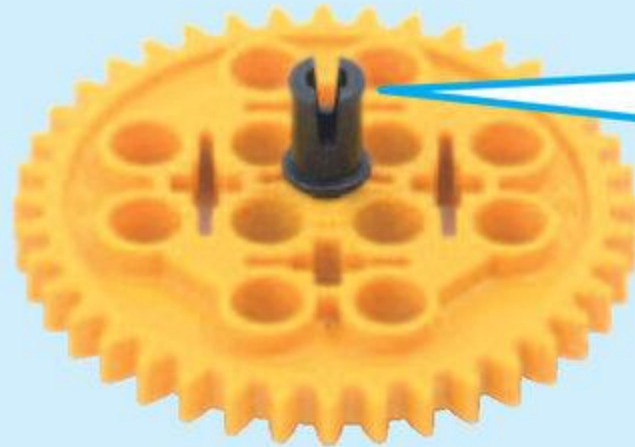

しゃふと シャフトペグ



びいむ ビームにとりつけるとくるくるまわせるよ!

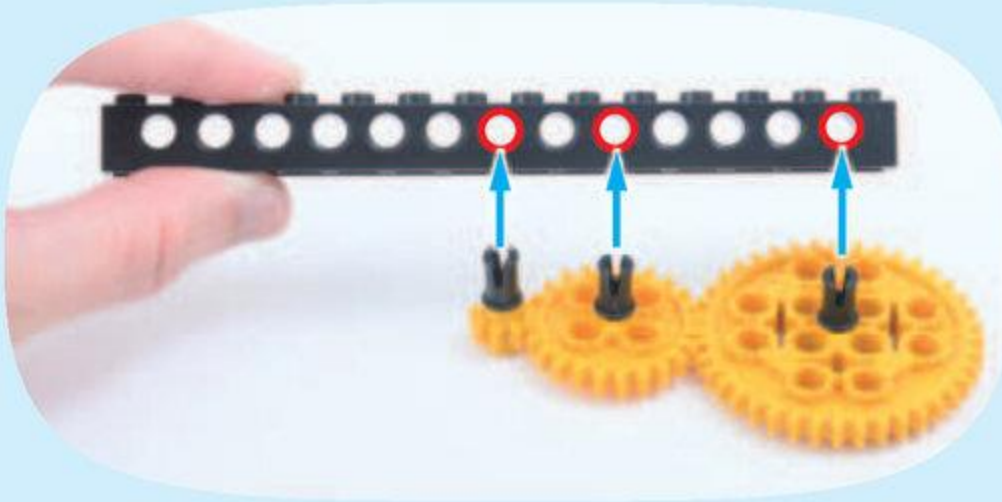

となりの ぎあ ギアにも
うごきがつたわるよ!

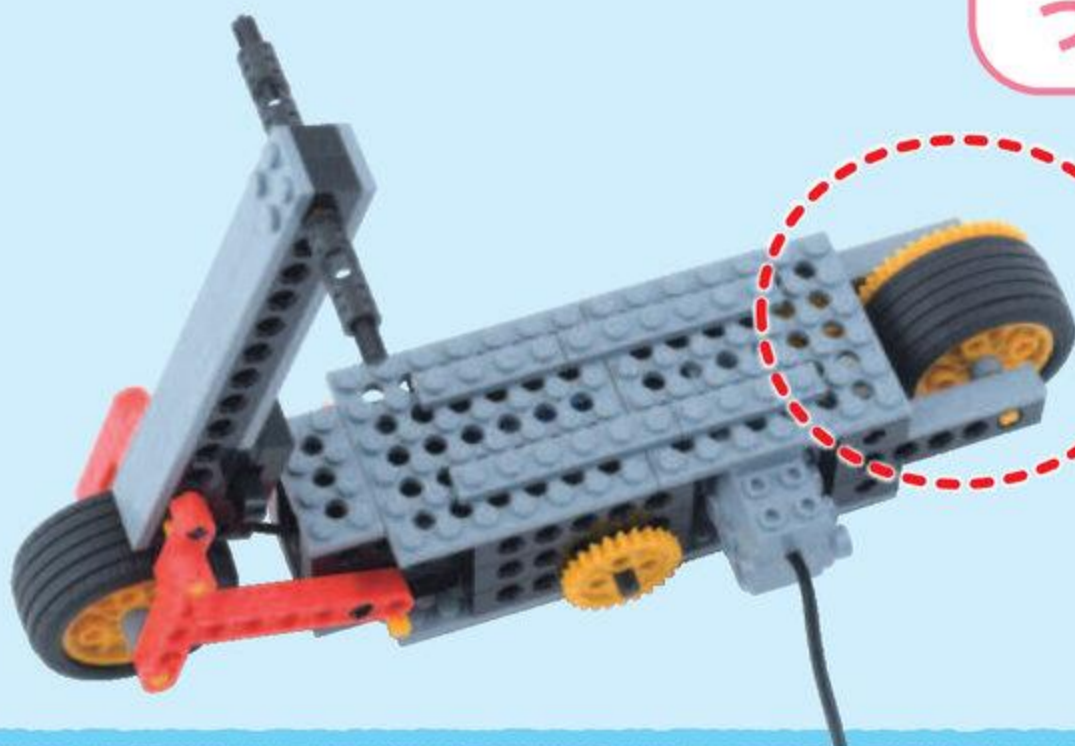

ここで つかうよ つかうよ



きょうの よてい

めやす 2 ふん

このじゅんばんでつくるよ!

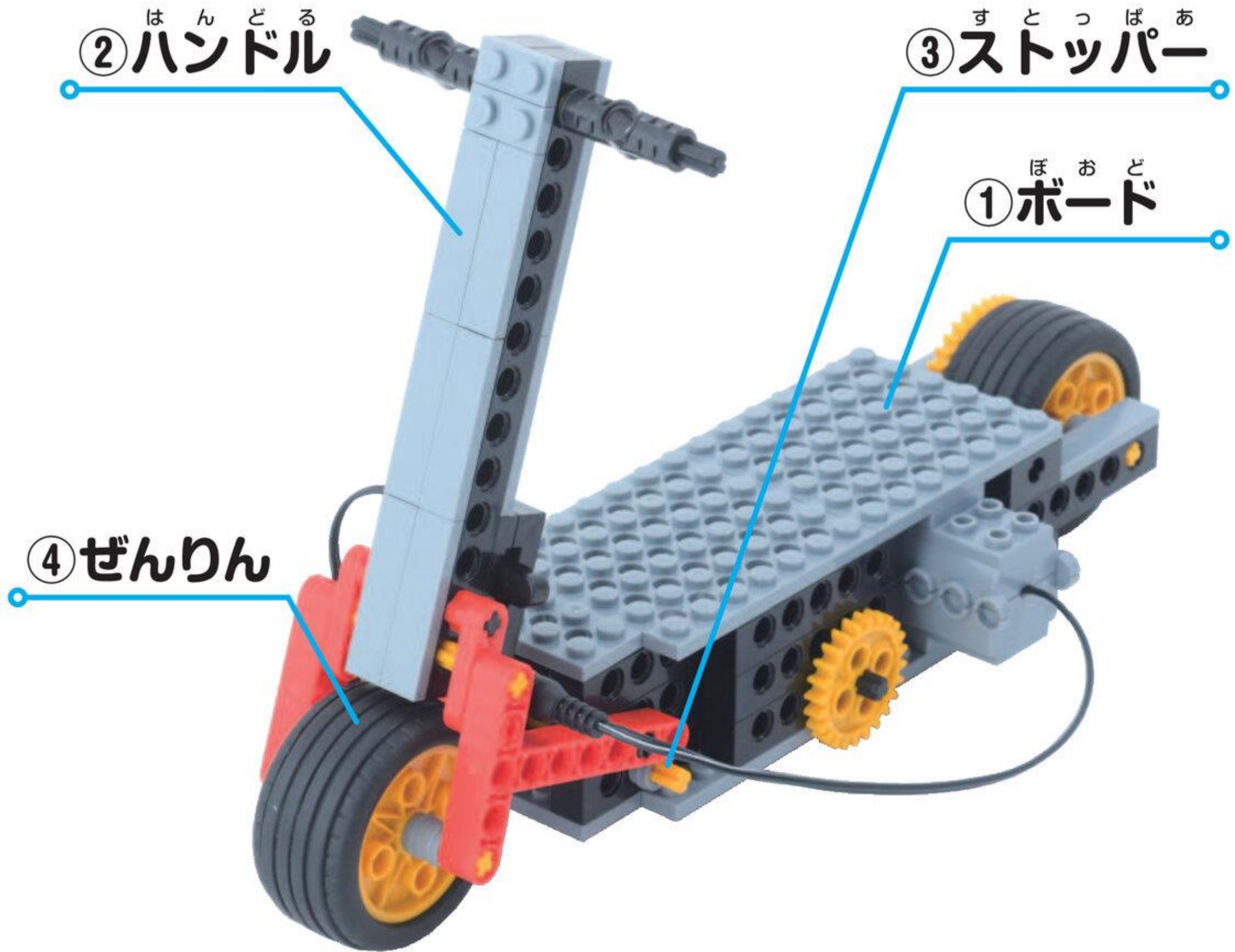

① ボード



② ハンドル



③ ストッパー



④ ぜんりん

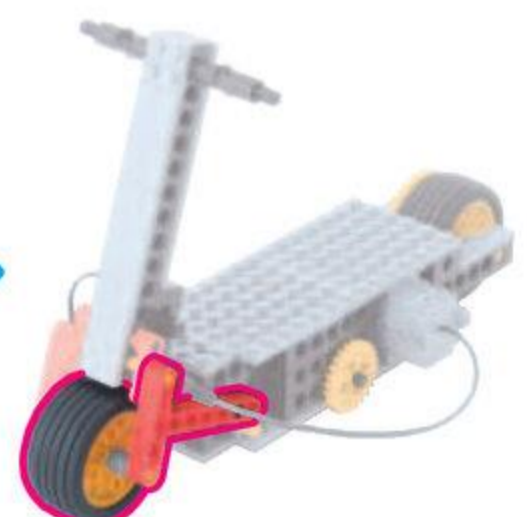

1

ほ お ど
ボード

めやす 30 ぶん

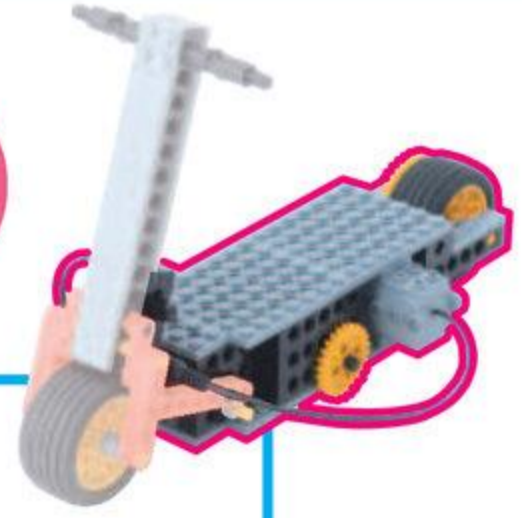

びいむ はち ぼち
ビーム 8 ポチ 1 こ



びいむ よん ぼち
ビーム 4 ポチ 1 こ



たいる
タイル 1 こ



びいむ じゅうよん ぼち
ビーム 14 ポチ 1 こ



びいむ に ぼち
ビーム 2 ポチ 1 こ



1

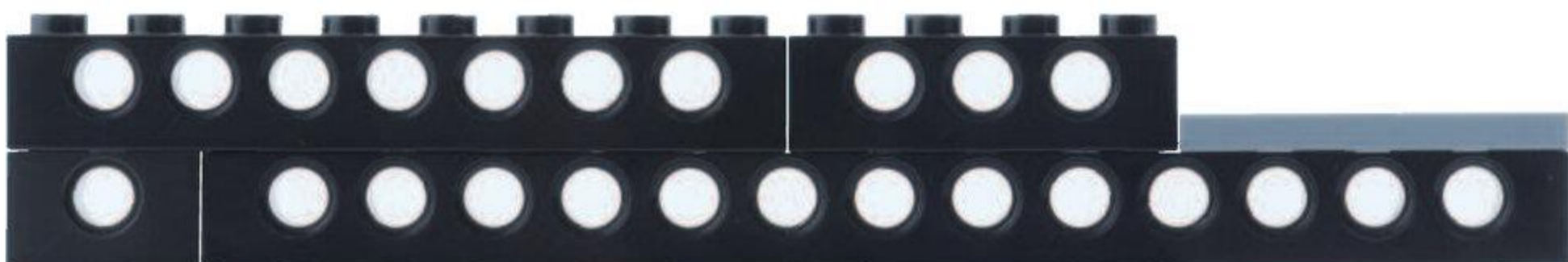
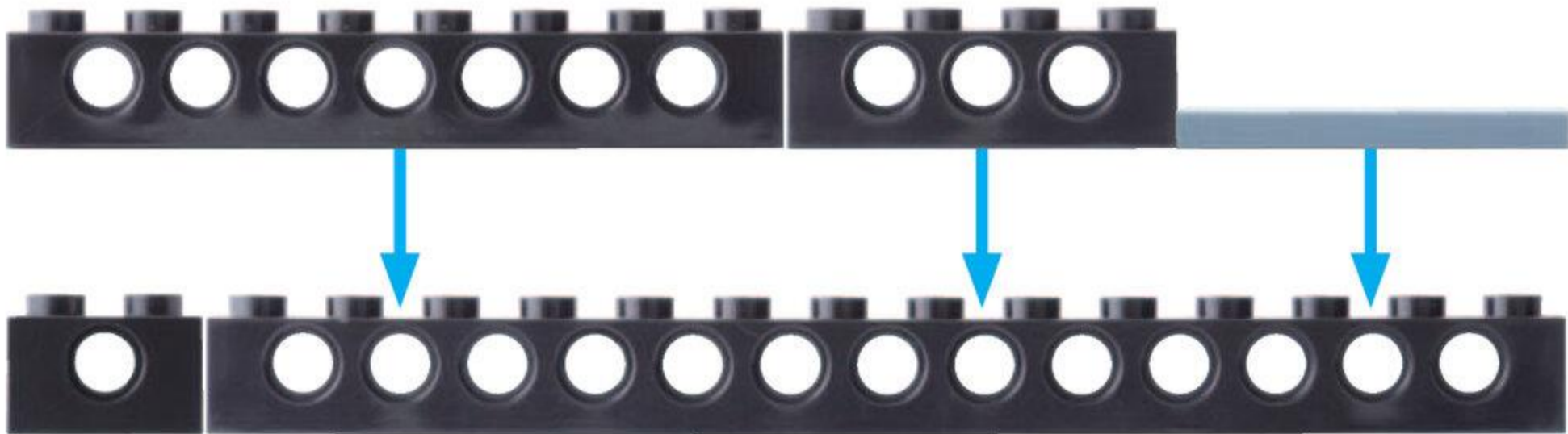

1 プレプライマリーコース 4がつ

びいむはちほち
ビーム 8 ポチ 1こ



びいむよんほち
ビーム 4 ポチ 1こ



2

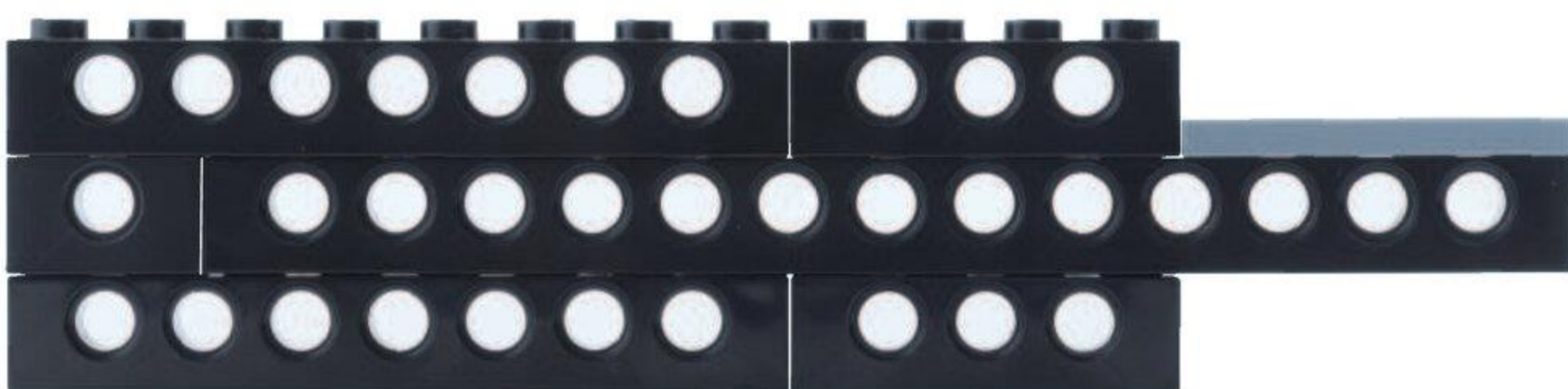
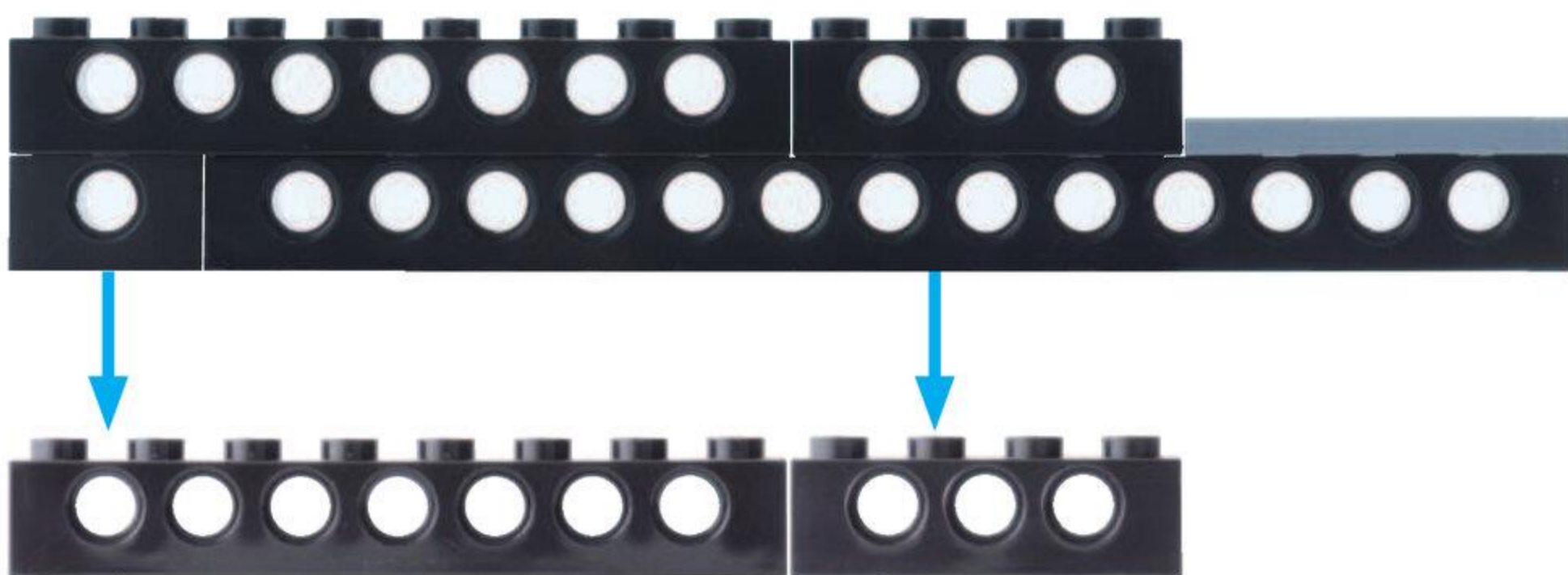

びにおんぎあ
ピニオンギア 1こ



ぎあえむ
ギア M 1こ

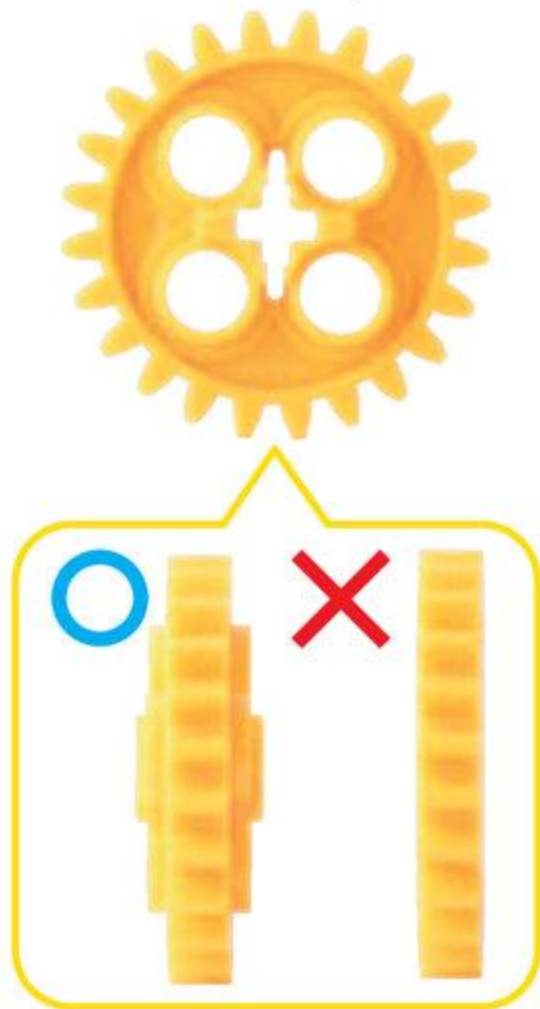

しゃふとpeg
シャフトpeg 2こ



3



4

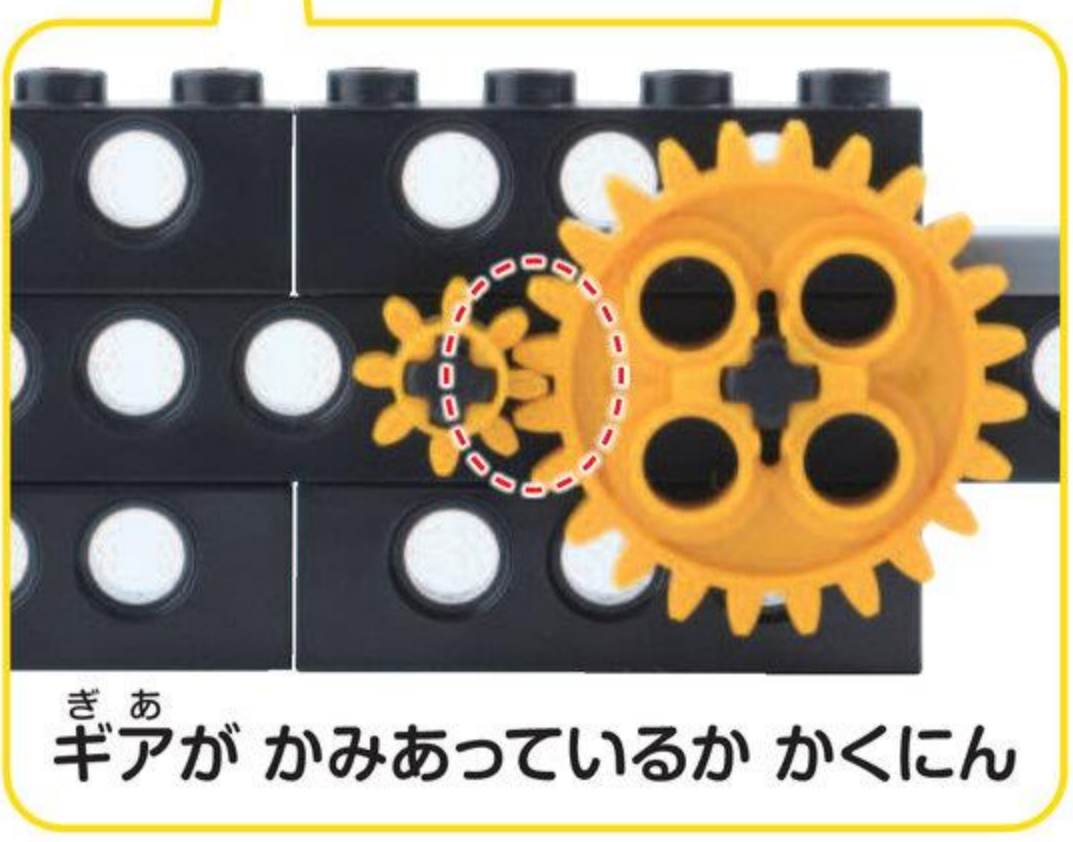
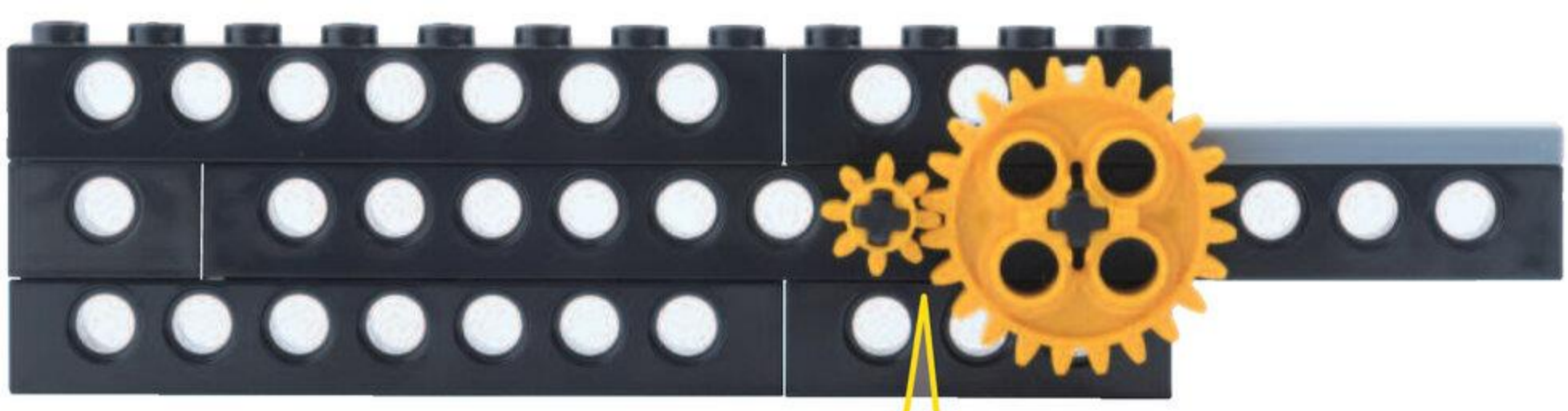
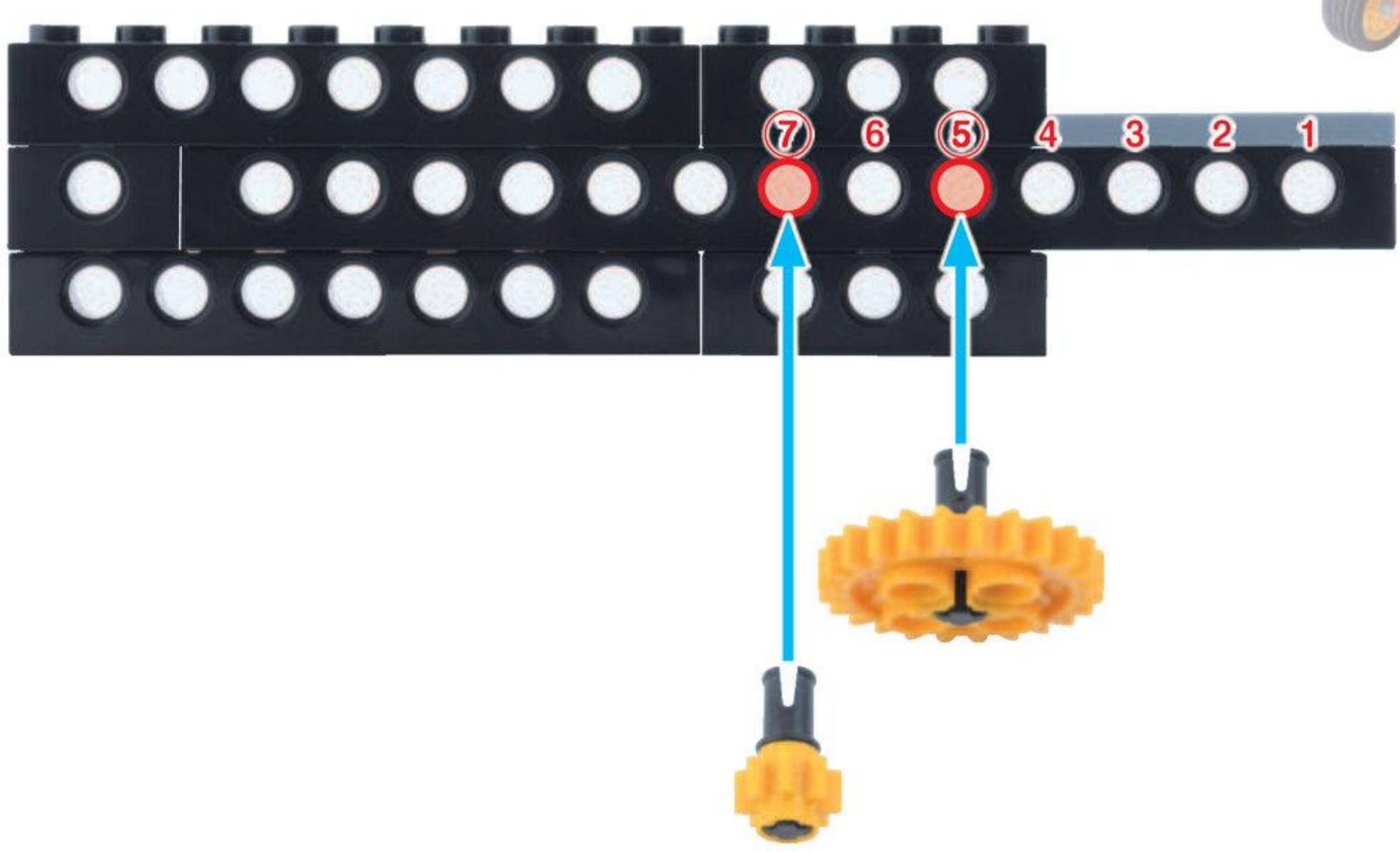

ふれえとる
プレート 2こ

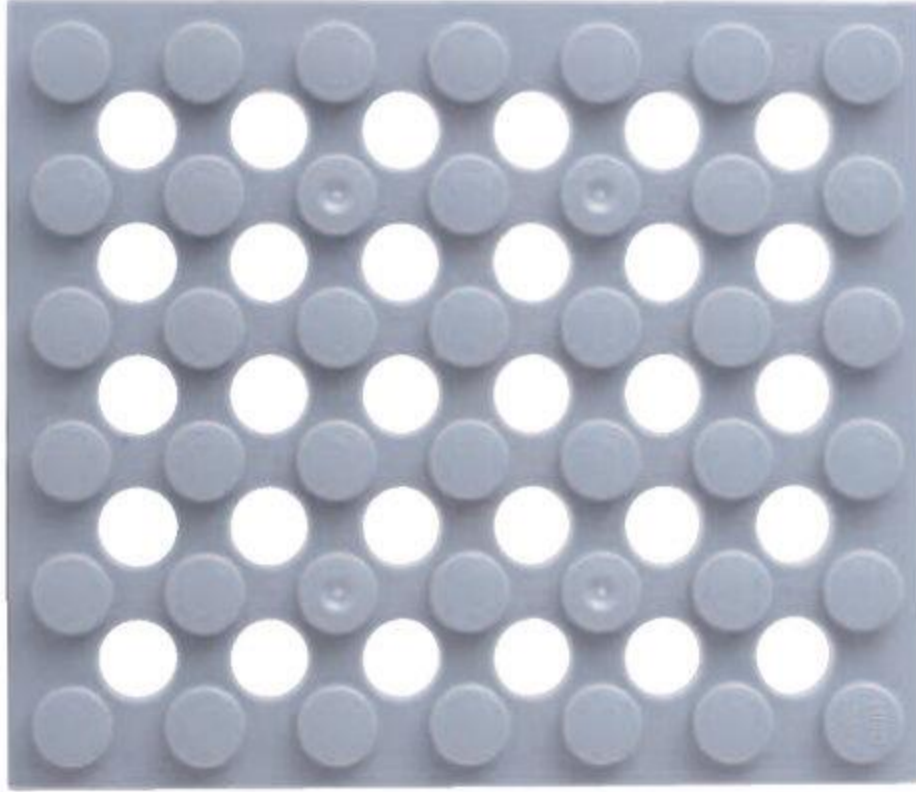

ふとふれえとゆんほち
太プレート 4ポチ 1こ

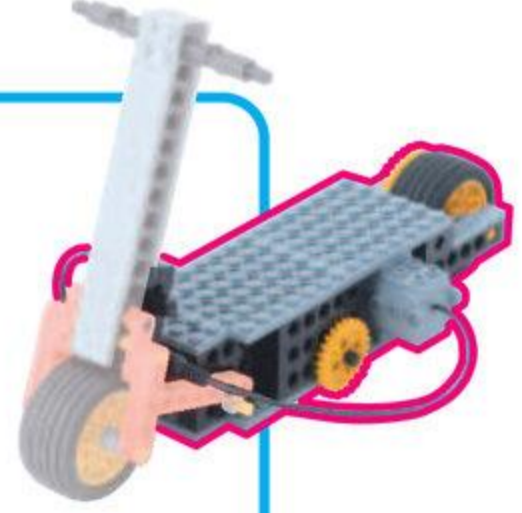

5

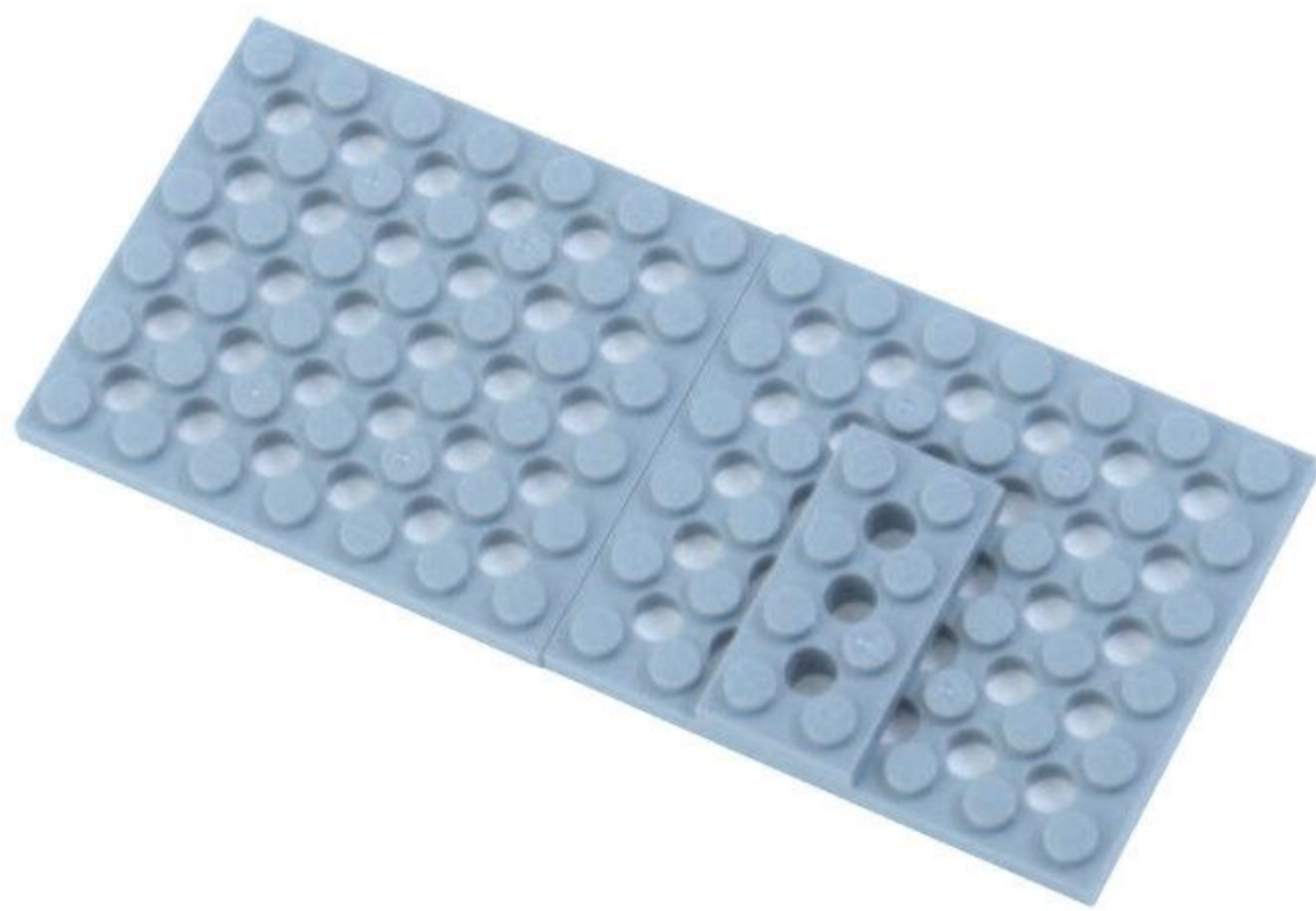
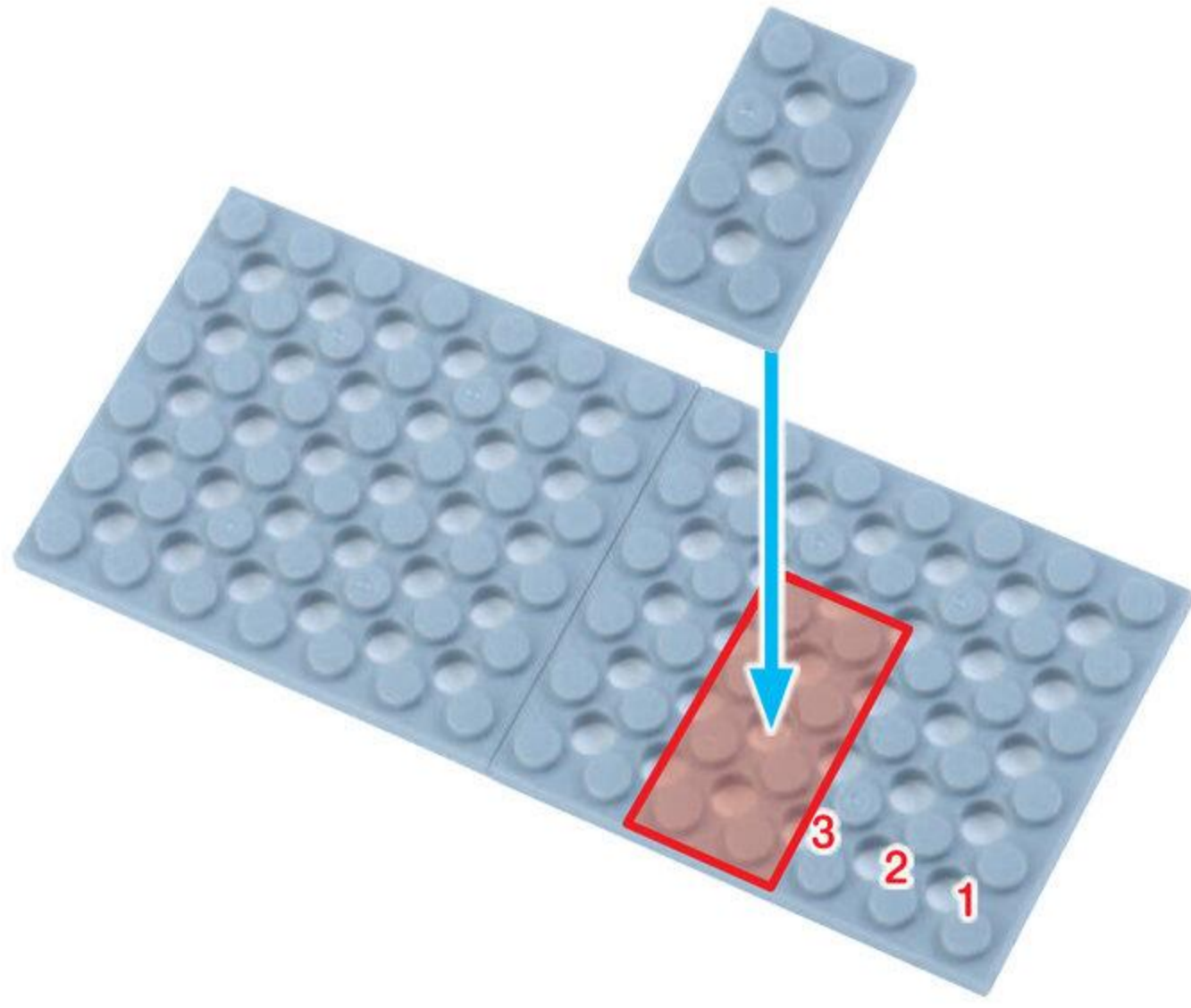

6

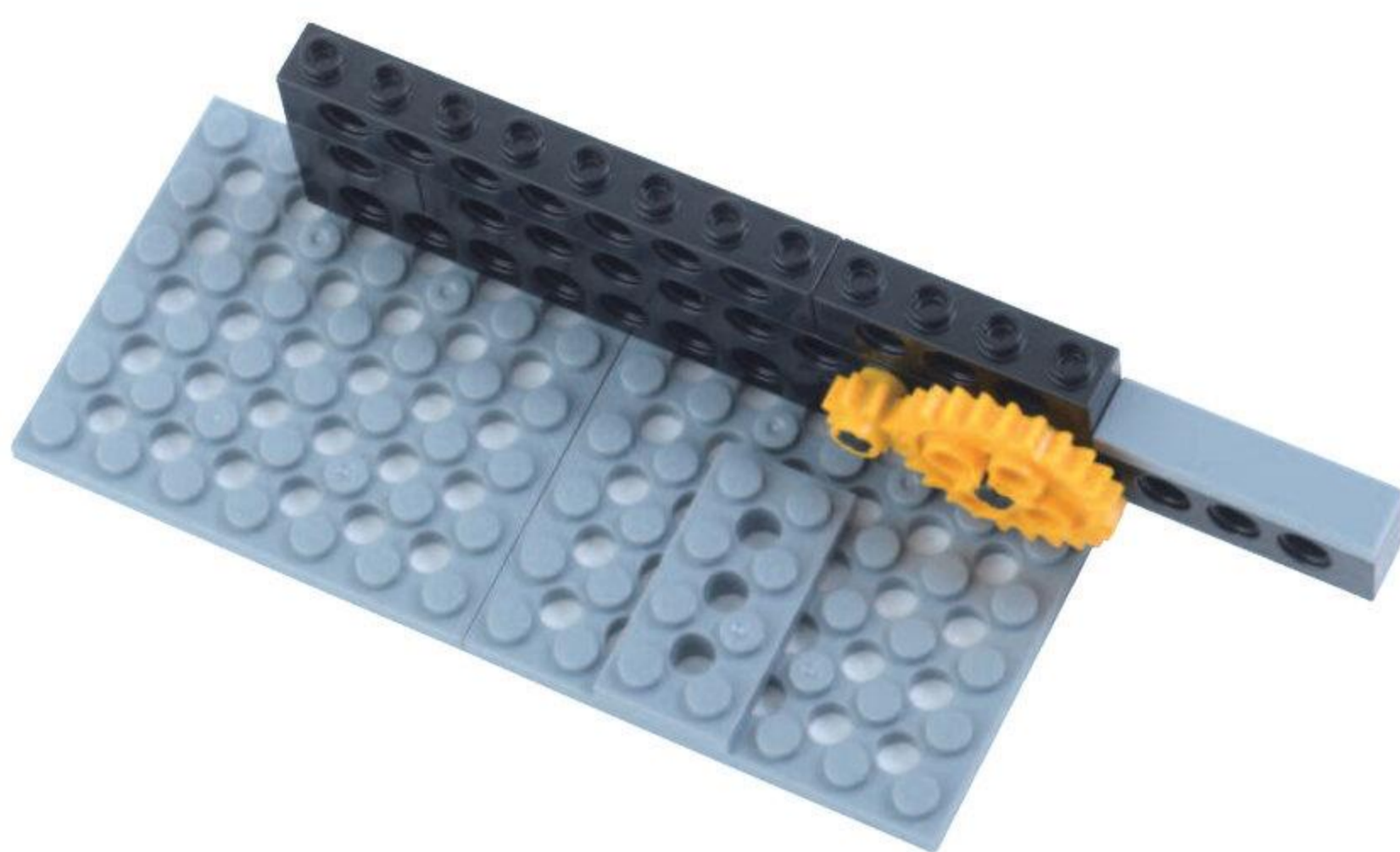
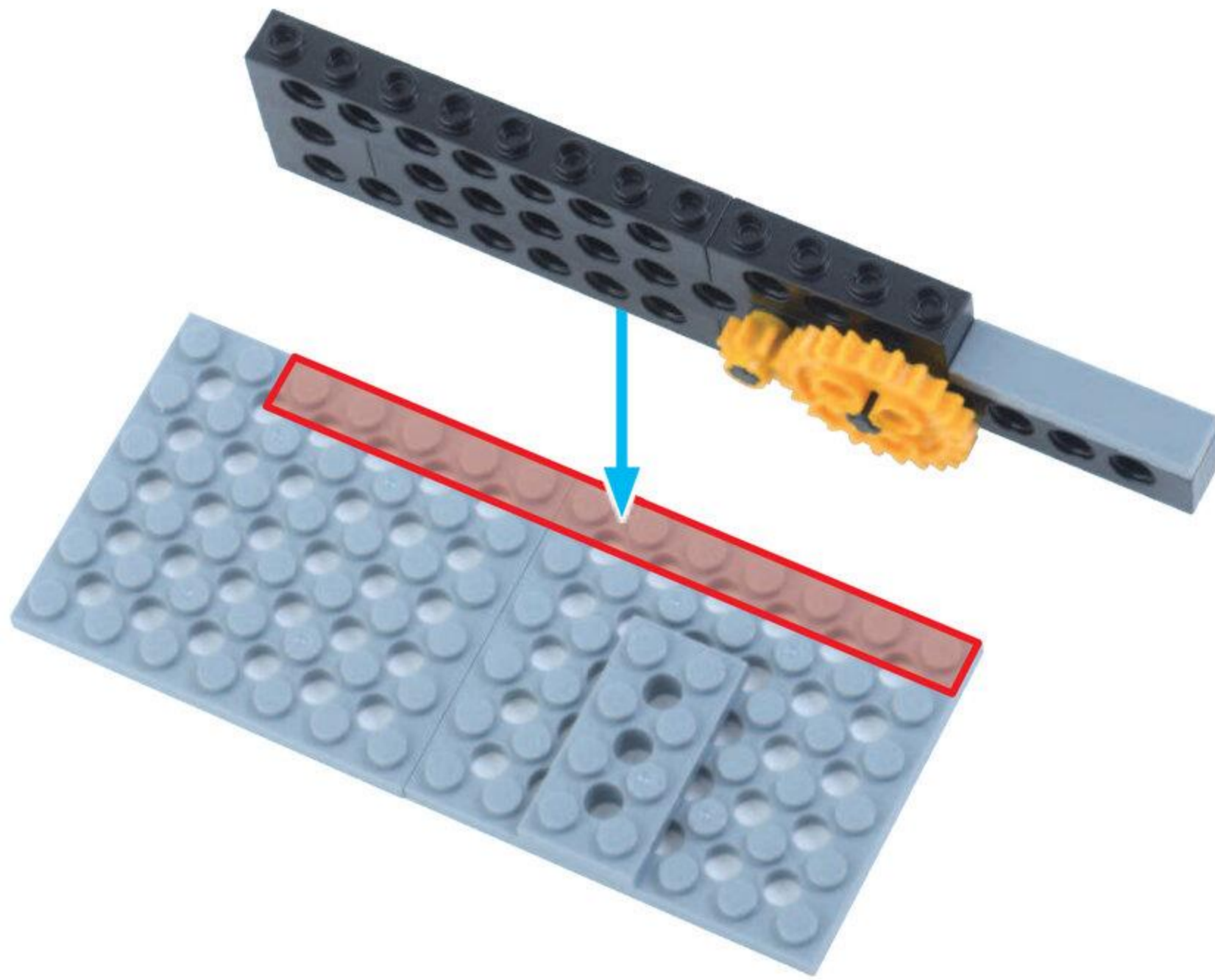

びいむよんほち
ビーム4ポチ 6こ



びいむろくほち
ビーム6ポチ 3こ

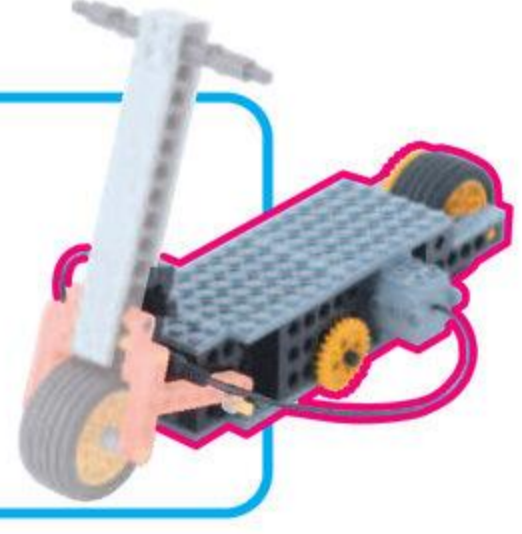

7

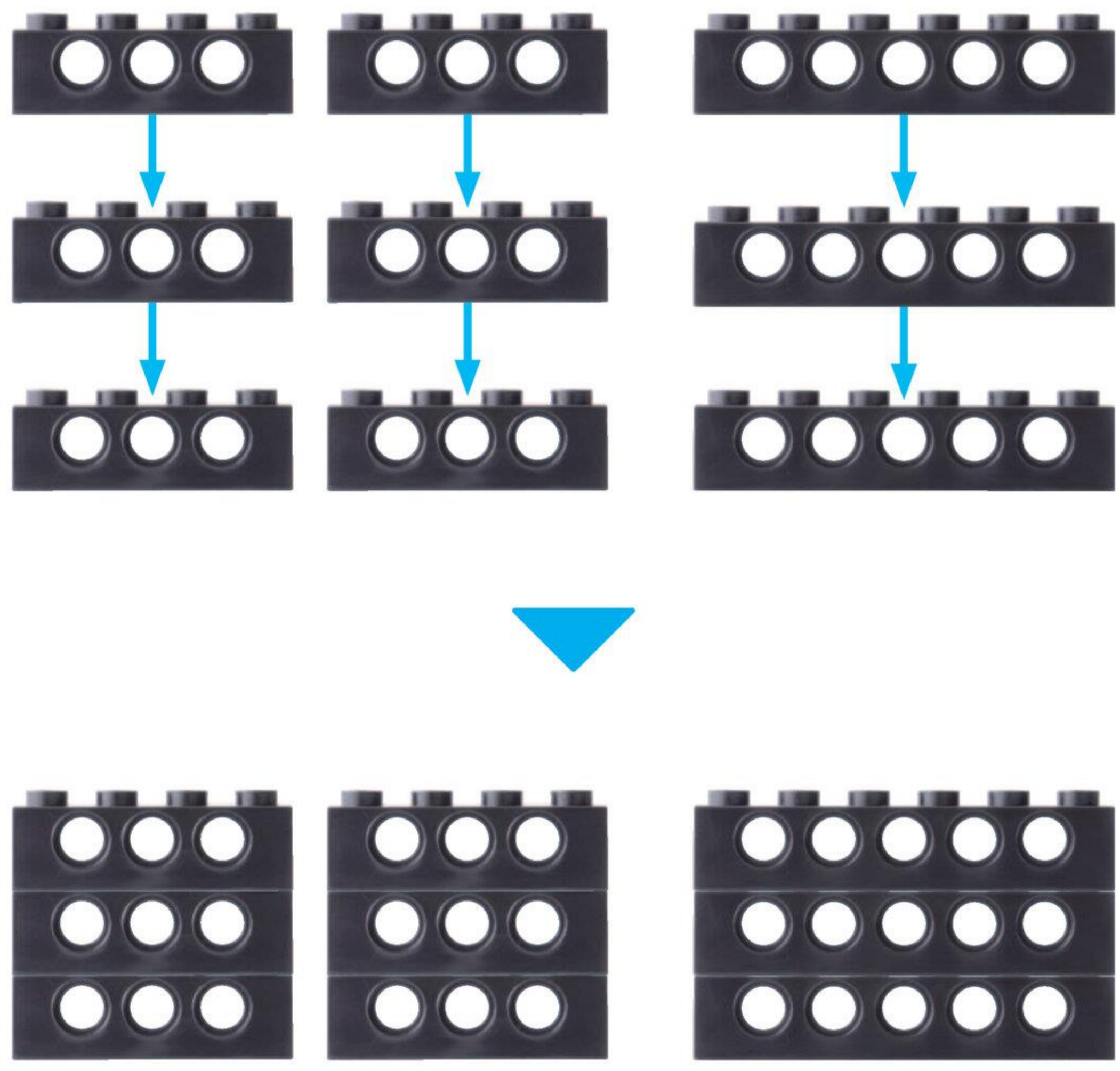

ふとぶれえとゆんぼち
太プレート4ポチ 1こ

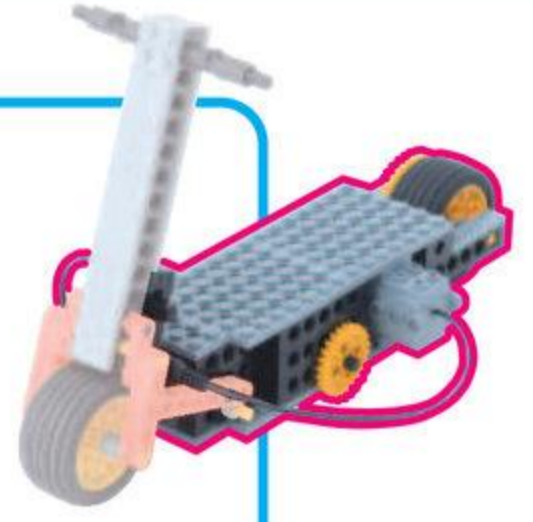

8

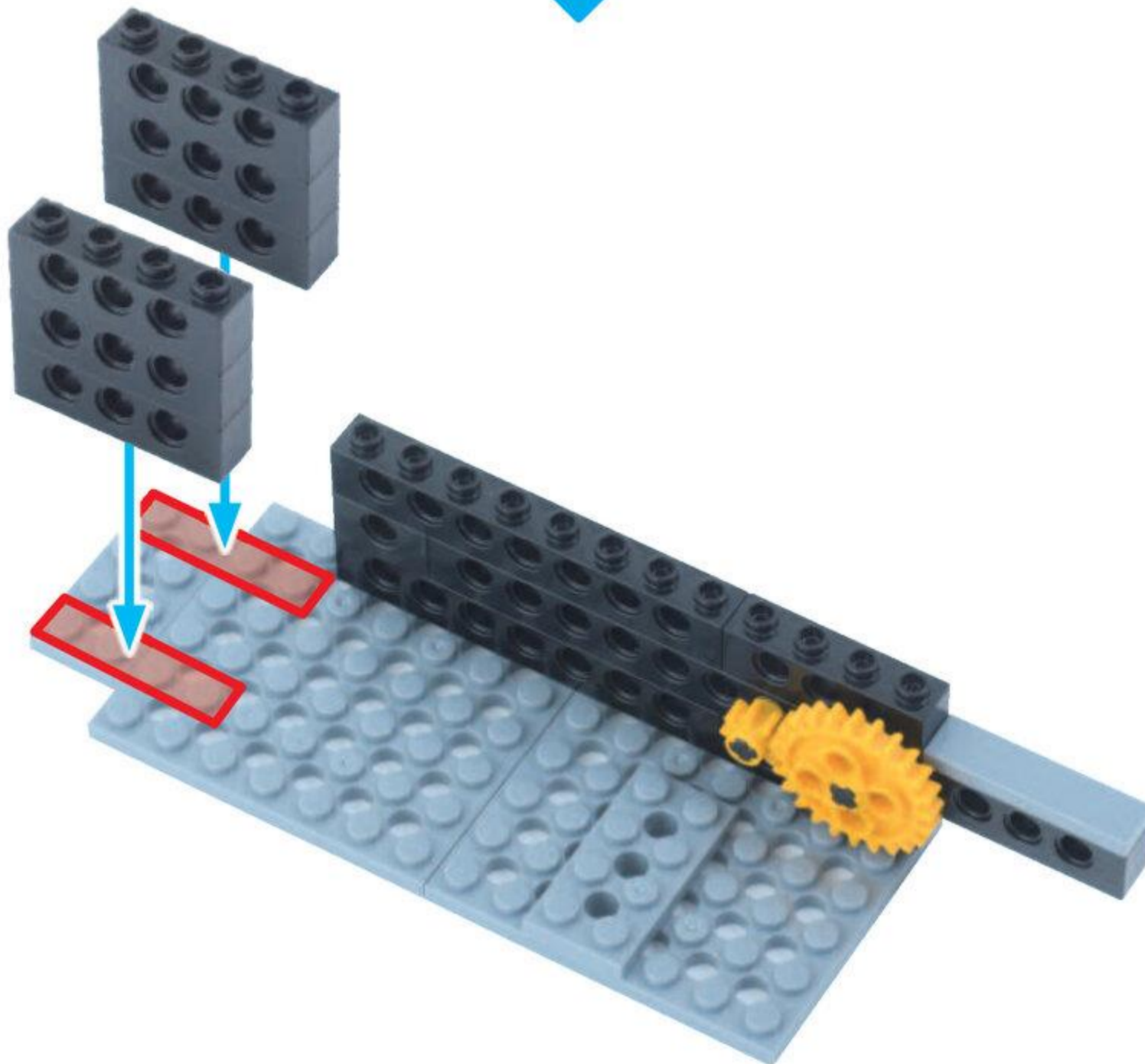
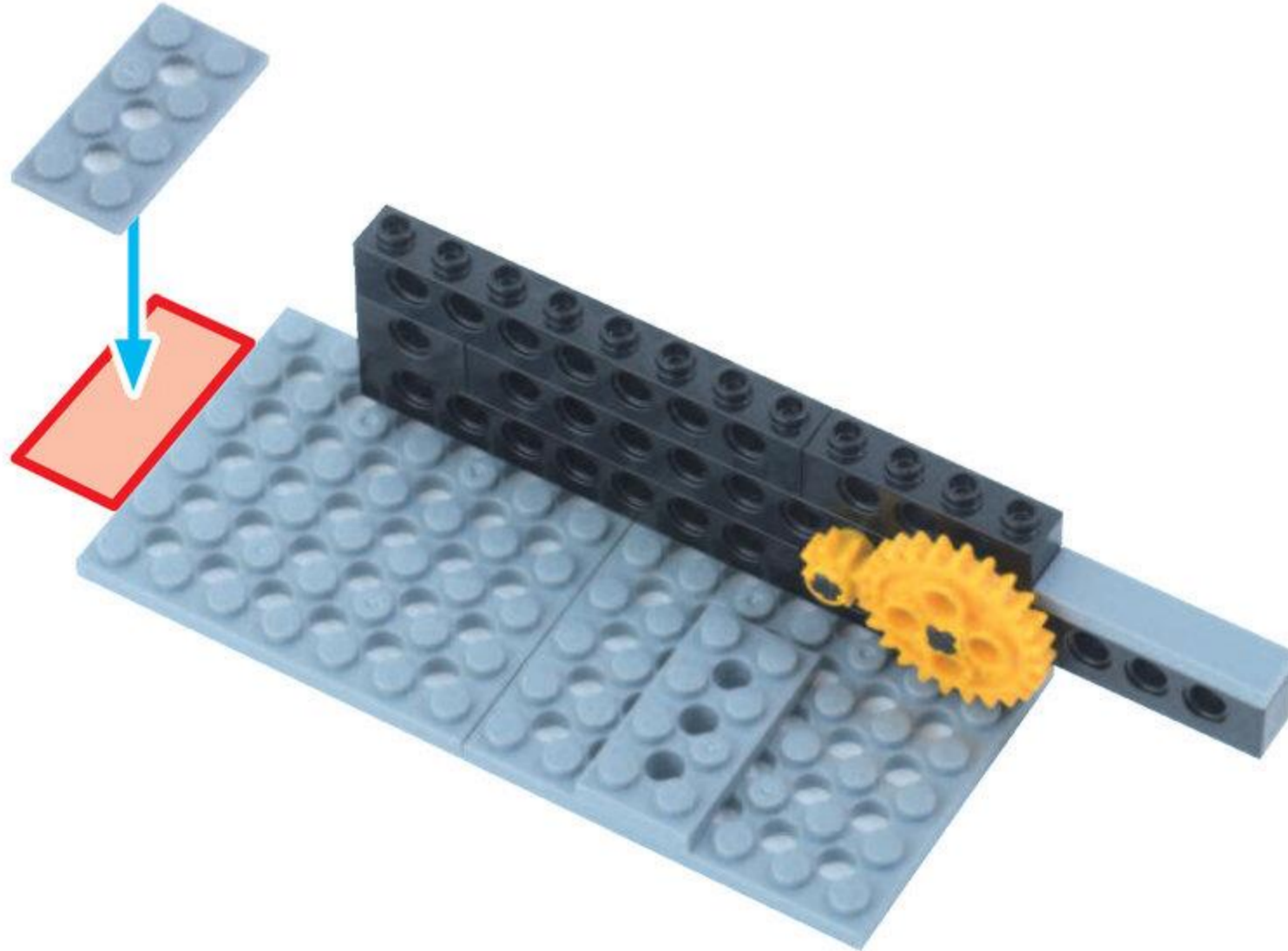

9

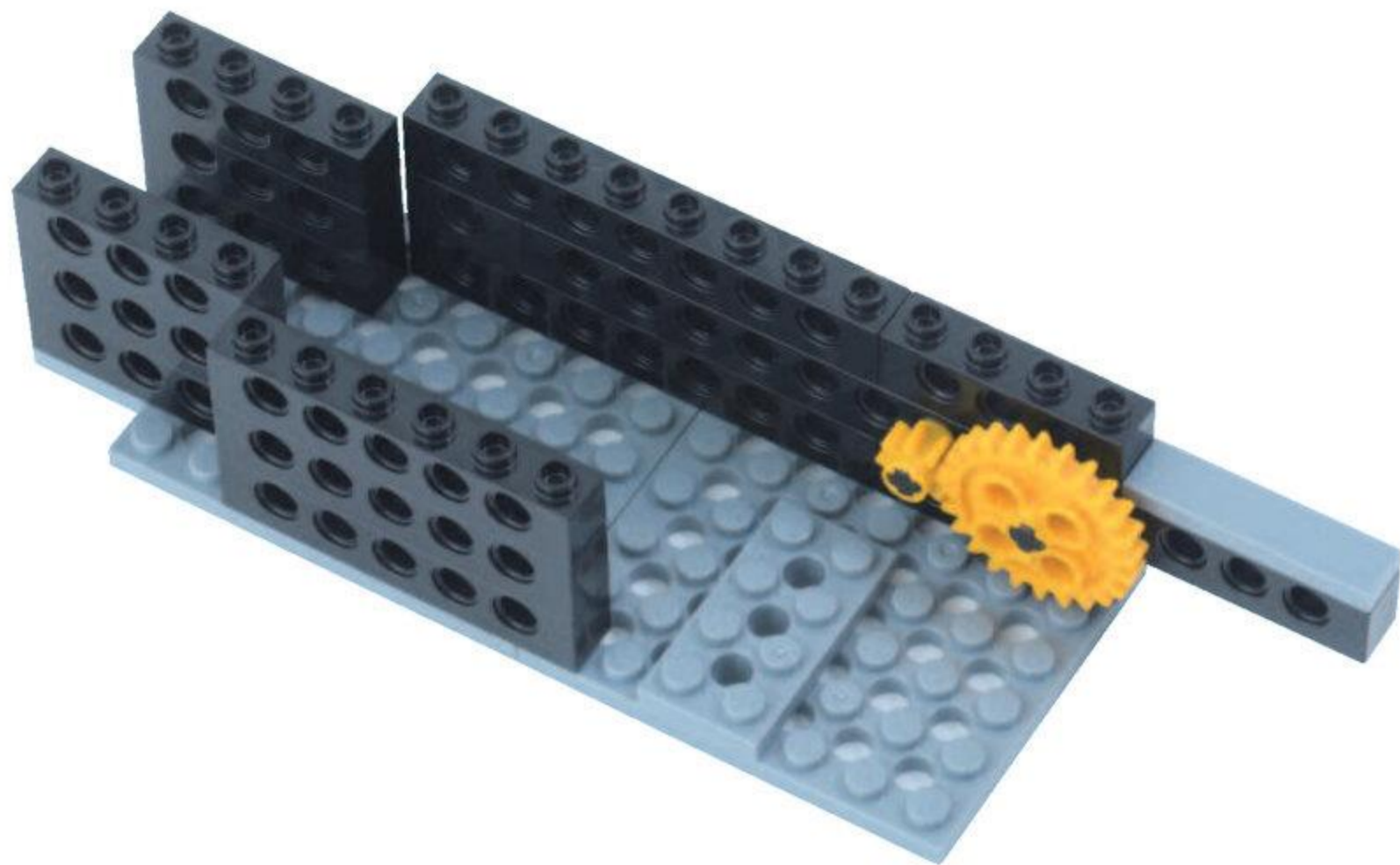
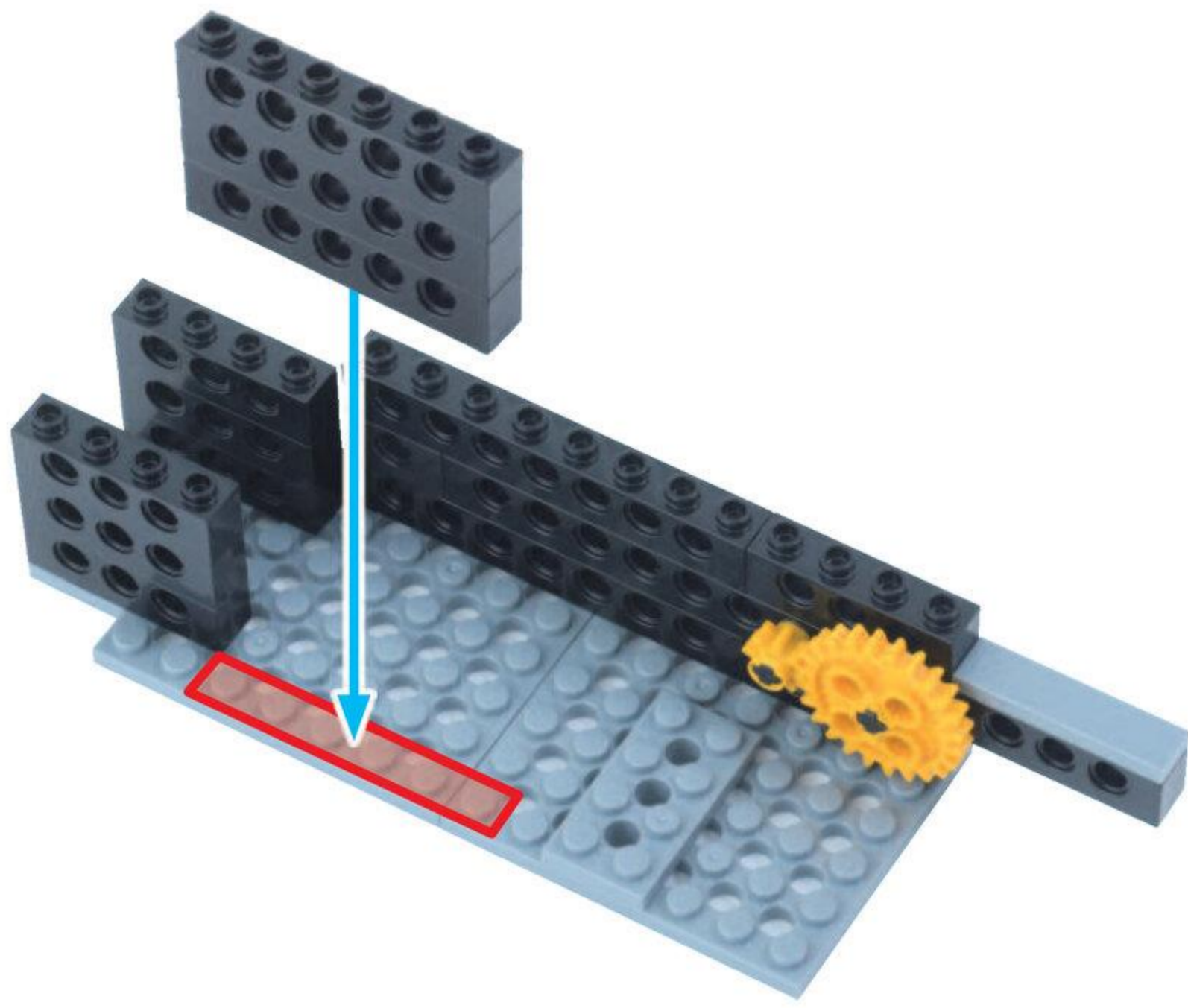

もおたあせつと
モーターセット



「じぜんくみたて
パーツを
つかうよ！」



ふとぶれえとよんほち
太プレート 4 ポチ 1 こ

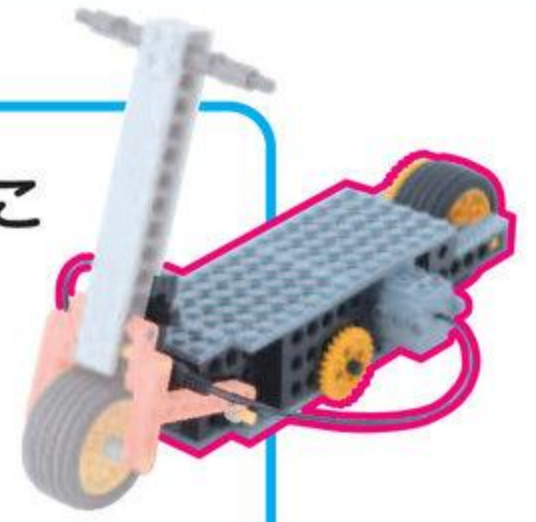

10

はずす

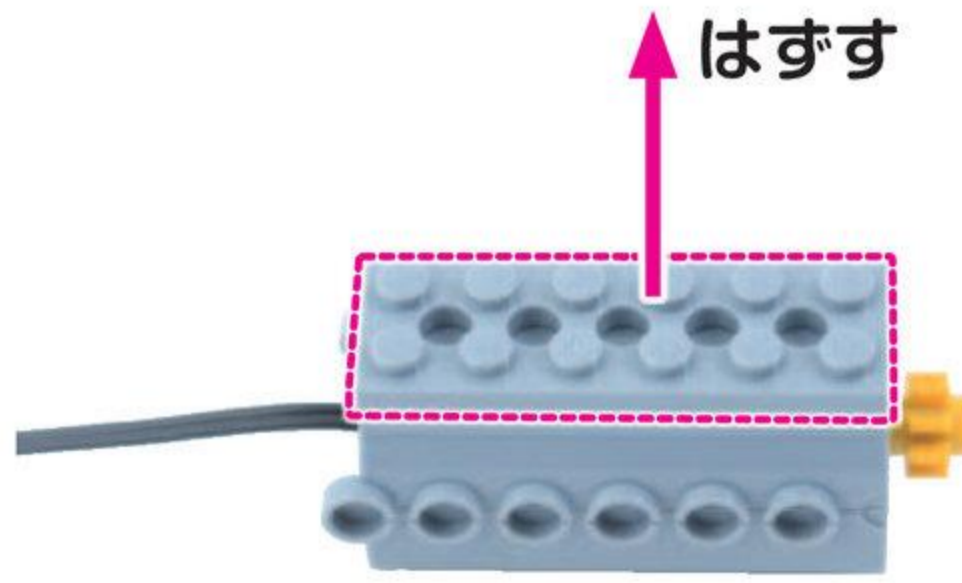

もおたあせつと
モーターセットから
ふとぶれえとろくほち
太プレート 6 ポチを
はずして
ふとぶれえとよんほち
太プレート 4 ポチを
つけるよ

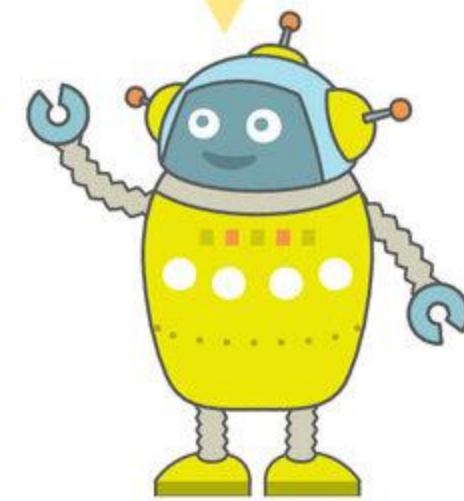

はずした ^{ばあつ} パーツは
しまおう

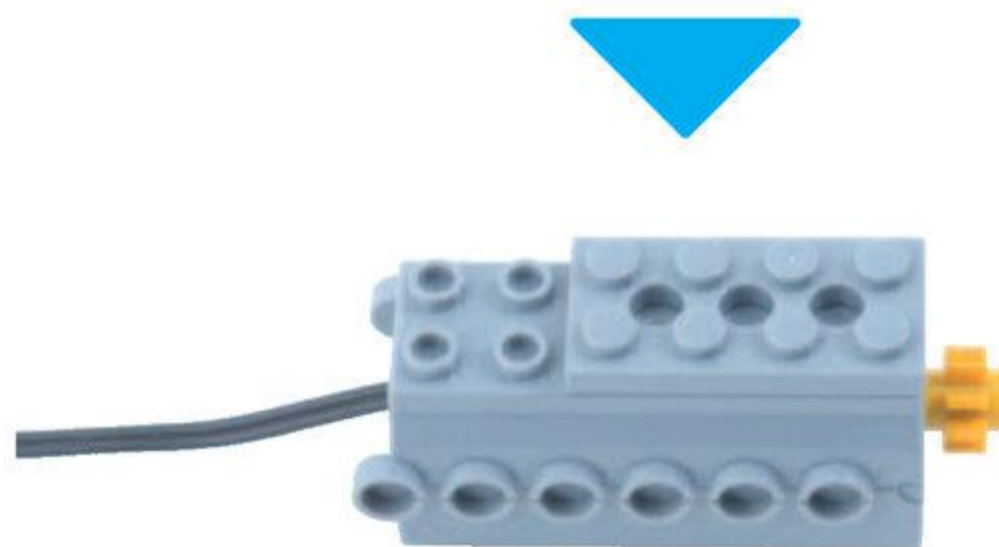
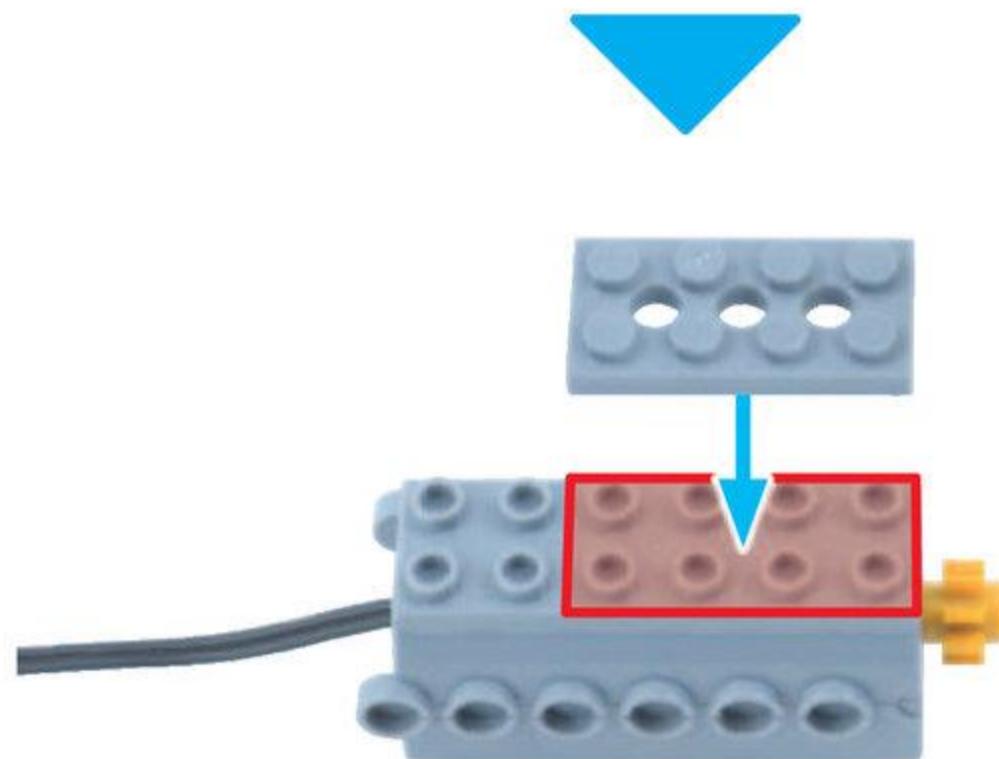
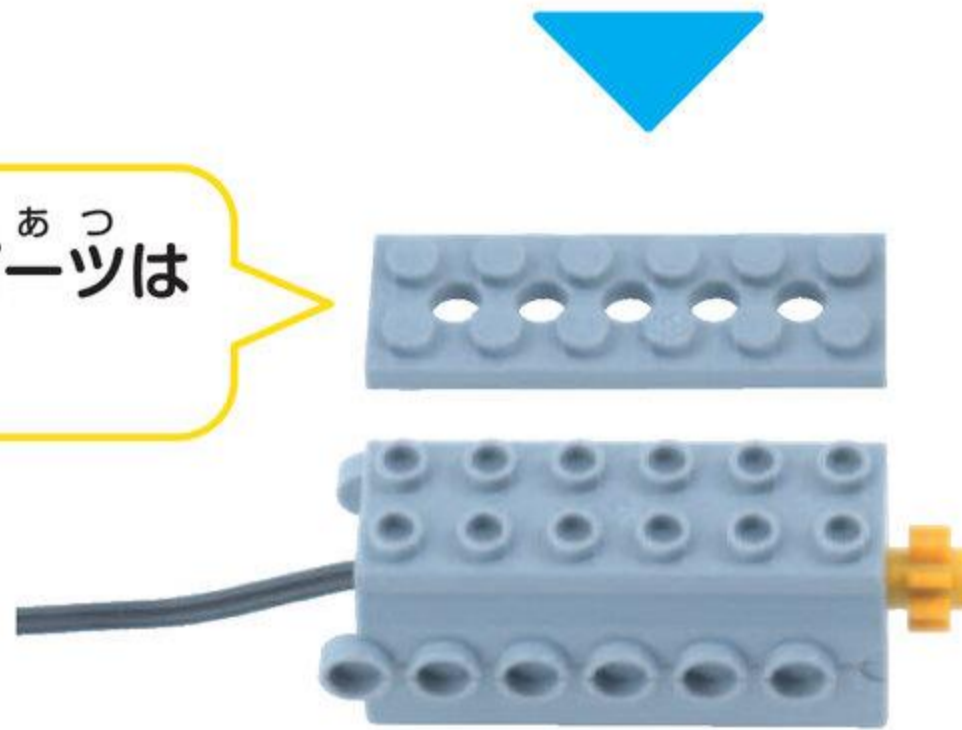

11

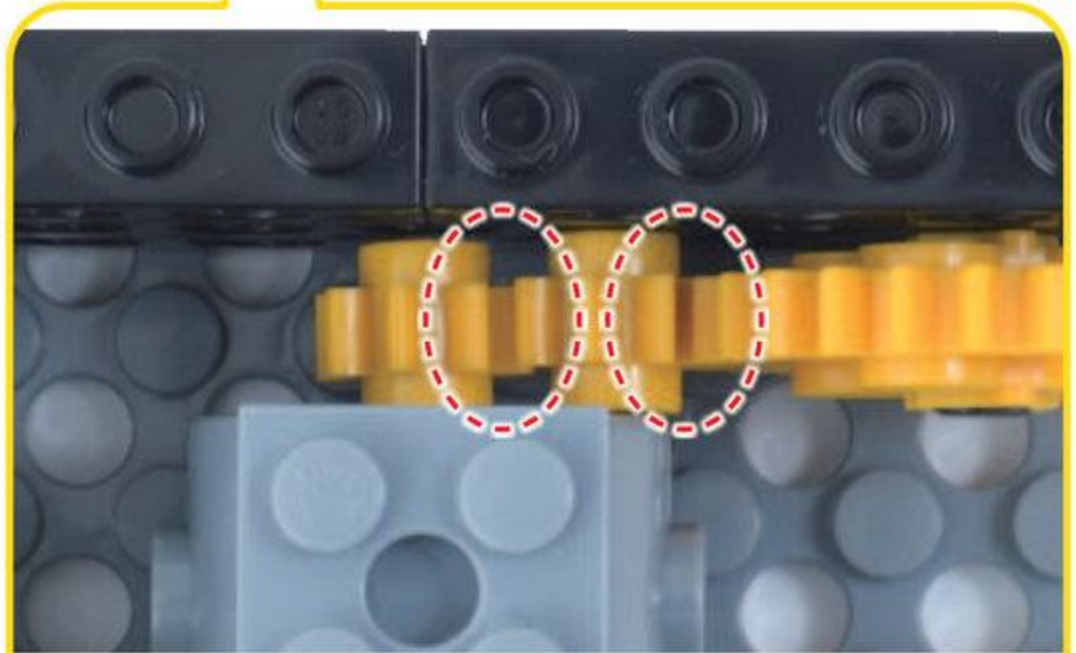
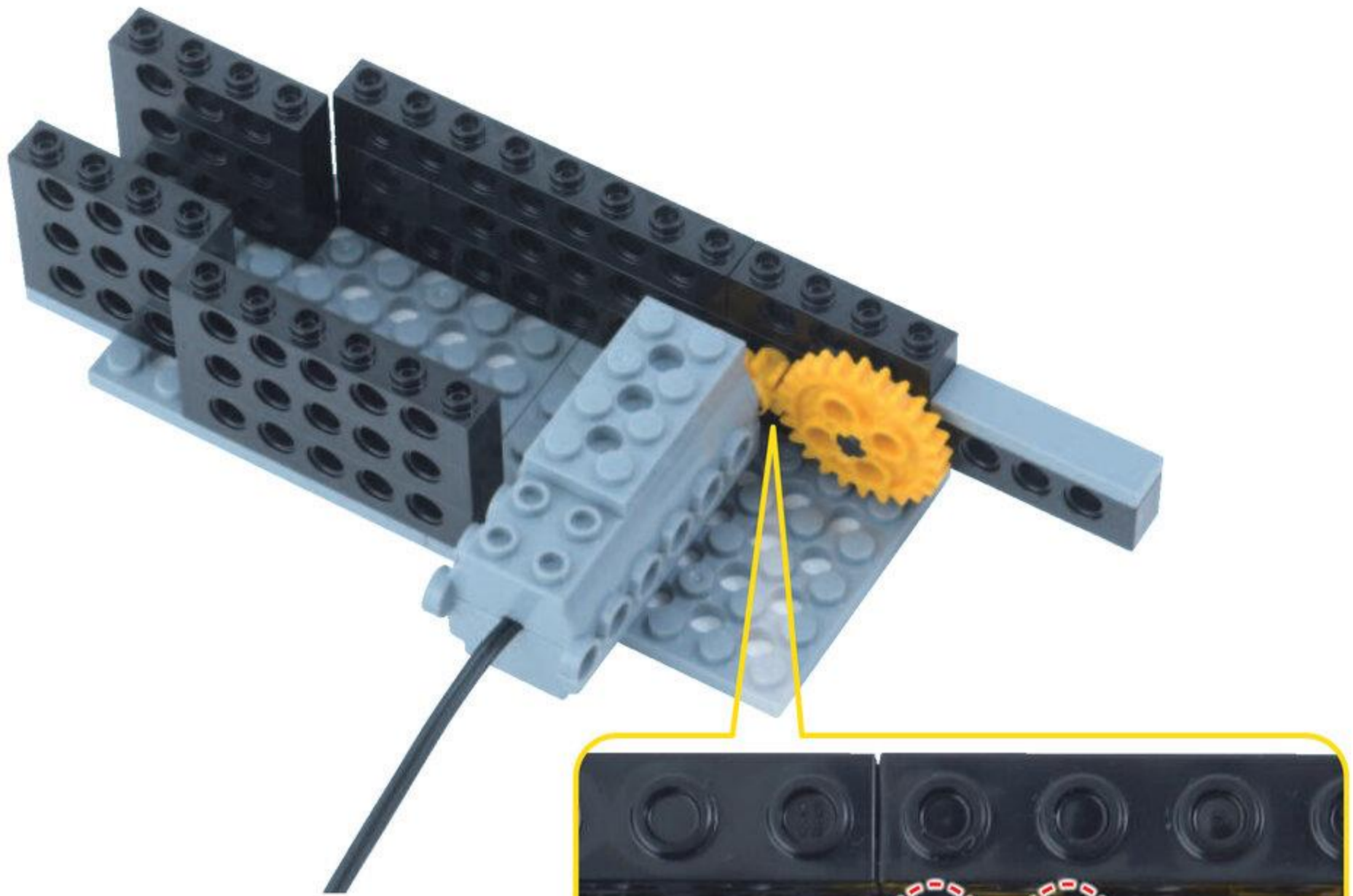
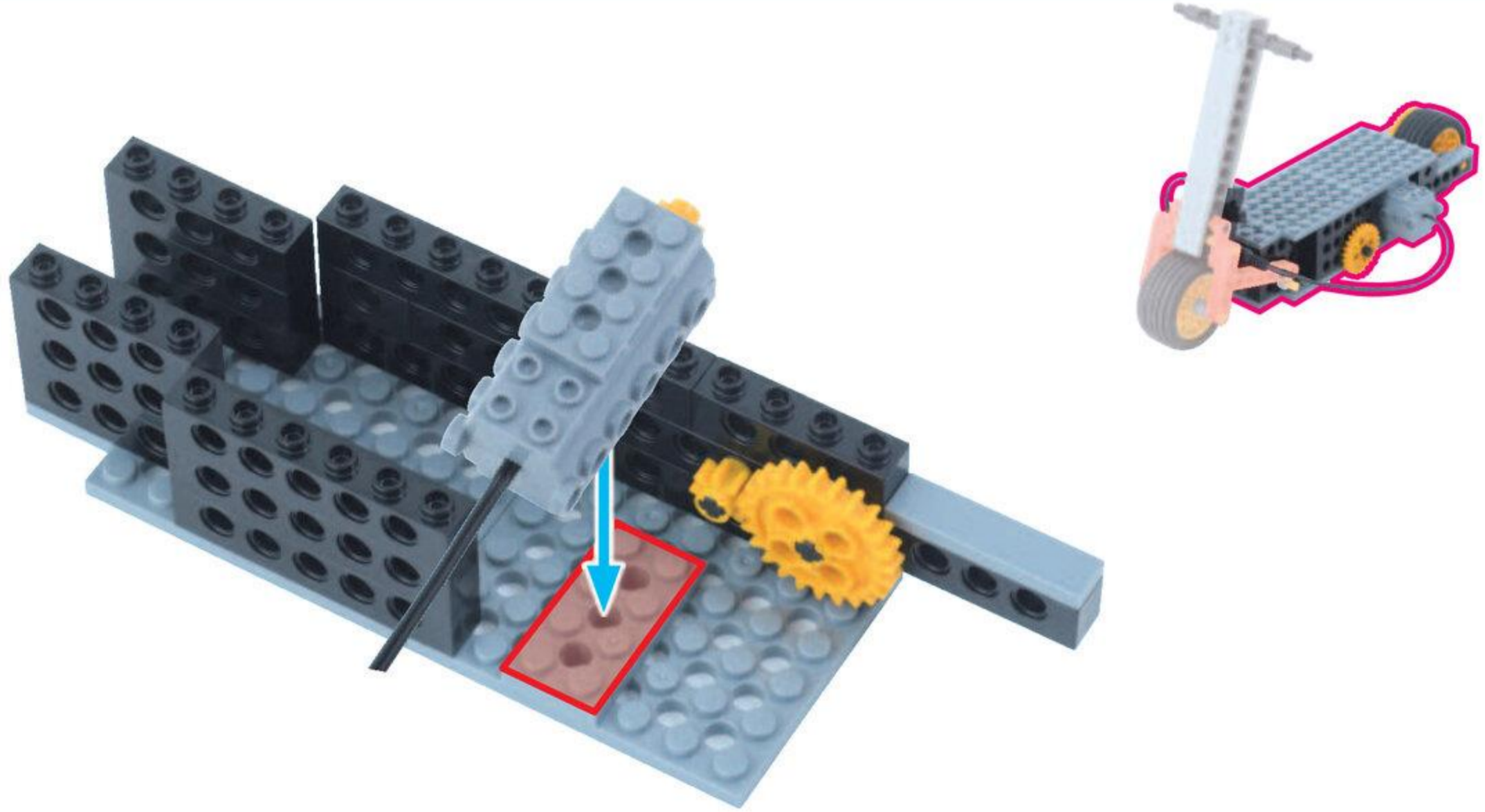

ギアが かみあっているか かくにん

ばってりいほっくす すらいどすいっち 1こ
バッテリーボックス / スライドスイッチ 1こ

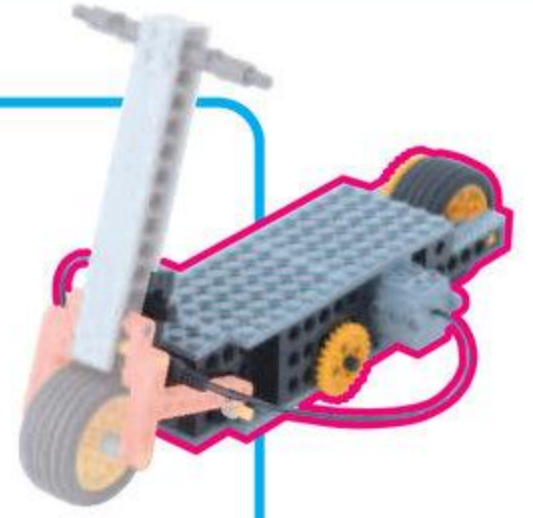

12

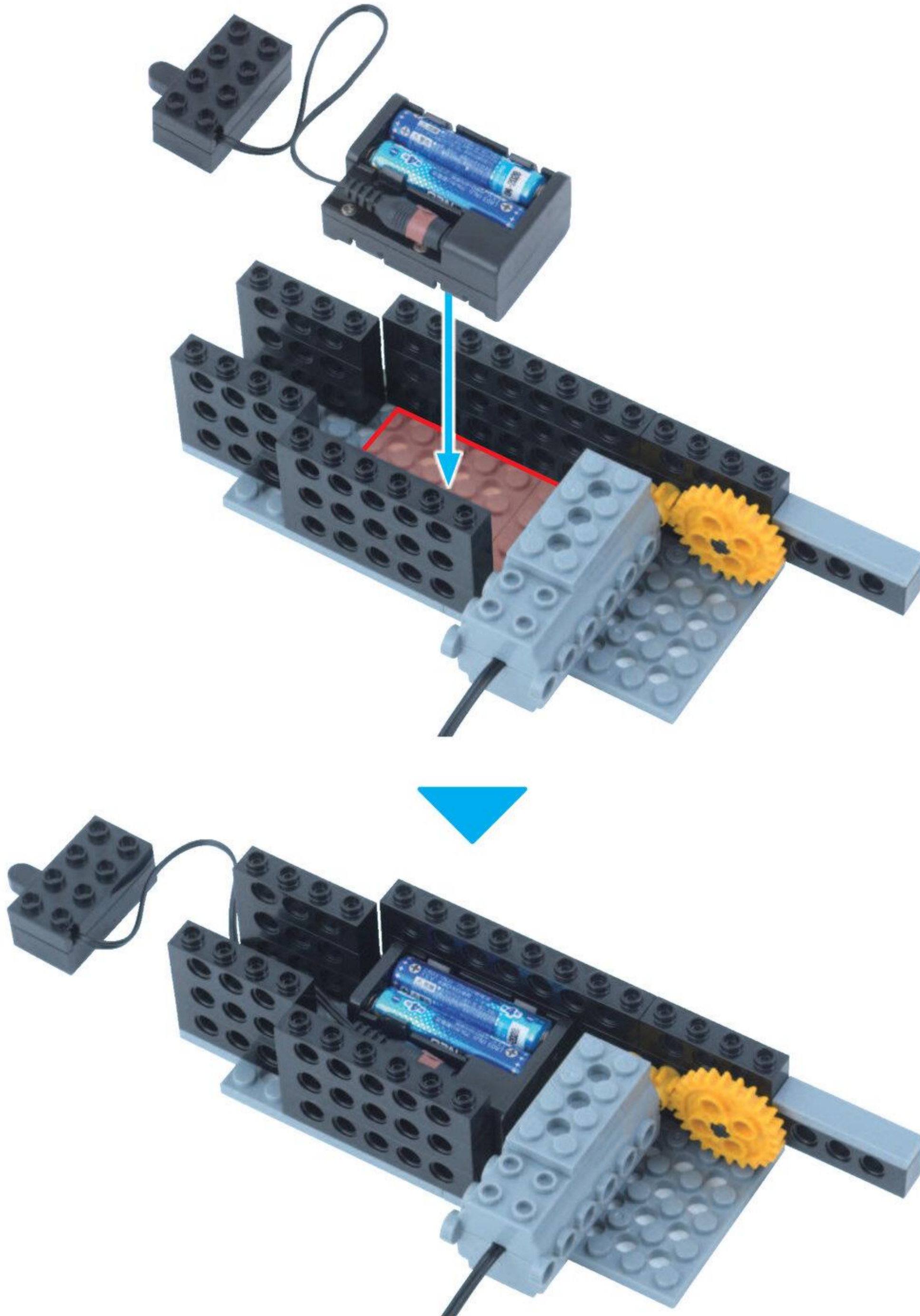

ふれえとる
プレートL 1こ

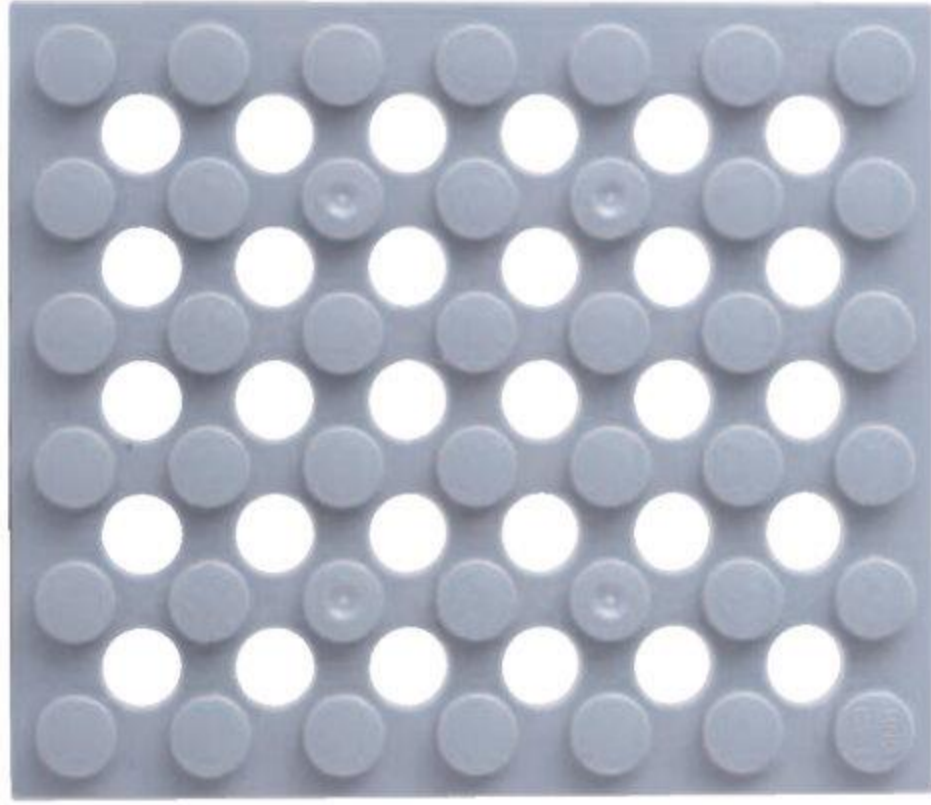

ふとふれえとよんほち
太プレート4ポチ 1こ



13

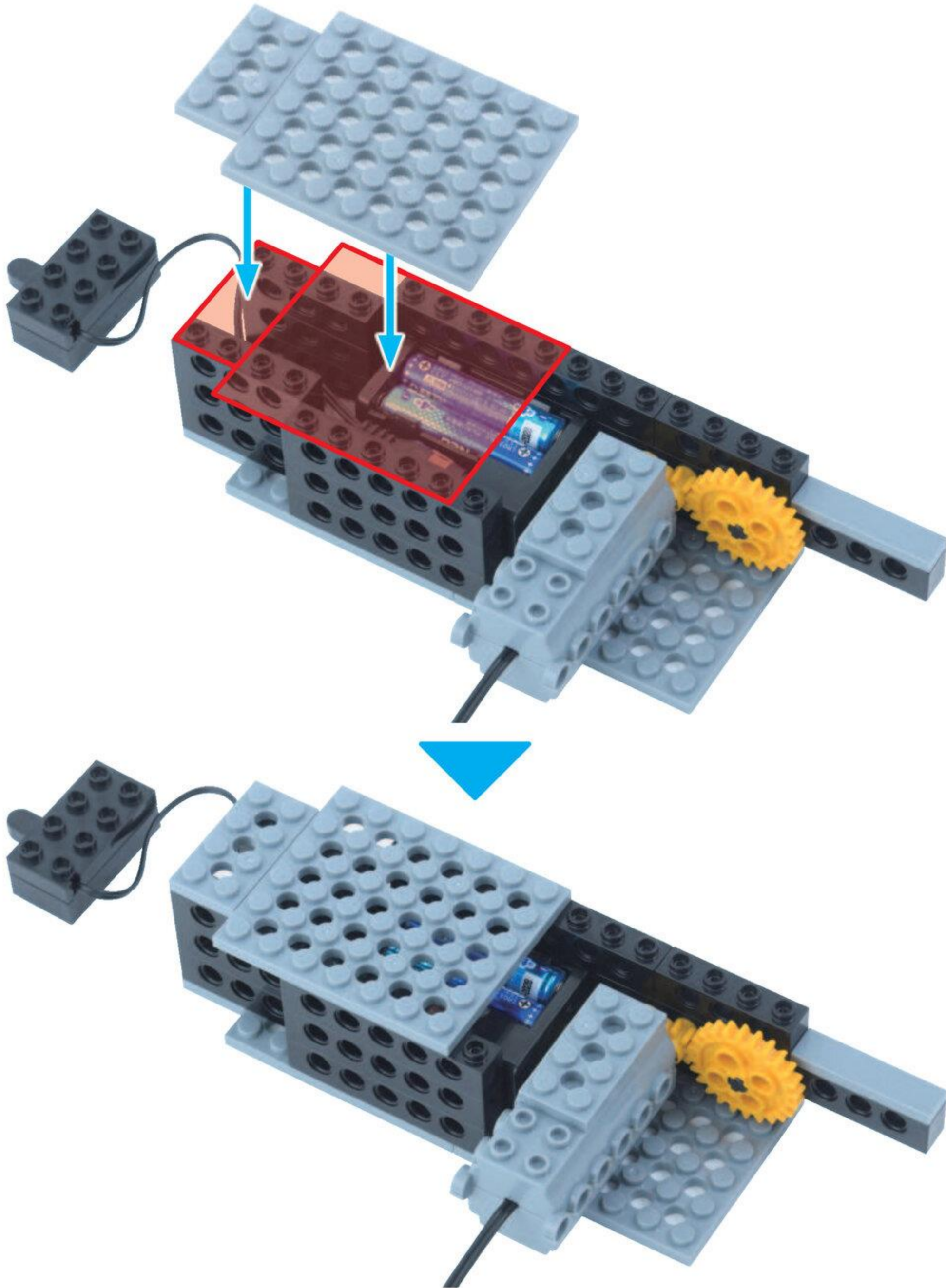

タイヤ
タイヤ 1こ



ギア
ギア 1こ

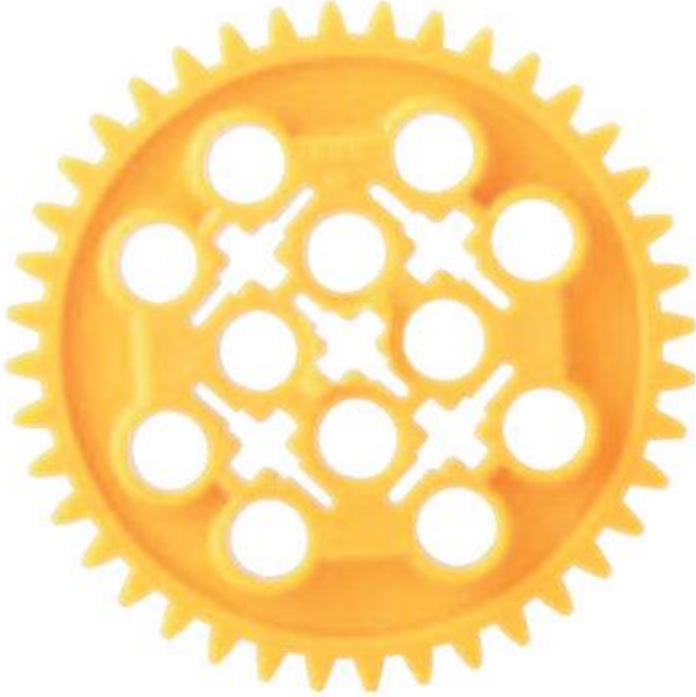

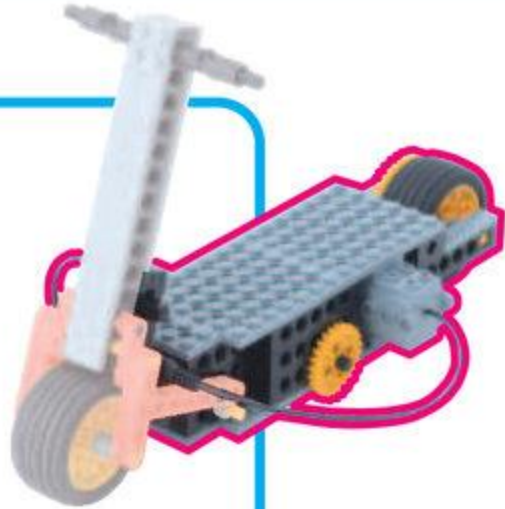

ぶっしゅ
ブッシュ 1こ





シャフト
シャフト 6ポチ 1こ



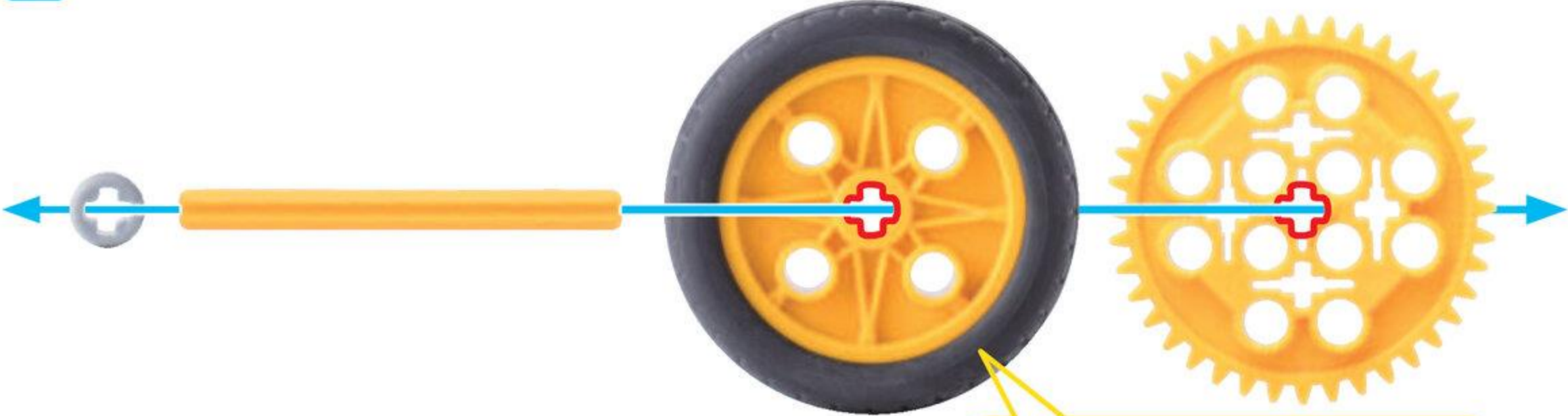

ながさに
ちゅうい

14













タイヤ
タイヤの むきに ちゅうい
へこんでいるほうが うら

びいむろくぼち
ビーム6ポチ 1こ



たいる
タイル 1こ



しゃふとびいむにぼち
シャフトビーム2ポチ 2こ

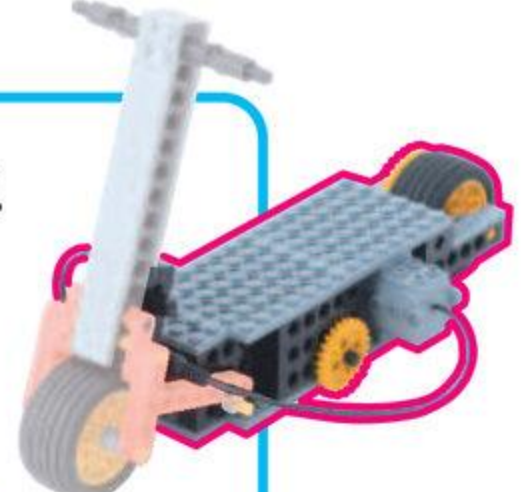
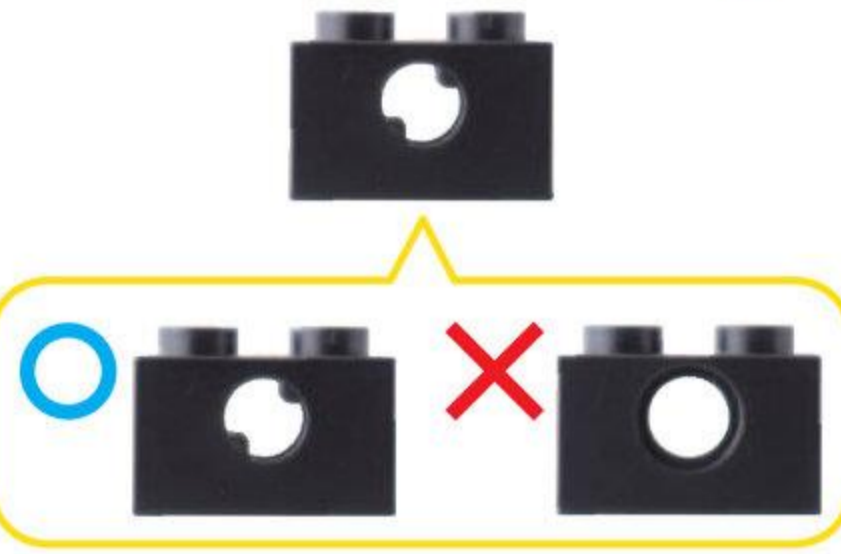

15

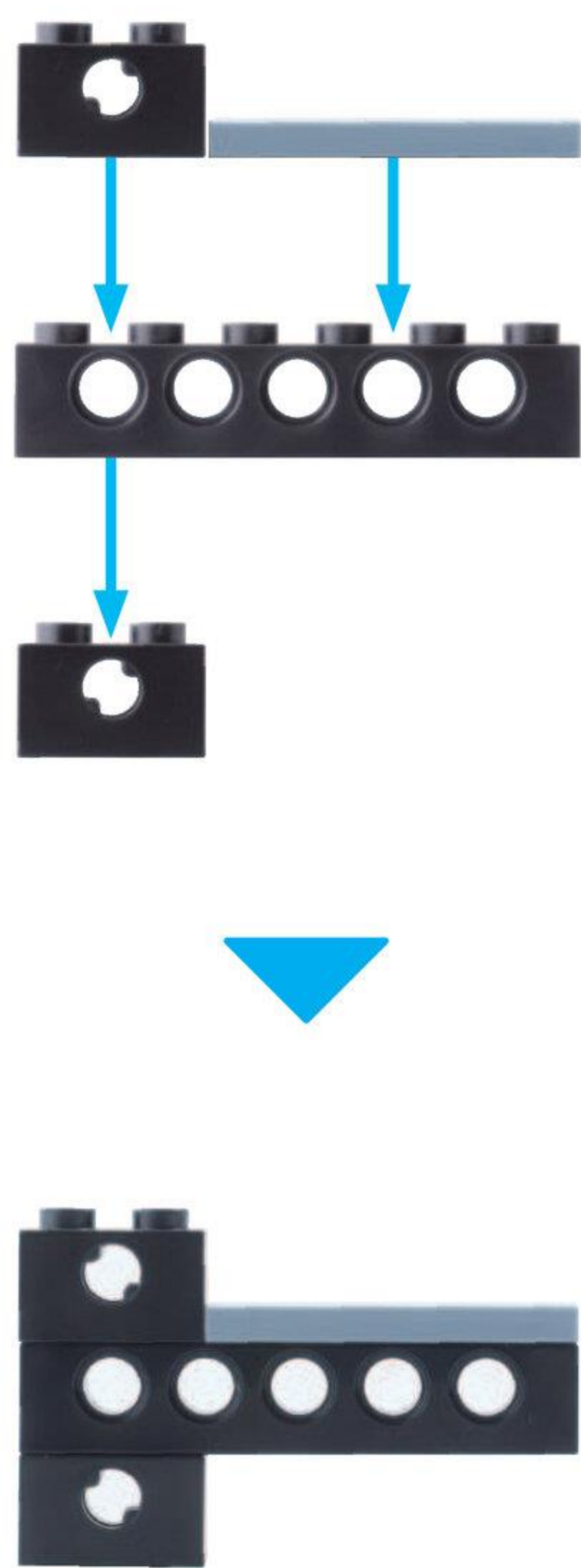

16

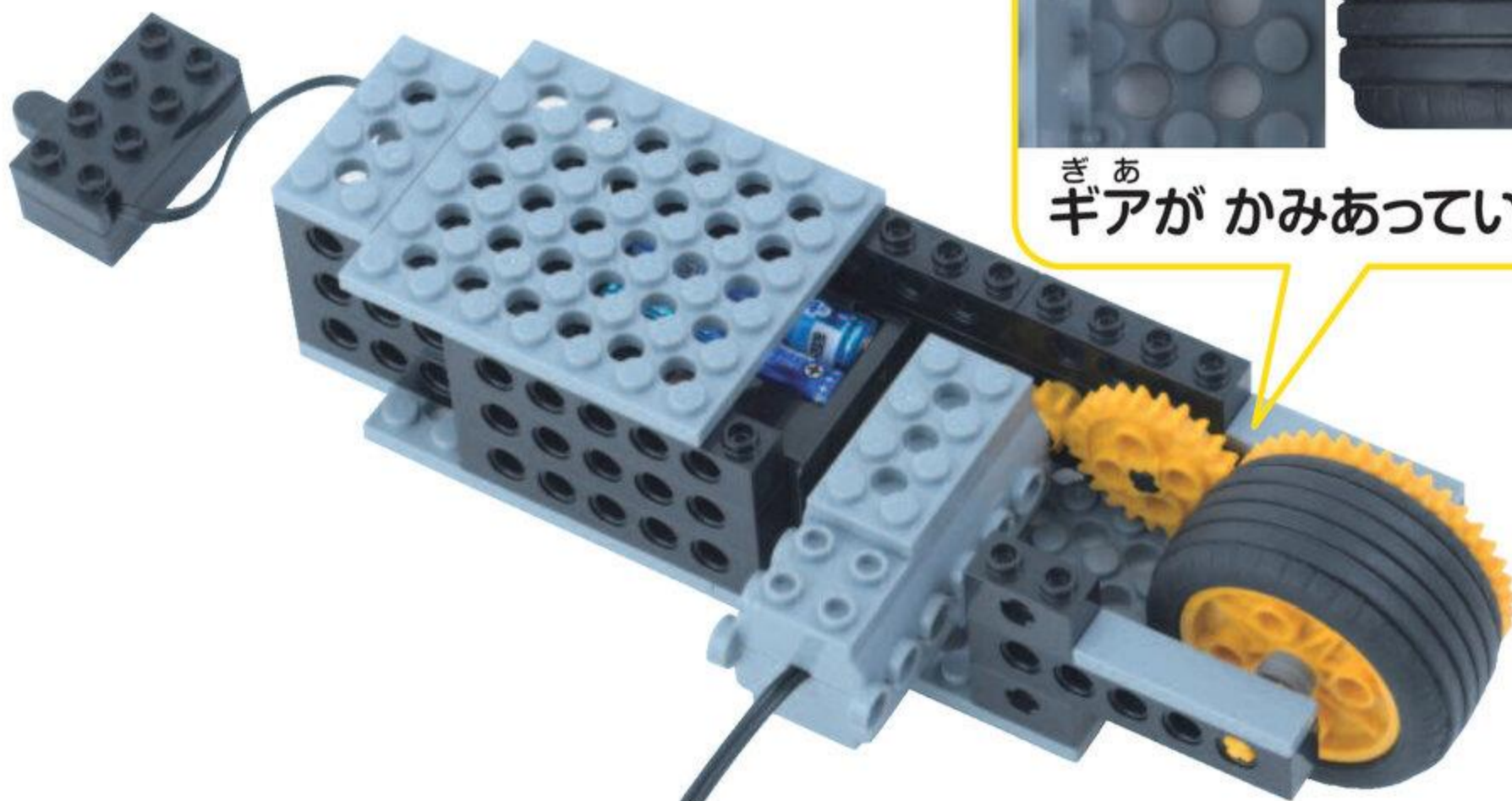
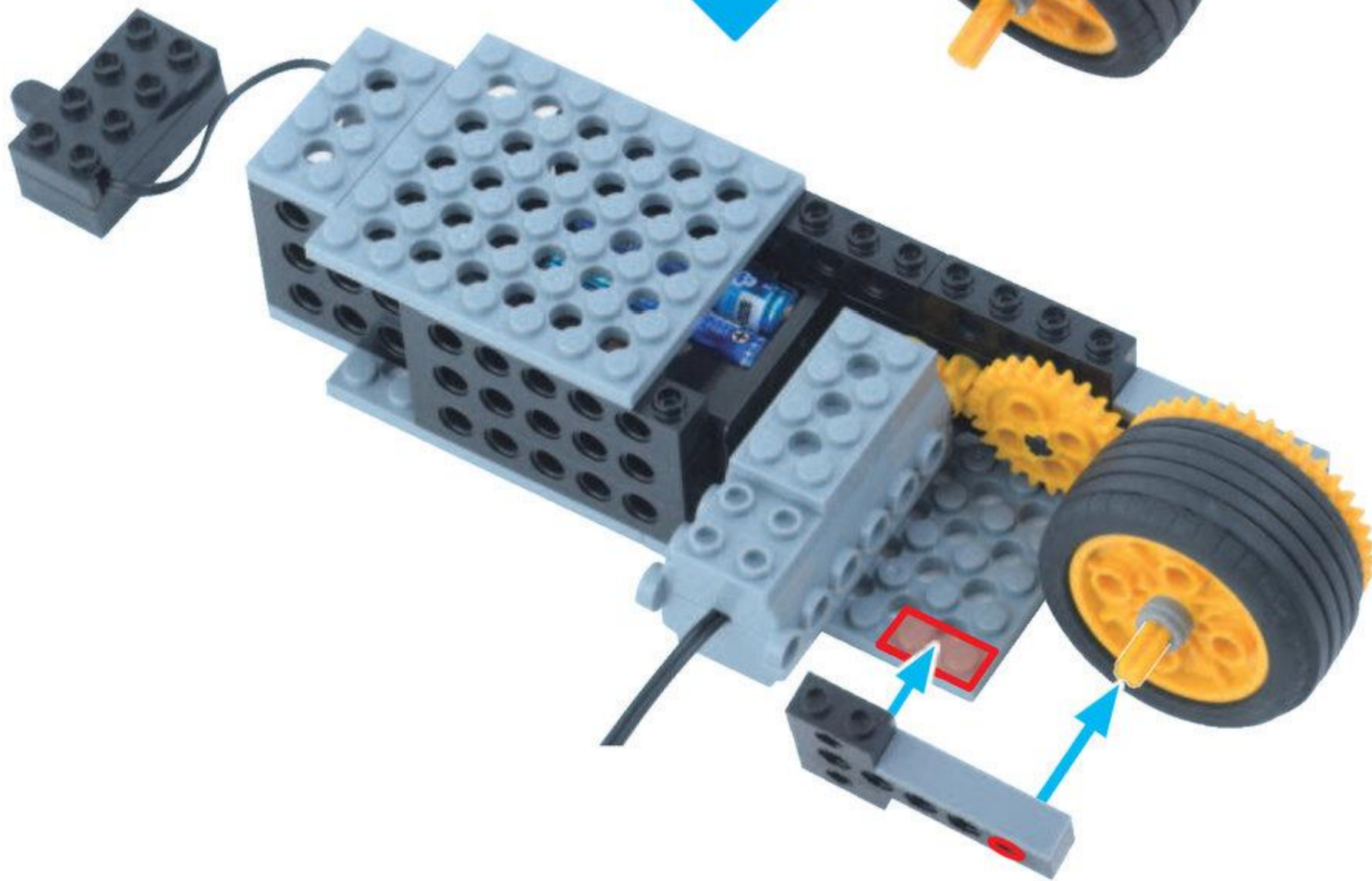
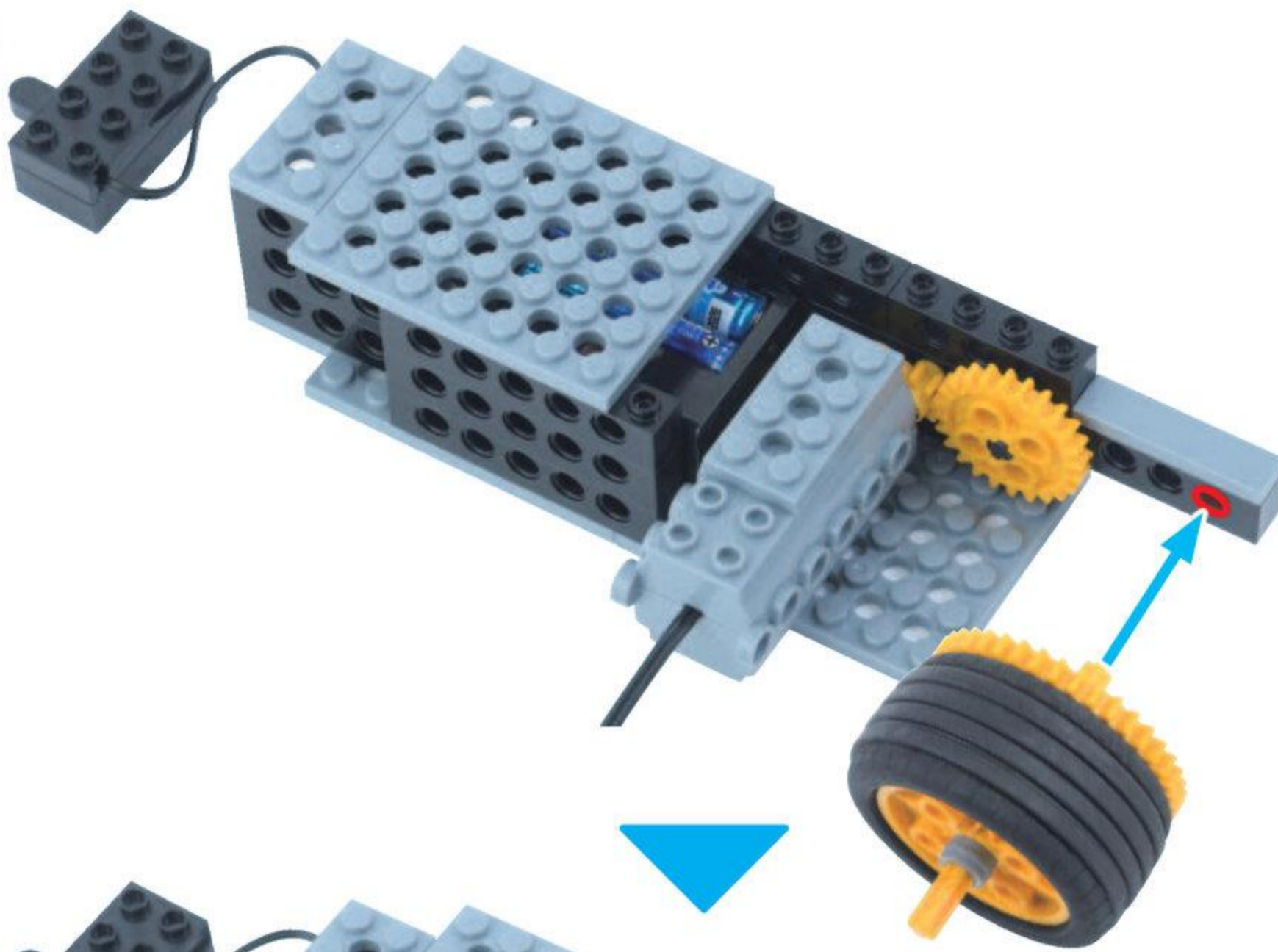

ぶれえとる
プレート 1こ

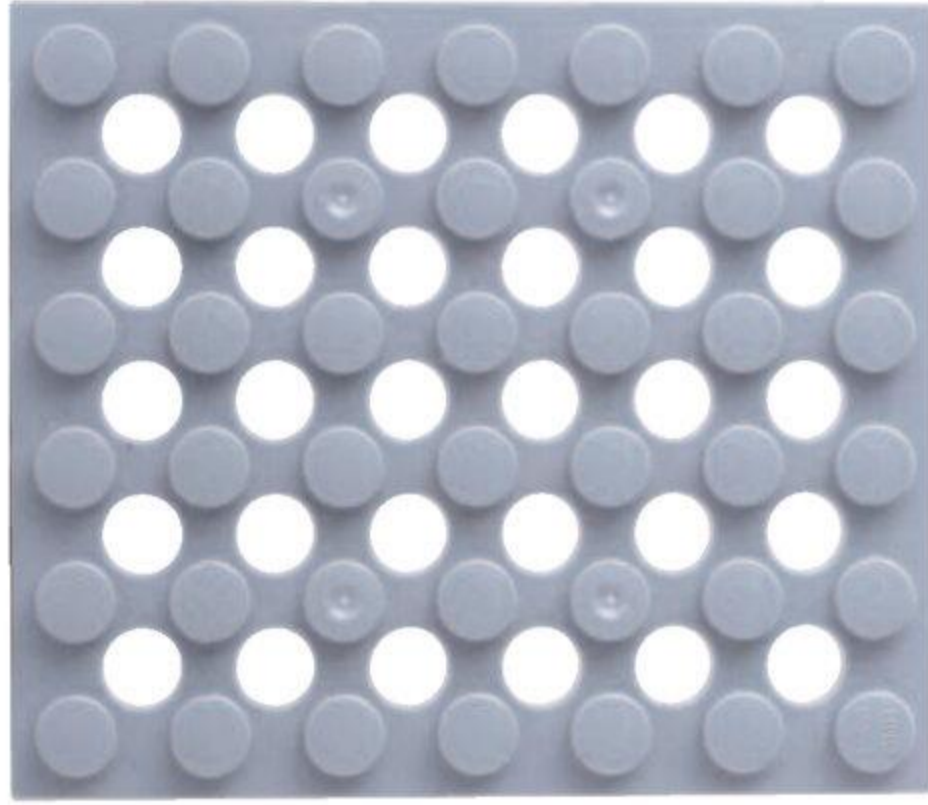

17

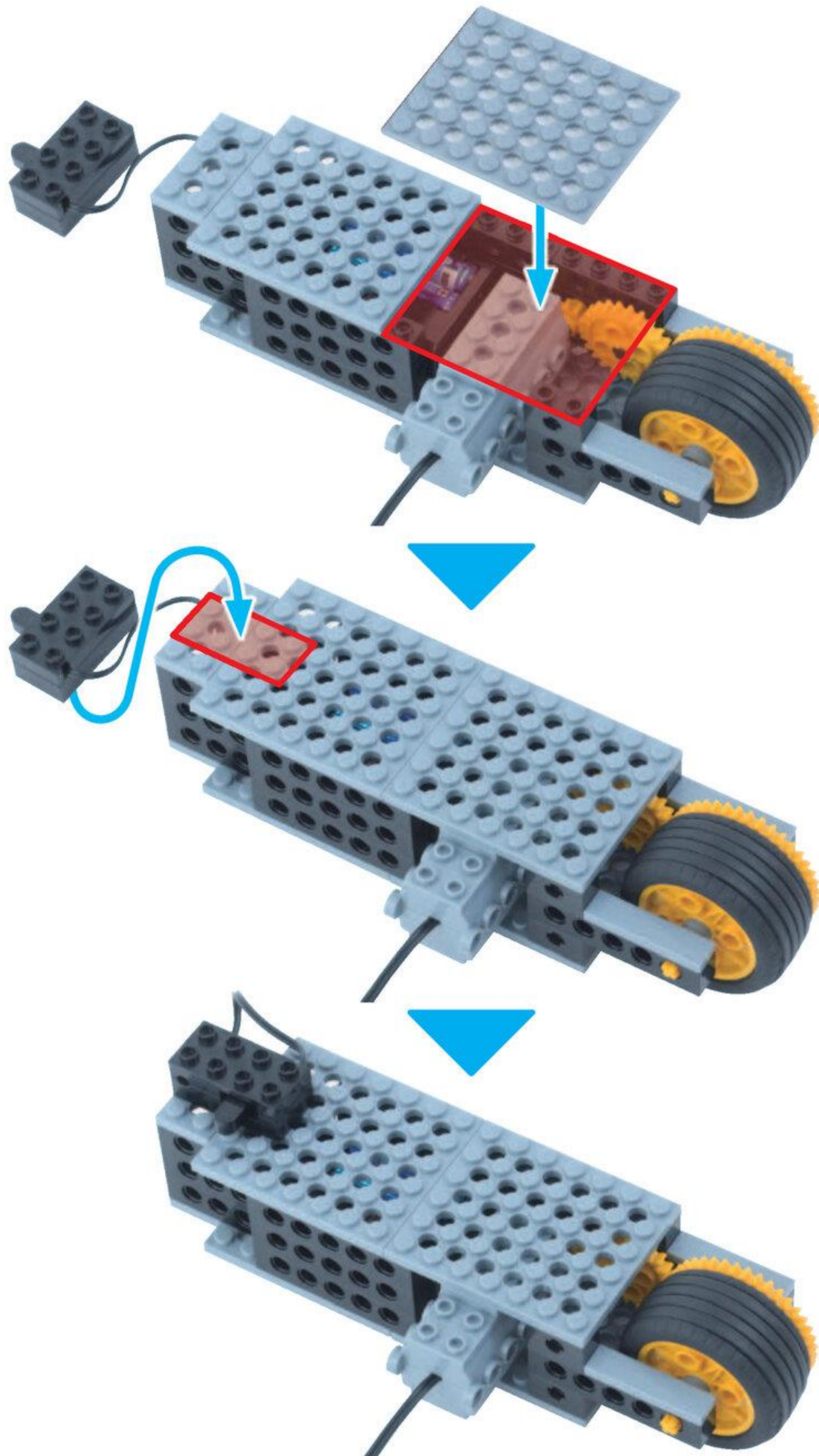

ぎあえむ
ギア M うす 2 こ

しゃふとぺぐ
シャフトペグ 2 こ

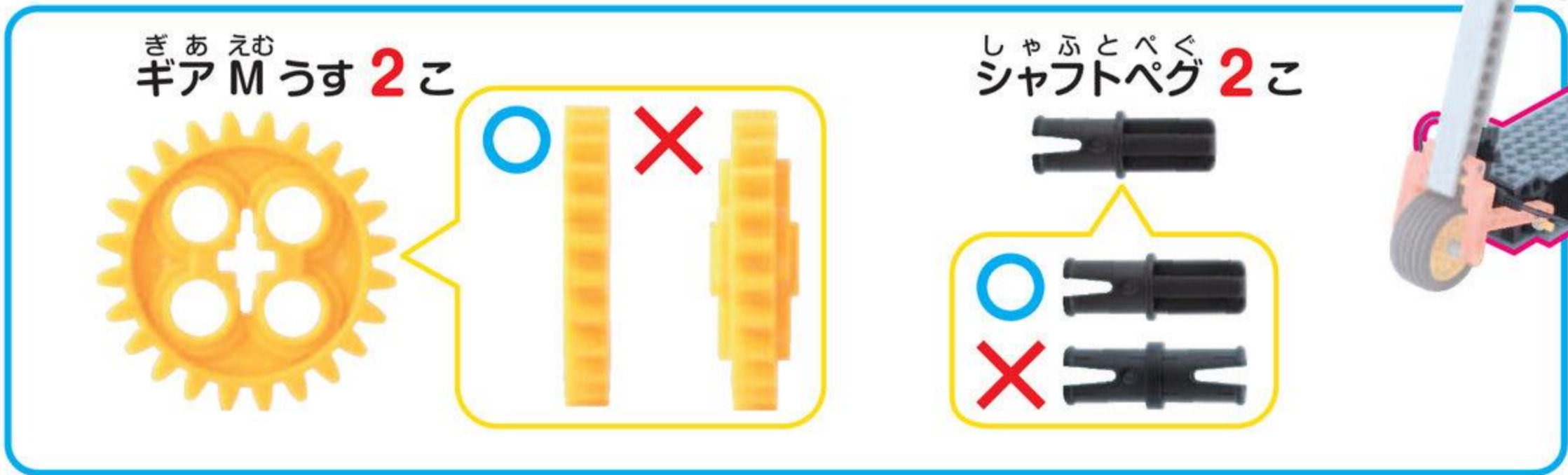

18



19

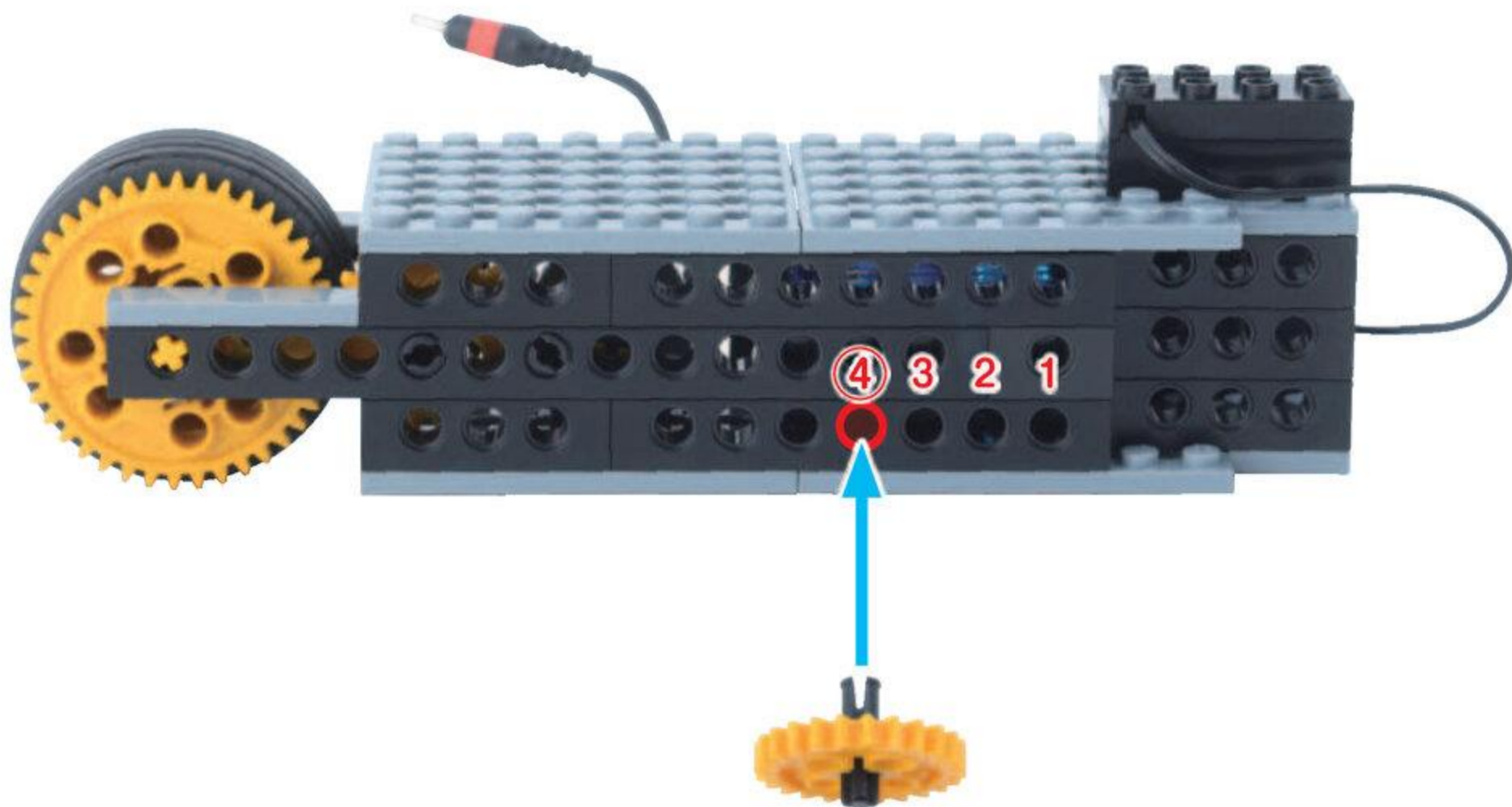

20

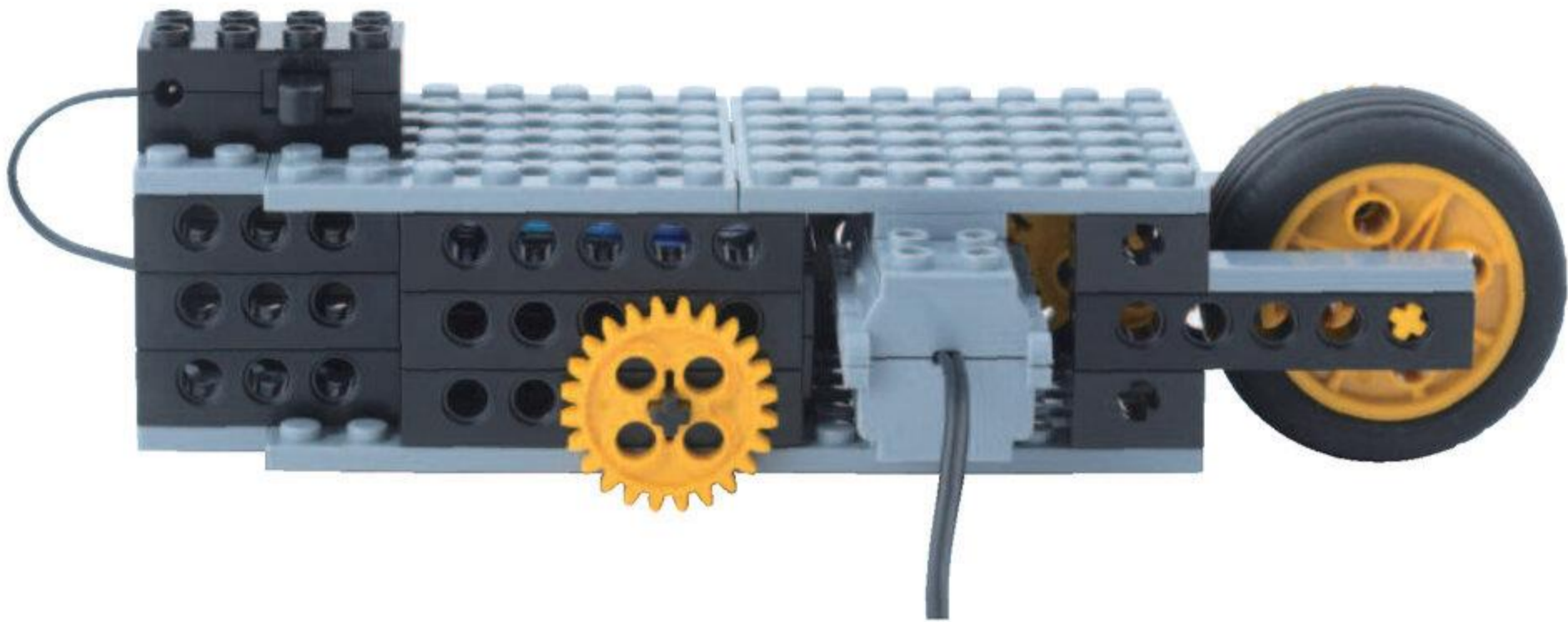
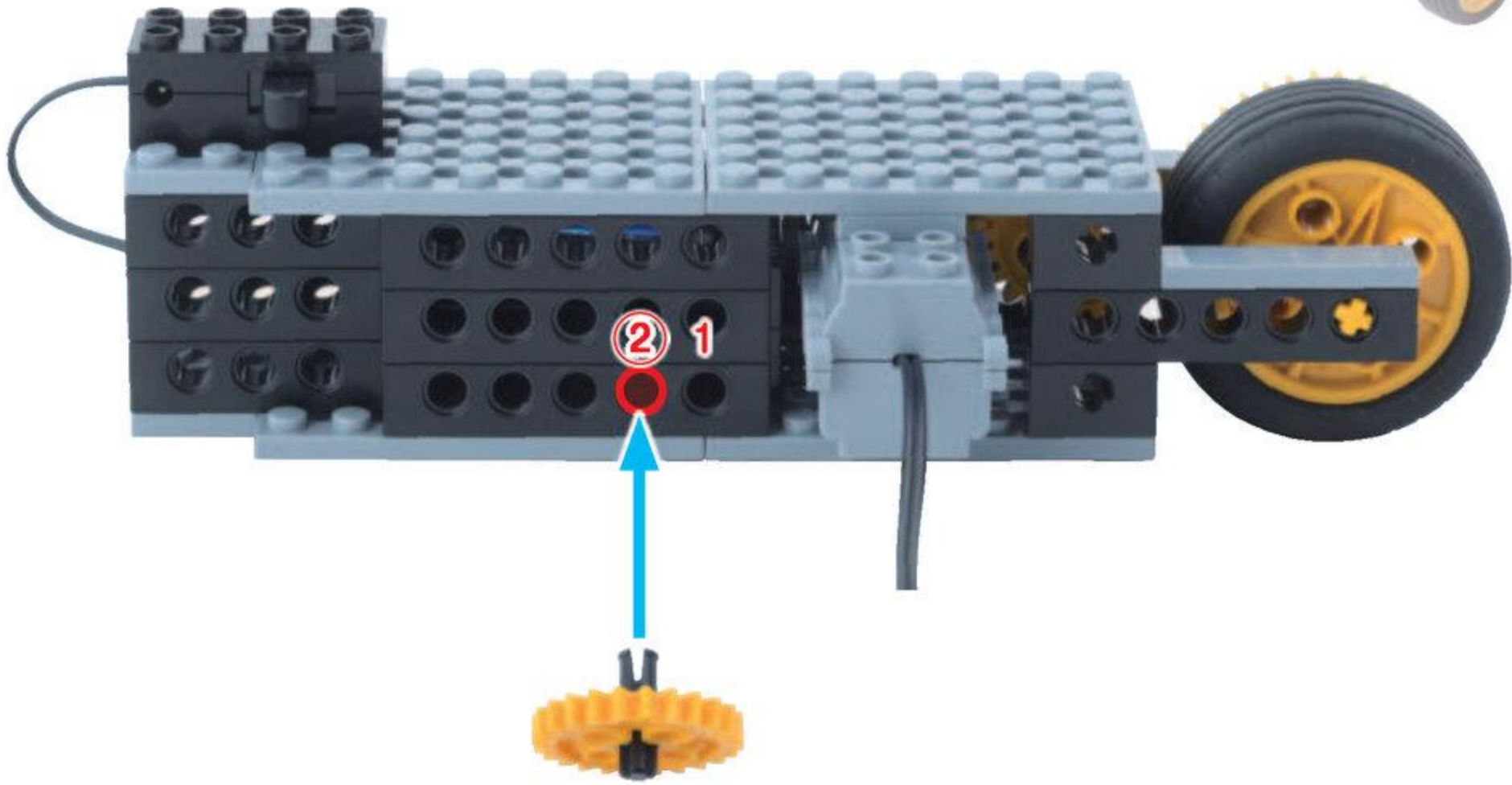

ほおど
ボードが
かんせい!

やったね!

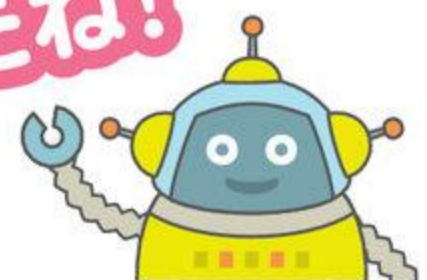

ろぼっと
ロボットを うごかそう

めやす 5 ぶん

こおど
コードをつなごう

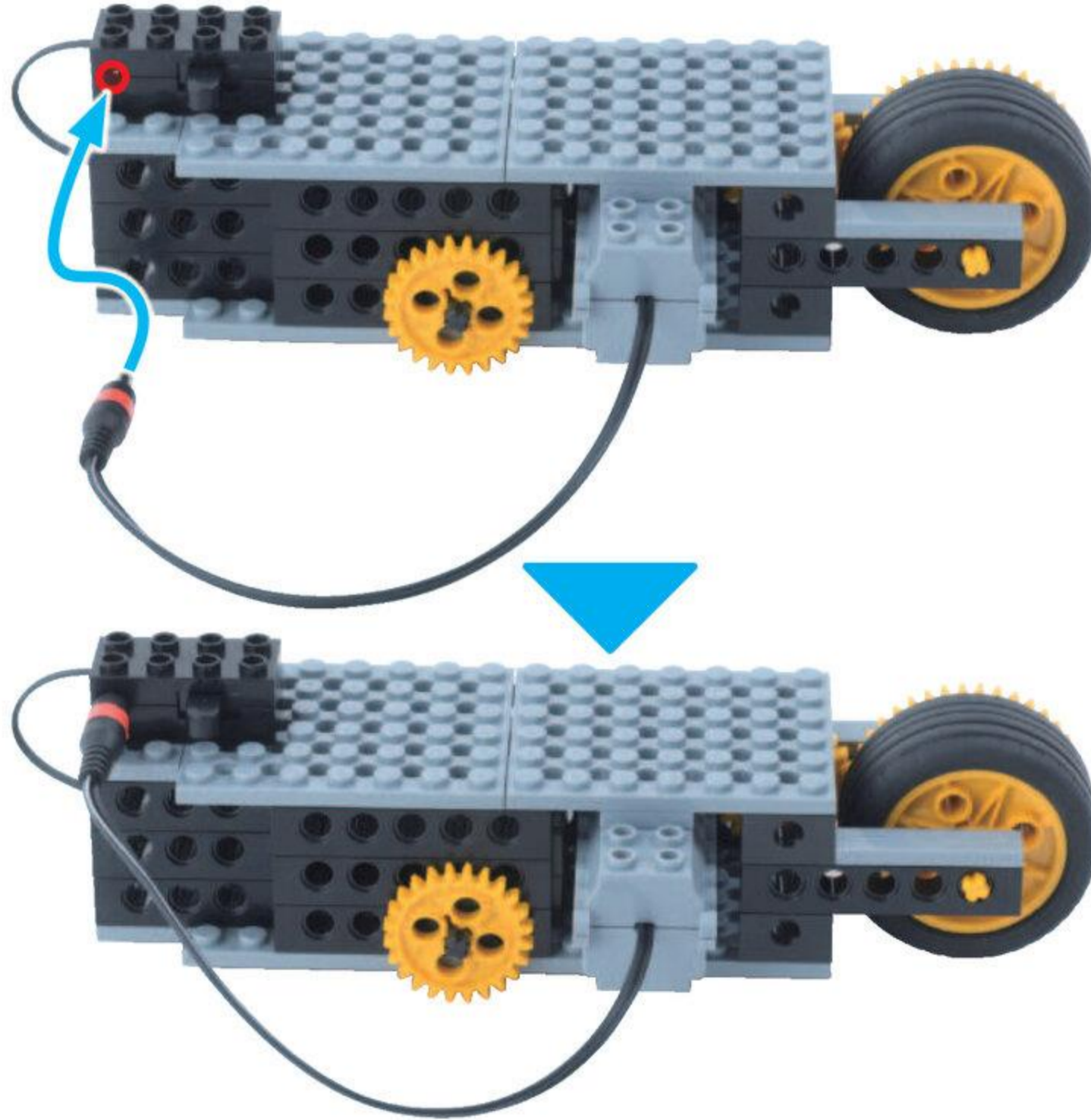

すいっち
スイッチをいれて うごかそう

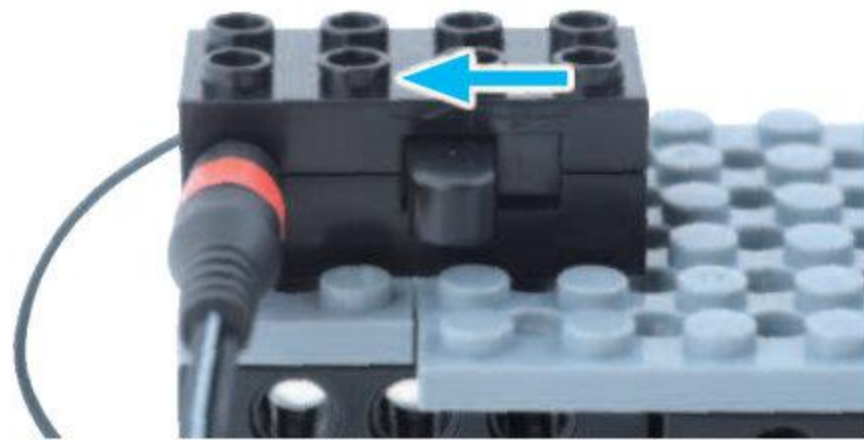

ろぼっと
ロボットは
まえに
すすんだかな？

あとで
はずしておこう

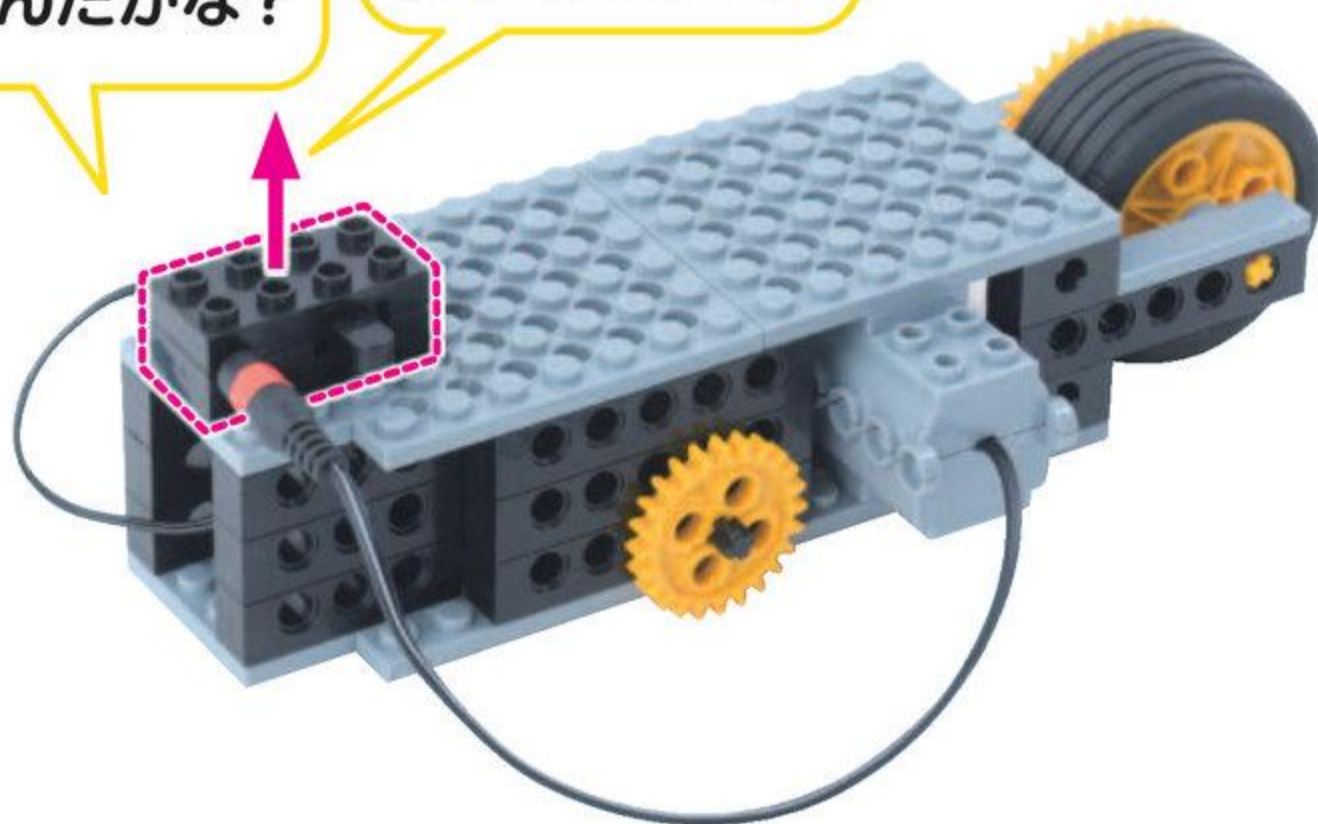

うごかしたら
すいっち
スイッチを もどして
こおど
コードを めいておこう。



すいっち
スイッチを
ほおど
ボードから
はずしておこう。



2

は ん ど る
ハンドル

めやす 10 ぶん

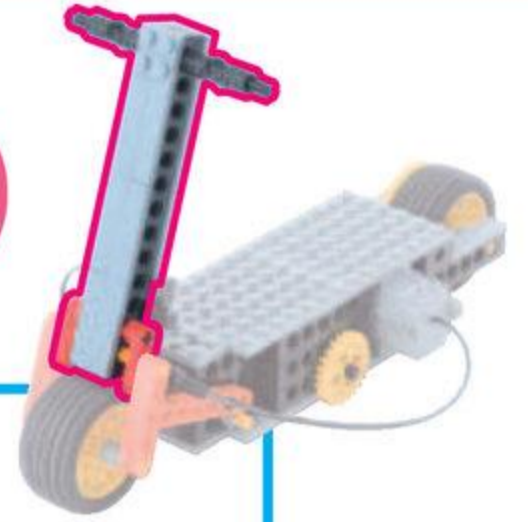

び い む し ゅ う よ ん ぼ ち
ビーム 14 ポチ 2 こ



ふ と ぶ れ え と る く ぼ ち
太プレート 6 ポチ 1 こ



ふ と ぶ れ え と よ ん ぼ ち
太プレート 4 ポチ 1 こ



1

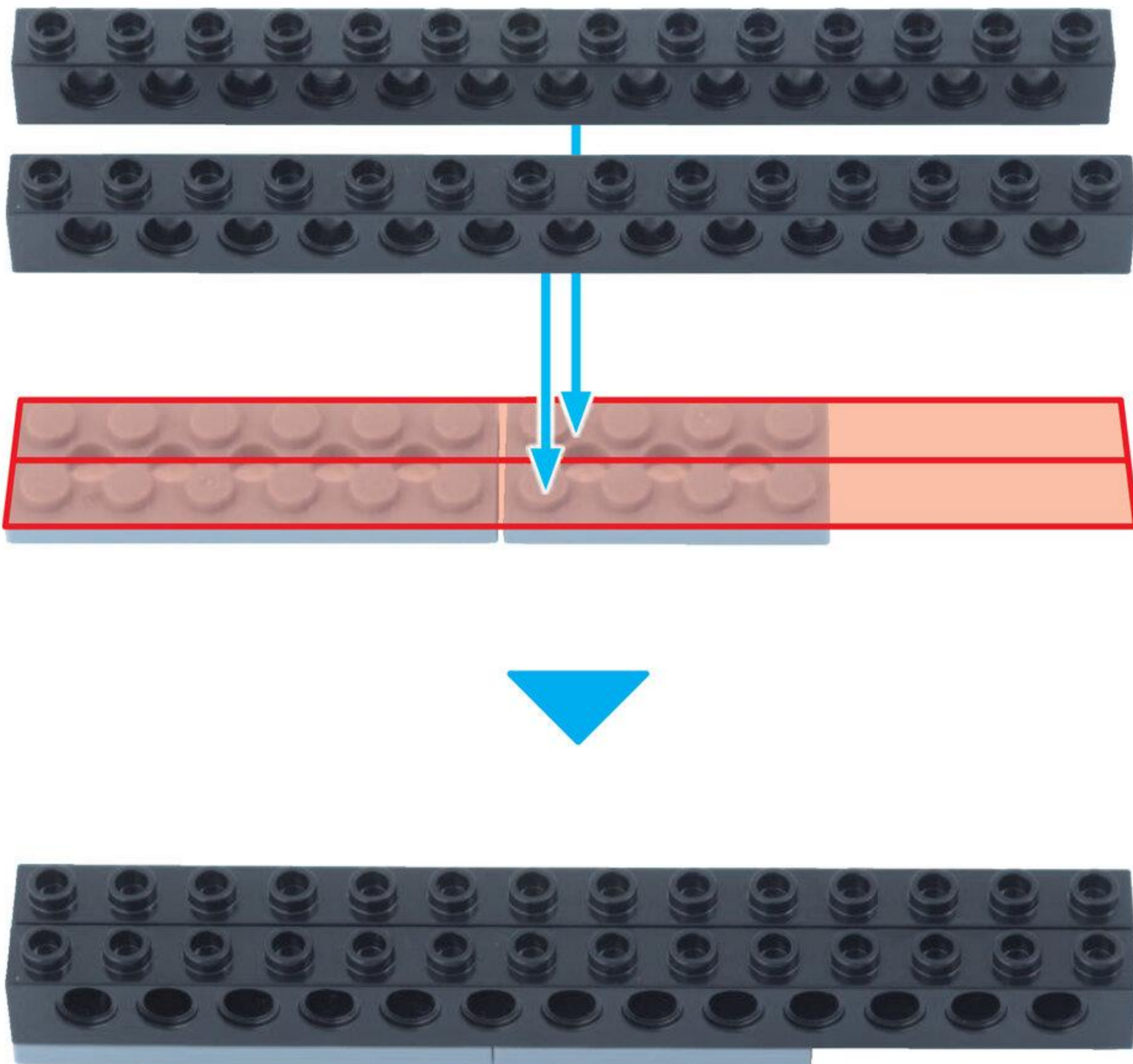

ほそぶれえとにほち
細プレート2ポチ **2**こ



たいる
タイル **6**こ

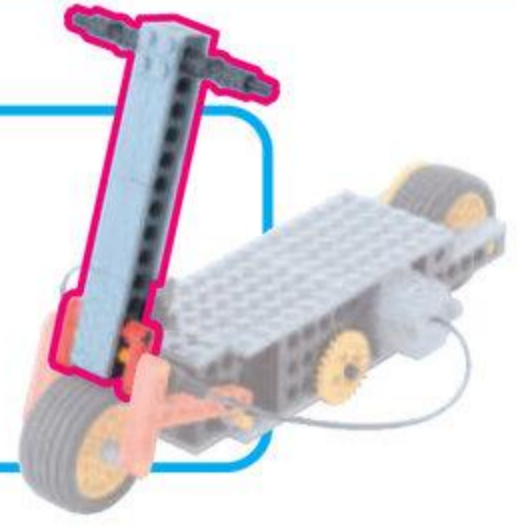

2

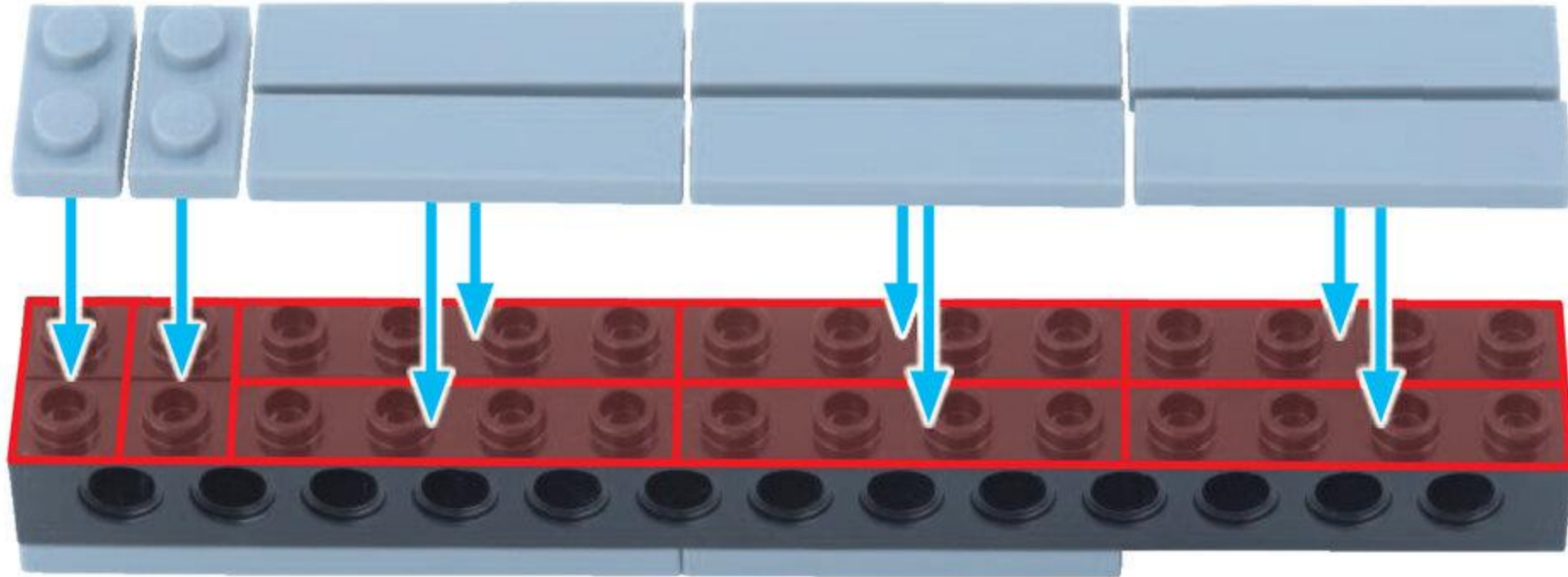

あなしゃふとじょいんと
アナシャフトジョイント 2こ



くろしゃふとにぼち
黒シャフト2ポチ 2こ



ながい



みじかい

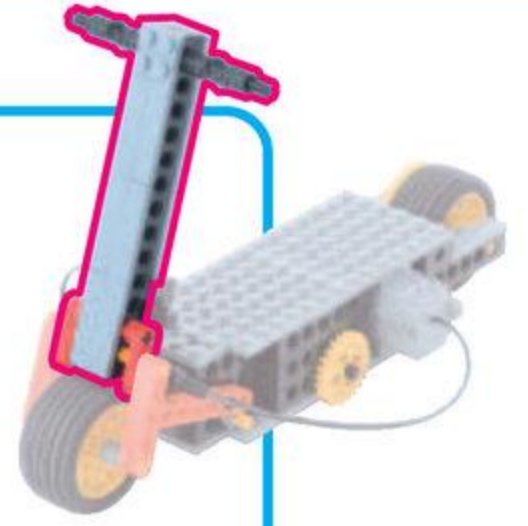

3



シャフト 4ポチ 1こ

ながさに
ちゅうい

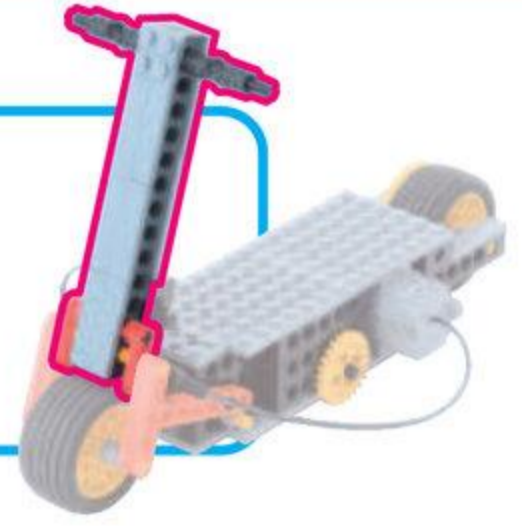

4

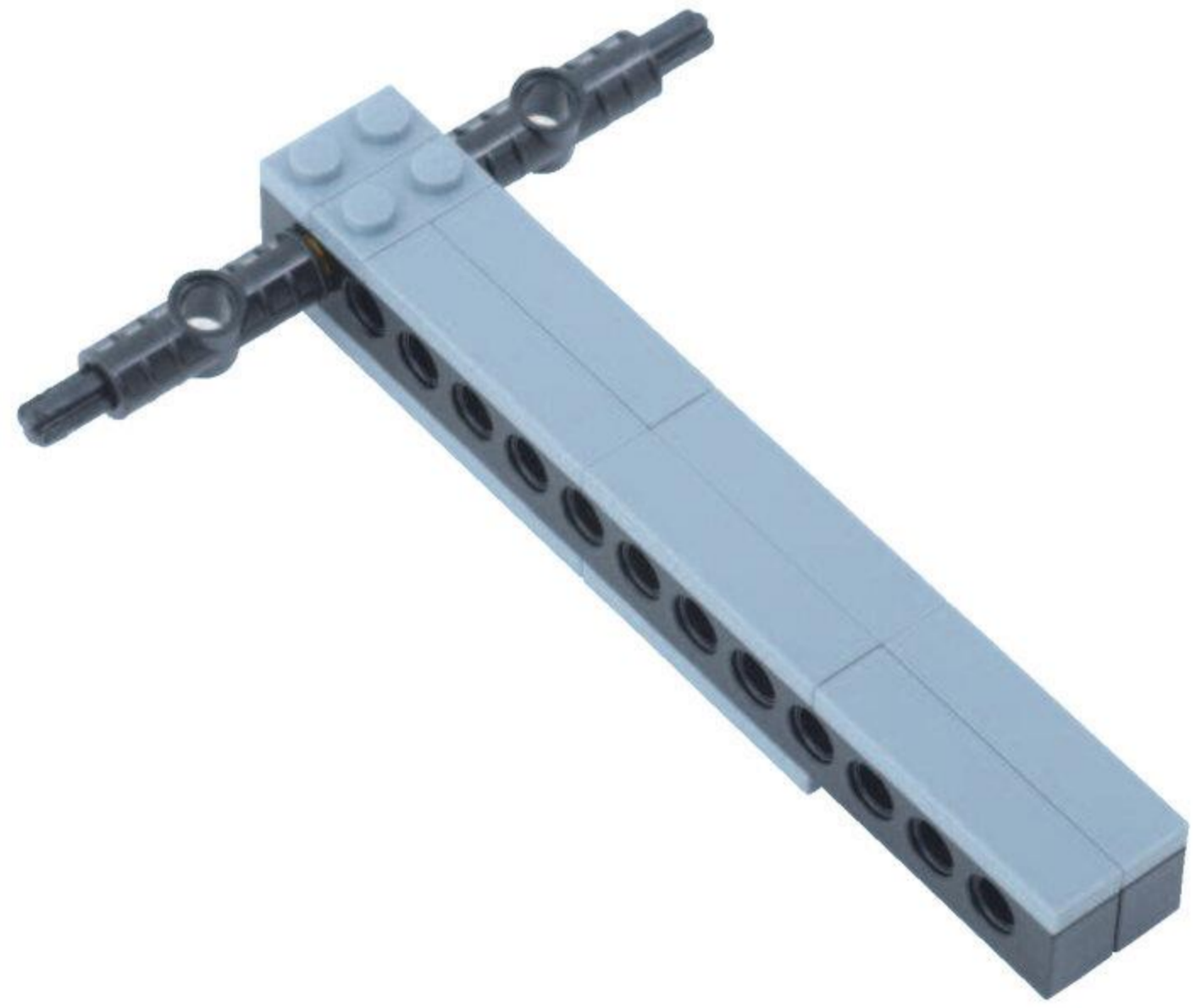
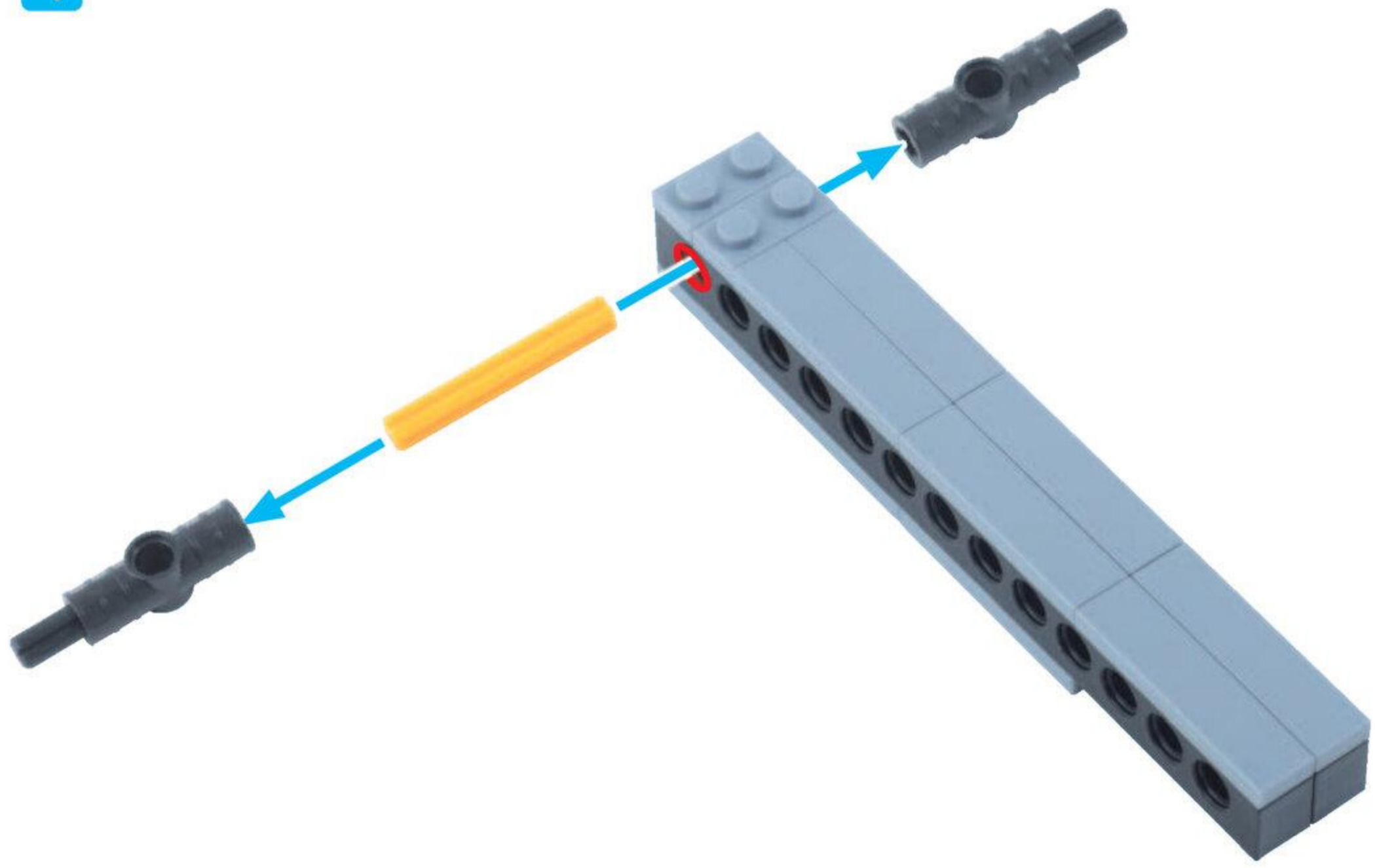

くらんく 2こ
クランク 2こ

しゃふとpeg 2こ
シャフトpeg 2こ

しゃふと6ポチ
シャフト6ポチ 1こ

ながさに
ちゅうい

5

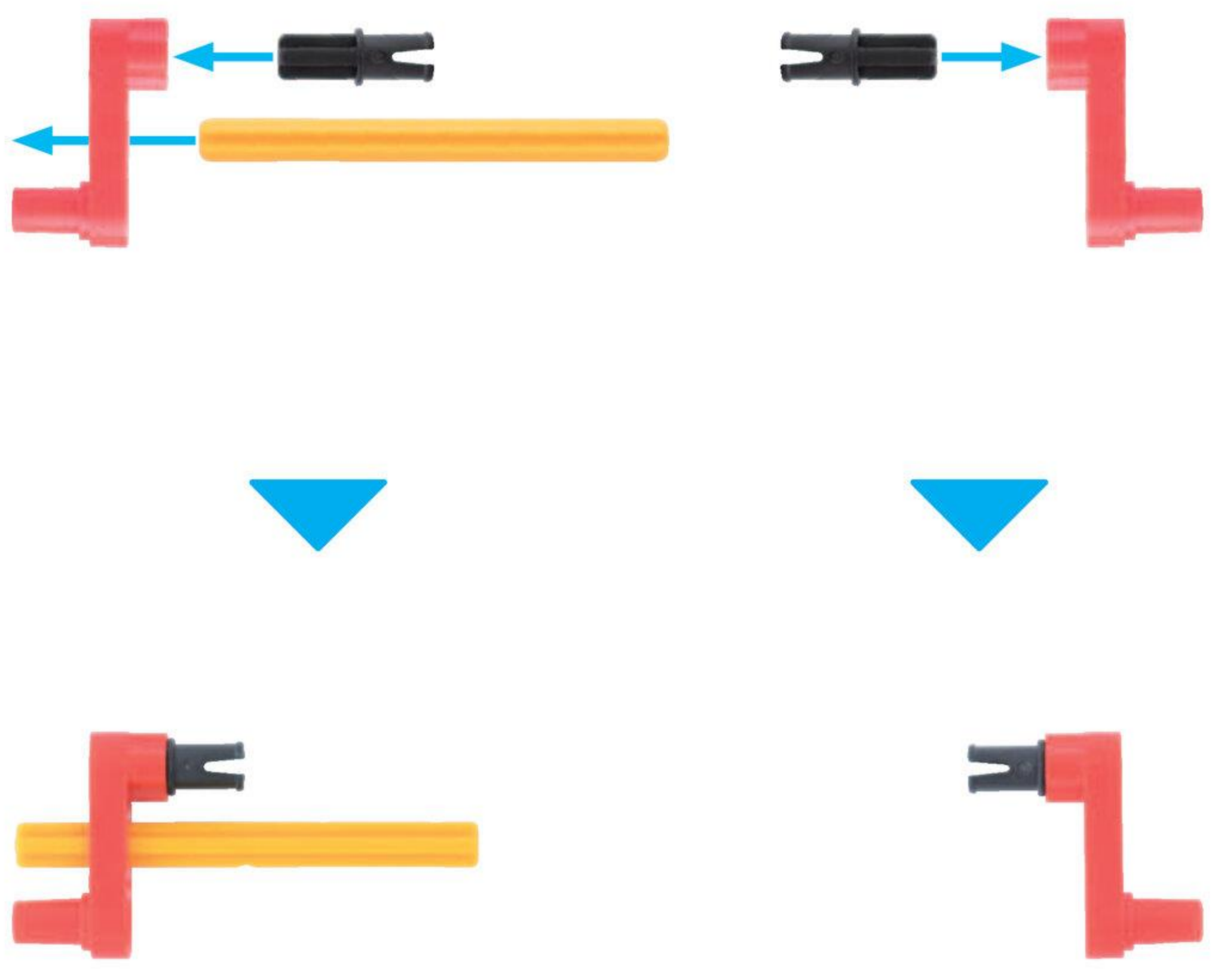

6

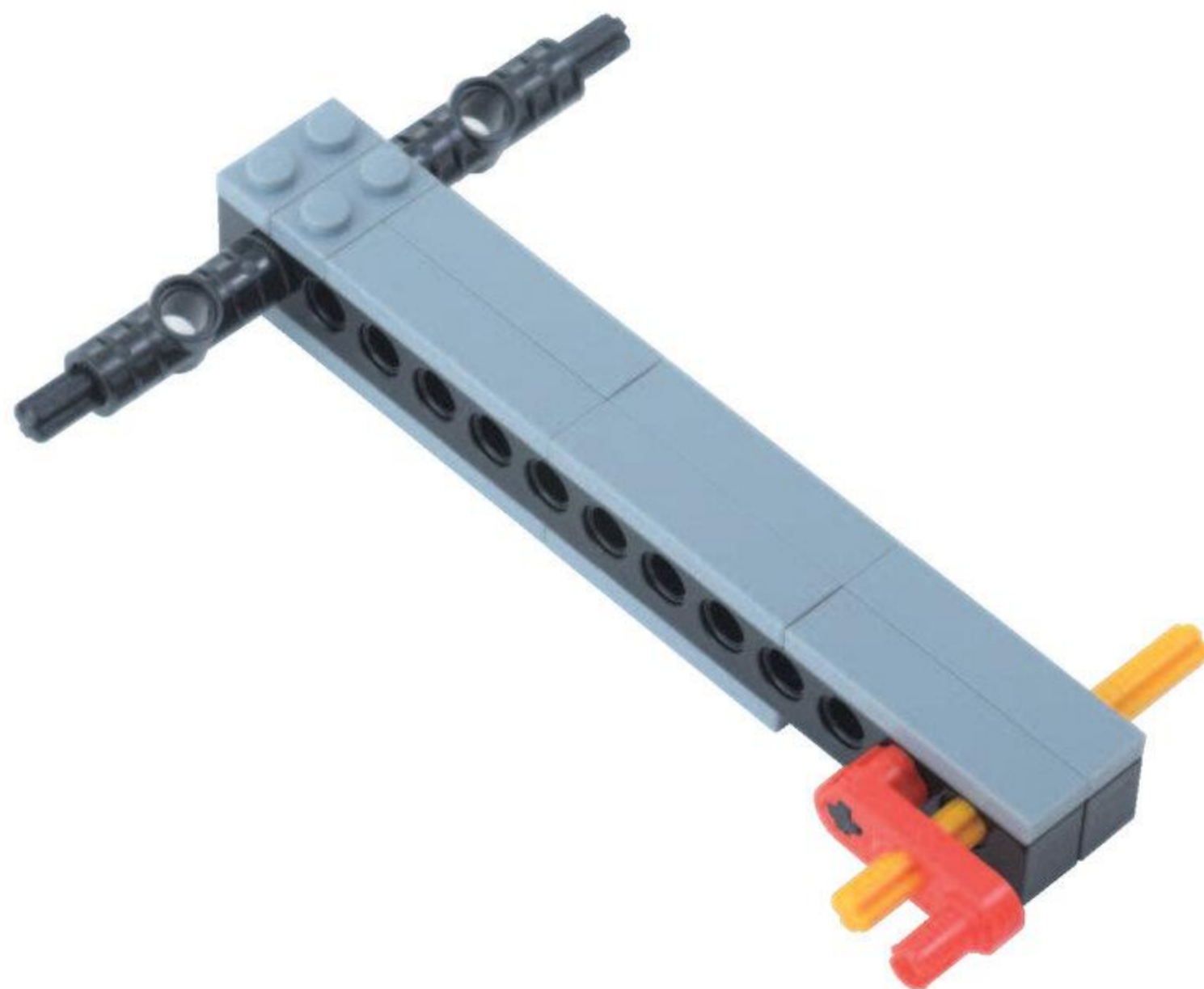
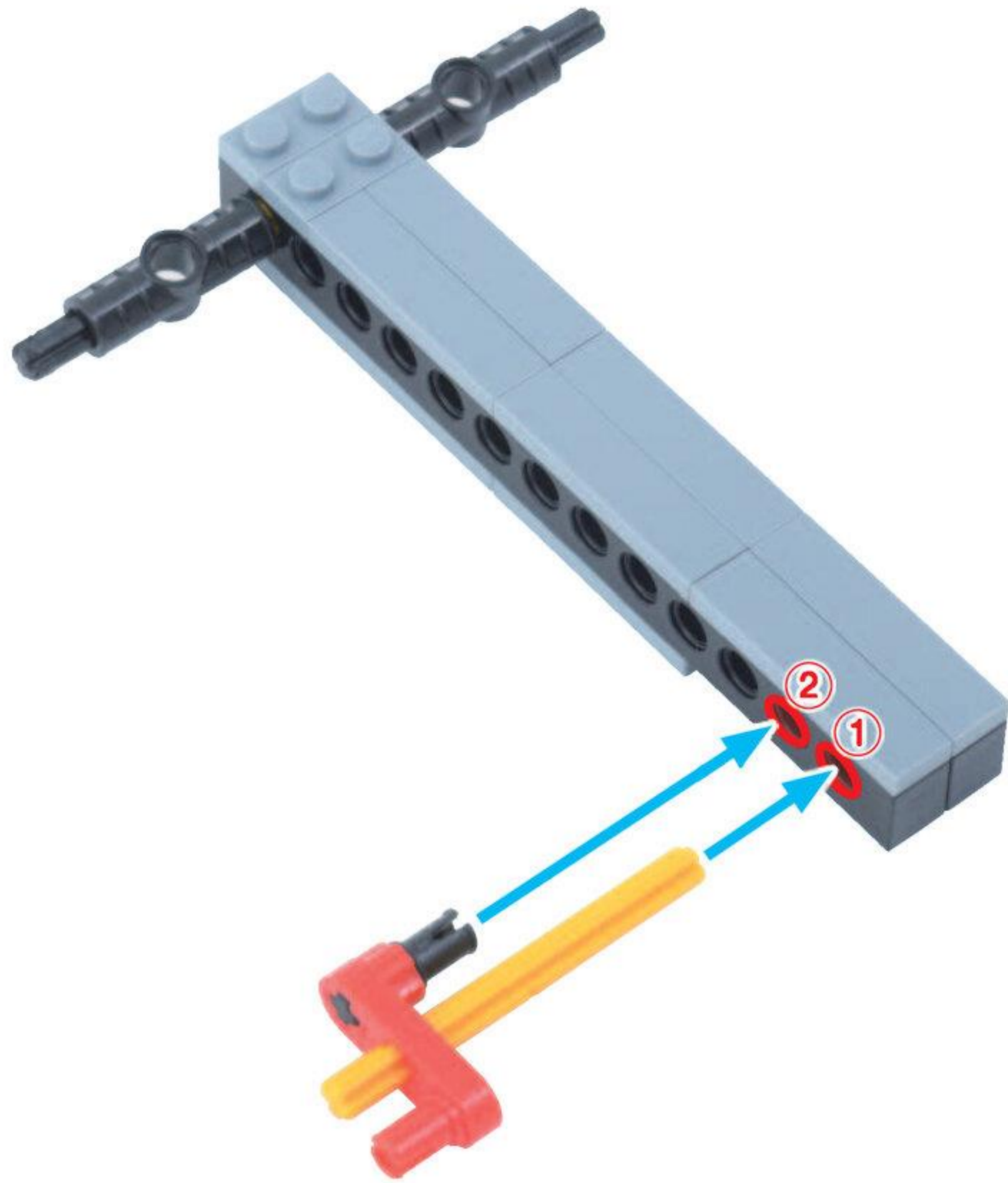

7

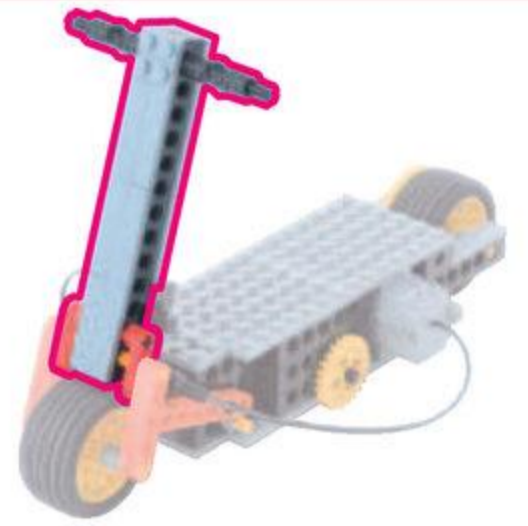
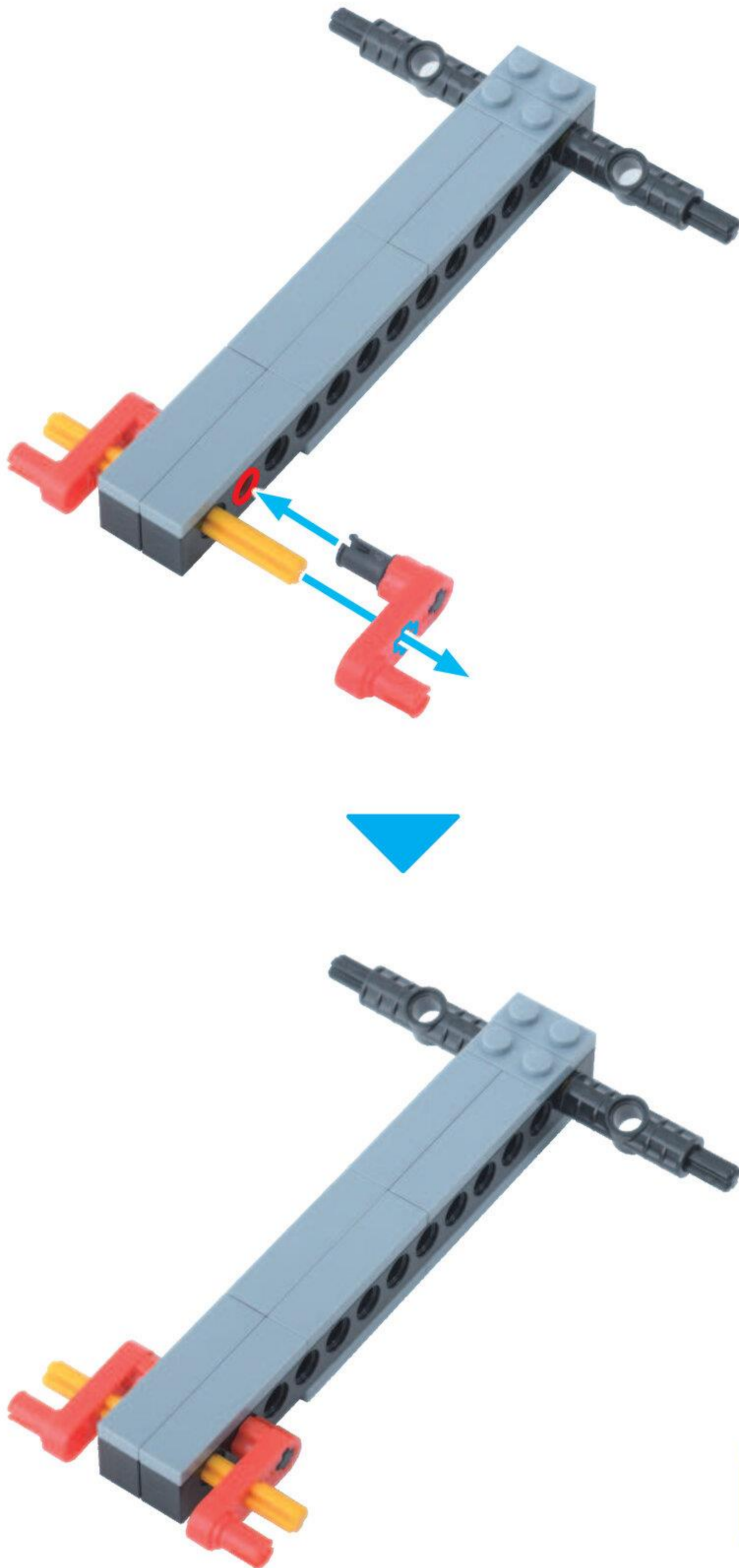

はんだる
ハンドルが
かんせい!

やったね!

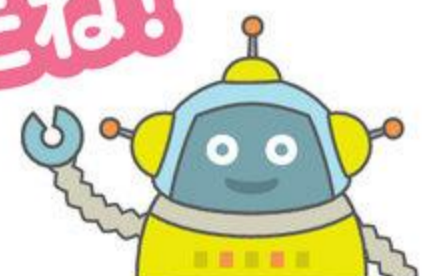

3 ストッパー

めやす 5 ぶん

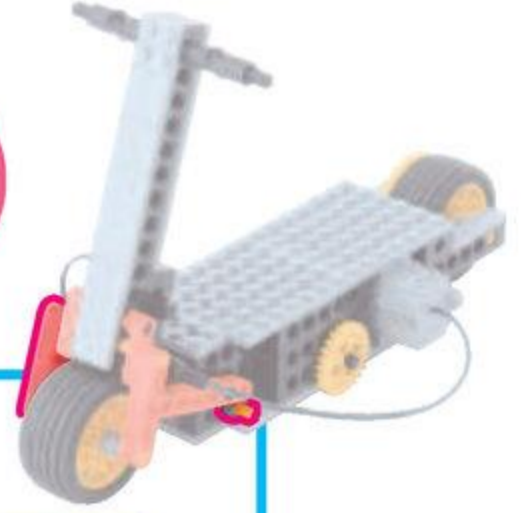

ていじょいんと T ジョイント 1 こ ぶっしゅ ブッシュ 1 こ しゃふと 6 ぽち シャフト 6 ポチ 1 こ

ぺぐ S 1 こ

ながさにちゅうい

1

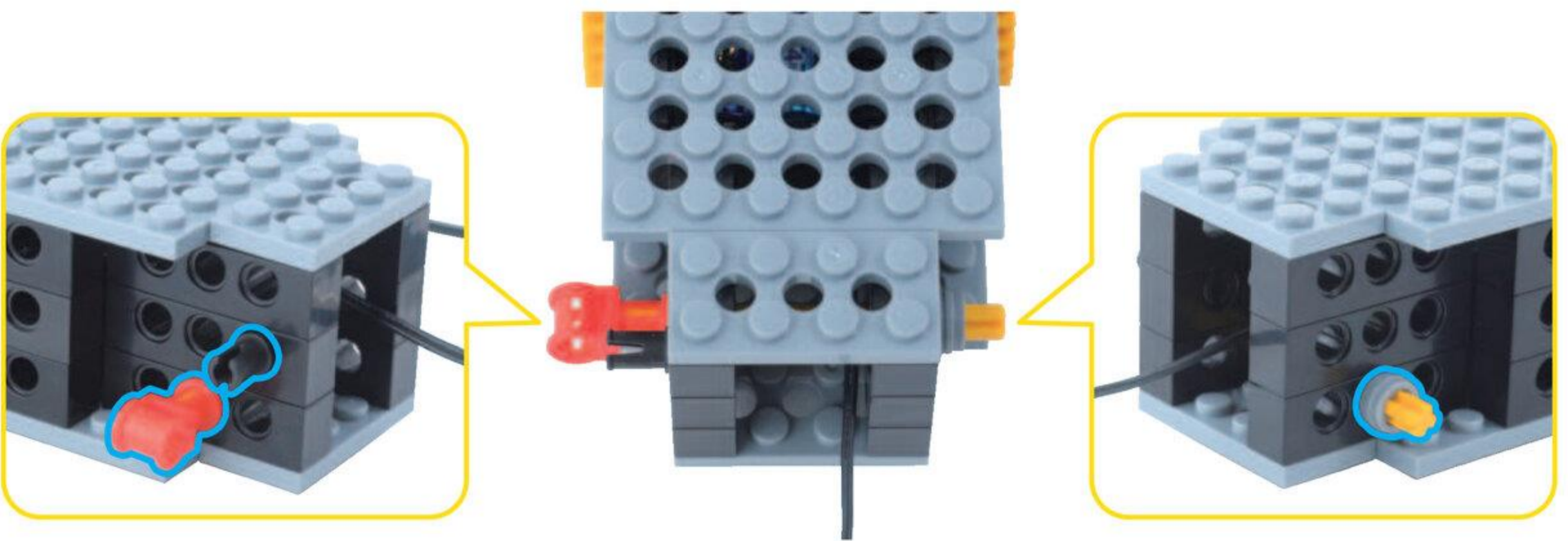
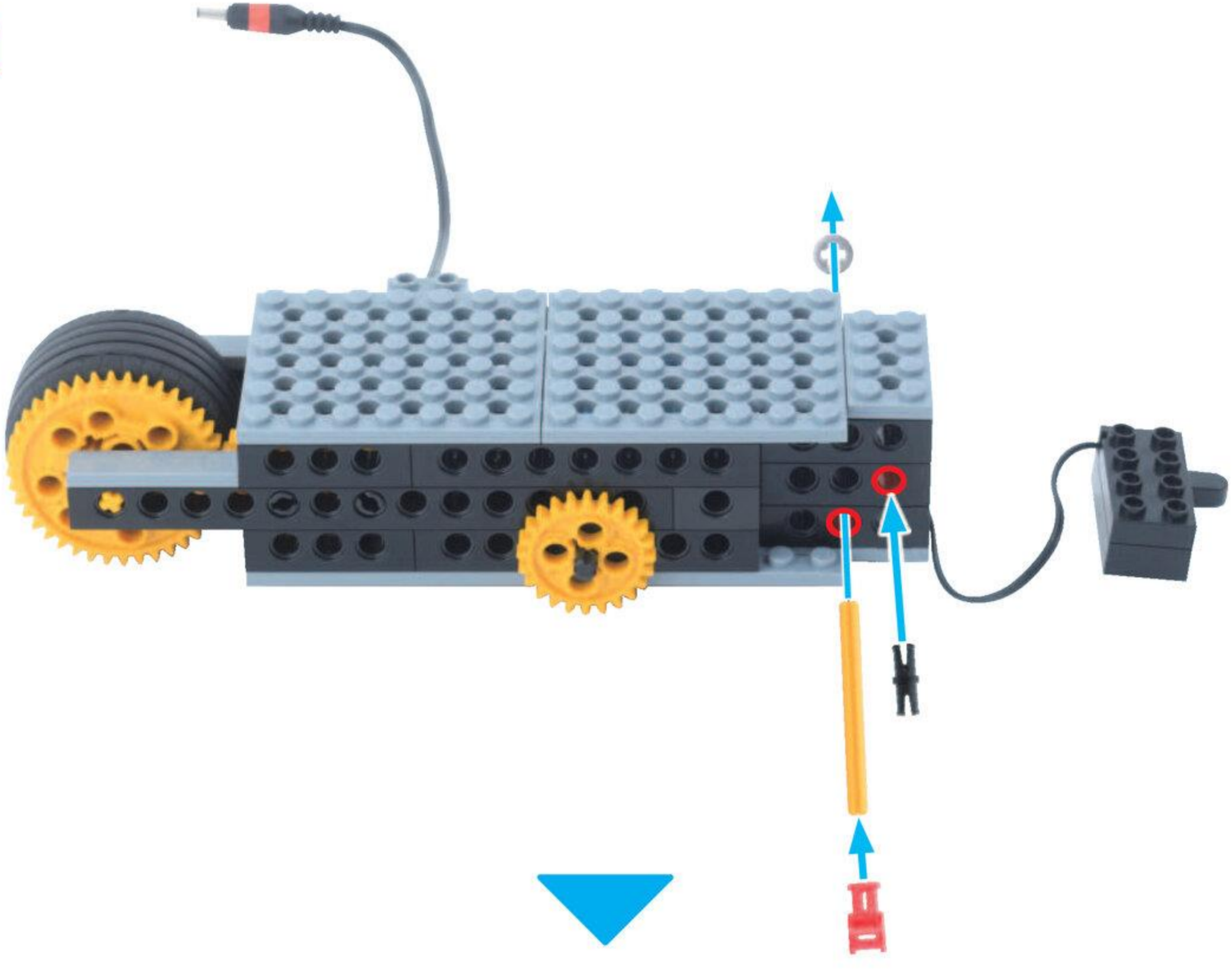

てい ろっど
T ロッド 1こ

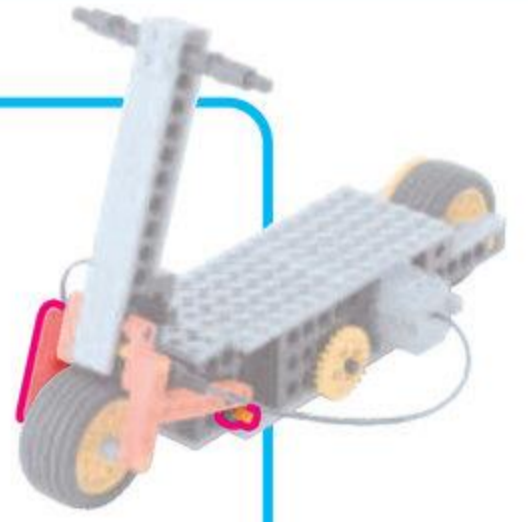
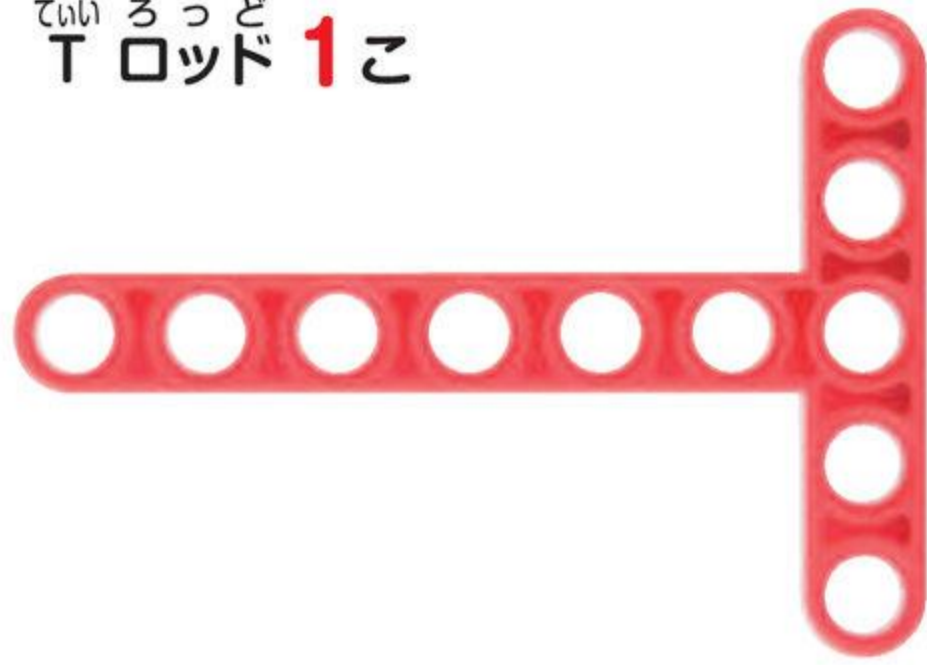

2

は んどる
ハンドルの
むきに
ちゅうい



3

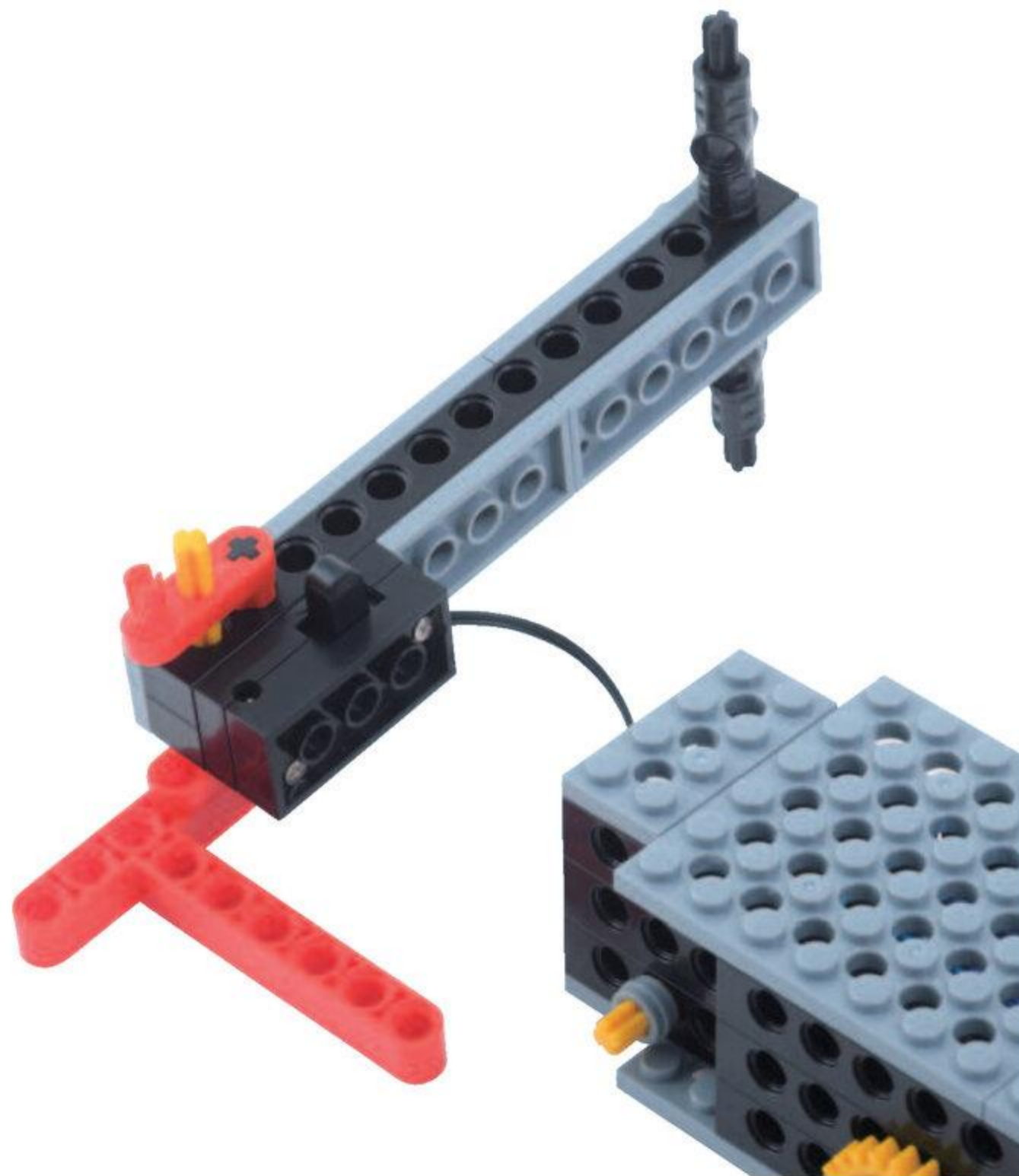
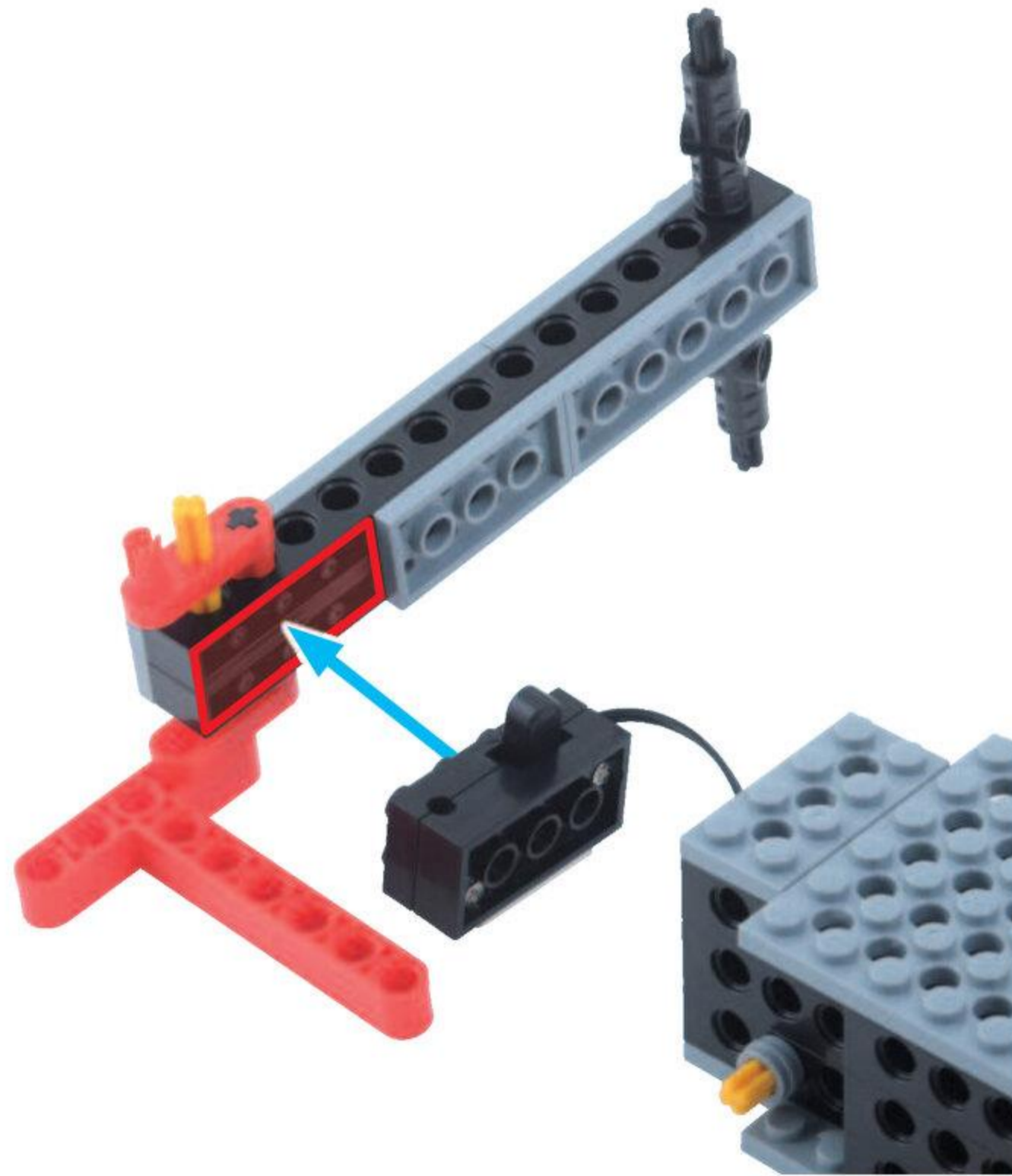

4

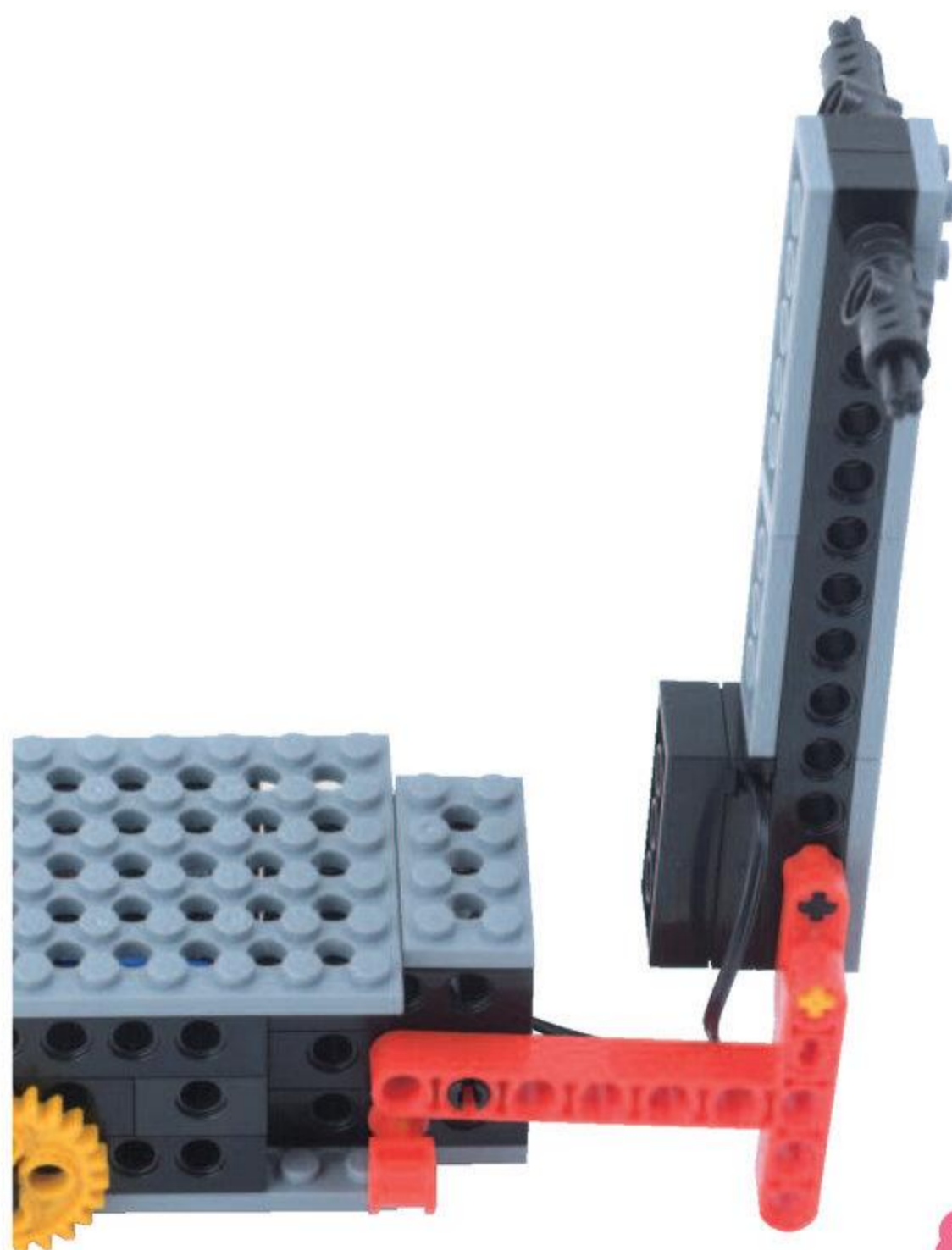
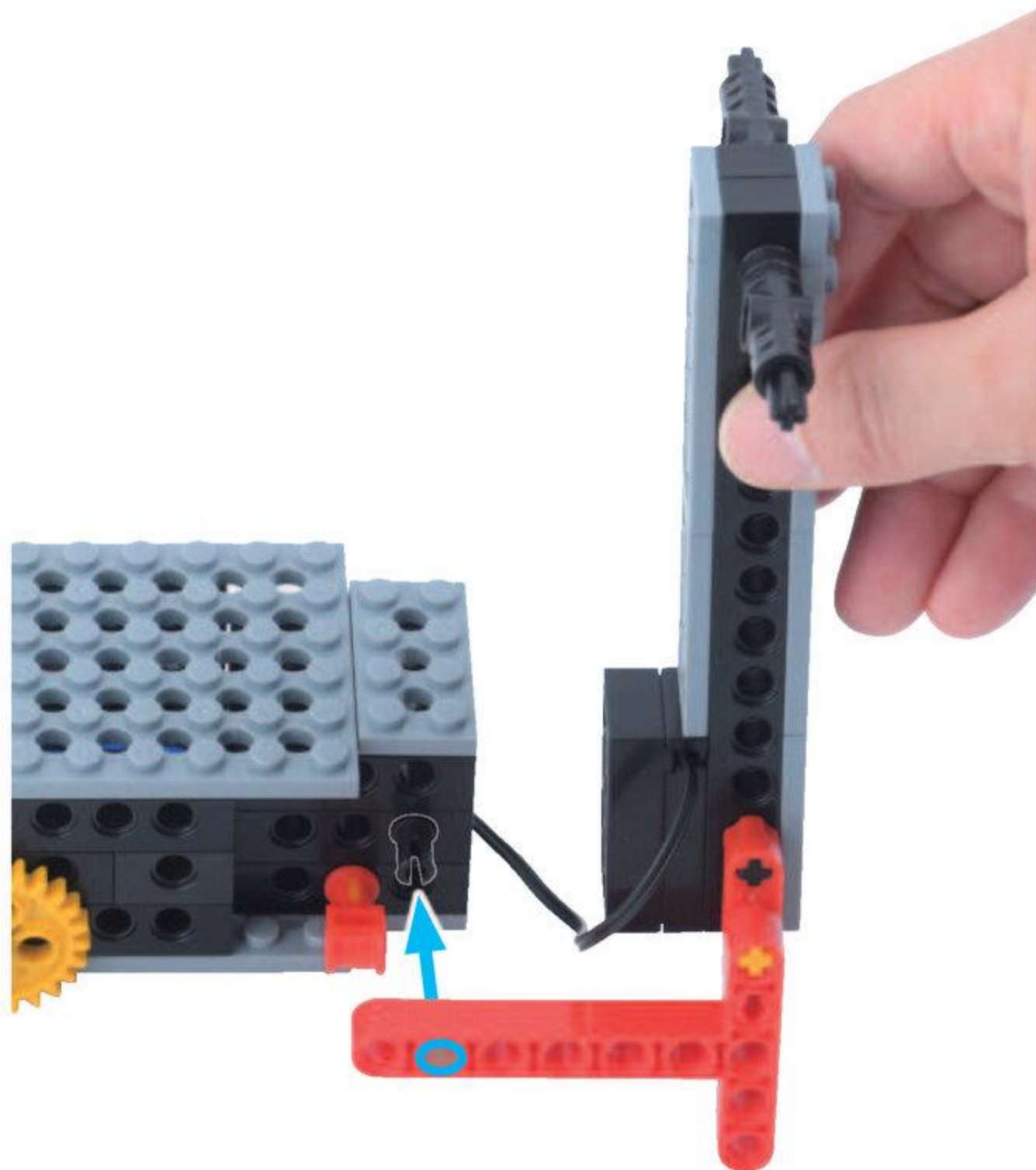

す と っ ぽ あ
ス ト ッ パ ー が
か ん せ い !

や っ た ね !

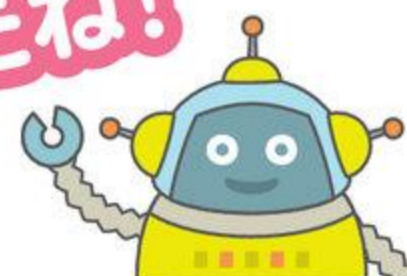

4

ぜんりん

めやす 5 ふん

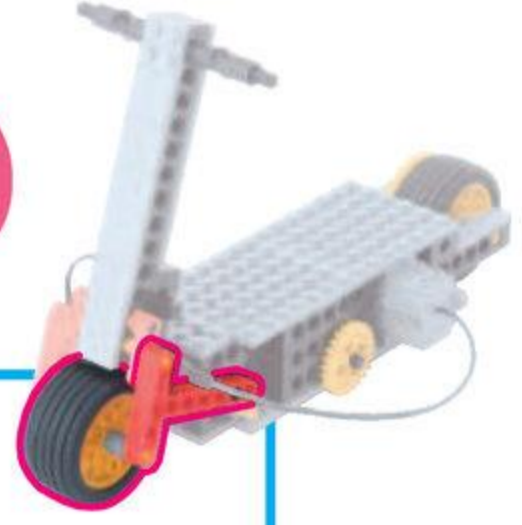

たいや^ろ 1こ
タイヤ



ぶっしゅ 6こ
ブッシュ



しゃふと^く 6ポチ 1こ
シャフト



ながさに
ちゅうい

1

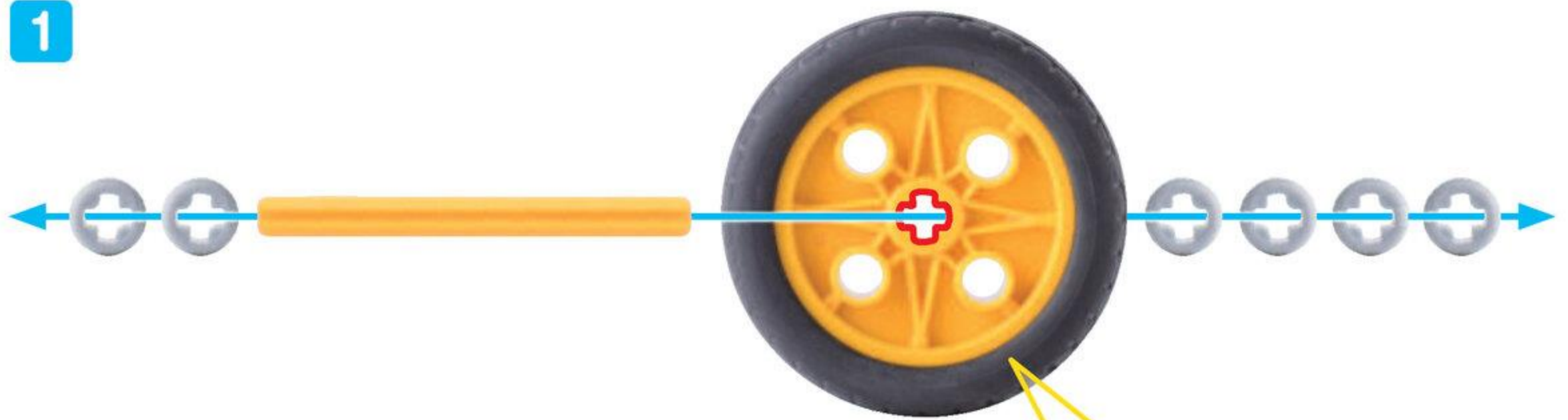

たいや
タイヤの むきに ちゅうい
へこんでいるほうが うら



2

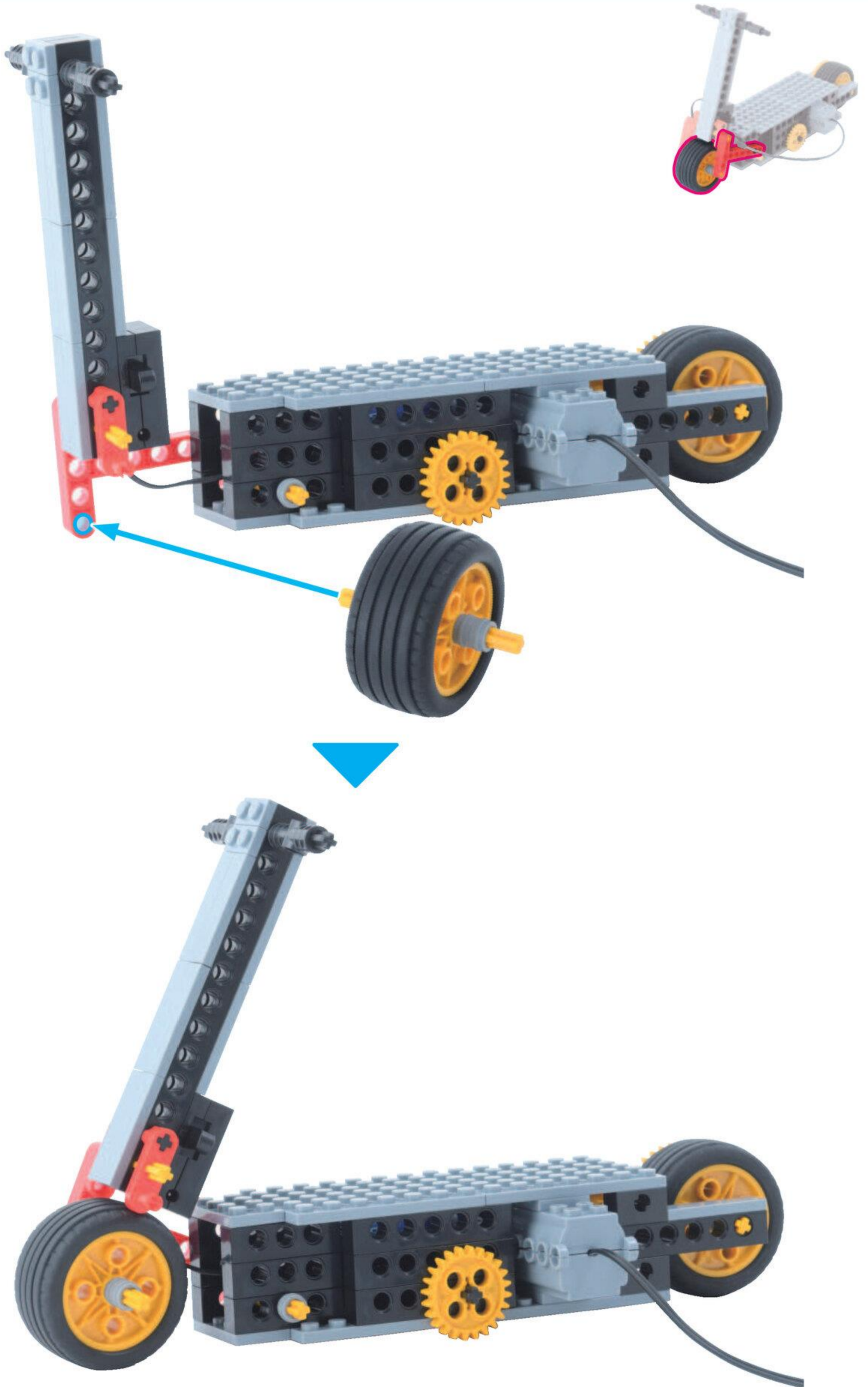

peg 1 piece



1 piece T-rod

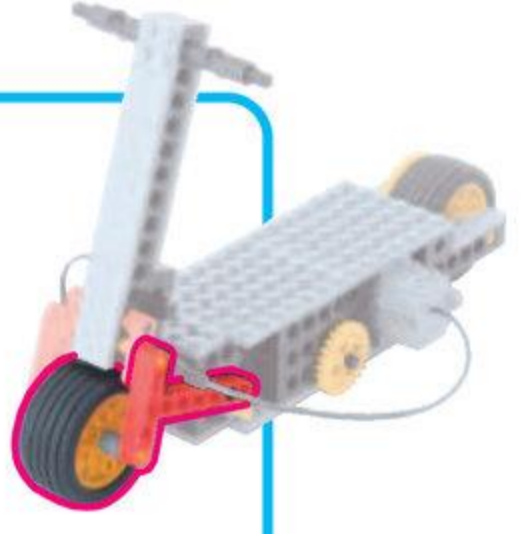
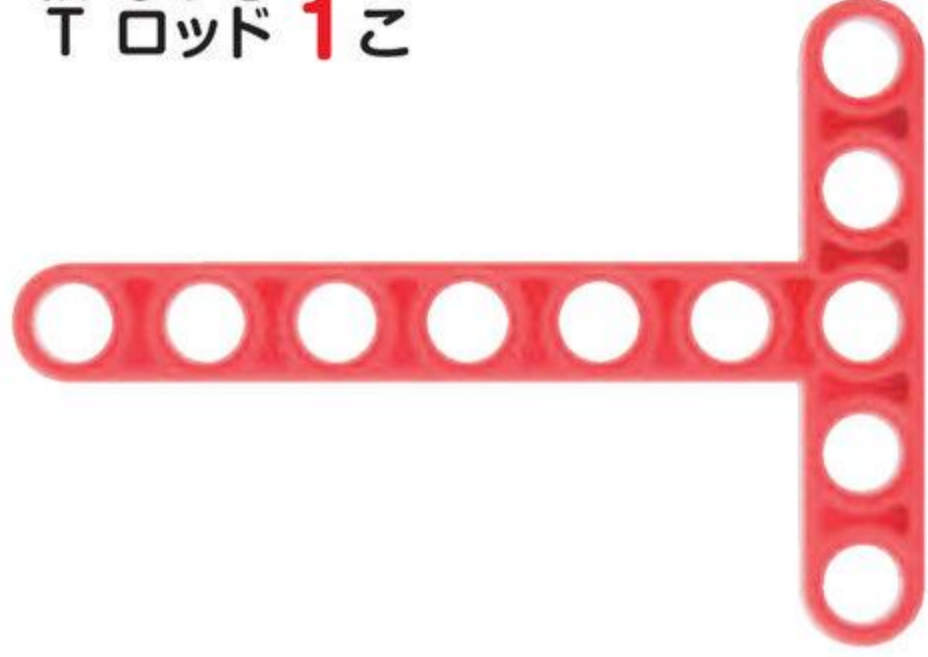

3

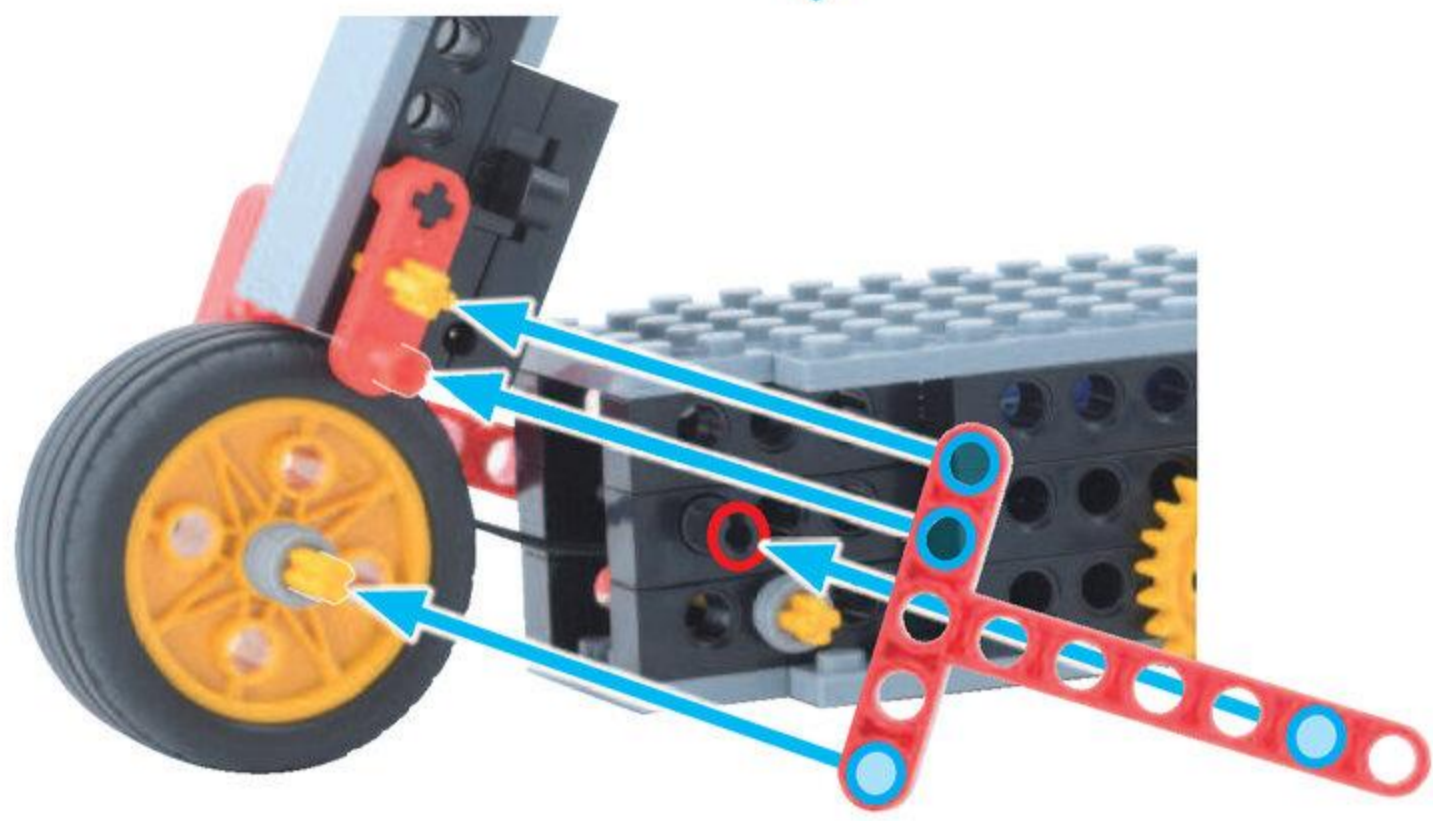
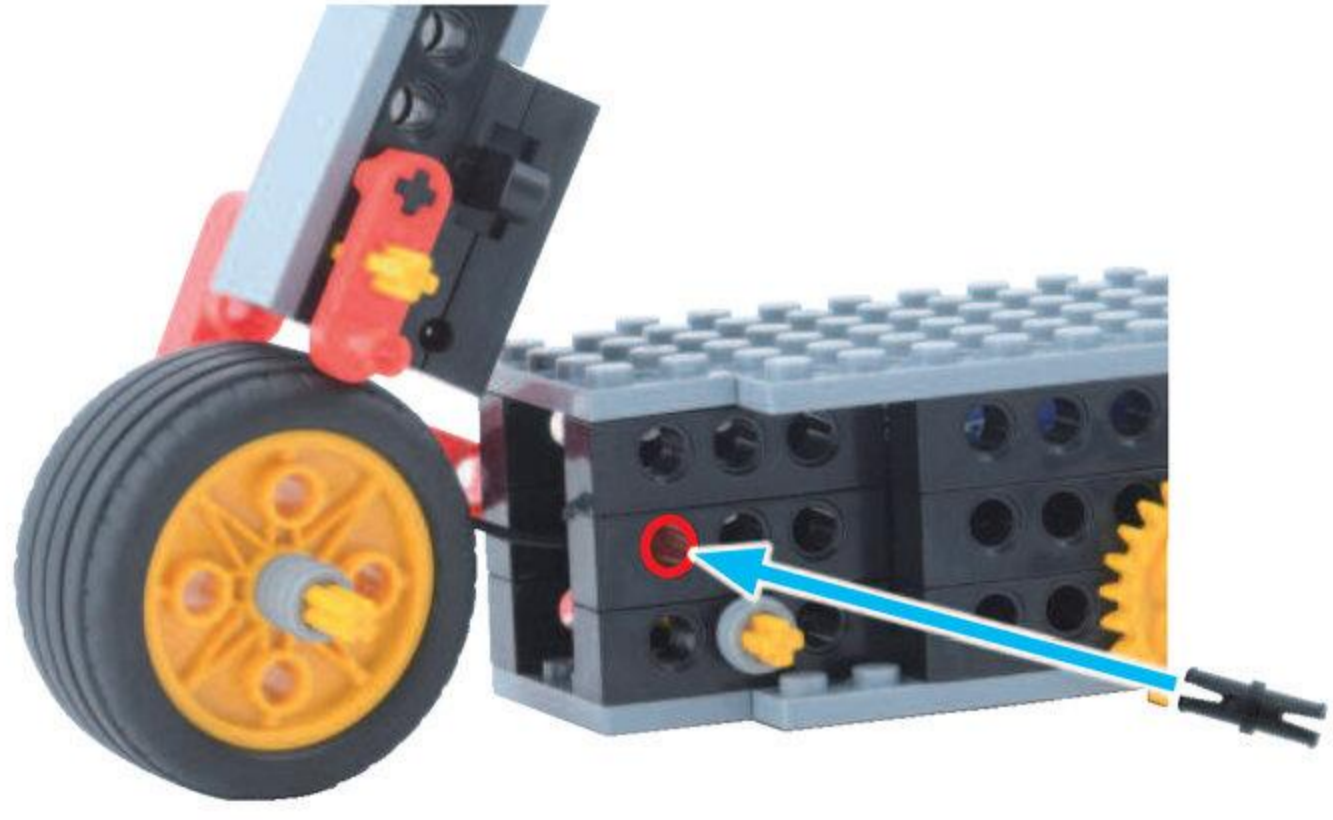

これで
かんせい!

よくできました!

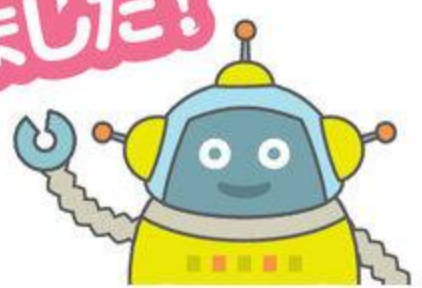

ろぼっと
ロボットを うごかそう

めやす 5 ぶん

こおど
コードをつなごう

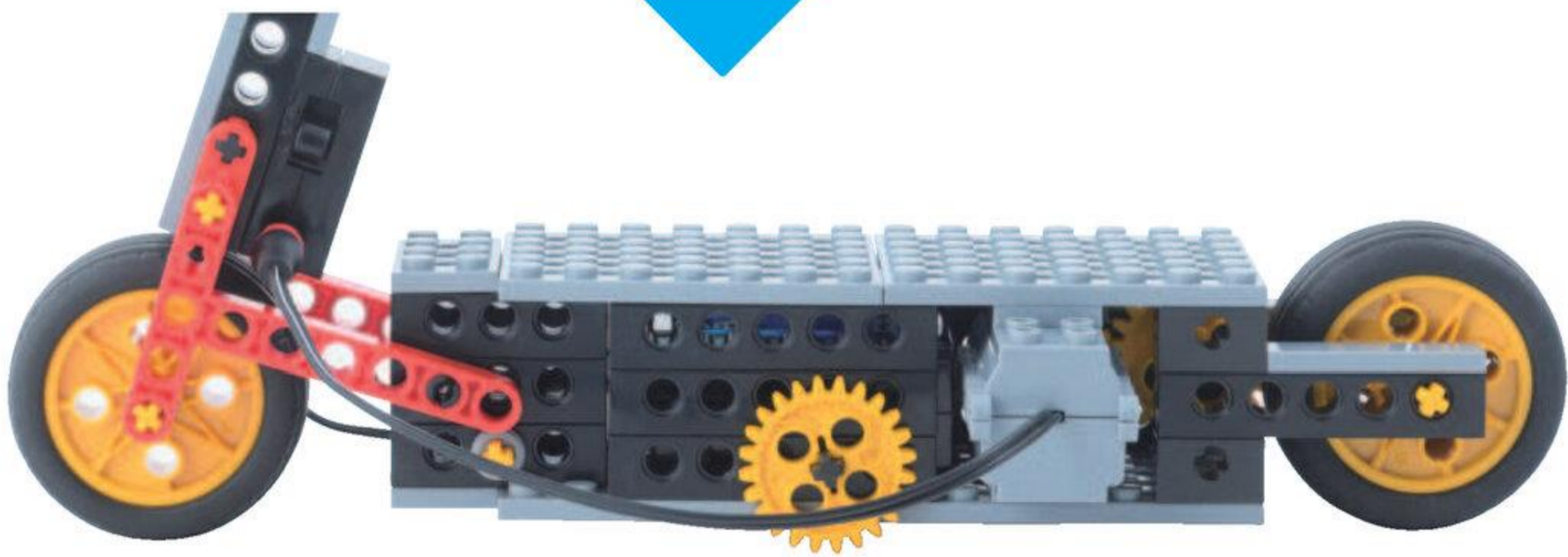
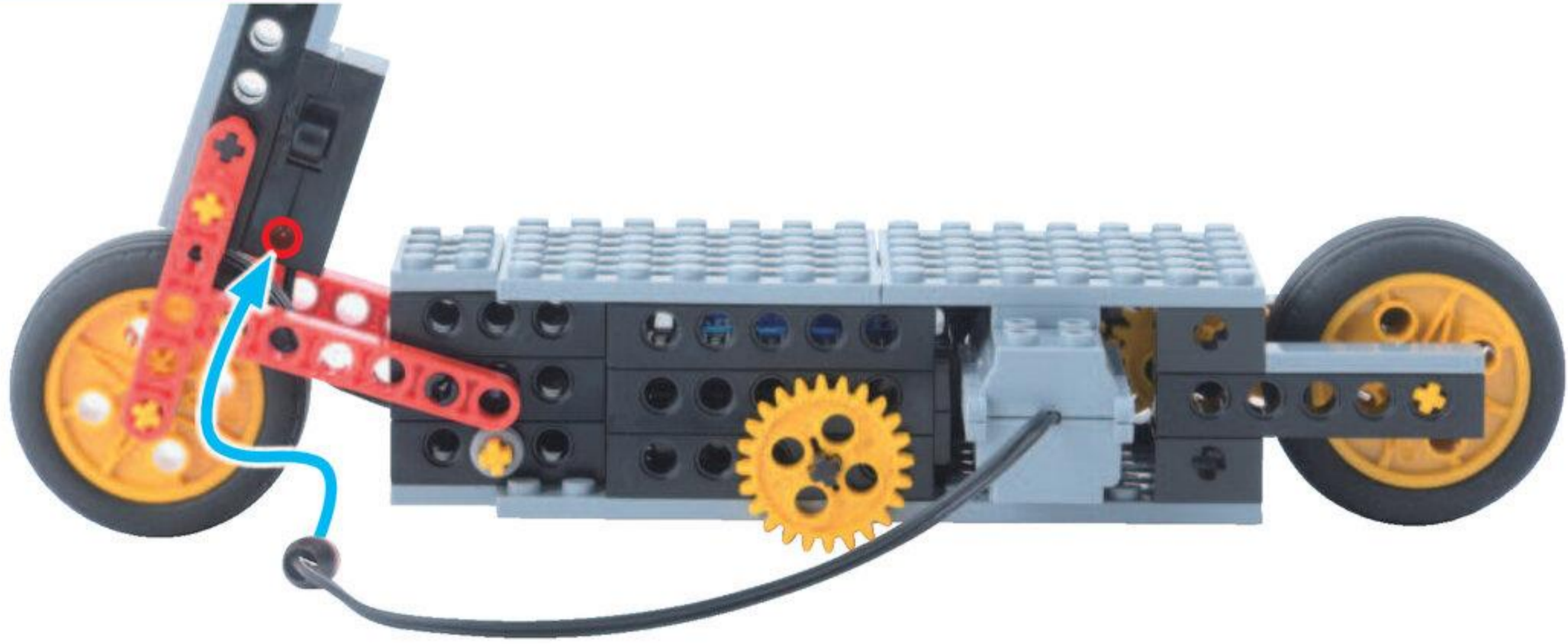

すいっち
スイッチをいれて うごかそう

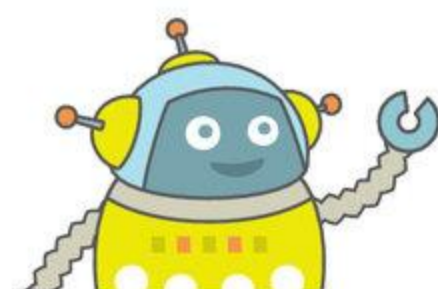
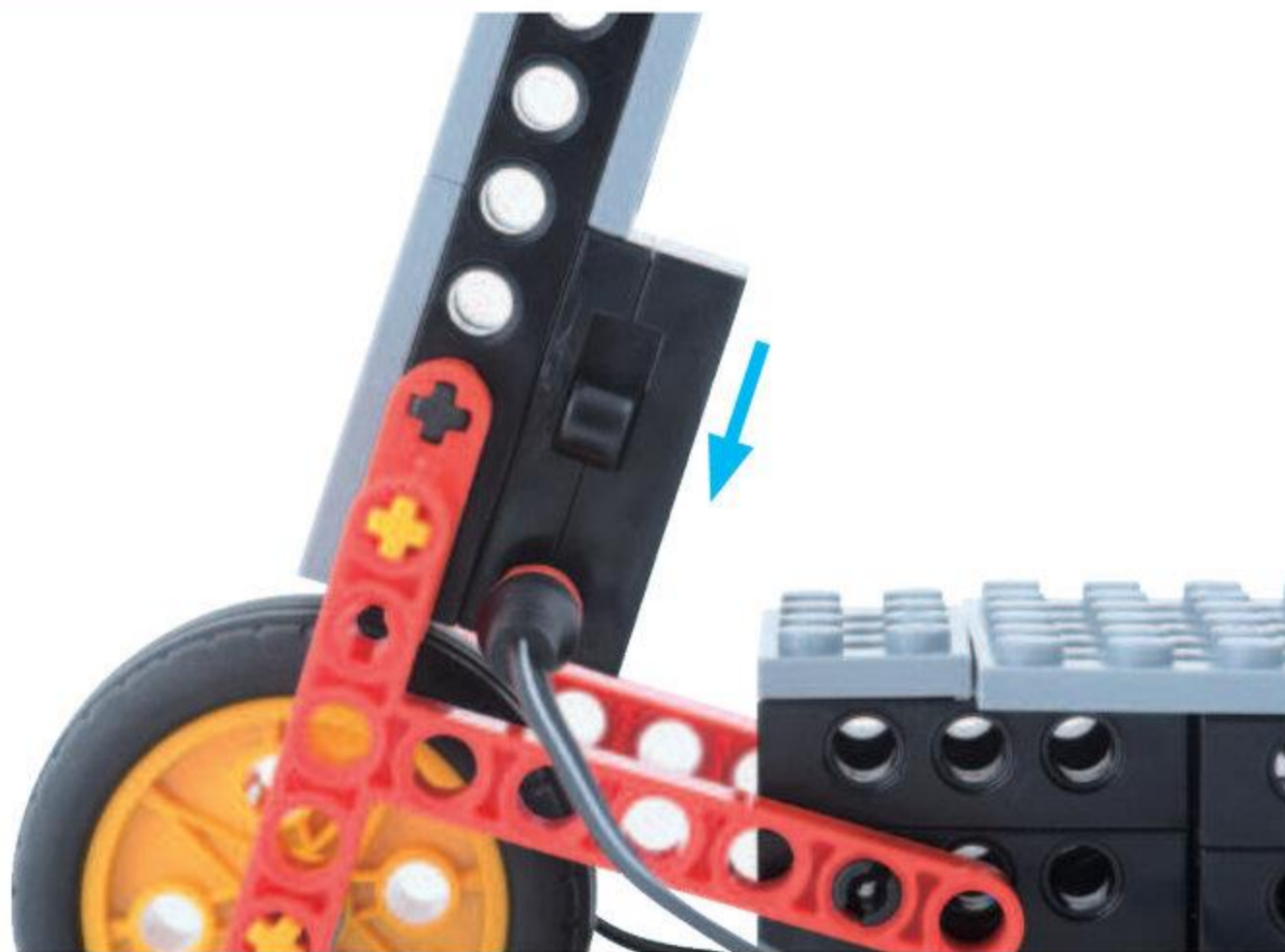

ろぼっと
ロボットは
まえにすすんだかな？

はんどる
ハンドルの おりたたみかた

す と っ ぱ あ
ストッパーを
はずして
おりたたもう

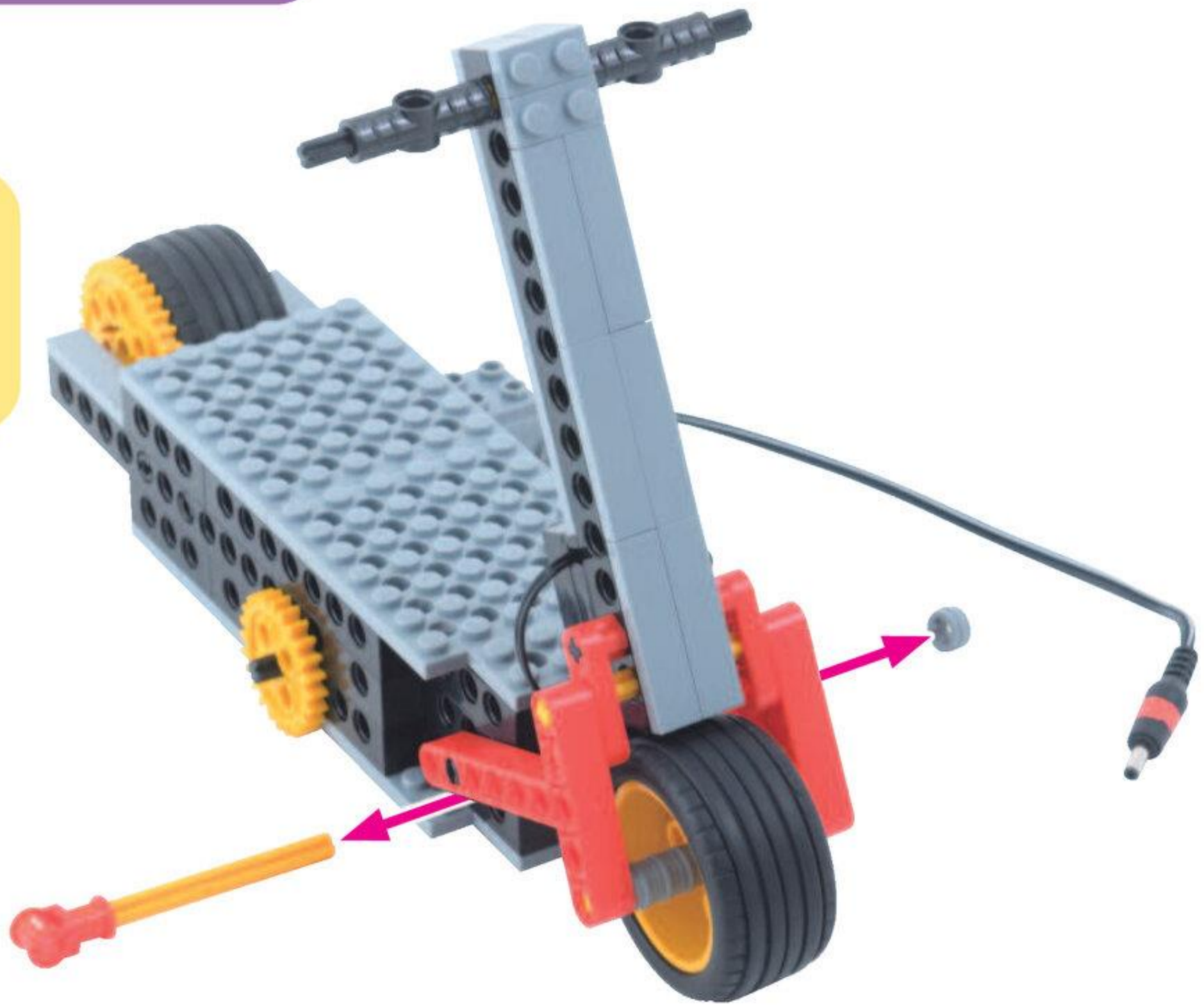
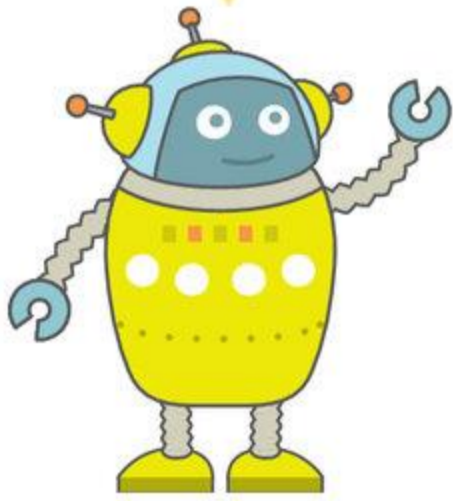

す と っ ぱ あ
はずしたストッパーは
はんどる
ハンドルにつけておこう

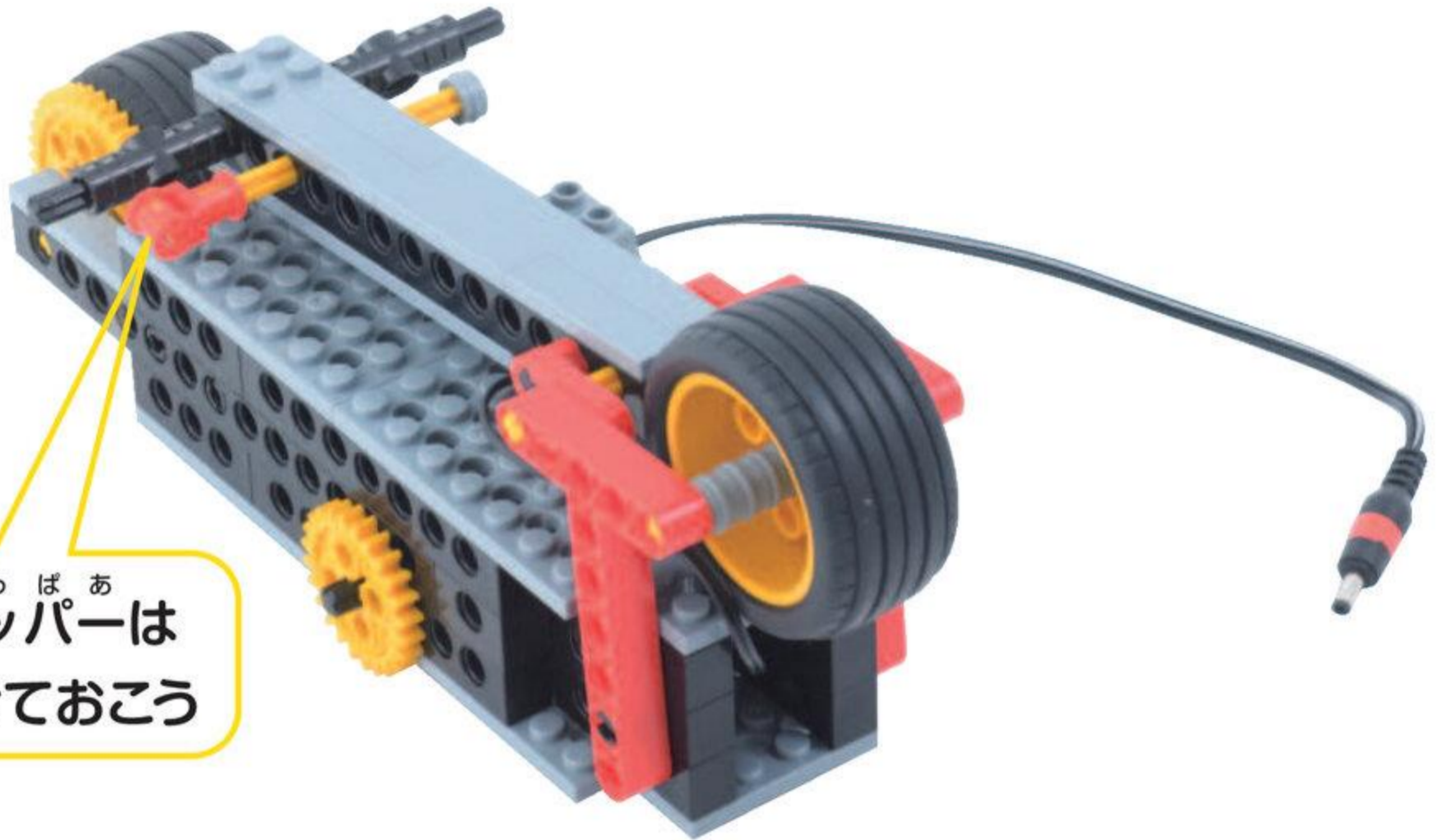

Q1 ^{ぎあ}ギア^えをさがそう! どれかな? どれかに○

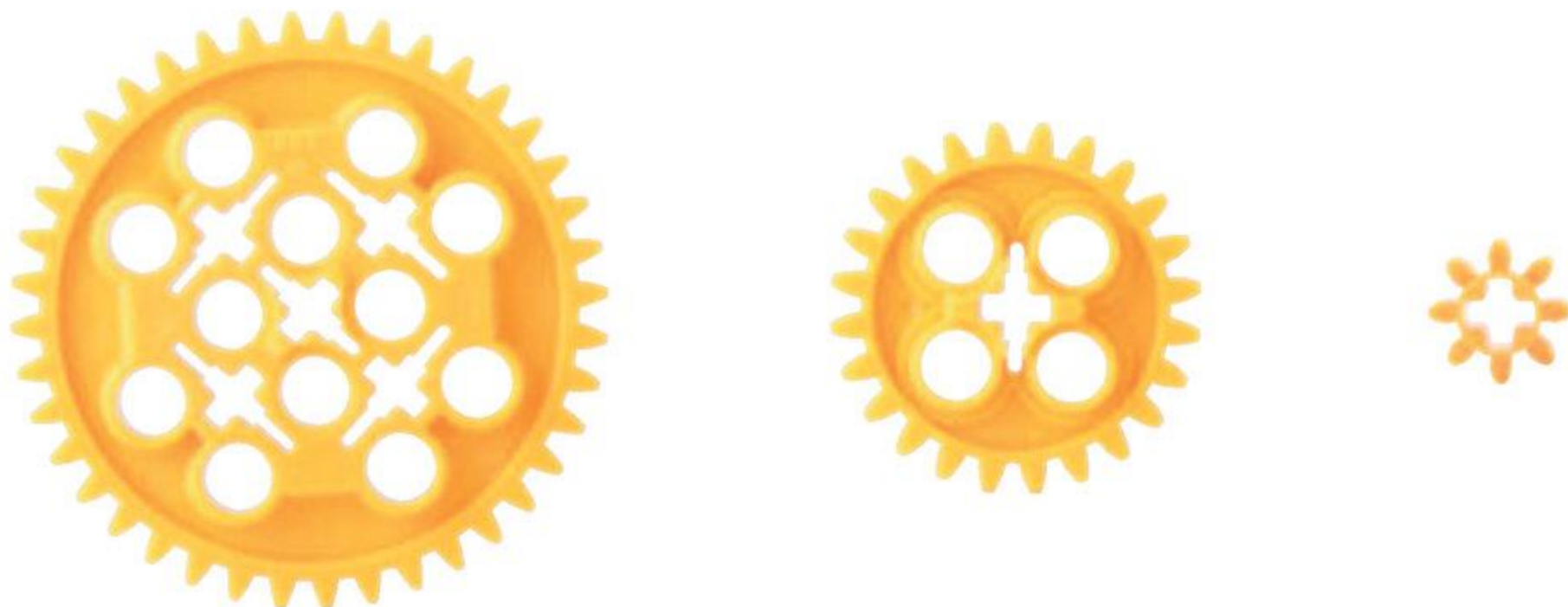

Q2 このギアには ^{ペグ}ペグ^{えす}S をなんことりつけられるかな?

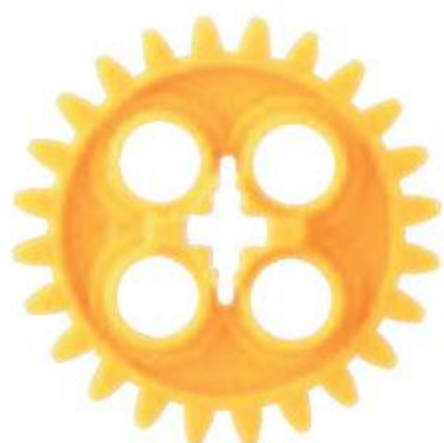

ペグ^{えす}S

(1こ・4こ・5こ) どれかに○

Q3 このギアには ^{シャフト}シャフト をなんぼんとりつけられるかな?

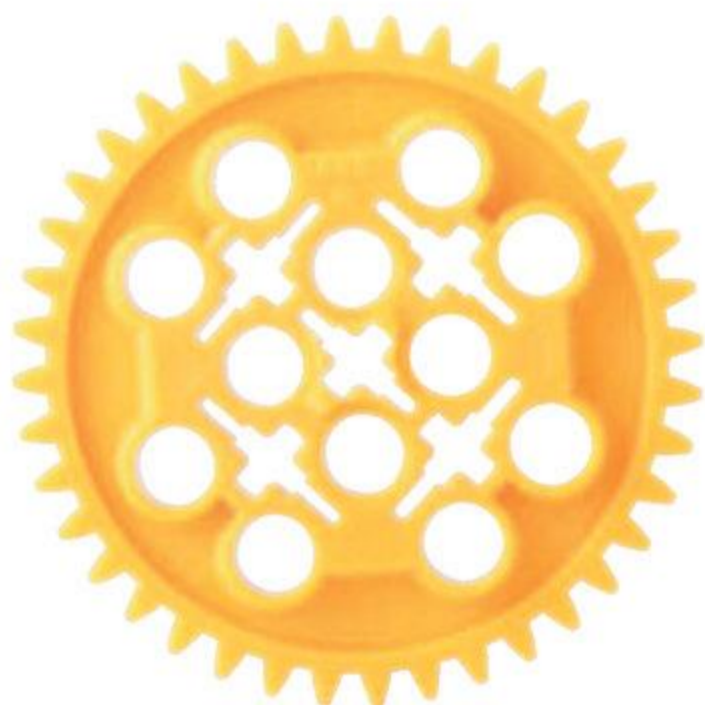

シャフト^{よん}4ポチ

(1ぽん・5ほん・12ほん) どれかに○



Human

ヒューマンアカデミー ジュニア
STEAMスクール



ロボット教室

ロボットのきょうかしよ

プレプライマリーコースⅡ

2

のってはしって「キックボーダー」
き っ く ほ お だ あ



★だい2かい

2023 ねん

4 がつ

にち

なまえ

もくじ

だい 2 かい

きょうの よてい	47	2ふん
くみたて		80ふん
1. あたま	48~51	
2. ひだりあし	52~57	
3. みぎあし	58~64	
4. みぎうで	65~67	
5. ひだりうで	68~73	
ロボットを うごかそう	74	
ゴールをつくってはしらせよう	75	
じゆうに かいぞうしてみよう	76	
まちがい さがし	77	3ふん
かたづけ		5ふん

はんだる
ハンドルを たてて
す とっ ばあ
ストッパーを もどしておこう

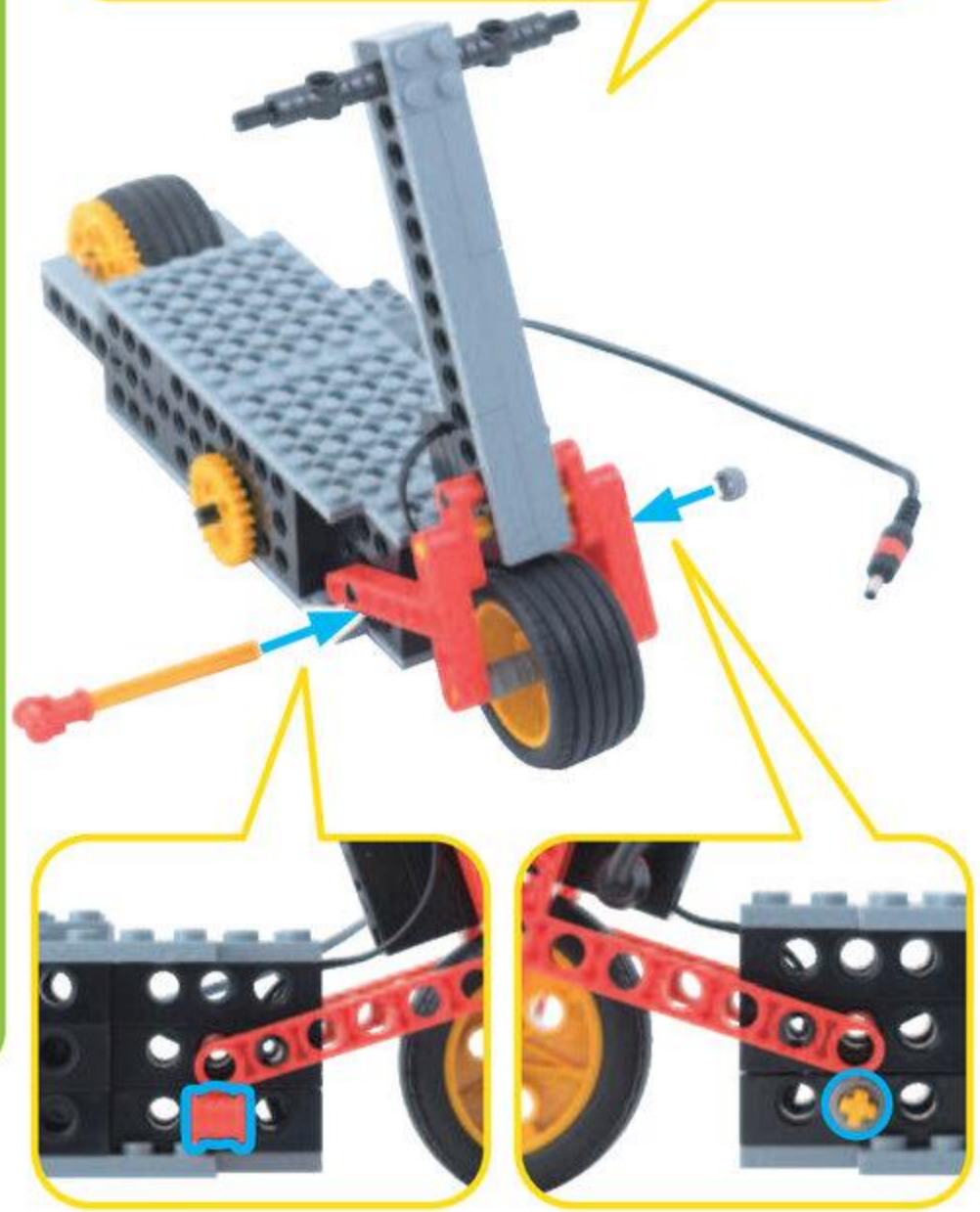

こんかいは ひとを
つくって のせるよ

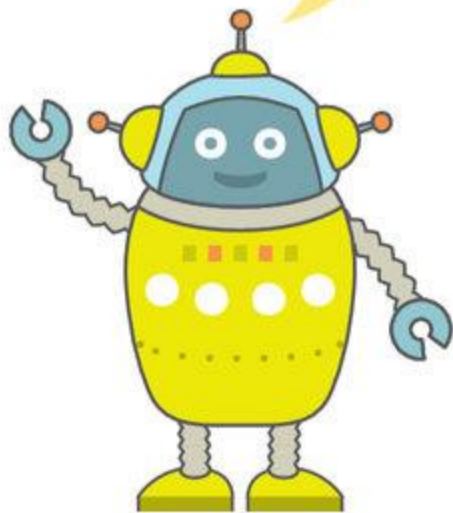

きょうの よてい

めやす 2 ふん

このじゅんばんでつくるよ!



①あたま



②ひだりあし



③みぎあし



④みぎうで



⑤ひだりうで



1 あたま

めやす 5 ぶん



タイヤ^す S 1こ



タイヤ^る L 1こ



シャフト^{とろく} 6ポチ 1こ



ながさに
ちゅうい

1



こむ
ゴムをはずすのは
せんせいに
やってもらおう

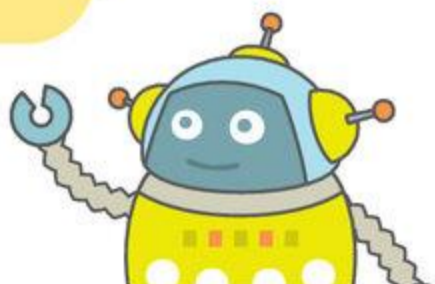

びいむろくほち
ビーム 6 ポチ 2こ



びいむにほち
ビーム 2 ポチ 1こ



びいむよんほち
ビーム 4 ポチ 1こ

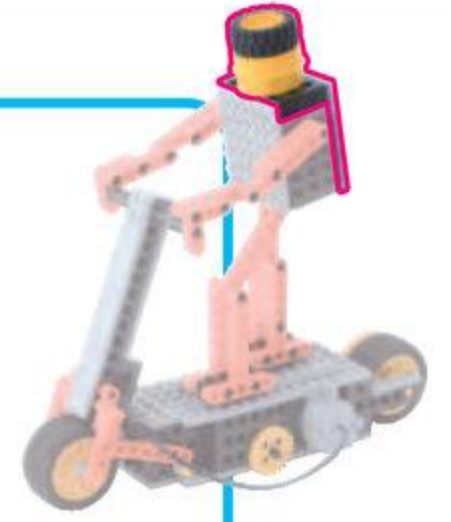

2

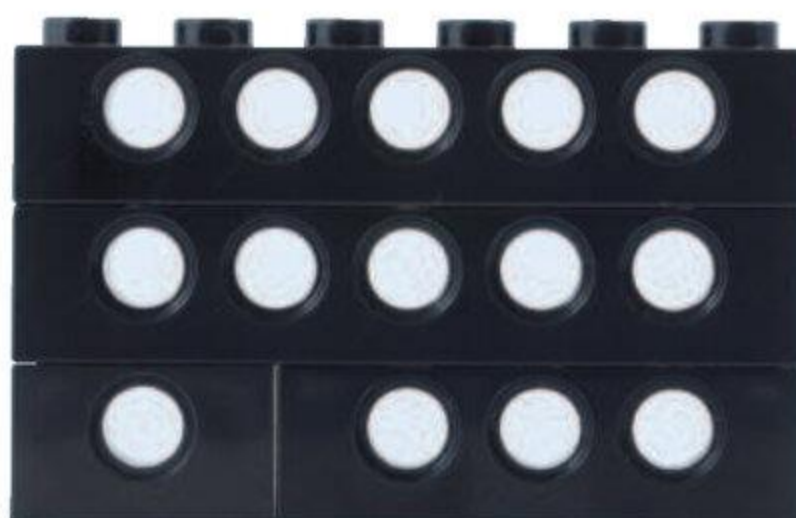

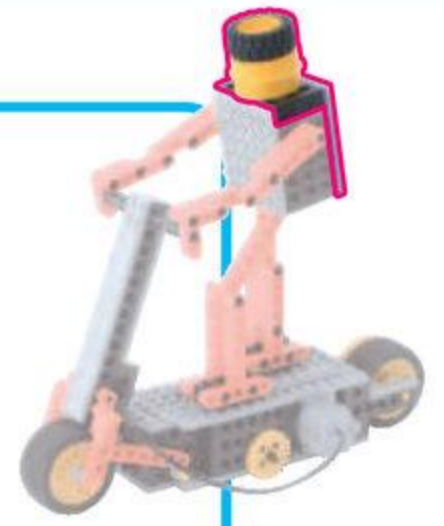

ぶれえとる
プレート 1こ

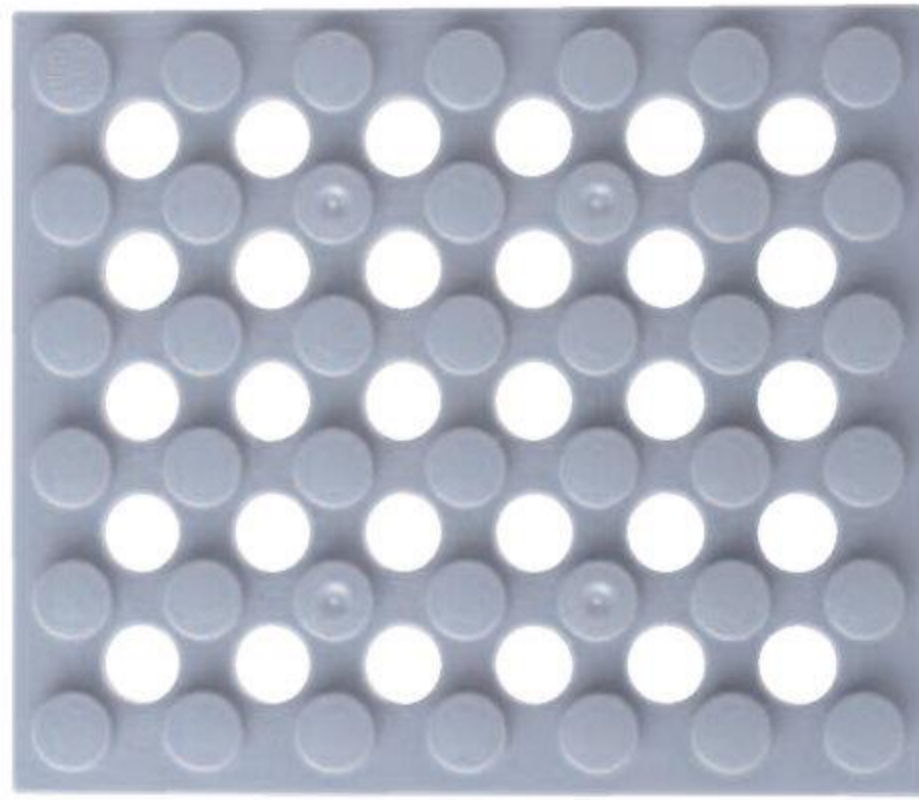

3

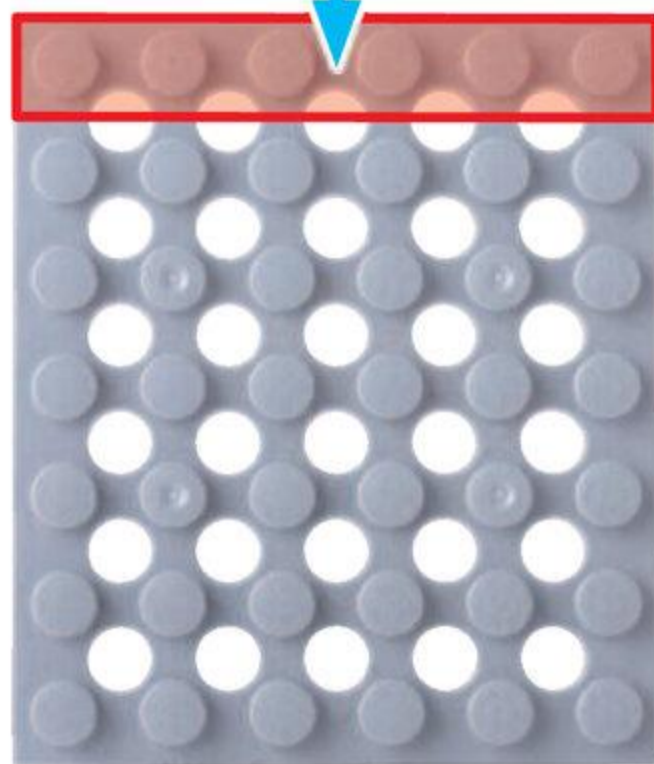
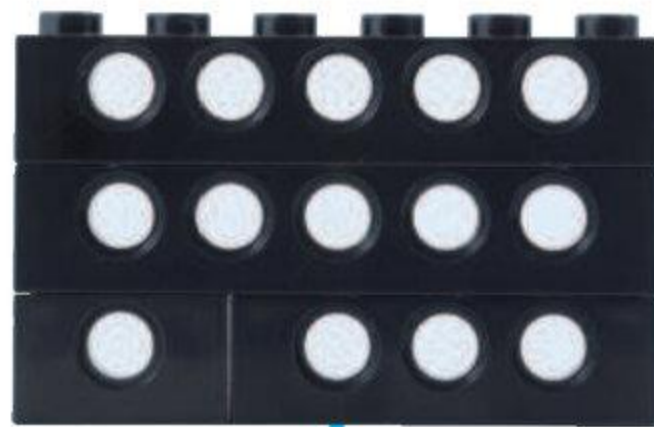

ながさに ちゅうい
みじかい

← 6 5 4 3 2 1 →

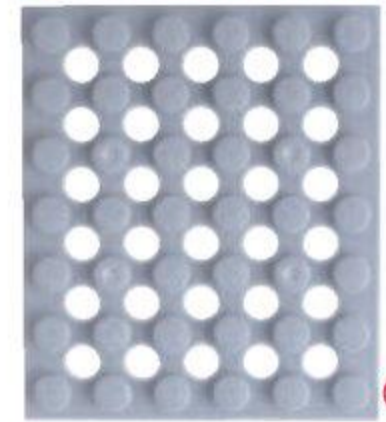

ながい

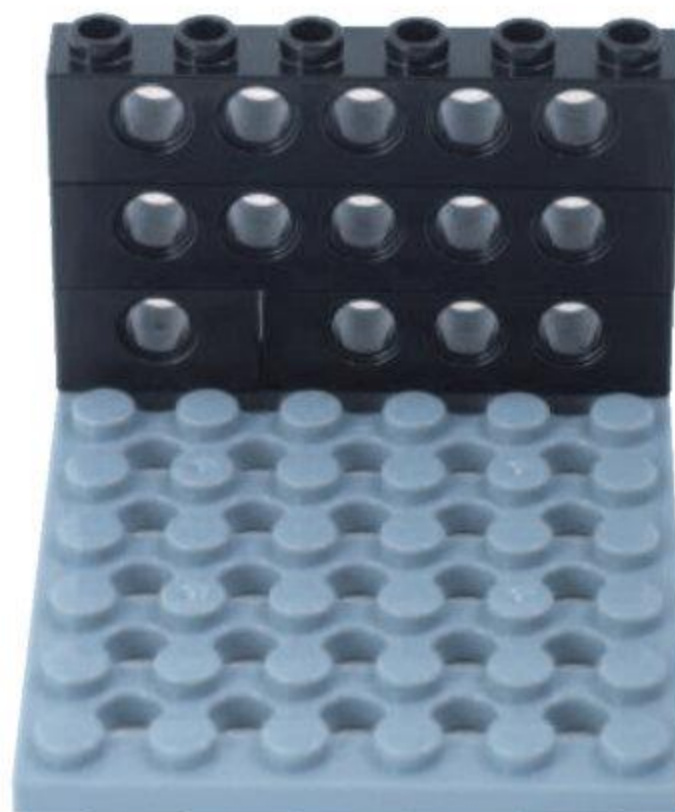

ぶっしゅ
ブッシュ 1こ

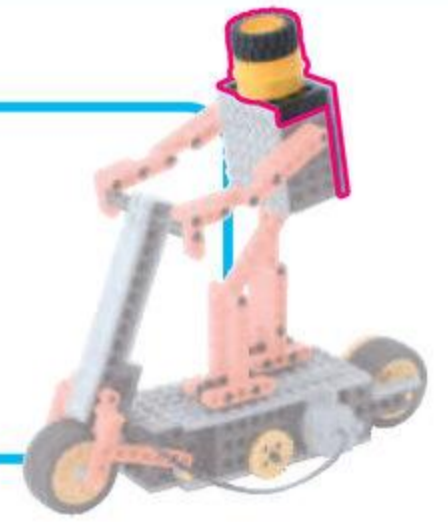

4

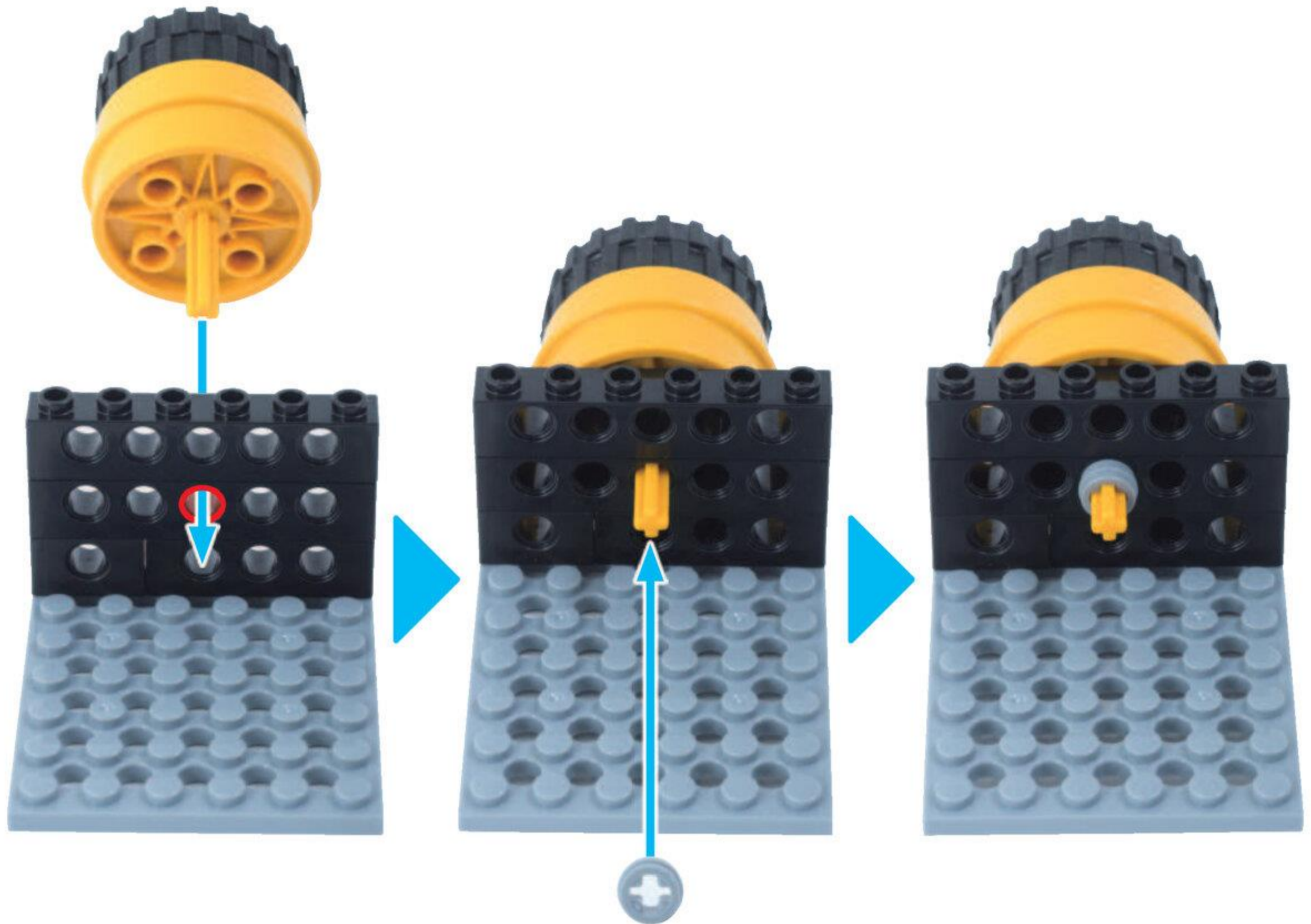

あたまが
かんせい!

やったね!



2 ひだりあし

めやす 10 ぶん

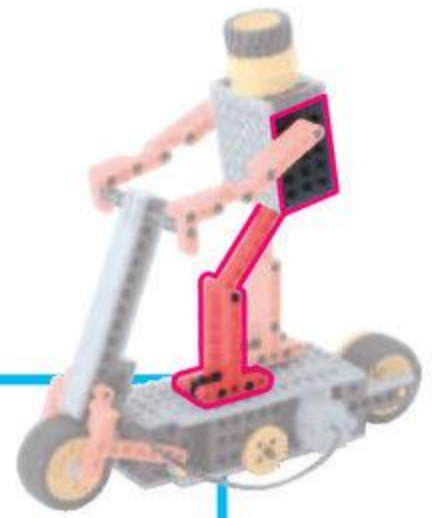

ろっど きゅう あな
ロッド 9 アナ 1こ



てい ろっど
T ロッド 1こ

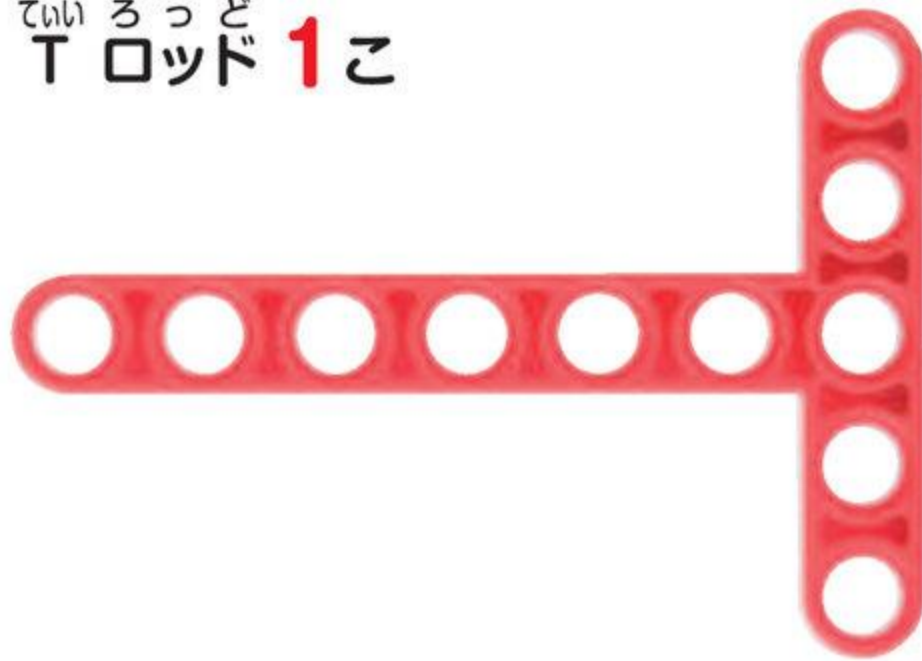

ペグ^え L 3こ



ペグ^え S 1こ



1

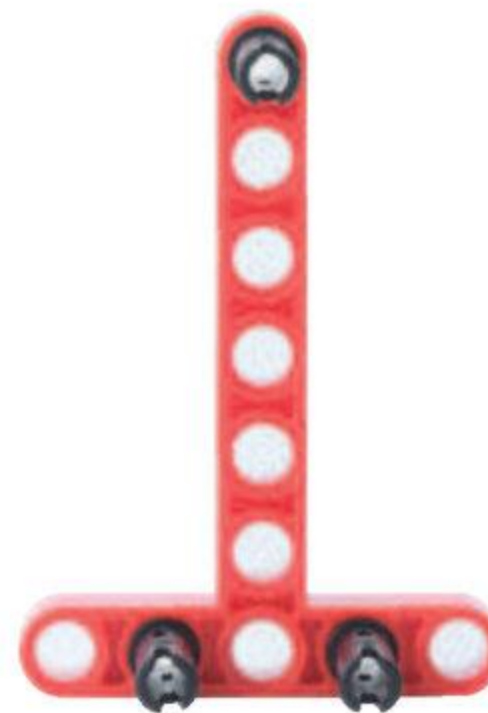
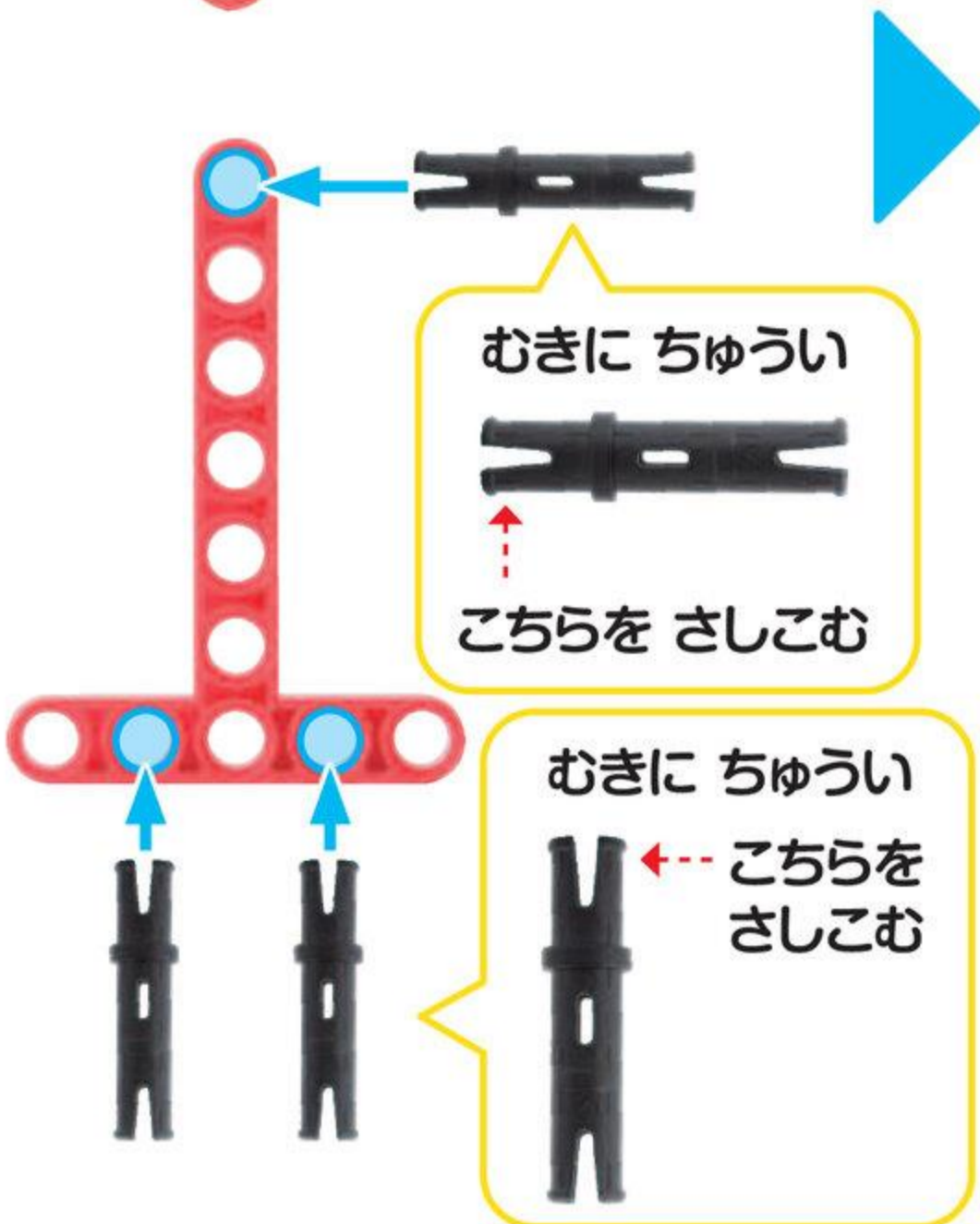
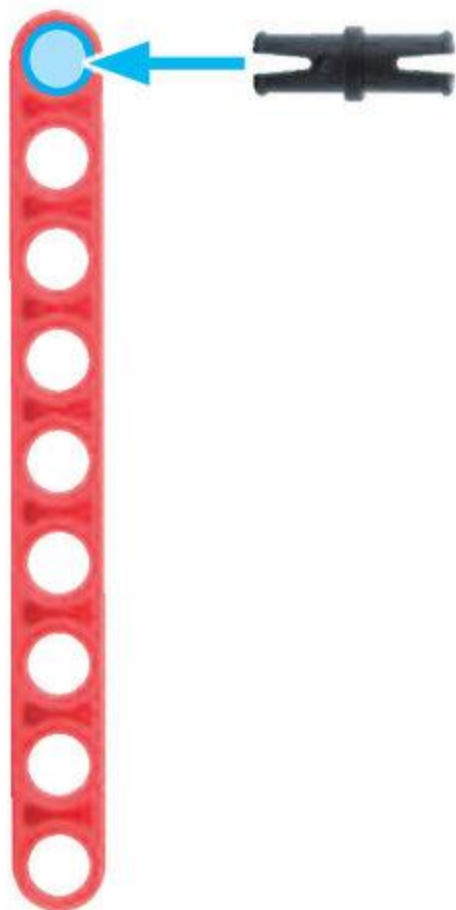

びいむ ぽち
ビーム4 ポチ 1こ

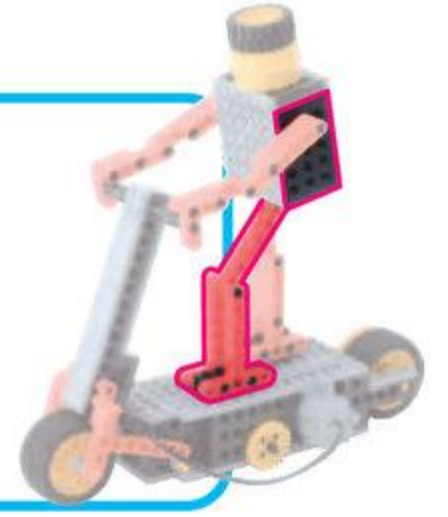

2

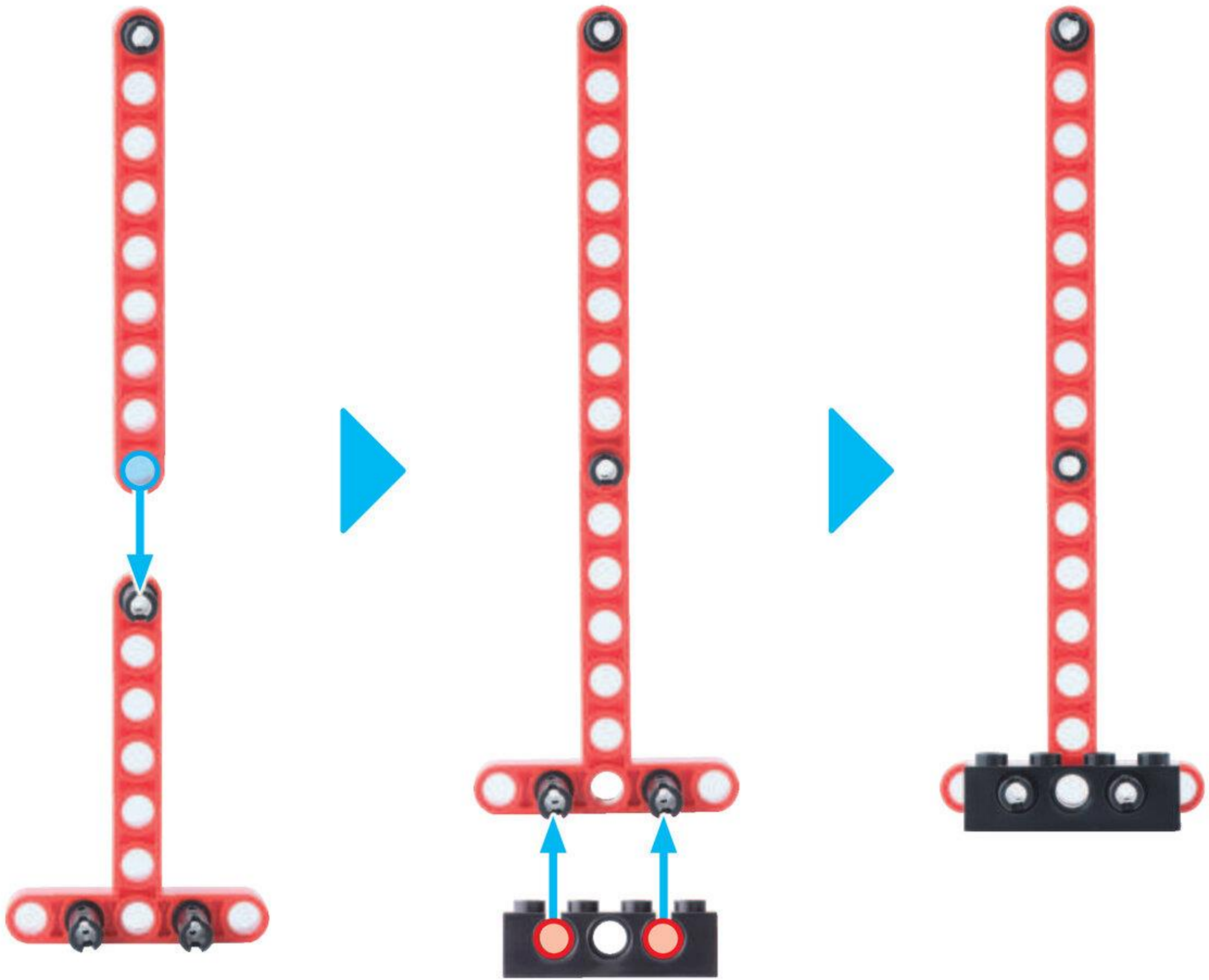

てい ろっど
T ロッド 1こ

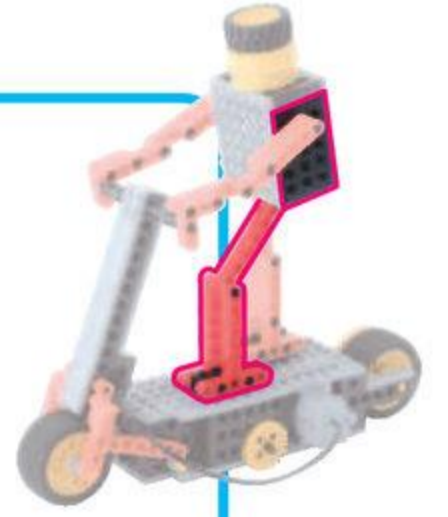
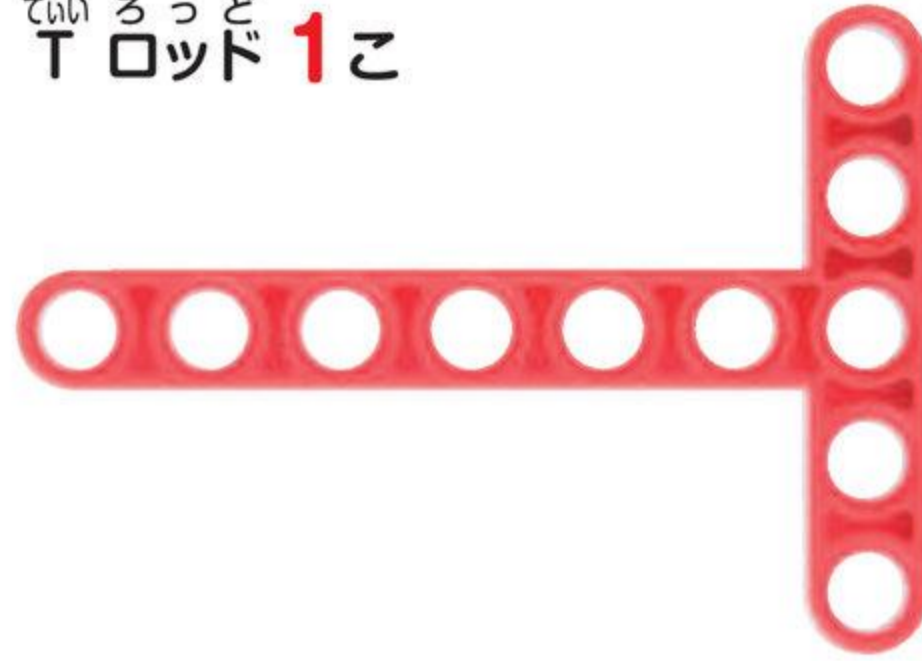

3

この ^{peg} ^S だけが
とびだしているよ

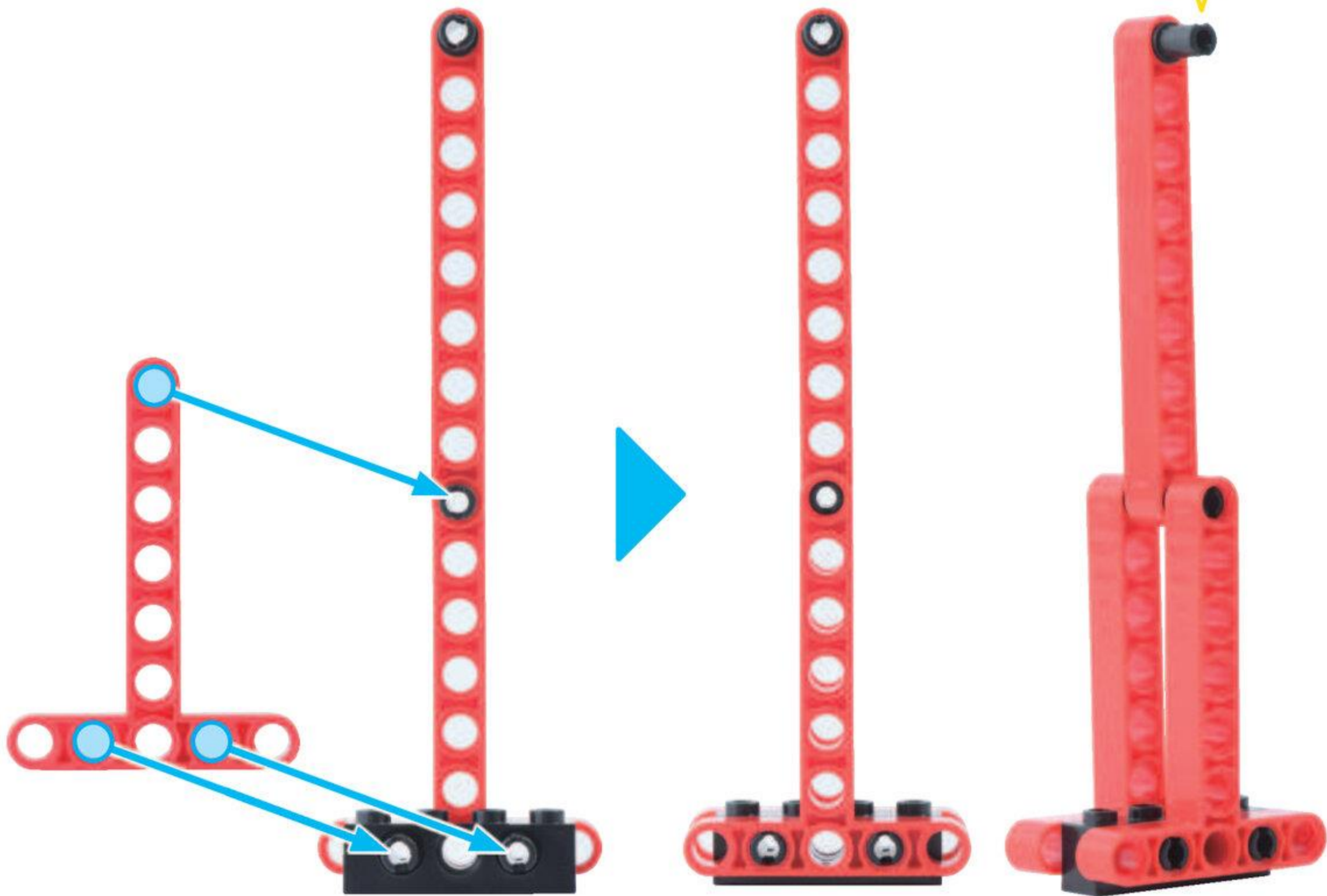

ひだりあしが
かんせい!

やったね!

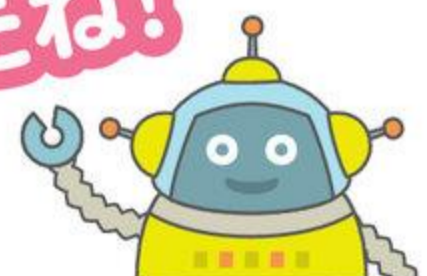

びいむろくほち
ビーム6ポチ 3こ

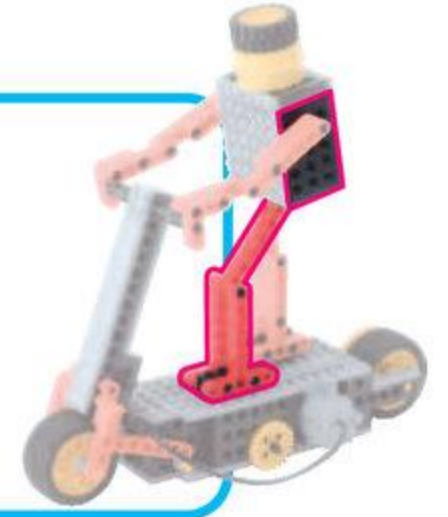

4

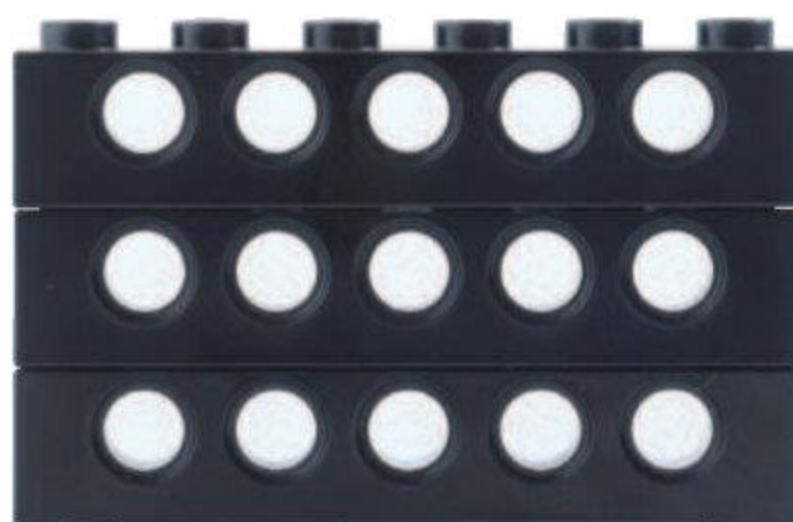

5

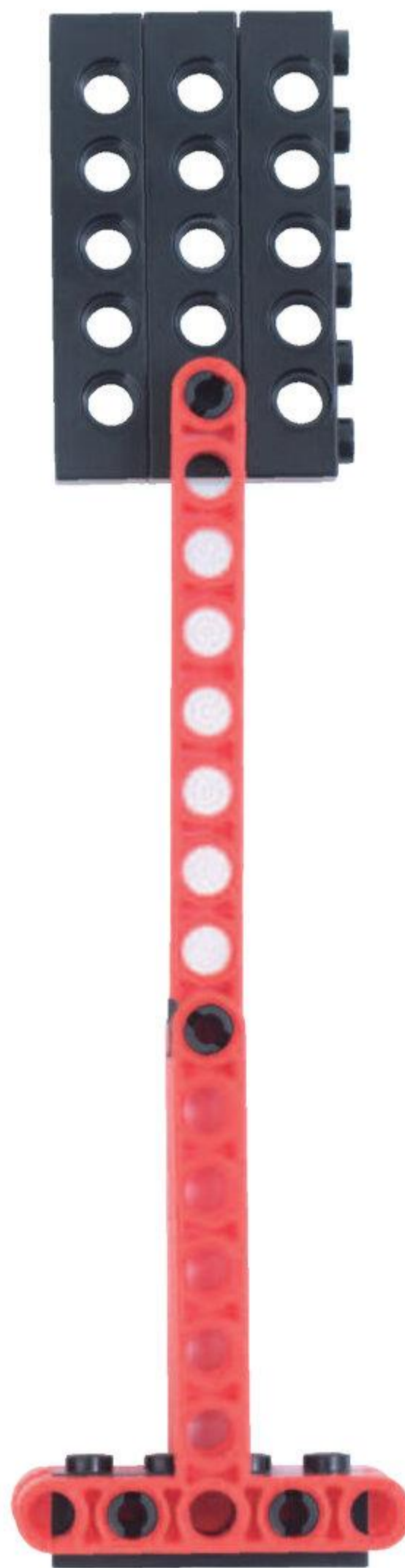

6

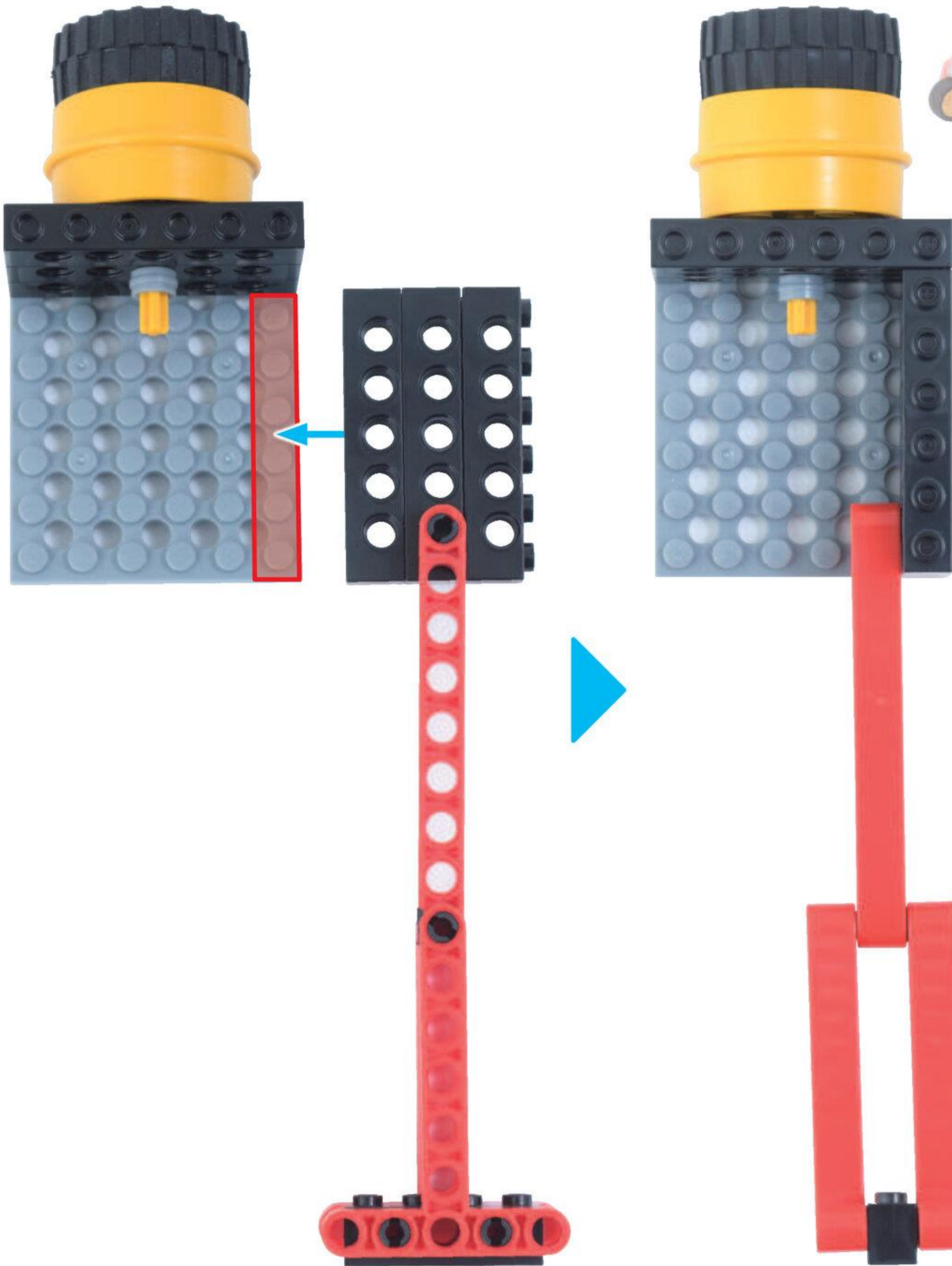

ひだりあしと
あたまが がつたい!

やったね!

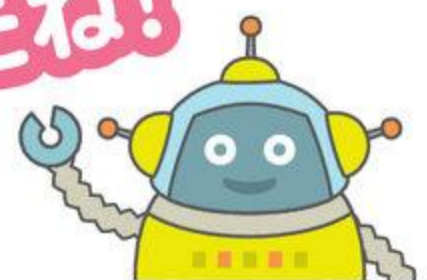

3 みぎあし

めやす 10 ぶん

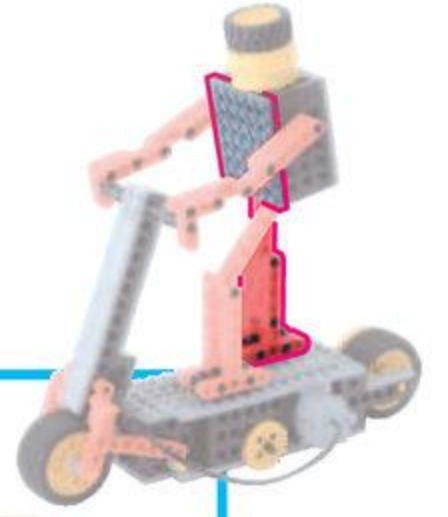

ろっど 15 アナ 1 こ



てい ろっど T ロッド 1 こ

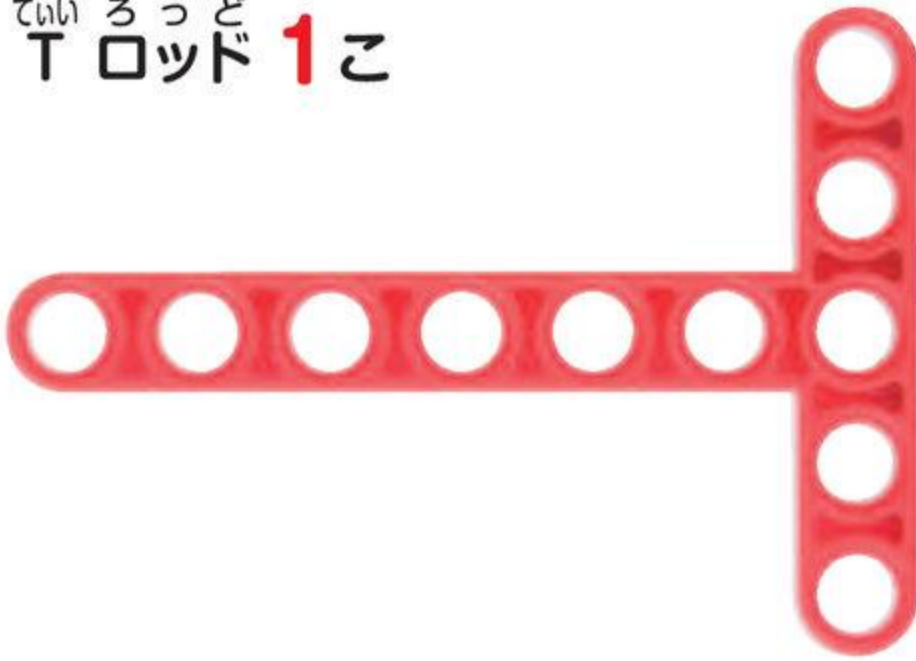

peg 4 こ



peg S 1 こ



1

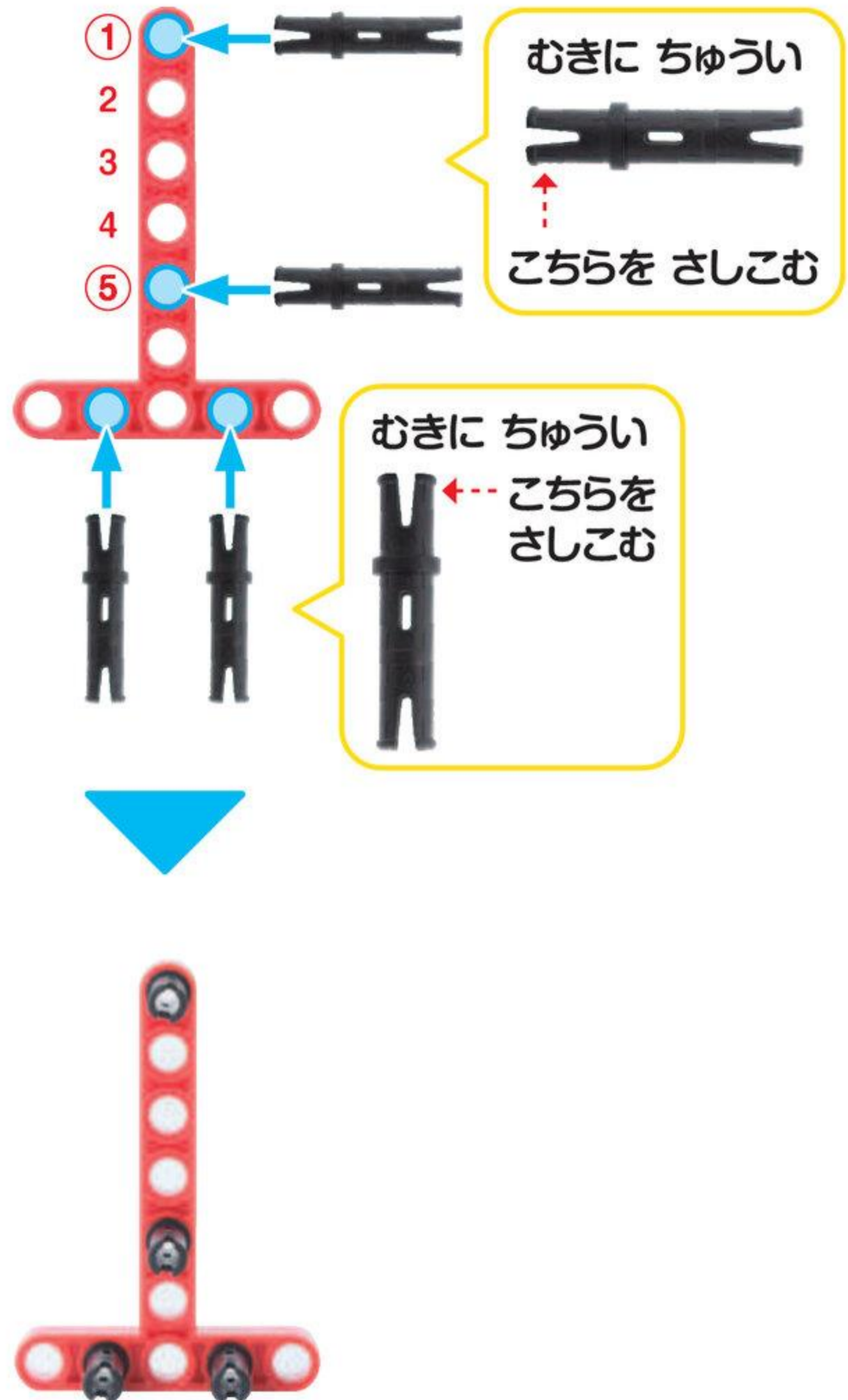
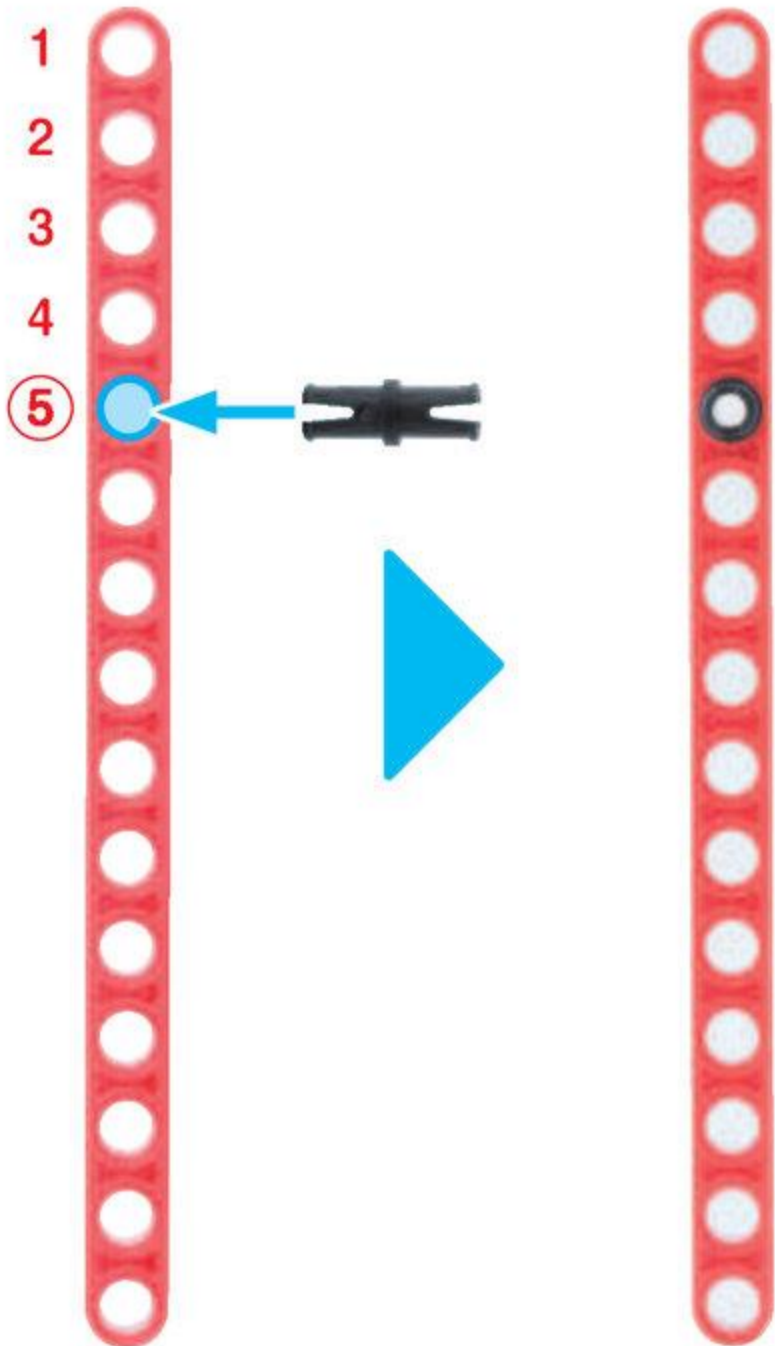

びいむ ぽち
ビーム4 ポチ 1こ

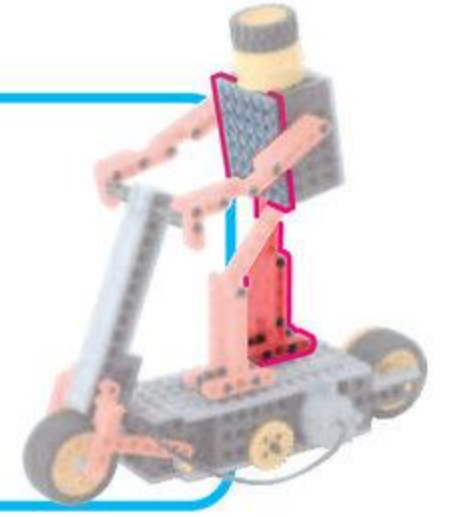

2

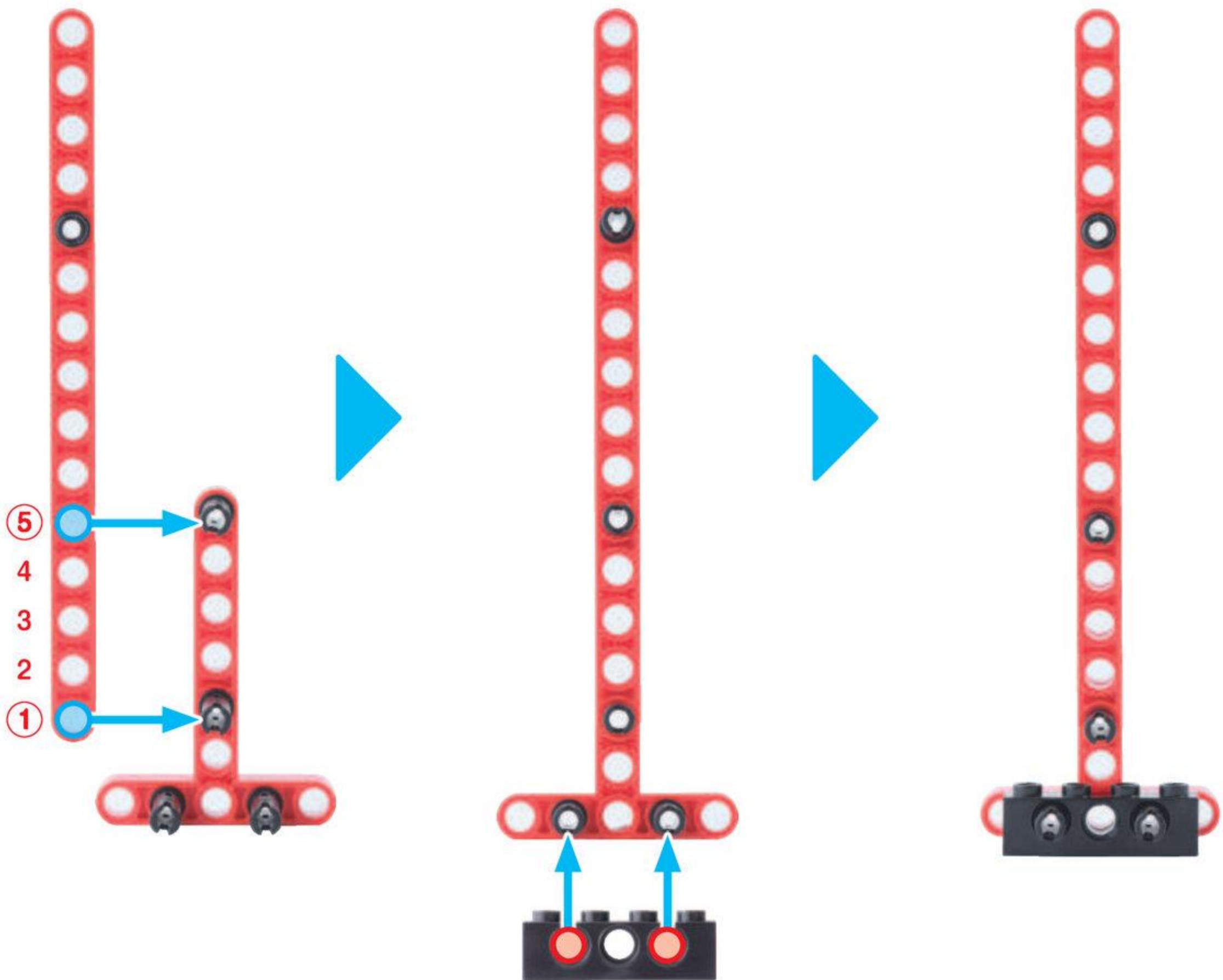

びいむろくほち
ビーム6ポチ 3こ

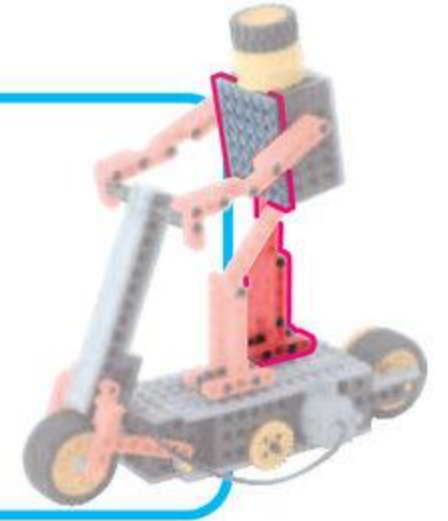

4

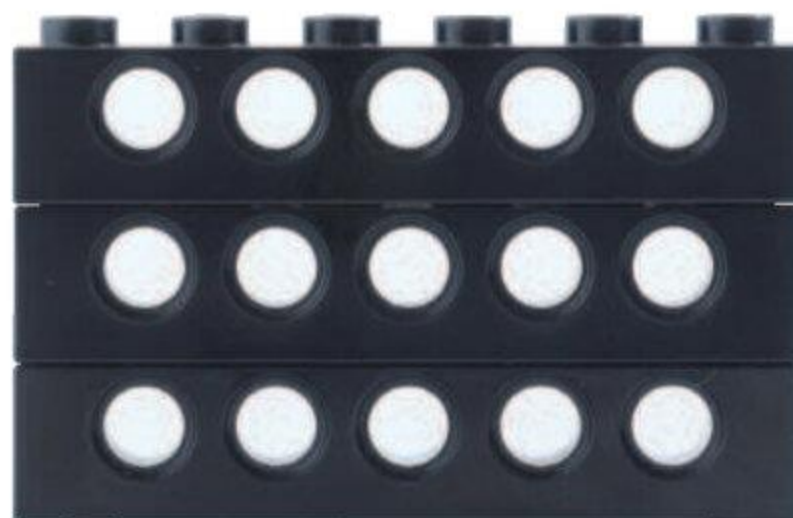

5

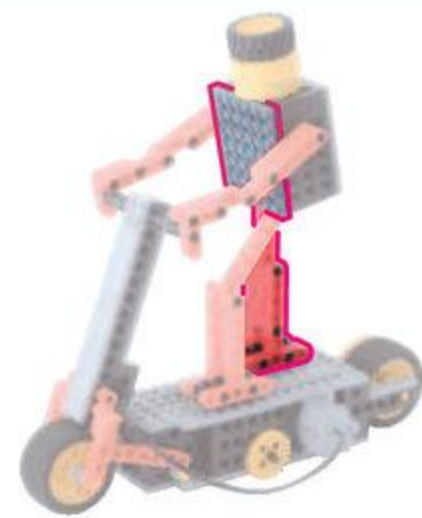

6

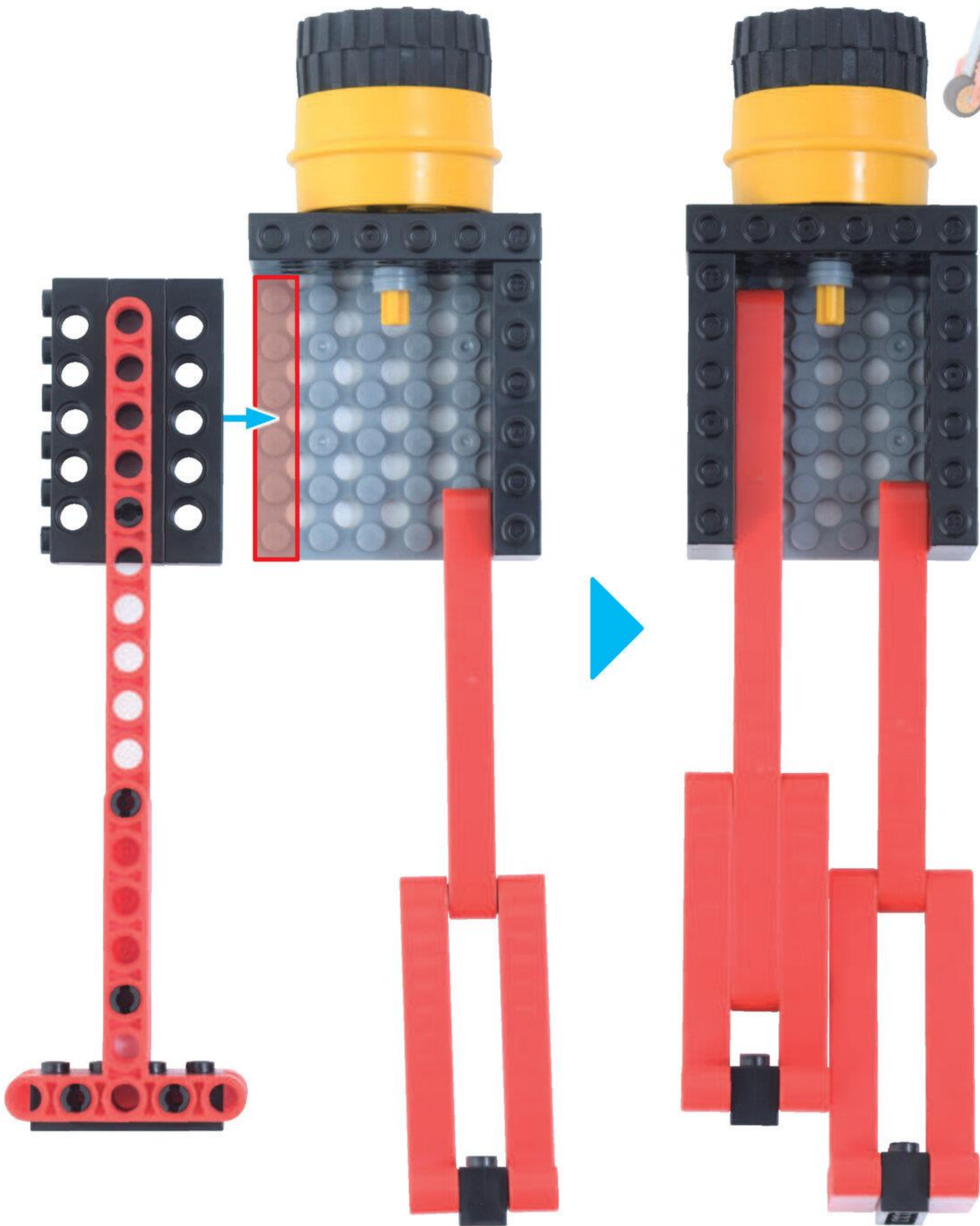



ぶれえとろ
プレート 1こ

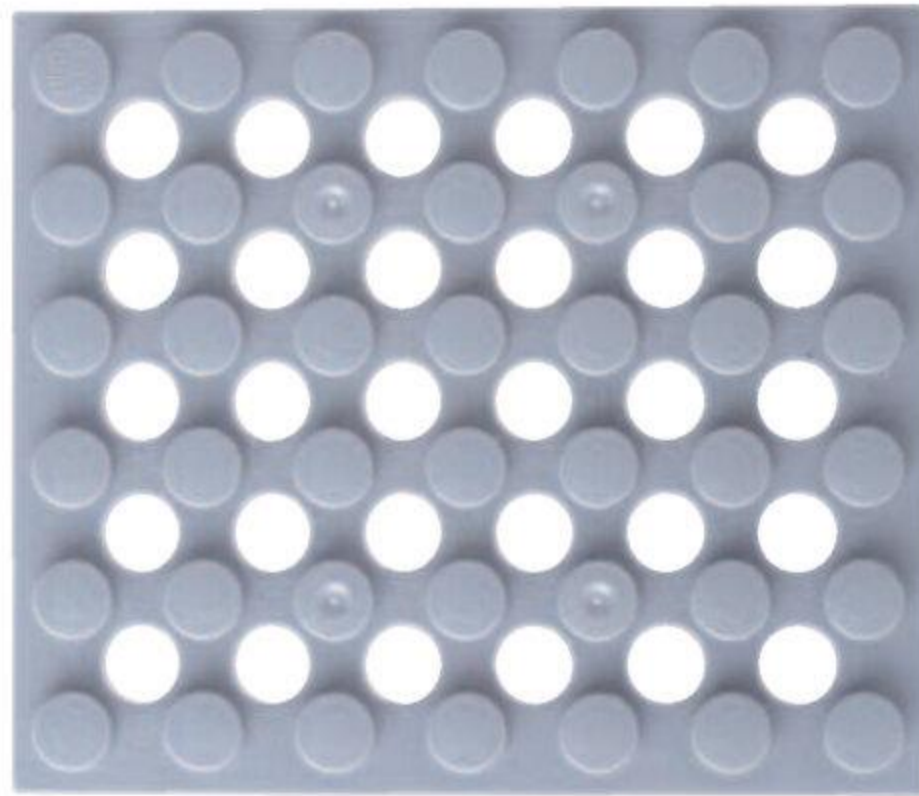

7

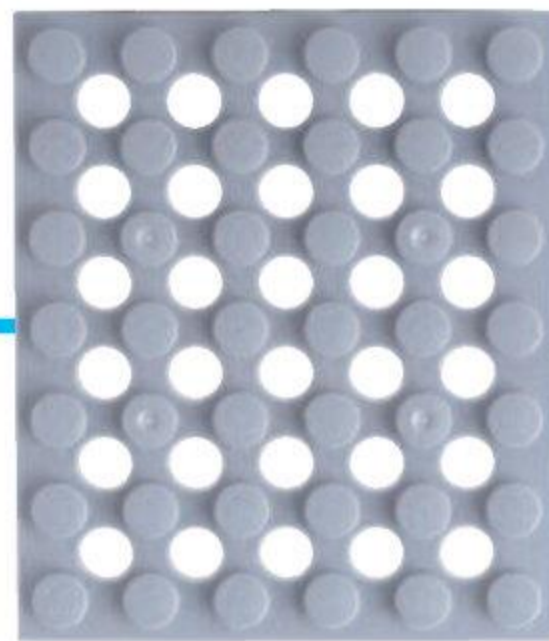

ながさに ちゅうい
みじかい

⑥ 5 4 3 2 1

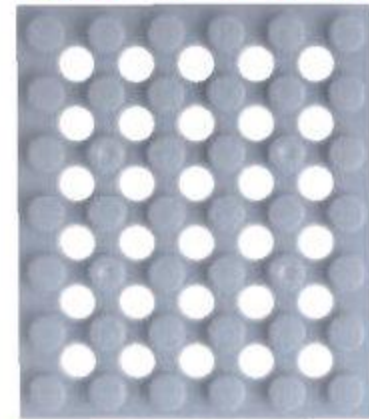

ながい

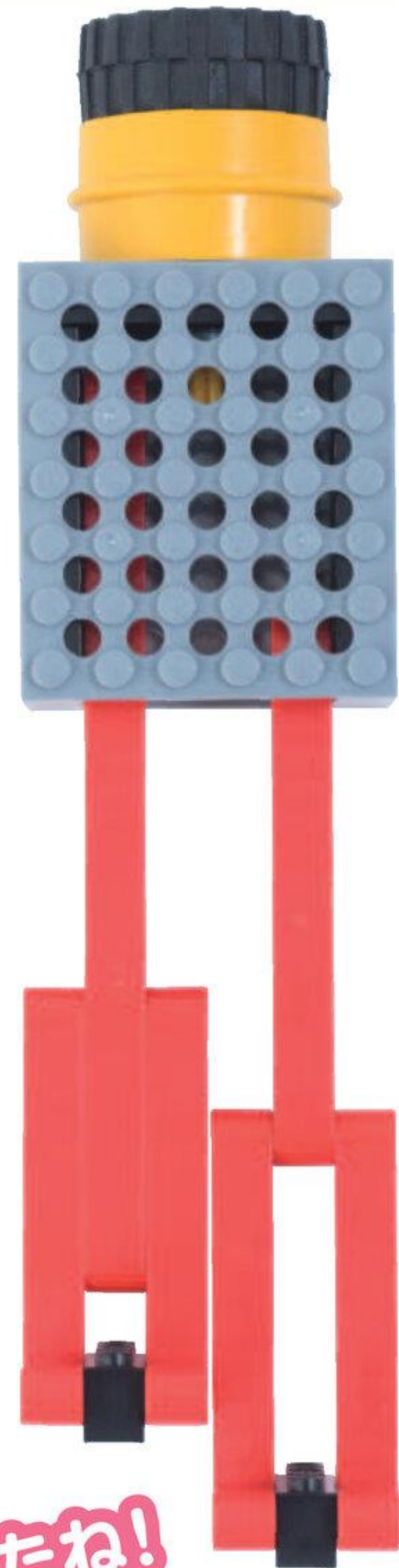

やったね!

みぎあしと あたまが
がつたい!

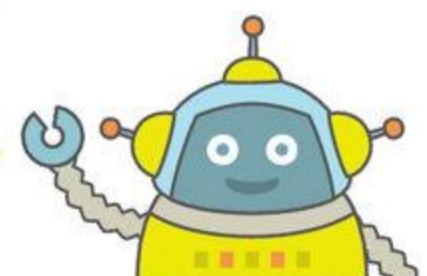

4 みぎうで

めやす 10 ぶん

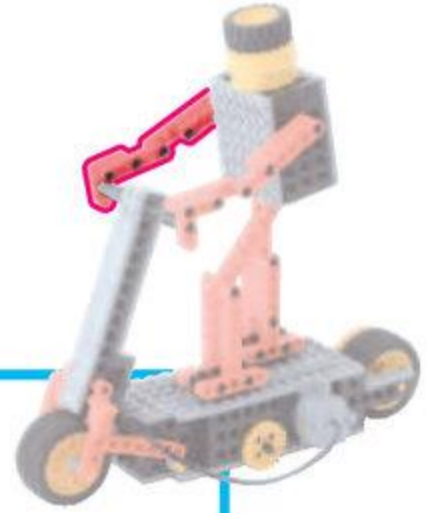

ろつど^なア^な 1こ



peg^る 1こ



peg^す 4こ



ろつど^る 1こ



1

むきにちゅうい
こちらをさしこむ

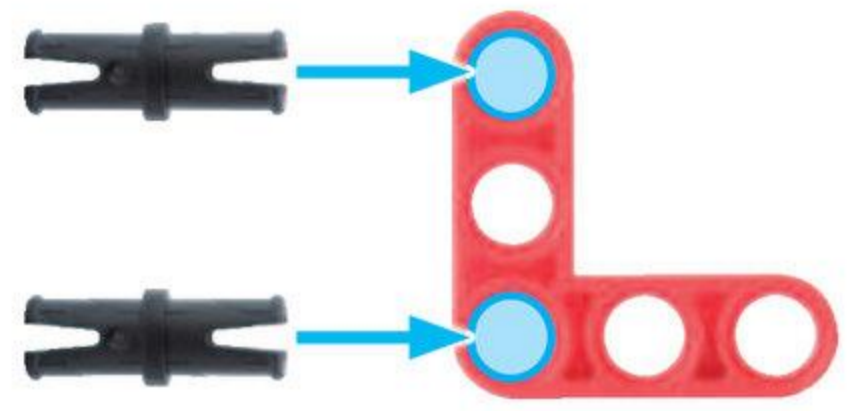
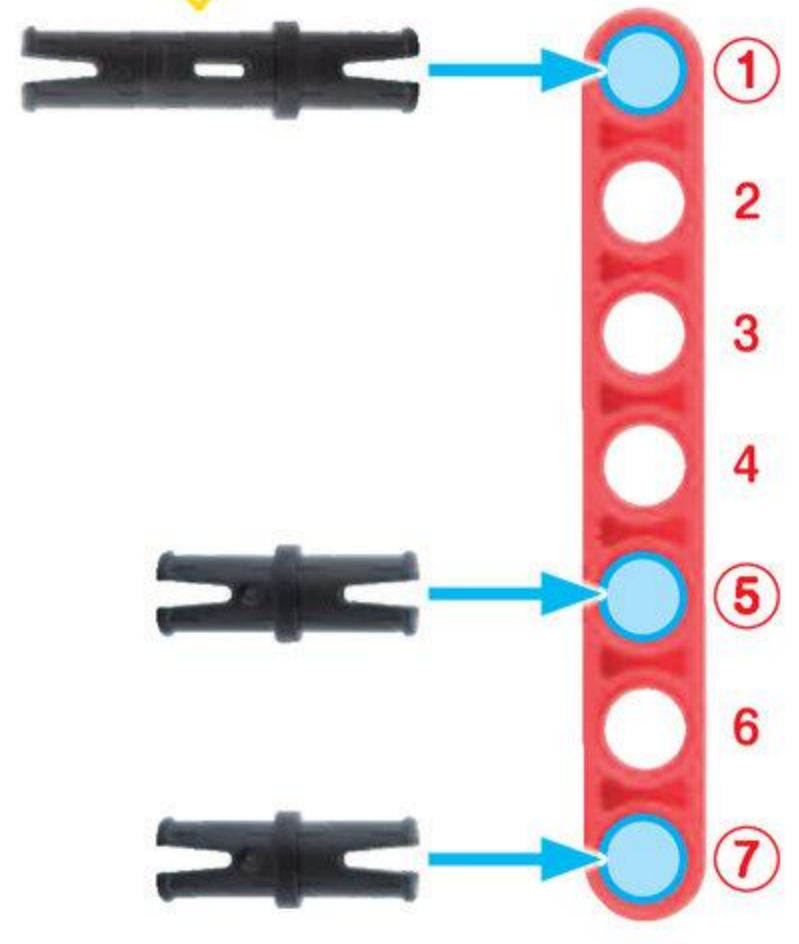

3

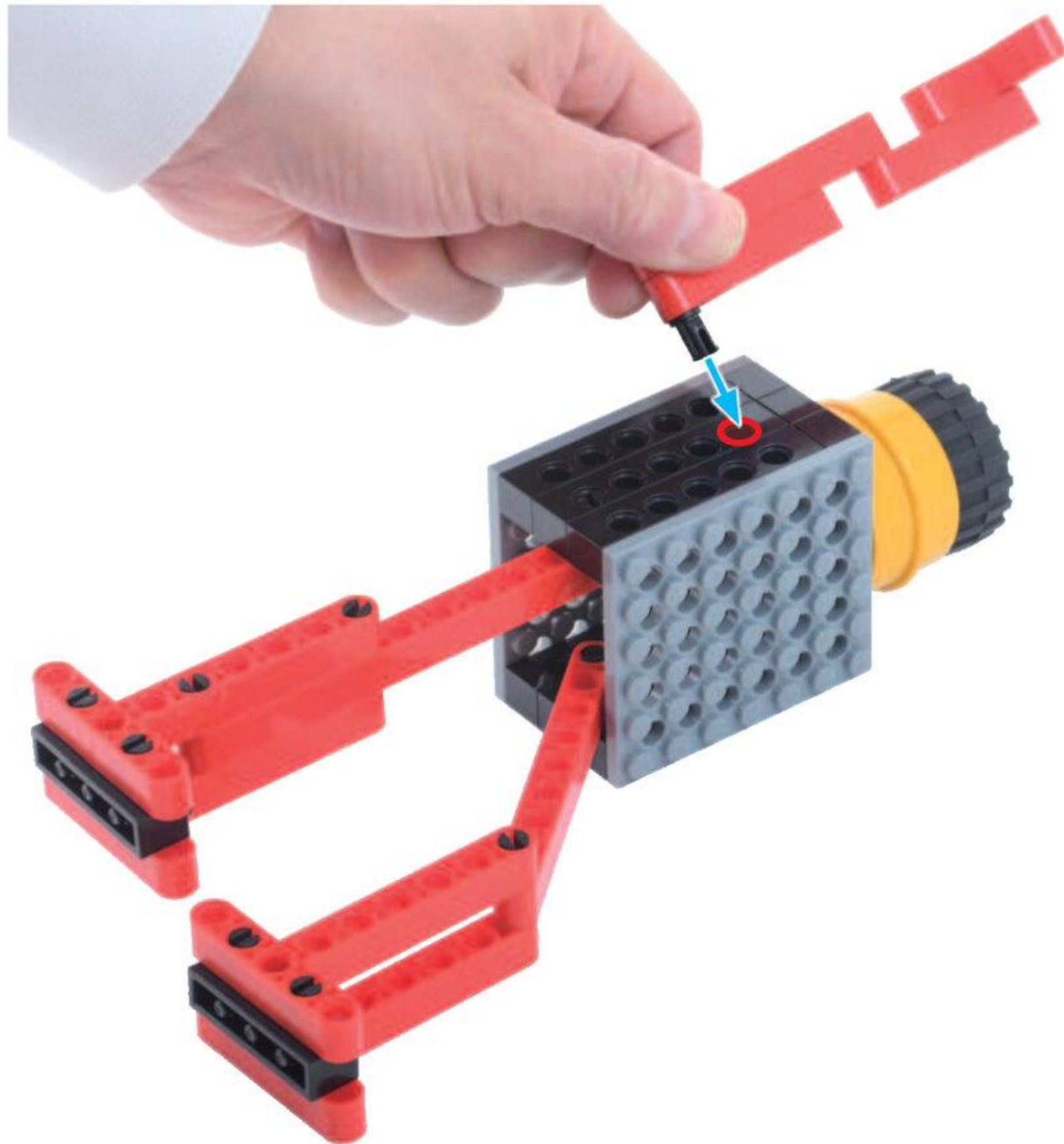

みぎうでが
かんせい!

やったね!

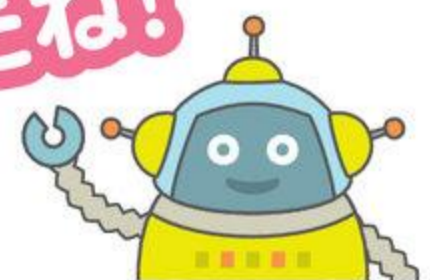

5 ひだりうで

めやす 15 ぶん



ろっど^なアナ^な 1こ
 ロッド7

ろっど^ろシ^ろ 1こ

peg^えシ 1こ

peg^えS 4こ

1

むきに ちゅうい
 こちらを さしこむ

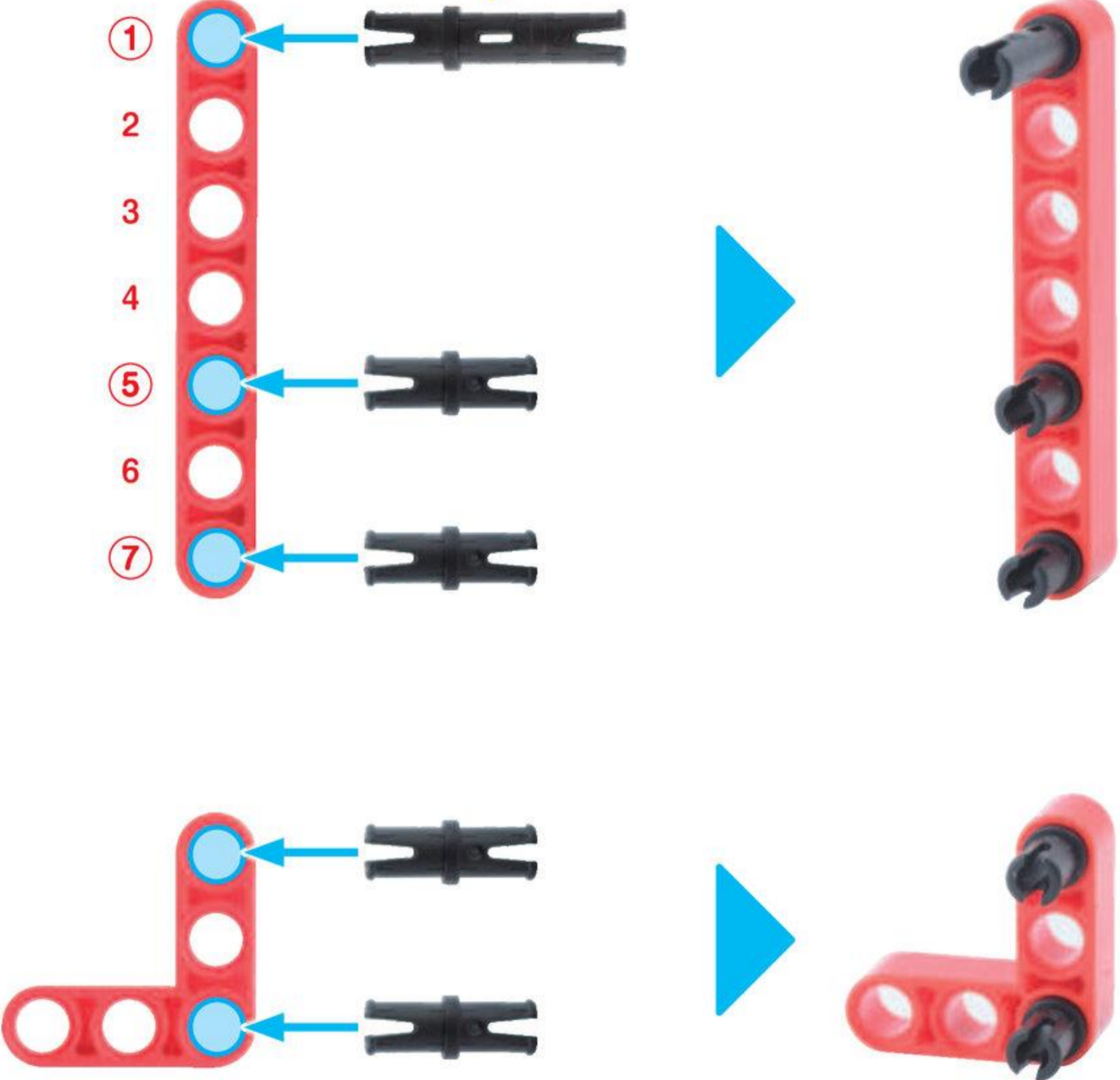

ろっどごあな 2こ
ロッド5アナ

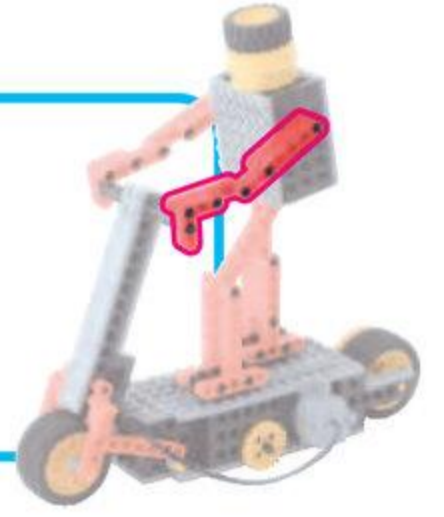

2

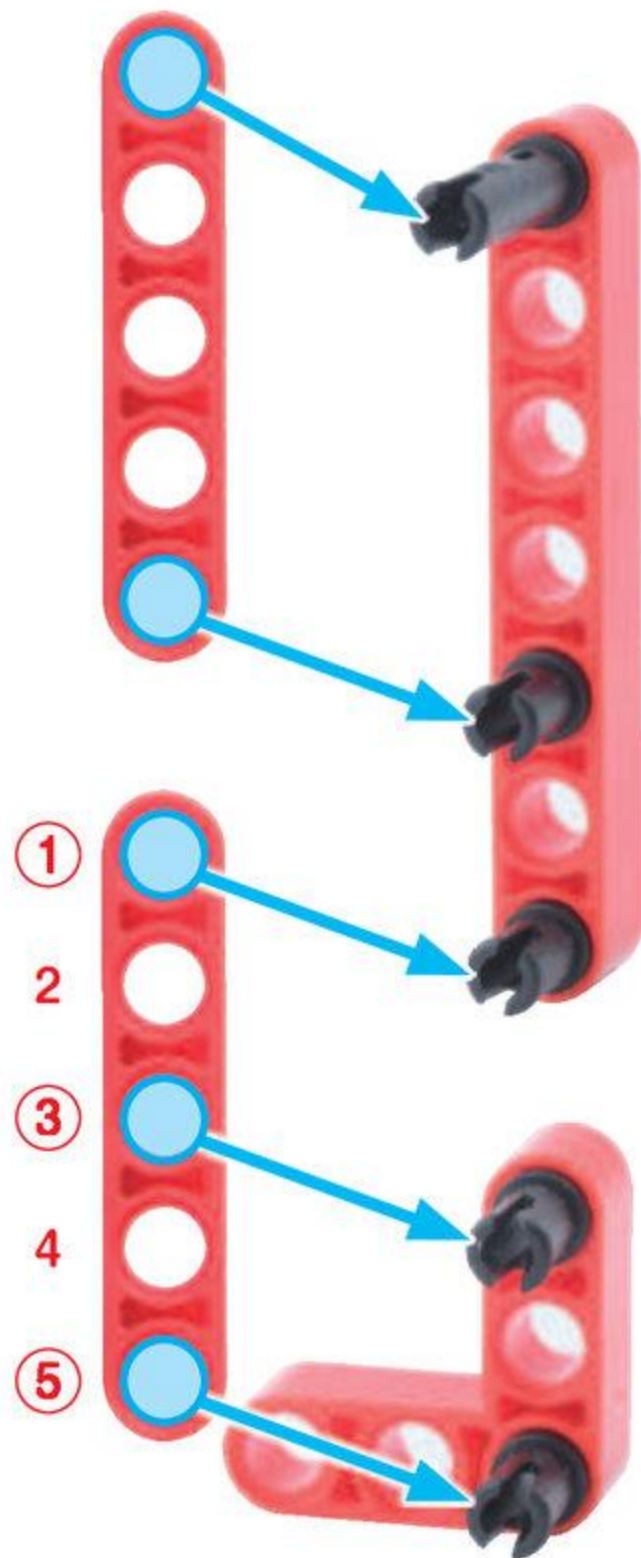

この ^{peg} ^{give} だけ
とびだしているよ

えるろっど
Lロッドの
むきに
ちゅうい

3

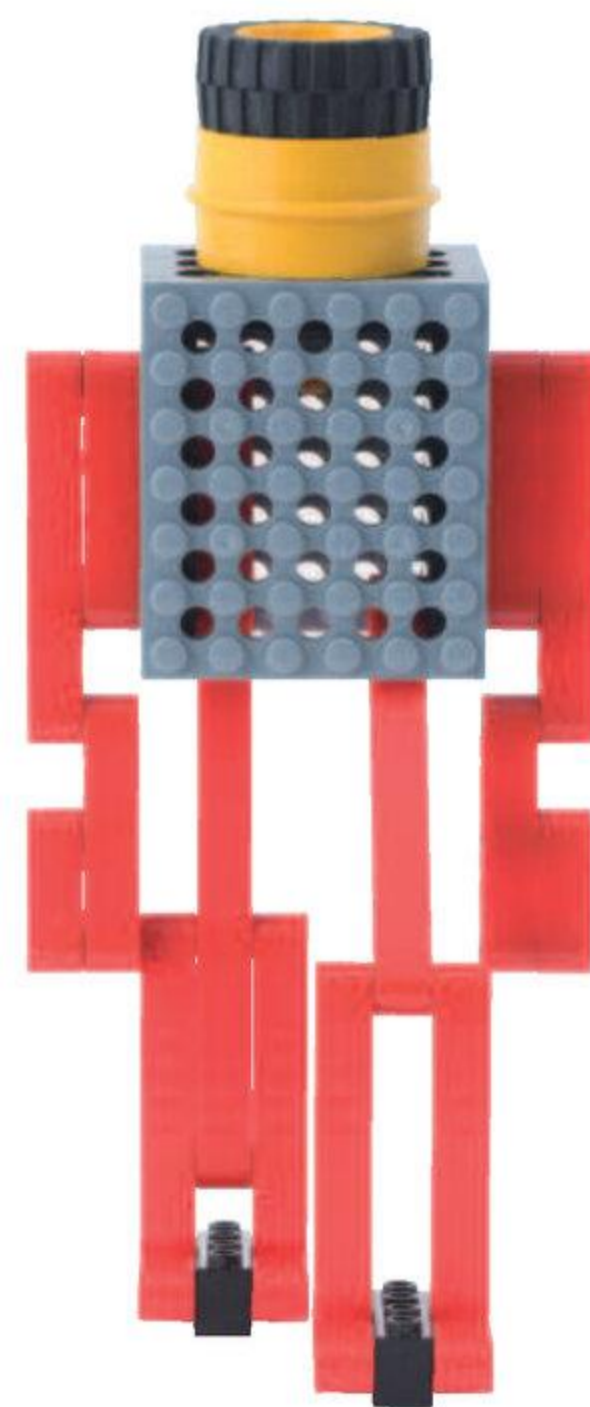
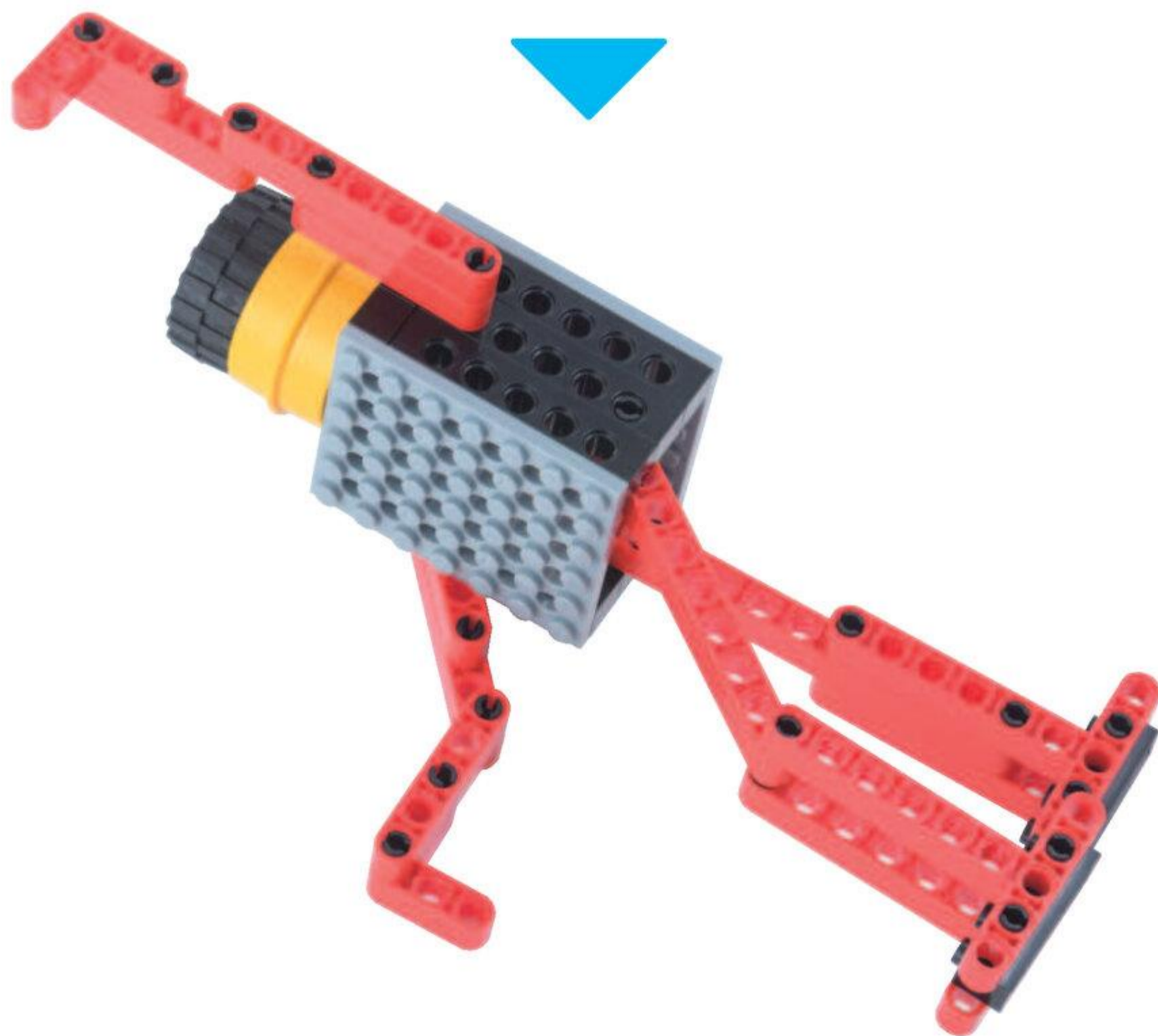

ひとが
かんせい!

やったね!

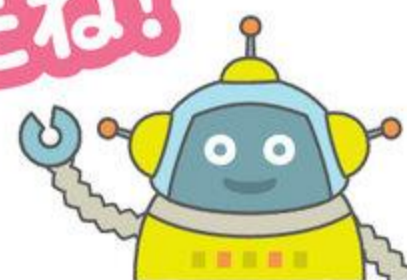

ほそぶれえとろくぼち
細プレート 6 ポチ 2こ



ほそぶれえとよんぼち
細プレート 4 ポチ 2こ



4

はんだる
ハンドルをたてて
すとおっぱあ
ストッパーを
もどしておこう

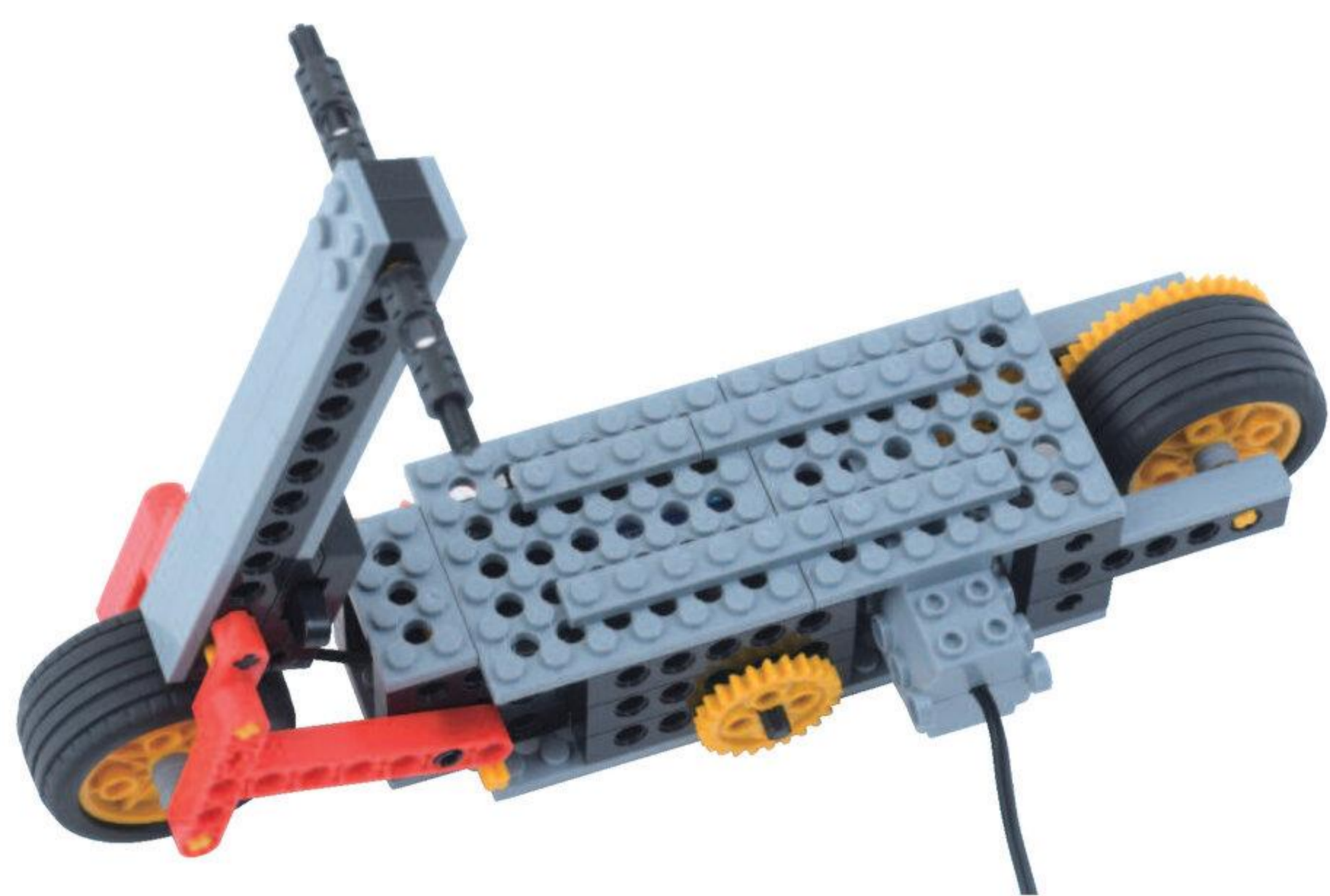
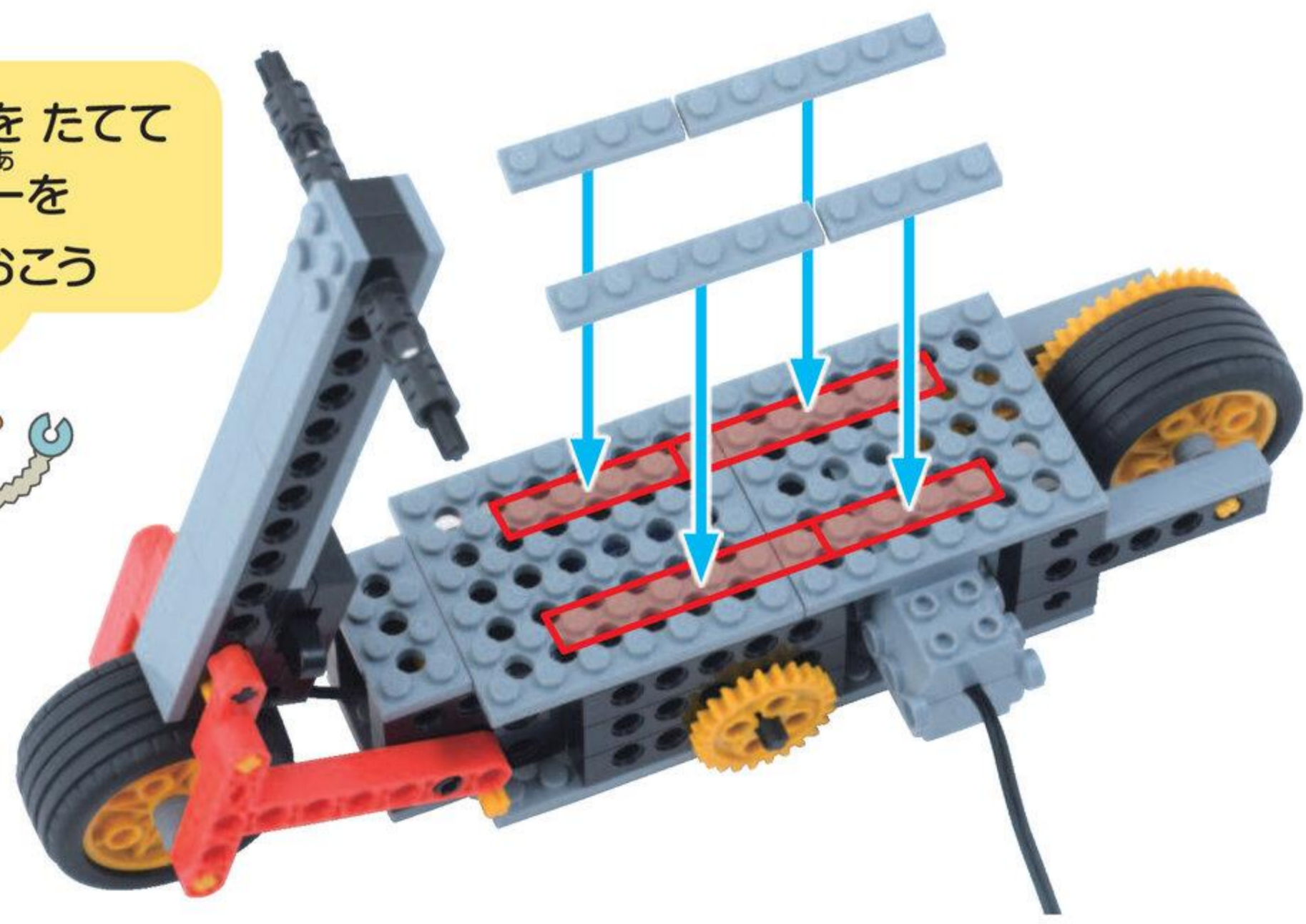
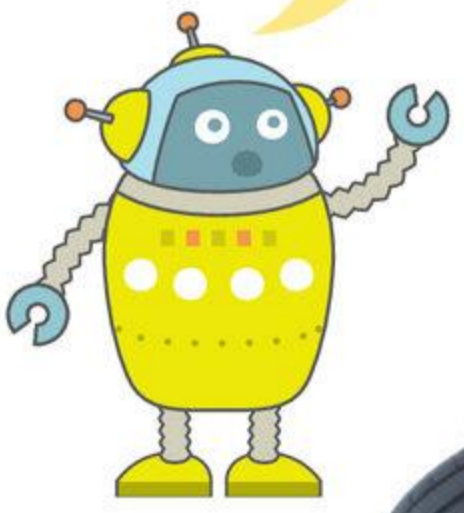

5

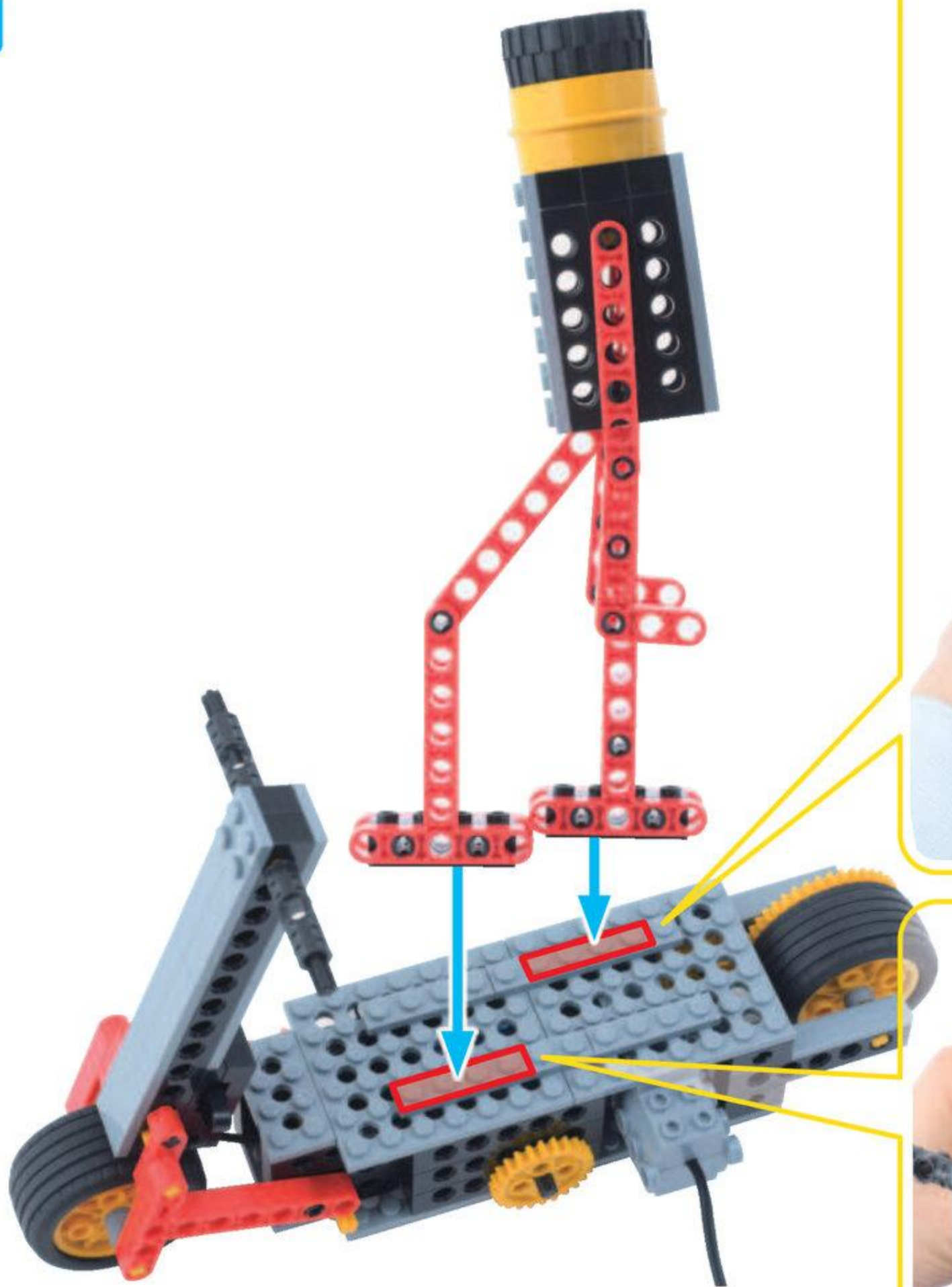

てで もちあげて
ゆびでおさえて
とりつけよう



6

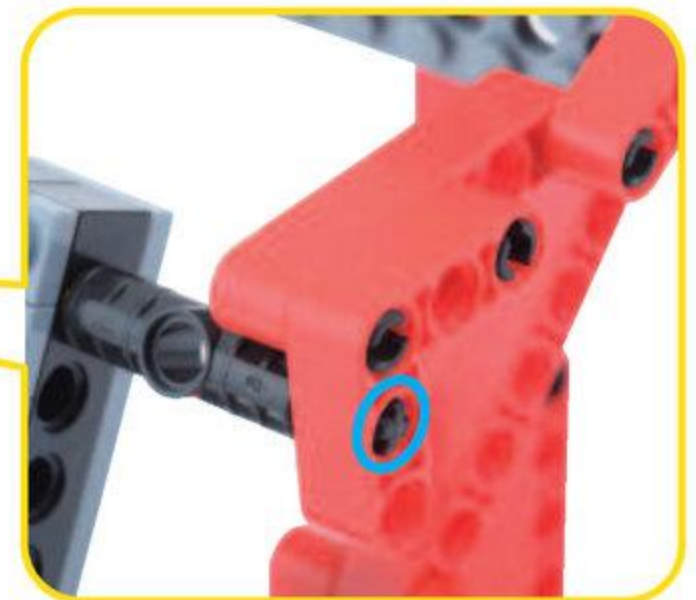

るほっと
ロボットが
かんせい!

よくできました!

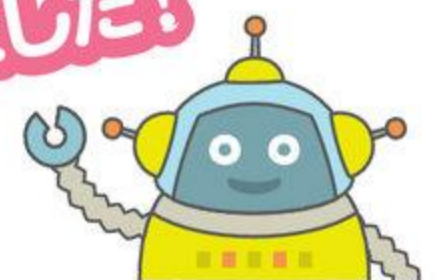

ろぼっと ロボットを うごかそう

めやす 5 ぶん

こおど コードをつなごう

す と っ ぱ あ
ストッパーの
あなのいちを
かくにん

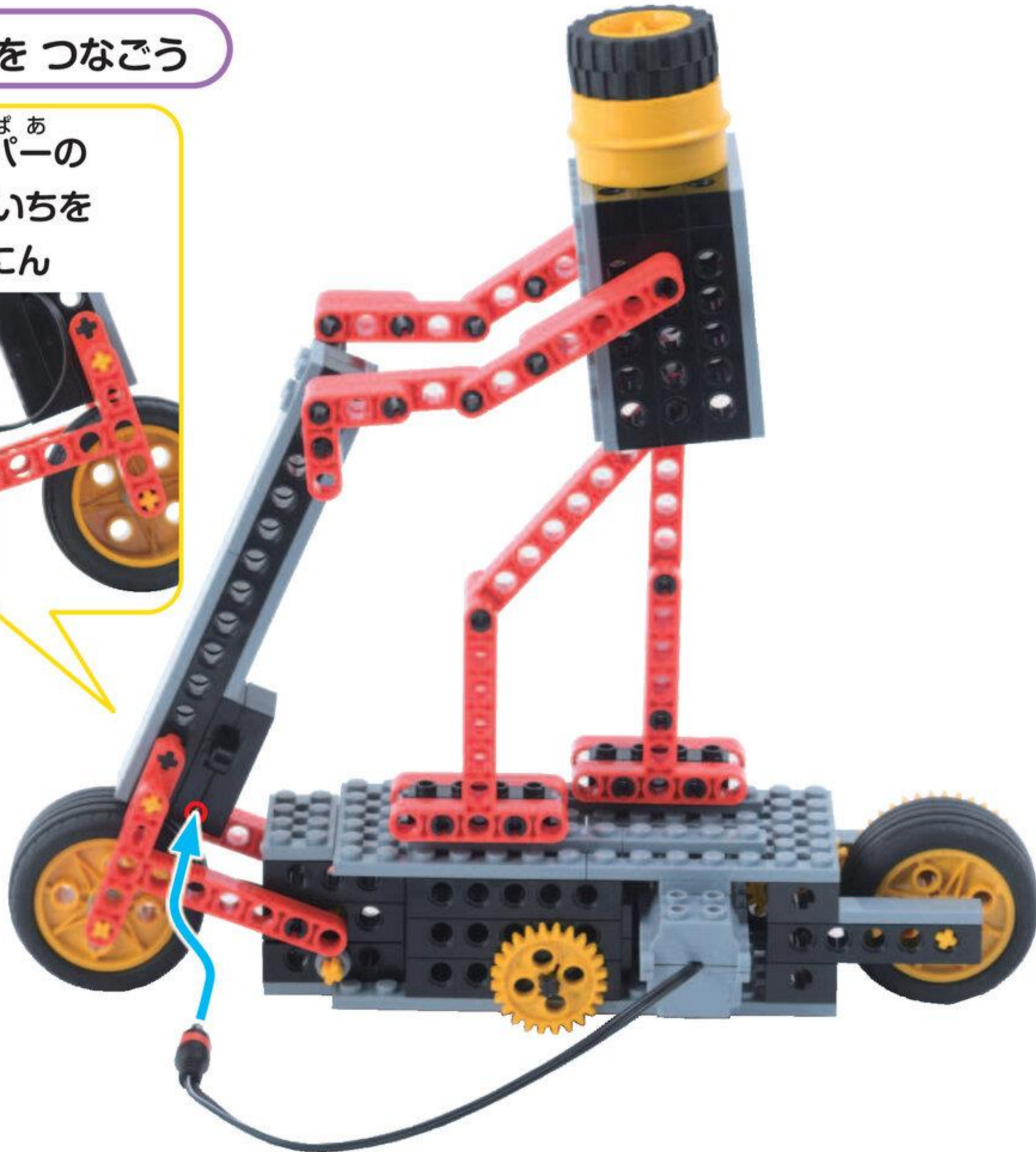
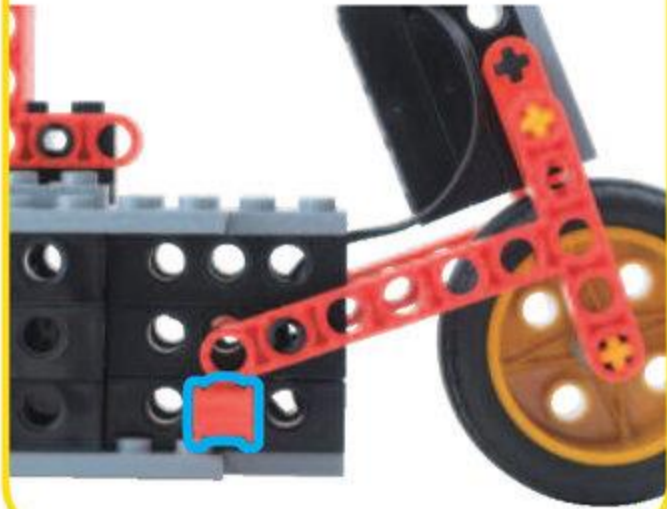

す い っ ち スイッチをいれて うごかそう

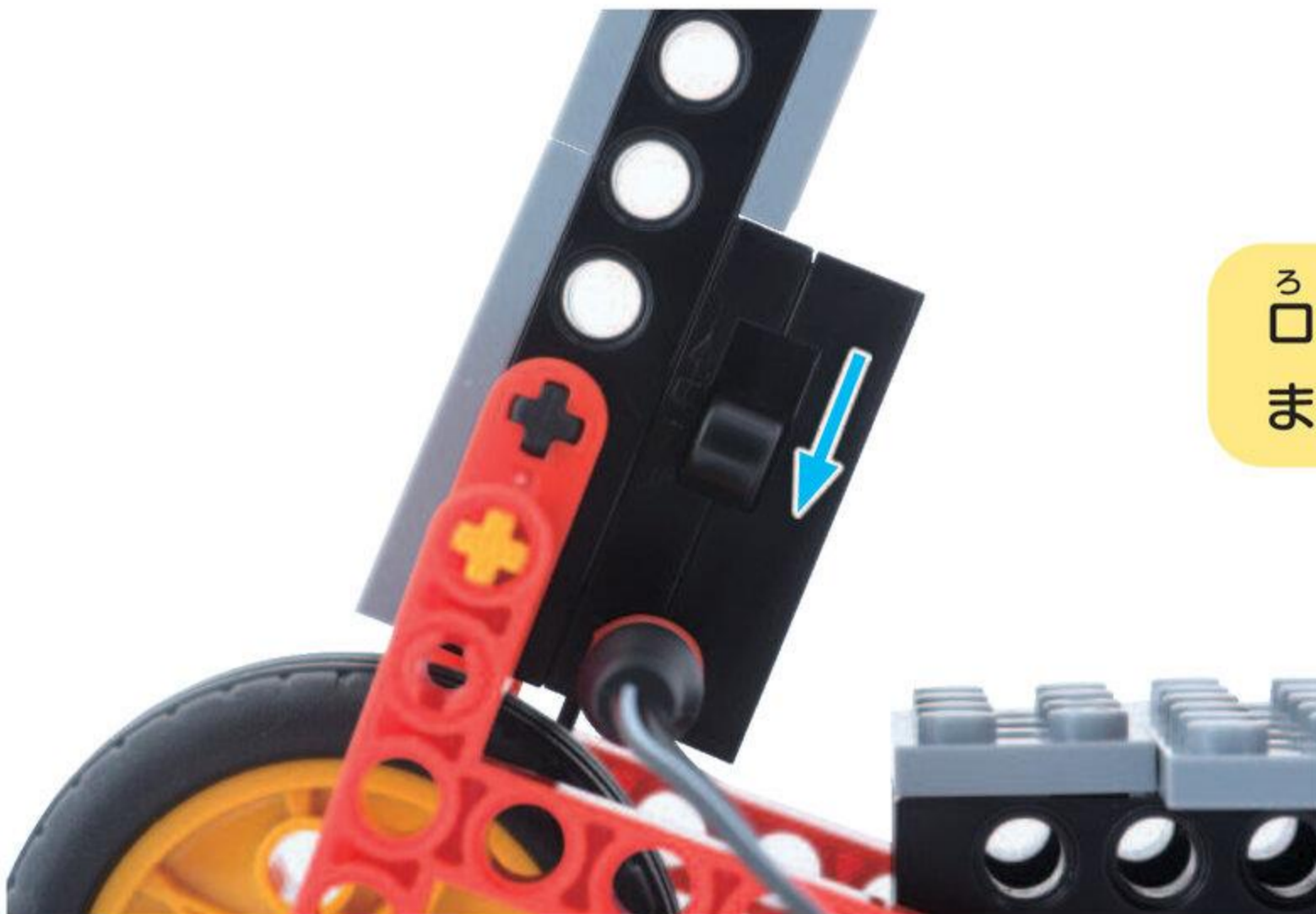

ろぼっと
ロボットは
まえにすすんだかな？

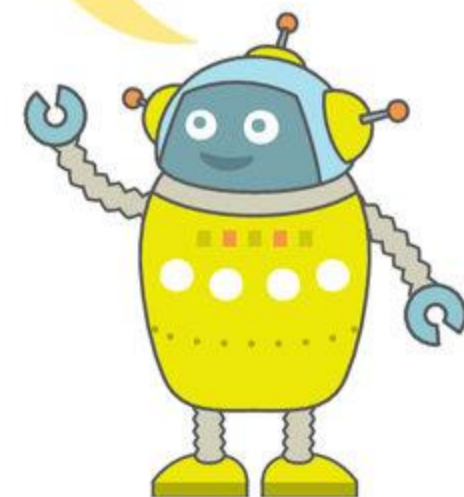

ゴールをつくってはしらせよう

めやす 15 ぶん



あまった^{ばあつ}パーツ^{つか}を使って
ゴール^{つく}を作^{つく}って^{つく}みたよ

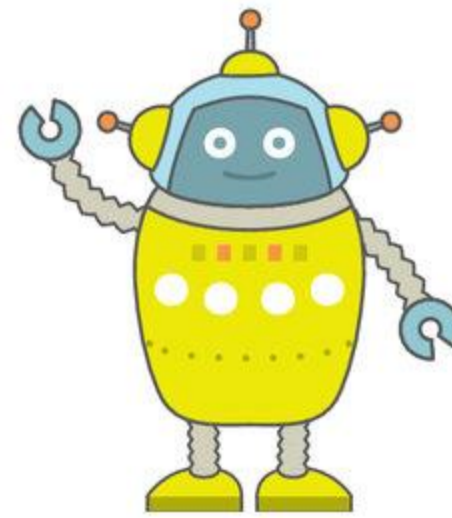

じゆうにかいぞうしてみよう

めやす 10 ぶん

ばあつ
パーツをつかって、じゆうにかいぞうしてみよう！



ひとを
かいぞうしたよ

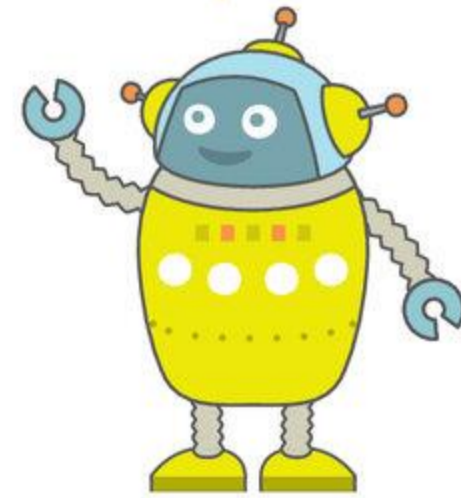

きっくほおど
キックボードを
かいぞうしたよ

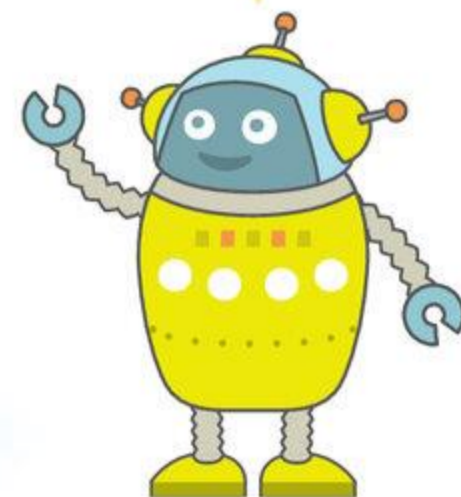

まちがいさがし

めやす 3 ぶん



ちがうところを みつけよう
2つあるよ!

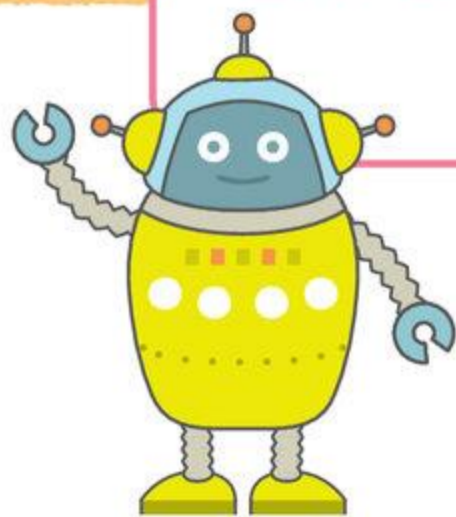

じかいの ロボット

じかい つくる ロボットは

ぴよんぴよんうさぎ

「ロビット」

うさぎの ように
ぴよんぴよん うごくよ

