



ヒューマンアカデミー ジュニア  
STEAMスクール



ロボット教室

# ロボットのきょうかしよ

プレプライマリーコース B

1

おやこで わんつう ワンツウ「かやっくん カヤックン」

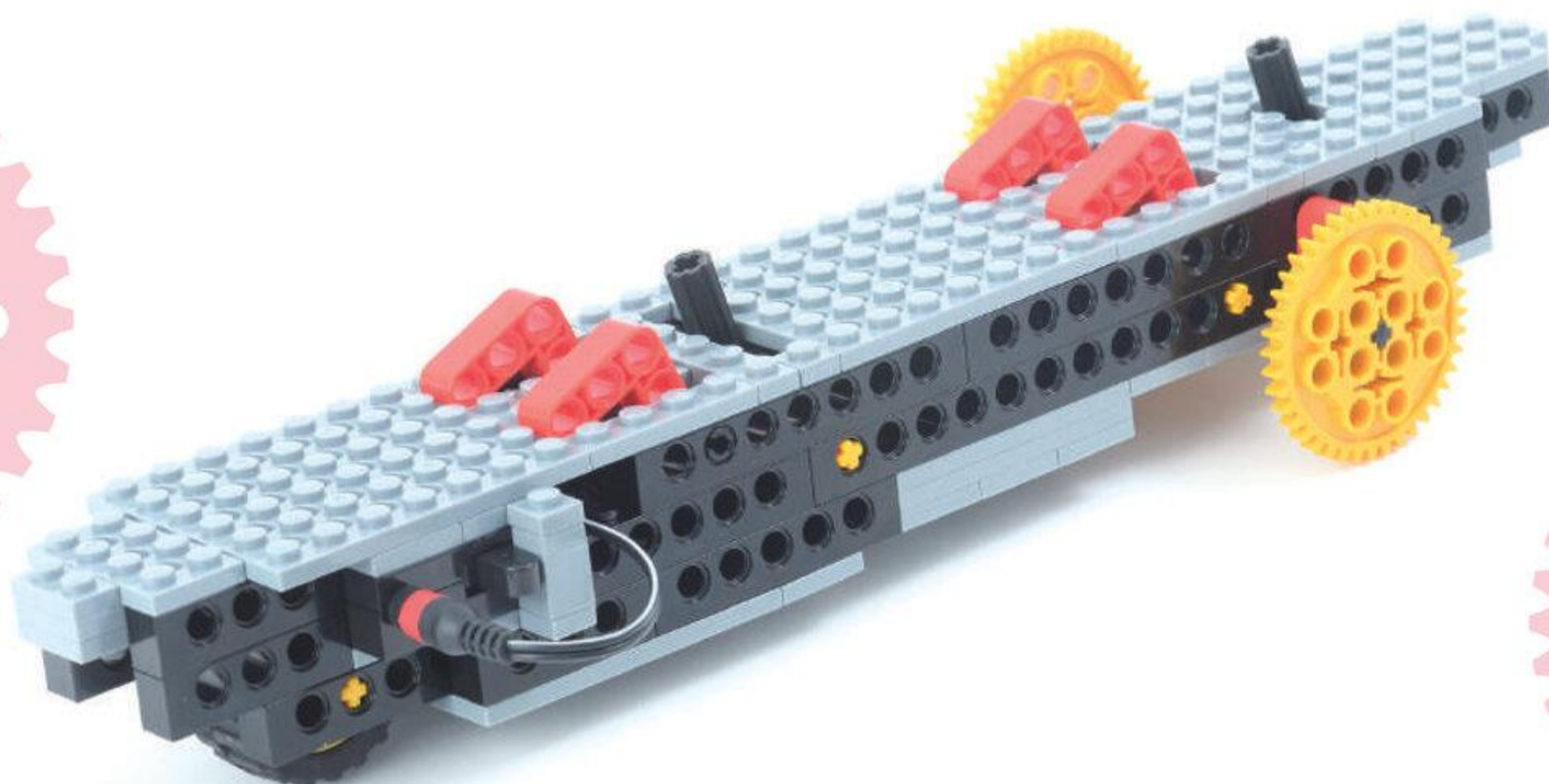

★だい1かい

2023 ねん

9 がつ

にち

なまえ

## ちゅうい しょう

ばあっ パーツや でんきぶひんを あんぜんにつかうために

### ! ばあっ パーツを くちに いれない

くみたてた ばあっ パーツを とりはずすときは、  
ぜったいにはをつかてはいけません。  
ばあっ パーツを のみこんでは いけません。

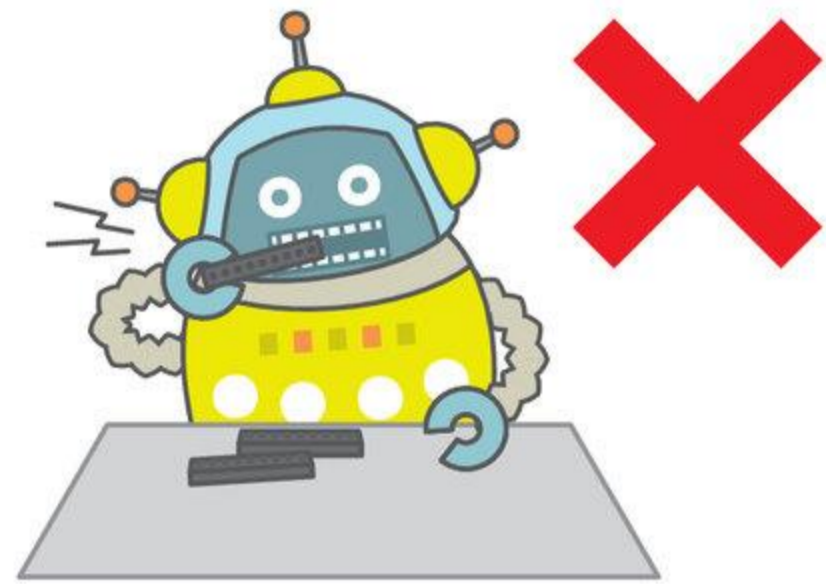

### ! ぶひんを きずつけない

でんきぶひんを はさみや かつたあ カッターなどで  
きずついたり、ばあっ パーツで はさんだりしては  
いけません (しゃしん 1)。

こおど や けえぶる コードや ケーブルは、おりまげたり、  
ひっぱったりしては いけません。

ぶらぐ の むきさしは、ぶらぐぶぶんを  
もって おこないましょう (しゃしん 2)。

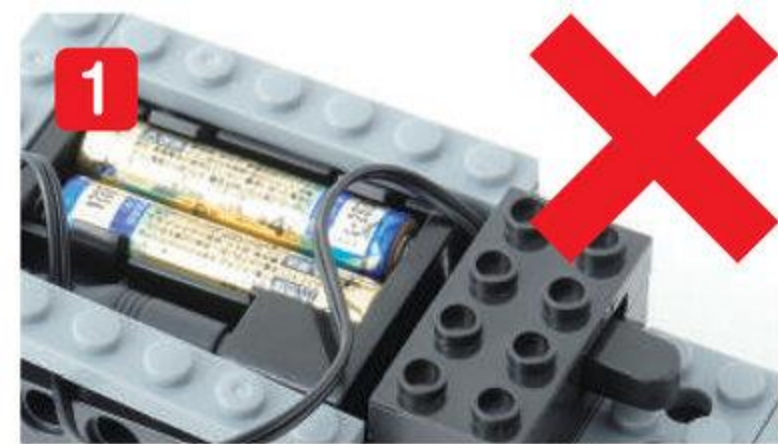

### ! あつい・におうとき、へんなおとが するとき

ろほっと ロボットを うごかしたときに、でんちや でんきぶひんが  
あつくなったり、へんな においが したり、いつもと ちがうおとが  
したばあいは、すぐに ロボットを とめ、せんせいに しらせましょう。  
ぬれたてで でんきぶひんを さわってはいけません。

もくじ

だい 1 かい

ろぼっとの ぶんかい	3	10ぶん
かんがえてみよう	3~4	
きょうの パーツ	5	12ぶん
きょうの よてい	6	
くみたて		
1. ふね (まんなか)	7~27	60ぶん
2. ふね (まえ)	28~40	
3. ふね (うしろ)	41~50	
ろぼっとを うごかそう	51	
くいす	52	3ぶん
かたづけ		5ぶん

ふるっく  
ブロックはずし



つかうと べんりだよ

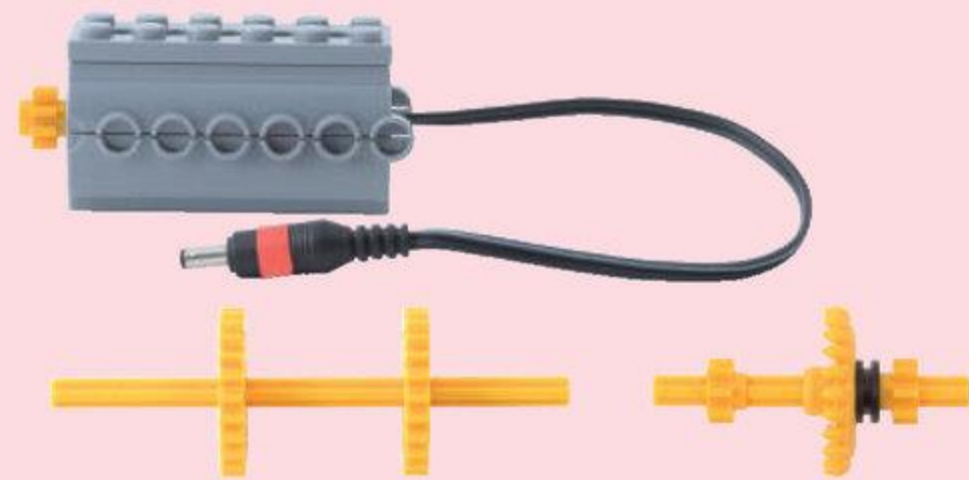

このセットは くずさないでね! またつかうよ



かんがえてみよう

めやす 5 ぶん



ふねは どうやって すすんでいるかな?





みずをおしてすすんでいるよ。



お お る  
オールをこいでみずをうしろにおすと  
はんどうでふねはまえにすすむよ。

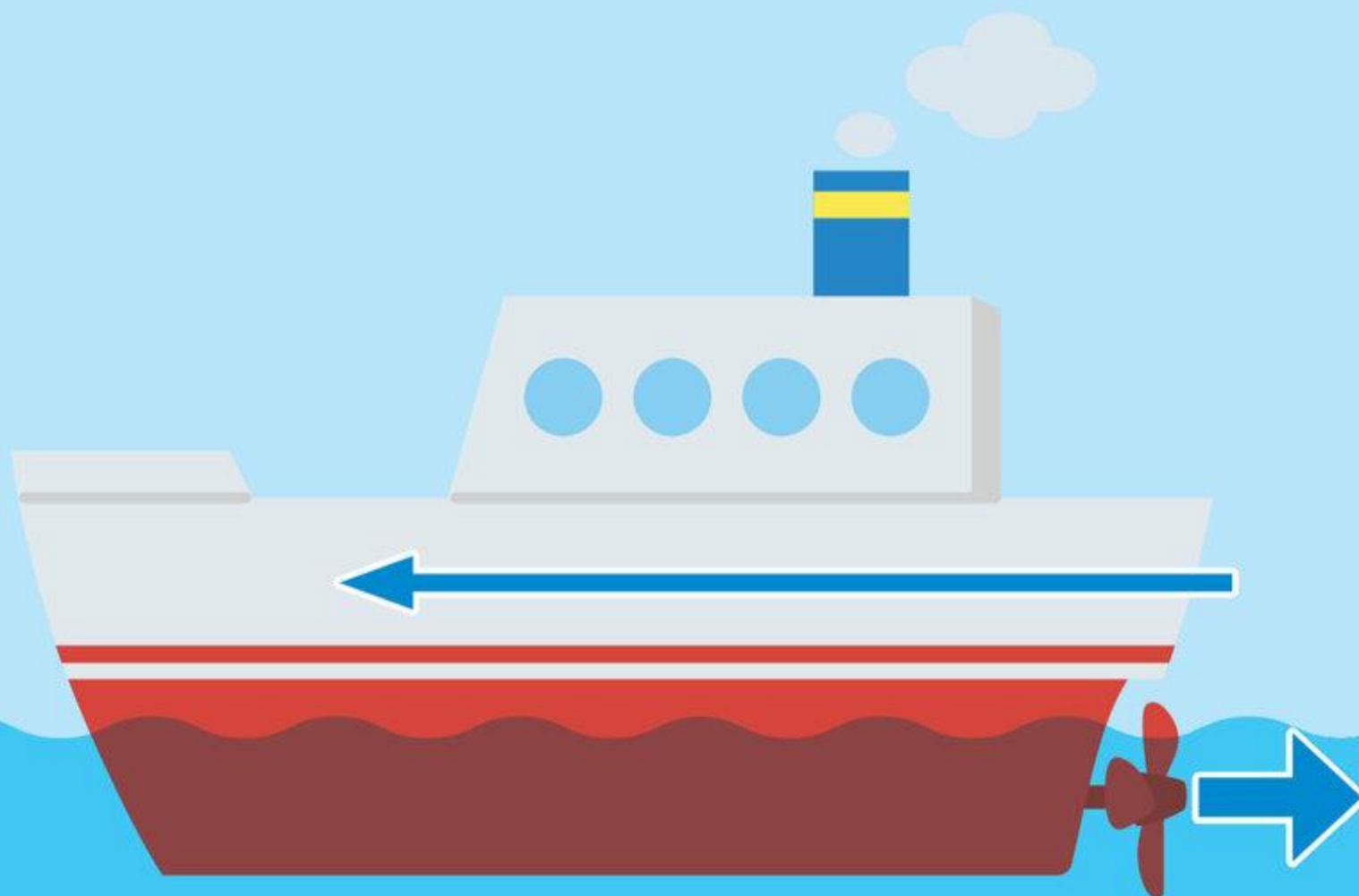

す くり ゅ う  
「スクリュー」でみずをおすふねもあるよ。

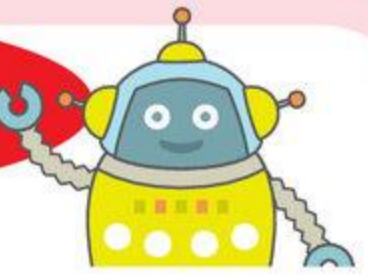

めやす **5** ふん

しゃふとじょいんと  
**シャフトジョイント**

あなしゃふとじょいんと  
**アナシャフトジョイント**

### パーツをみつけよう



### とくちょう

しゃふとじょいんと  
シャフトジョイント



あな  
+のかたちのアナ

あなしゃふとじょいんと  
アナシャフトジョイント



あな  
○のかたちのアナ

### マスターしよう

あなしゃふと  
アナにシャフトをさしてみよう。なんぼんさせるかな？

しゃふとじょいんとあな  
●シャフトジョイントはアナがつながっていないよ。

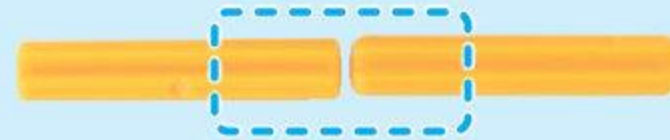

あなしゃふとじょいんと  
●アナシャフトジョイントは  
つながっているアナとつながっていないアナがあるよ。

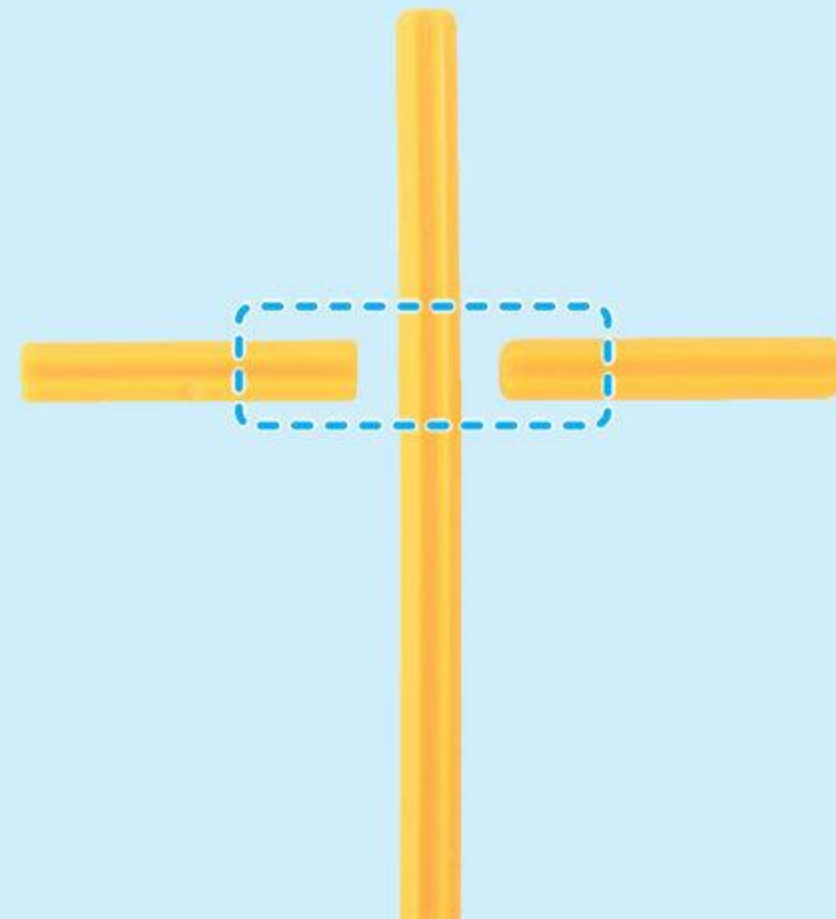
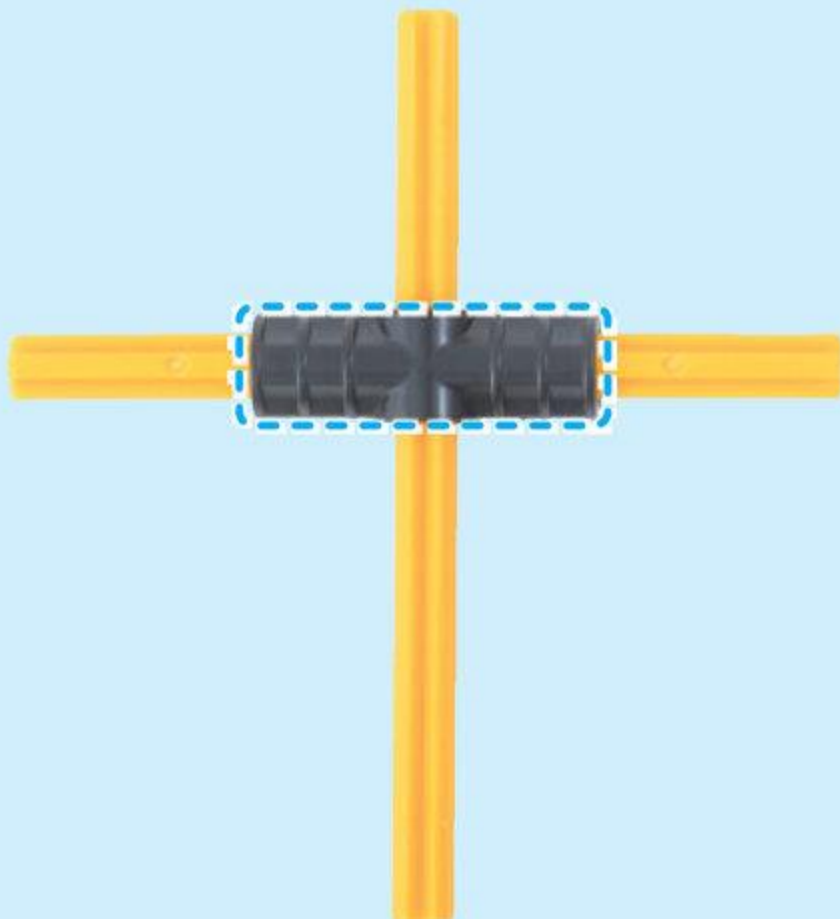

# きょうの よてい

めやす 2 ふん

このじゅんばんでつくるよ!

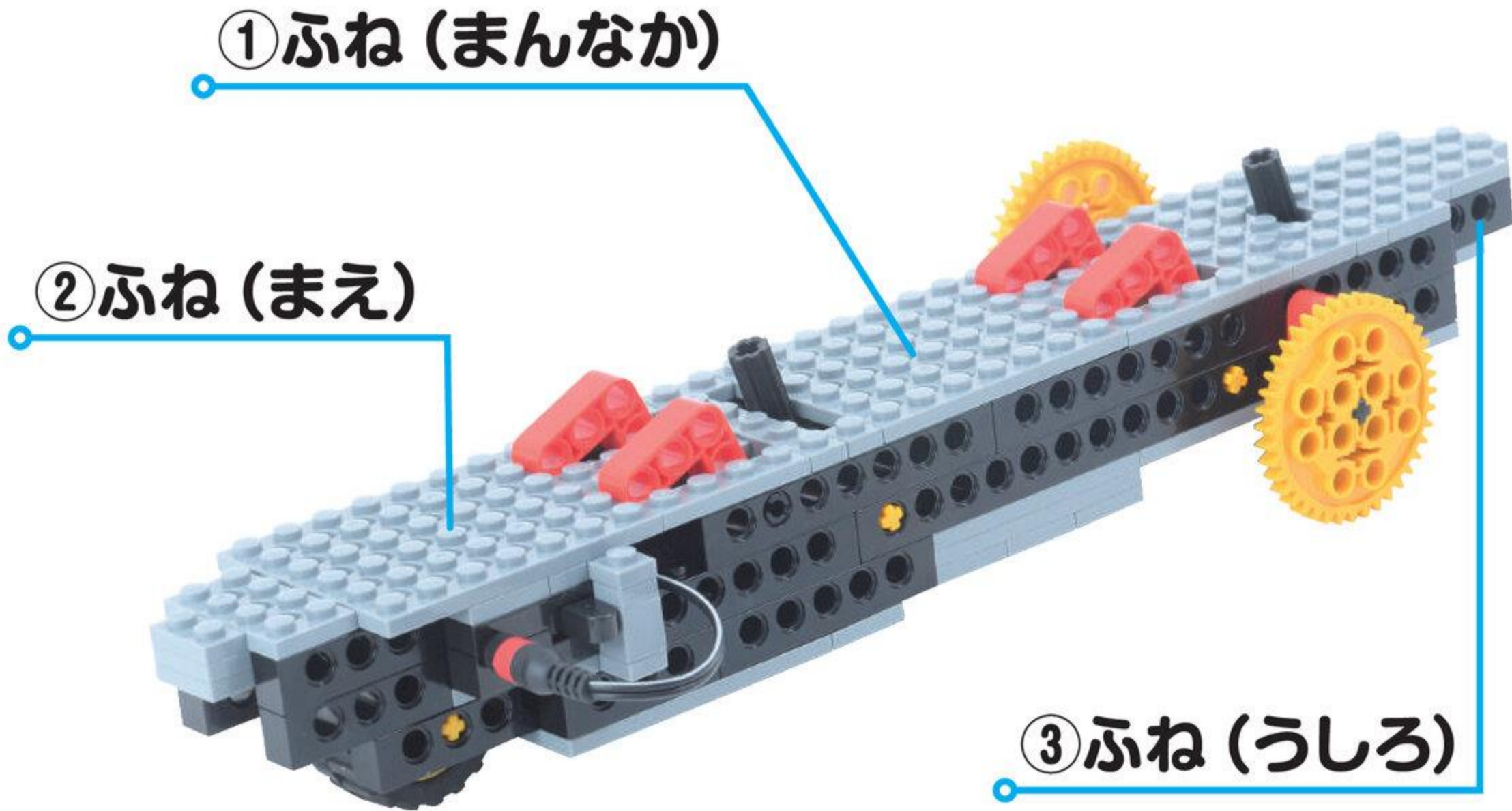

①ふね (まんなか)



②ふね (まえ)

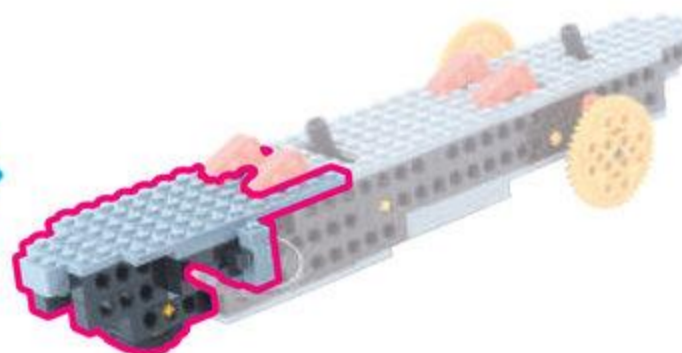

③ふね (うしろ)



# 1 ふね (まんなか)

めやす 25 ふん



ほそぶれえとろくほち  
細プレート 6 ポチ **2**こ



ふとぶれえとろくほち  
太プレート 6 ポチ **3**こ



1

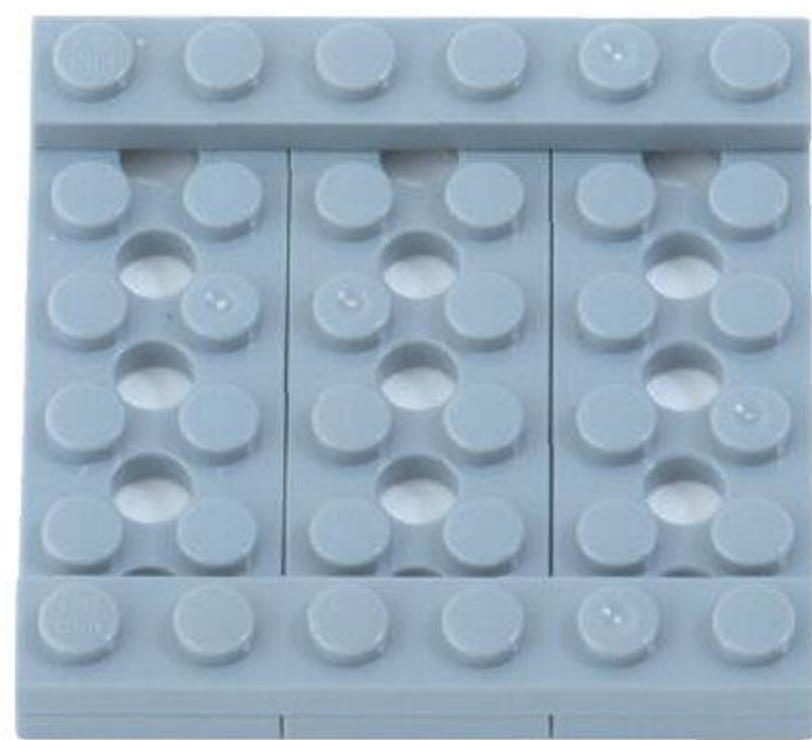
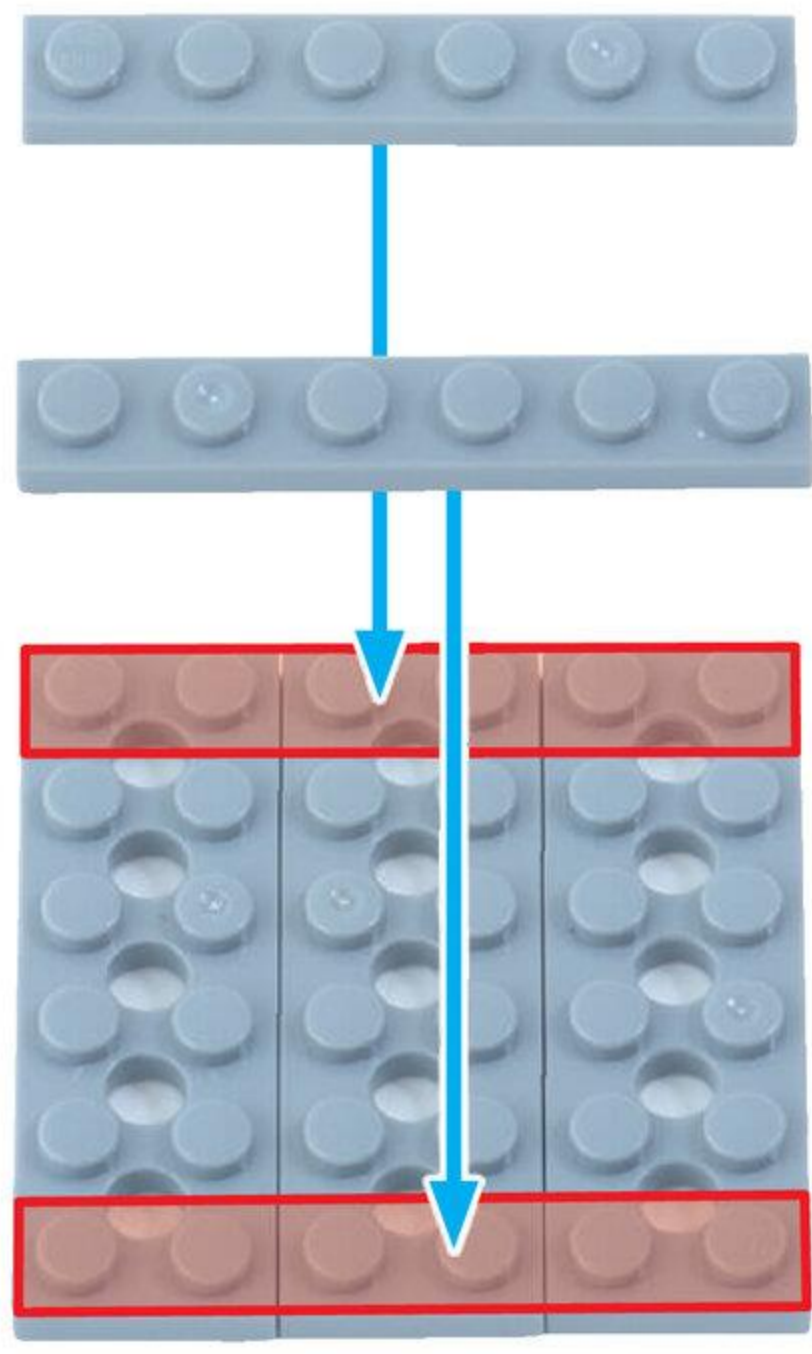

びいむじゅうん ぼち  
ビーム 14 ポチ 1こ

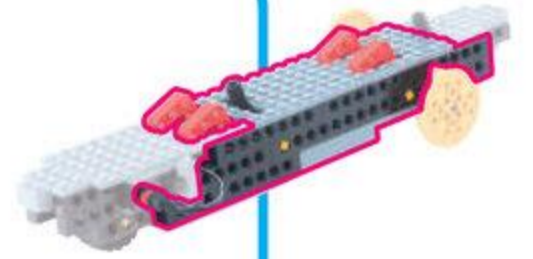

びいむ ぶん ぼち  
ビーム 4 ポチ 1こ



ほそぶれえとろく ぼち  
細プレート 6 ポチ 2こ



ほそぶれえとに ぼち  
細プレート 2 ポチ 1こ



2

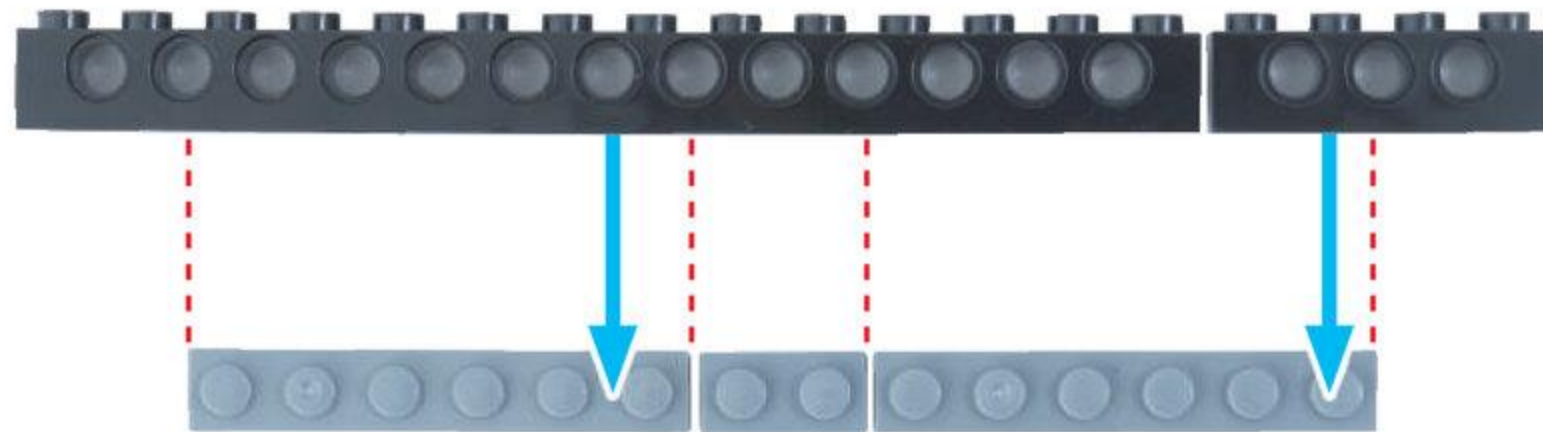

びいむ ぼち  
ビームが 2 ポチぶん はみでるよ

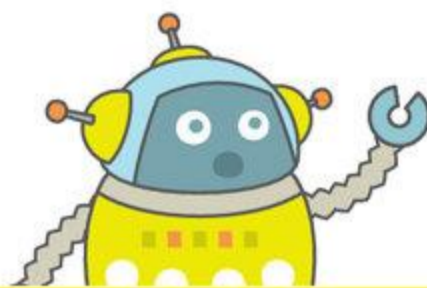



びいむはちほち  
ビーム 8 ポチ 1こ



びいむよんほち  
ビーム 4 ポチ 1こ



びいむろくほち  
ビーム 6 ポチ 1こ



3

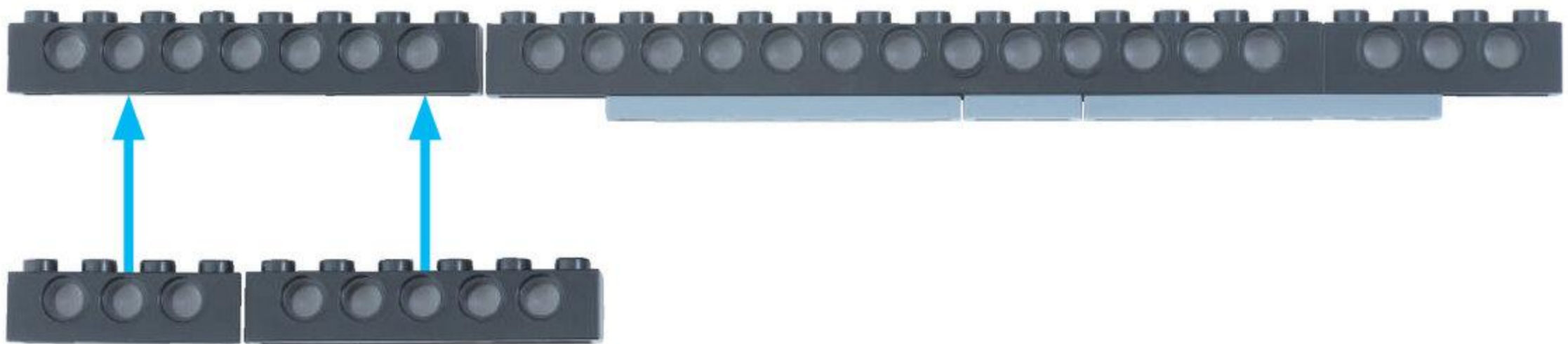

4

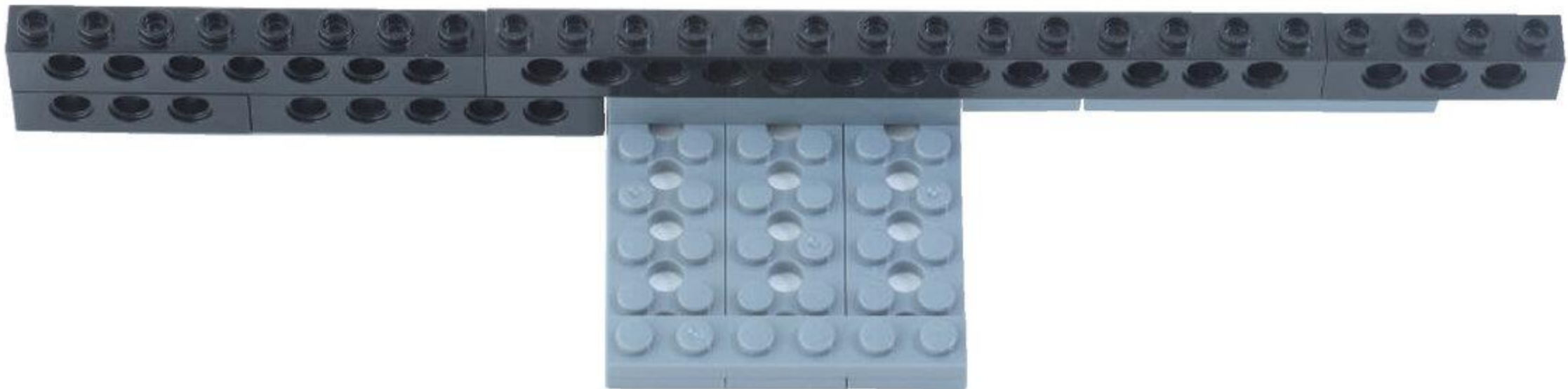
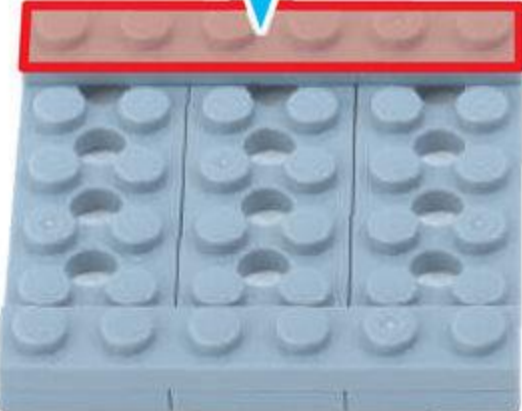
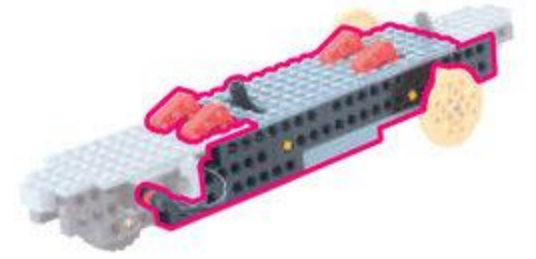

ぶっしゅ  
ブッシュ 2こ



しゃふと 3く ぼち  
シャフト 6ポチ 1こ



ていじょいんと  
T ジョイント 1こ



しゃふとじょいんと  
シャフトジョイント 1こ



くろしゃふと いってんご ぼち  
黒シャフト 1.5ポチ 1こ



みじかい



ながい



5

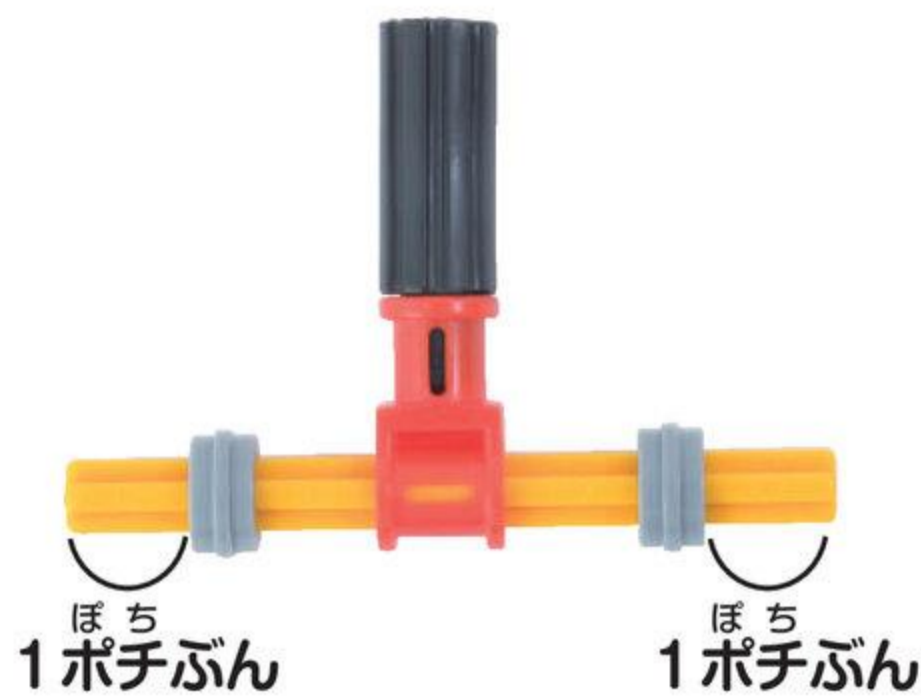
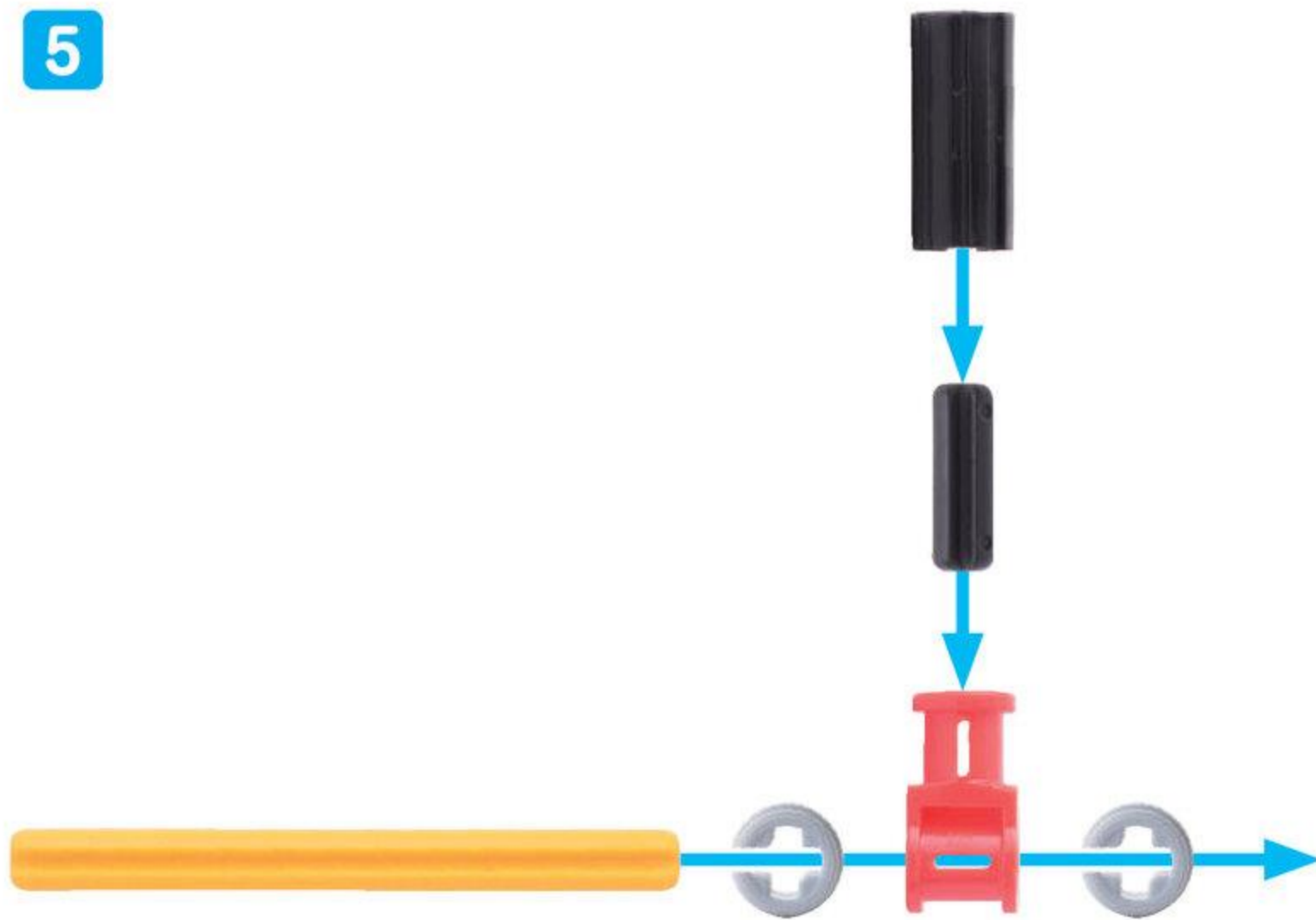

しゃふと はち ぼち  
シャフト 8 ポチ 1こ

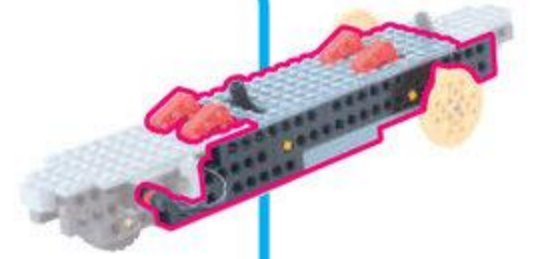

ぎあ えむ  
ギア M うす 2こ

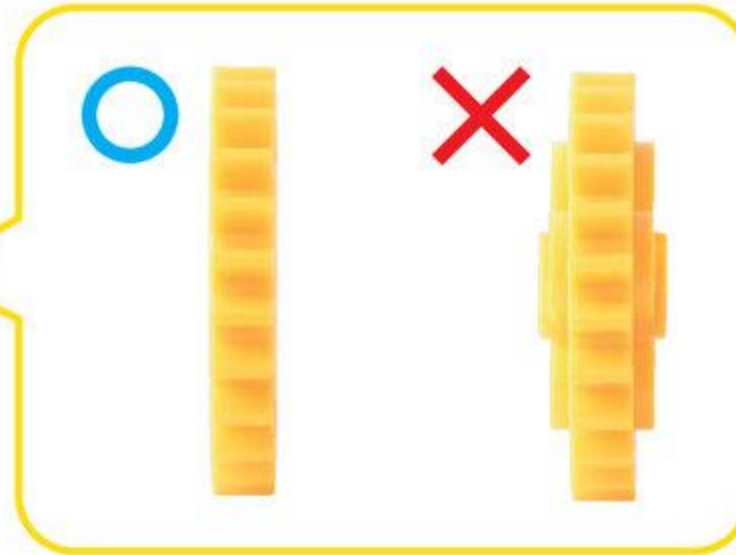
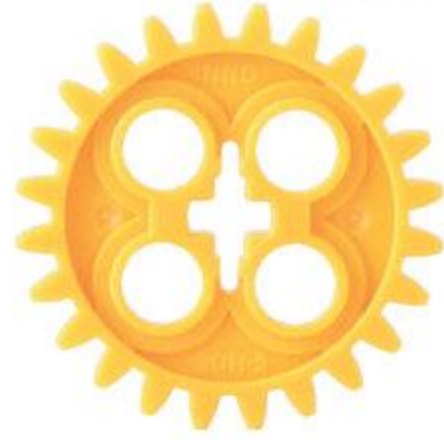

6

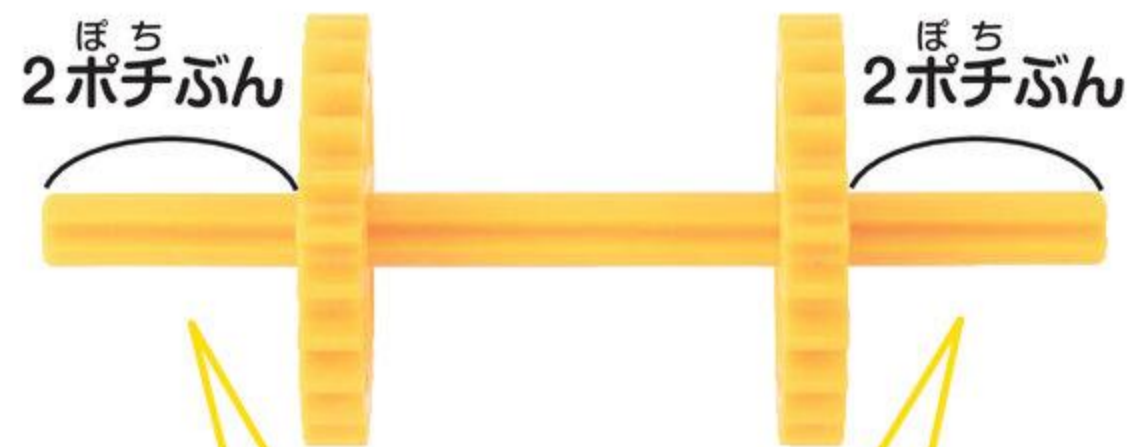

たてにかさねた <sup>びいむ</sup> ビームをつかってあけることもできるよ!

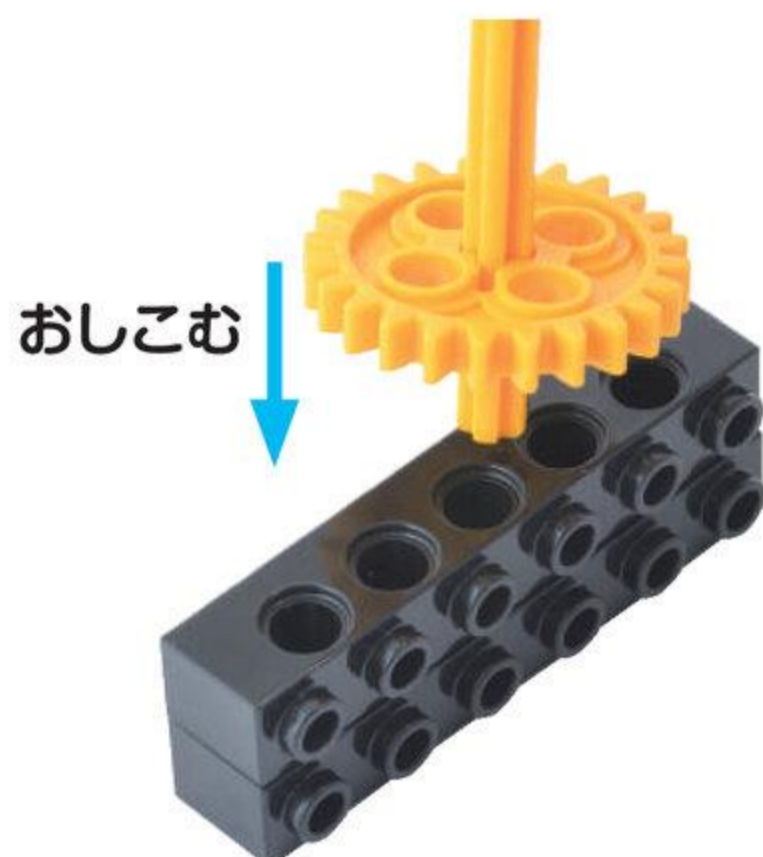

ぎあせつと  
ギアセット



7

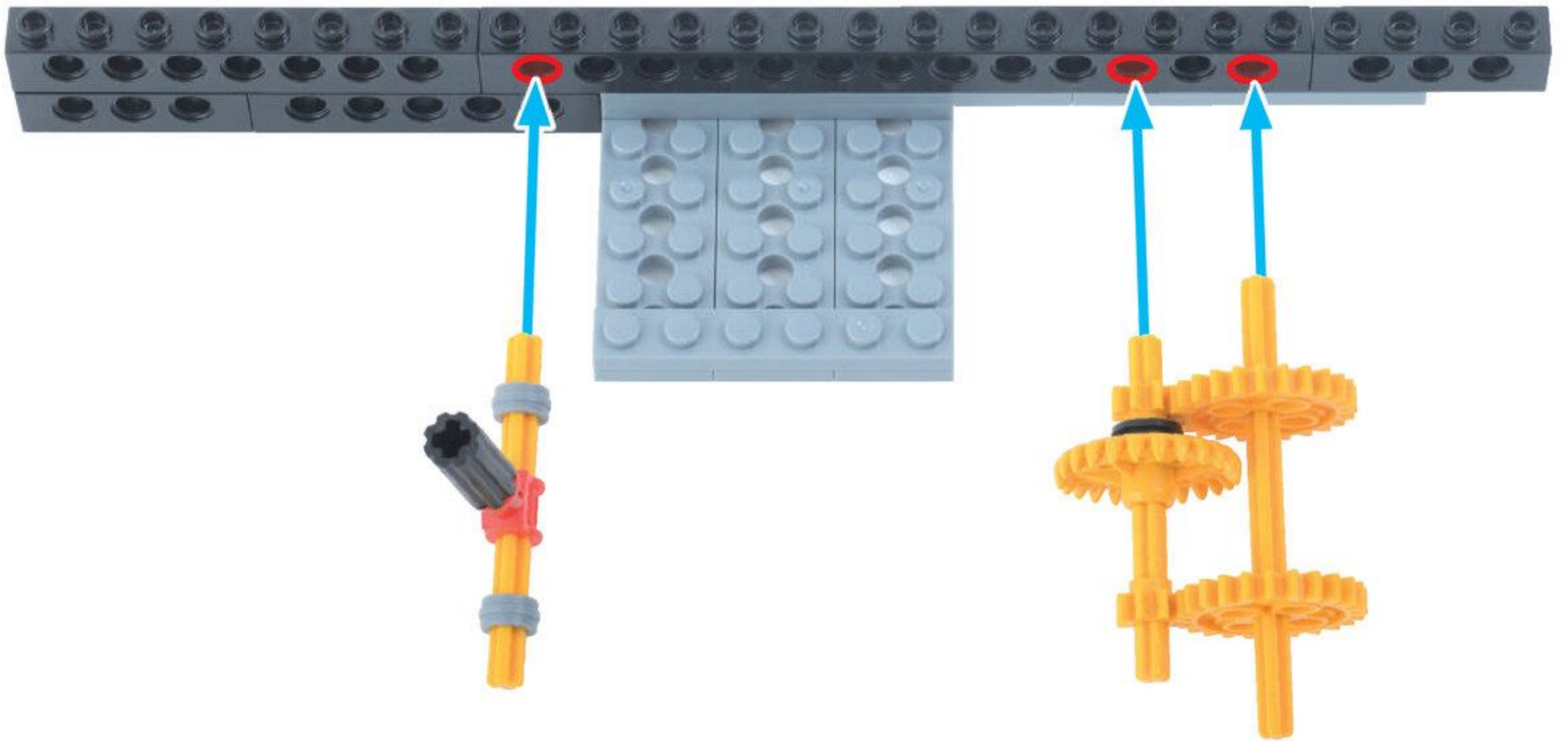

もおたあせつと  
モーターセット



「じぜんくみため  
パーツ」を  
つかうよ!

8

はずす

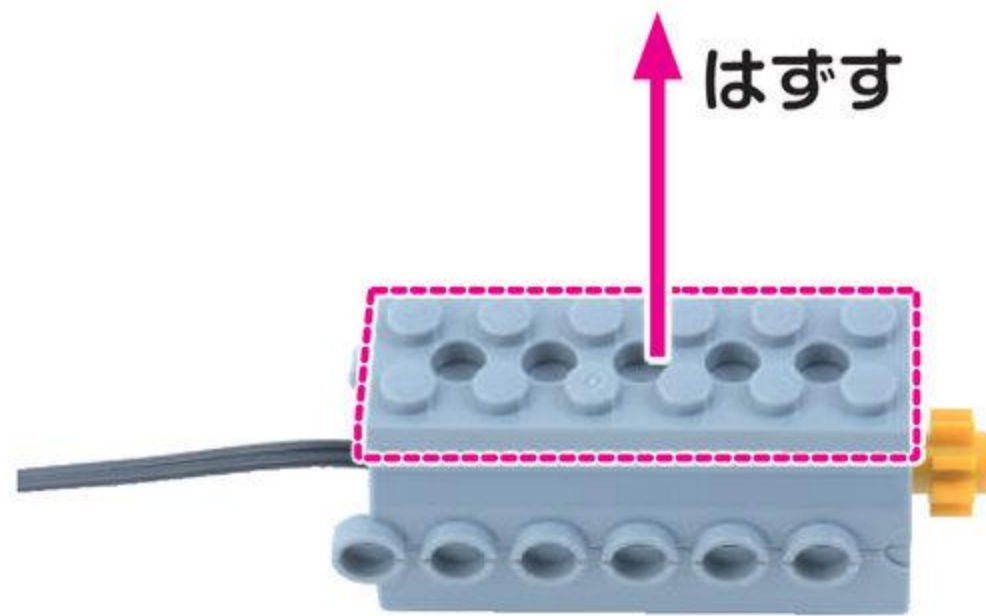

はずした<sup>ばあつ</sup>パーツは  
しまおう

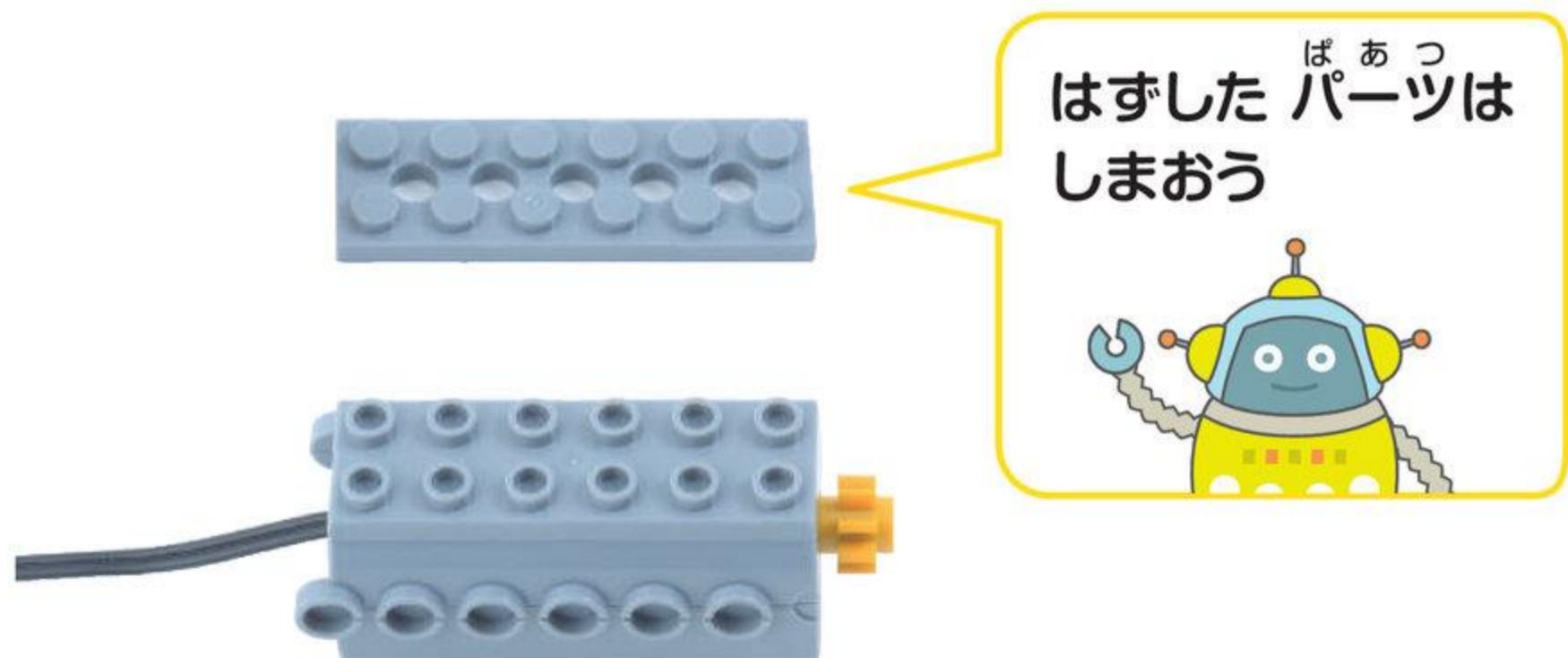

9

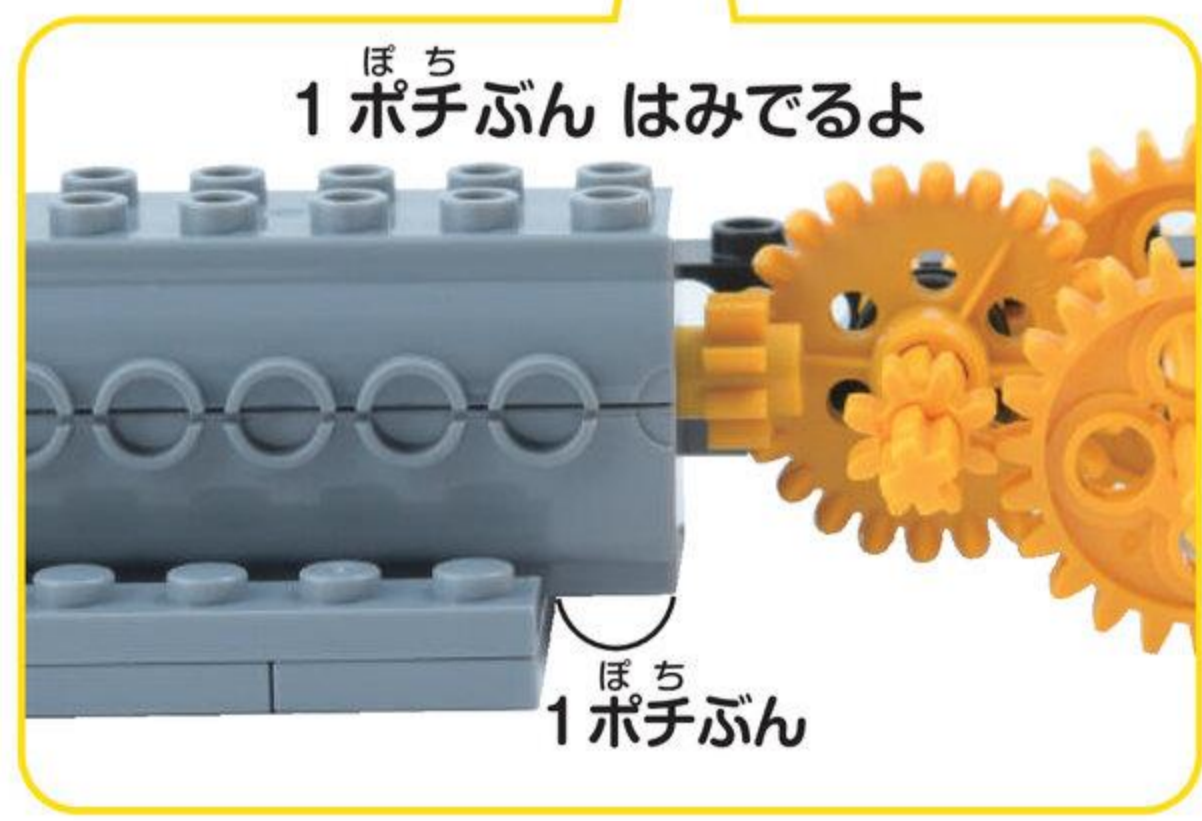
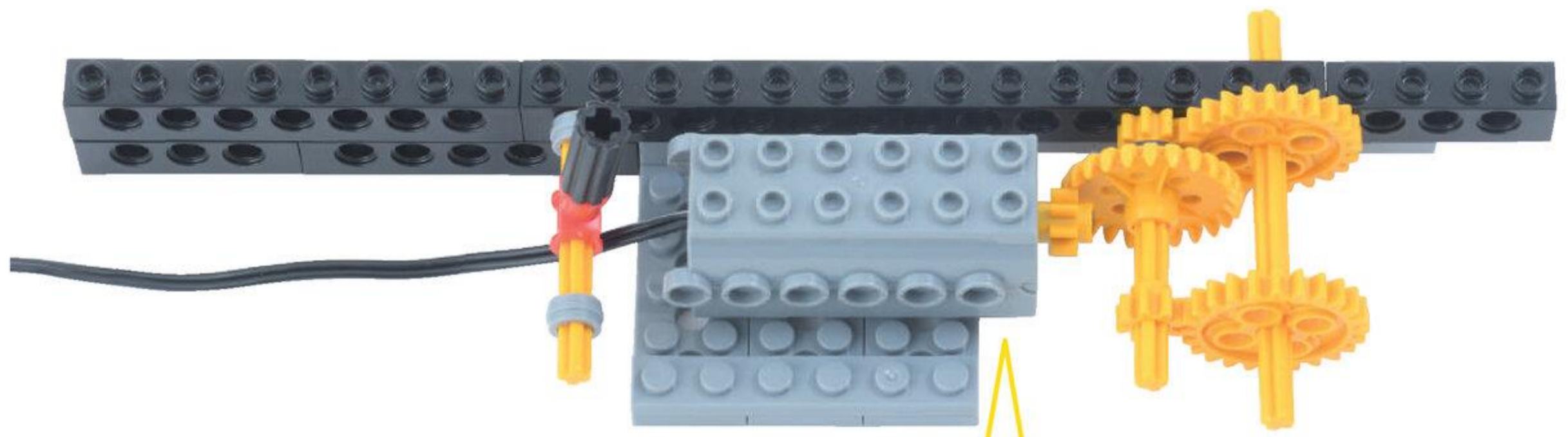
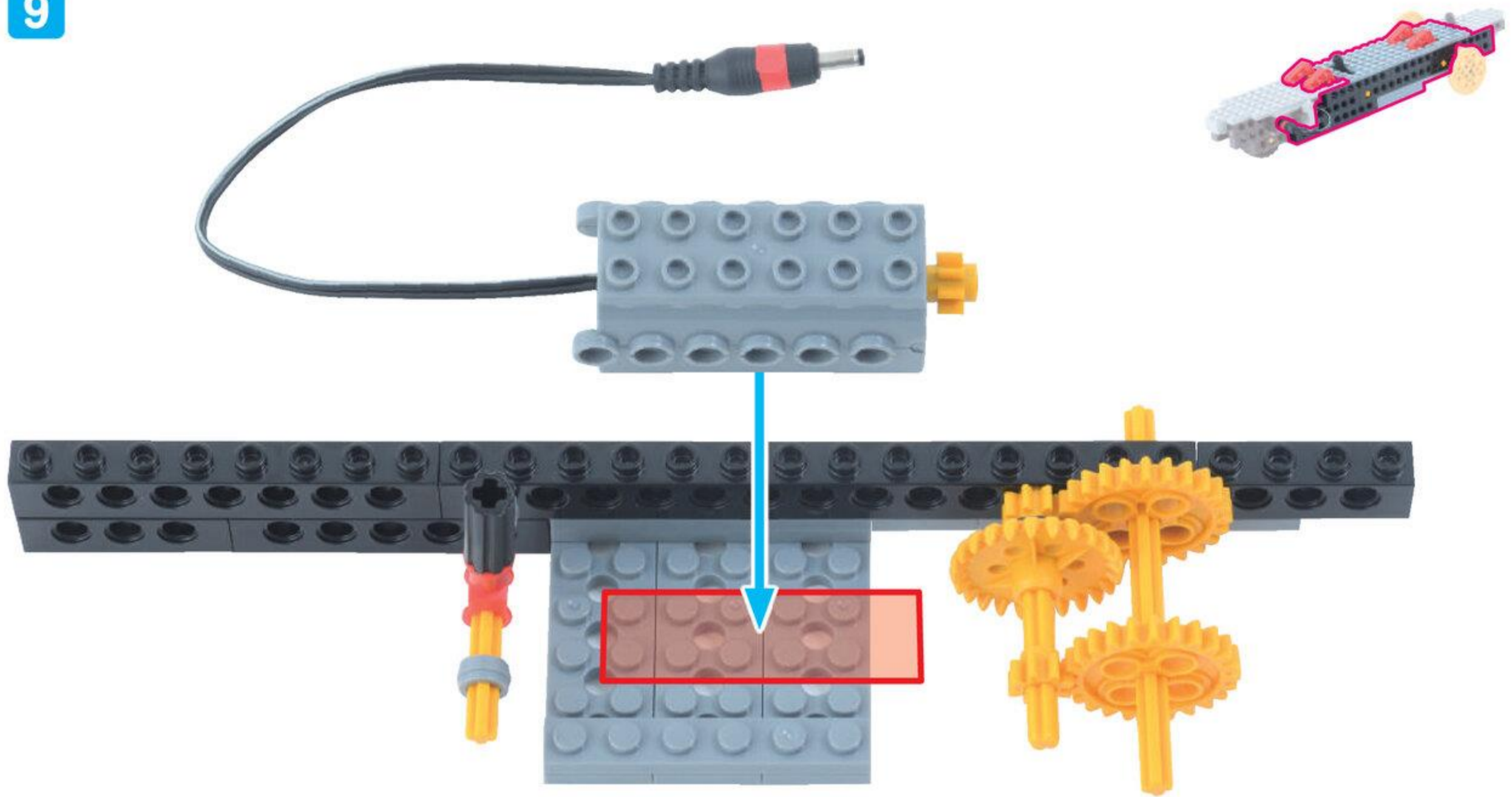

びいむじゅうん ぼち  
 ビーム 14 ポチ 1こ

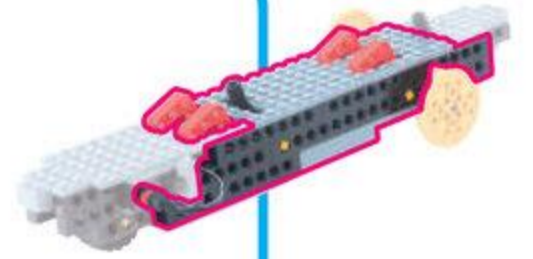

びいむ ん ぼち  
 ビーム 4 ポチ 1こ



びいむ ろく ぼち  
 ビーム 6 ポチ 1こ



ほそぶれえとろく ぼち  
 細プレート 6 ポチ 2こ



ほそぶれえとに ぼち  
 細プレート 2 ポチ 1こ



10

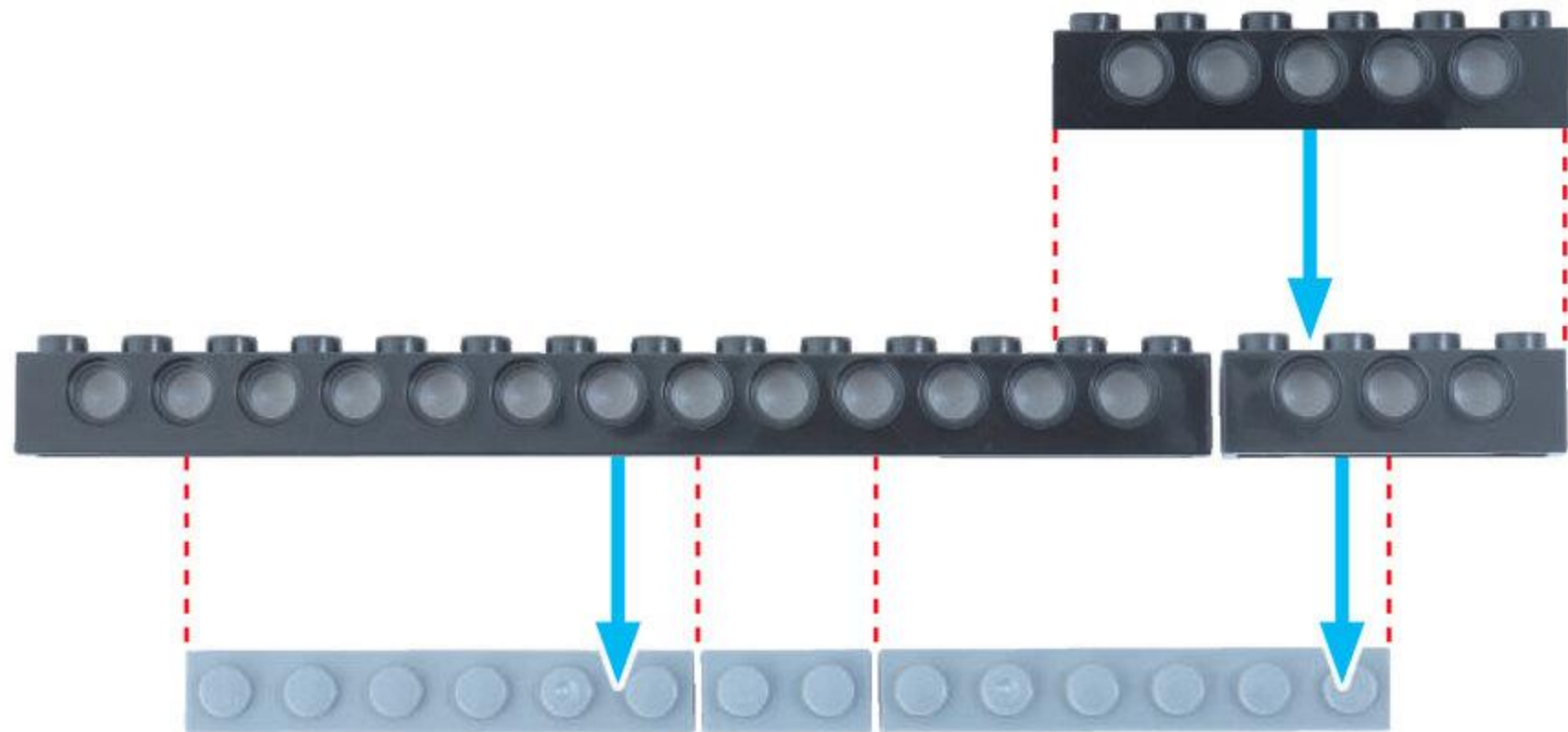

ぼち  
 2ポチぶん

ぼち  
 2ポチぶん

びいむ ぼち  
 ビームが 2ポチぶん はみでるよ

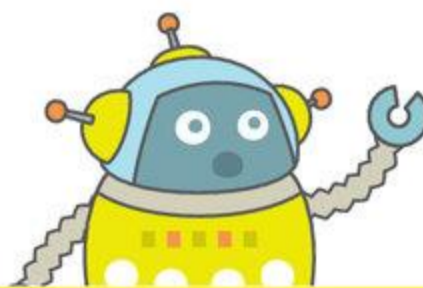



びいむろくほち  
ビーム6ポチ 2こ



びいむよんほち  
ビーム4ポチ 1こ



11

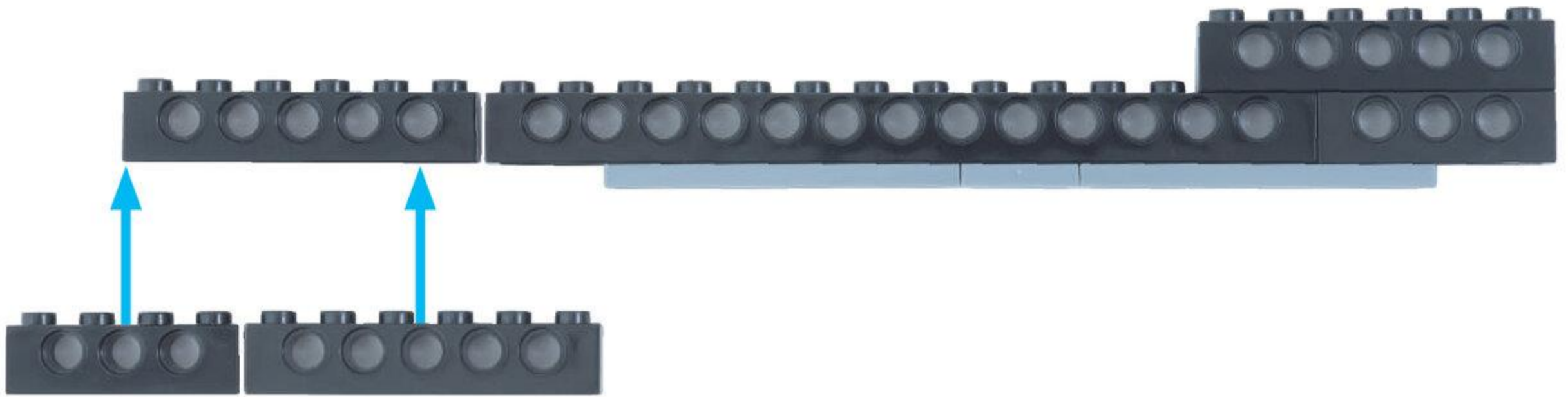

12

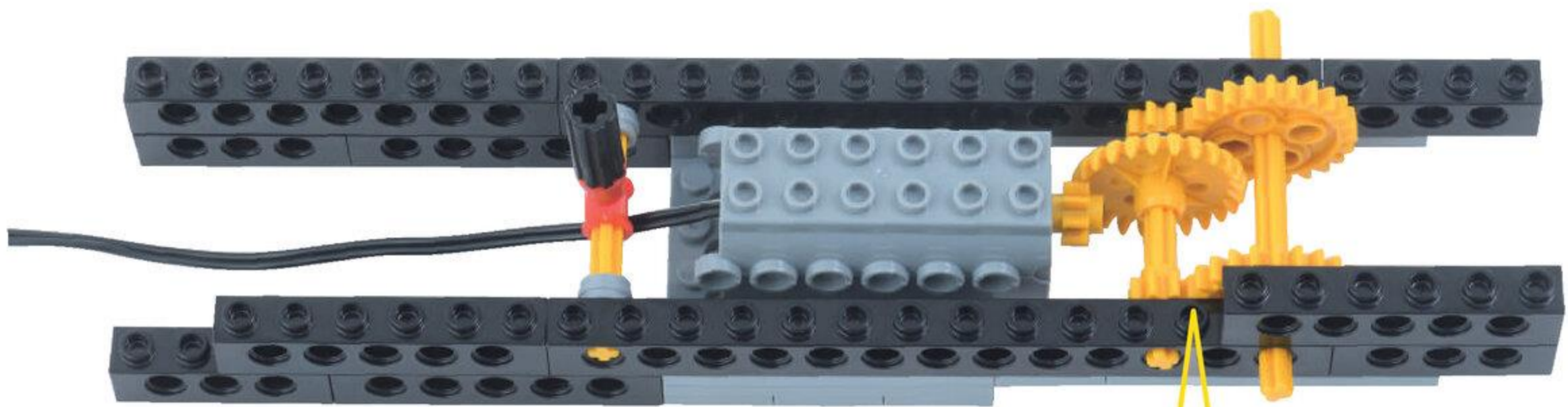
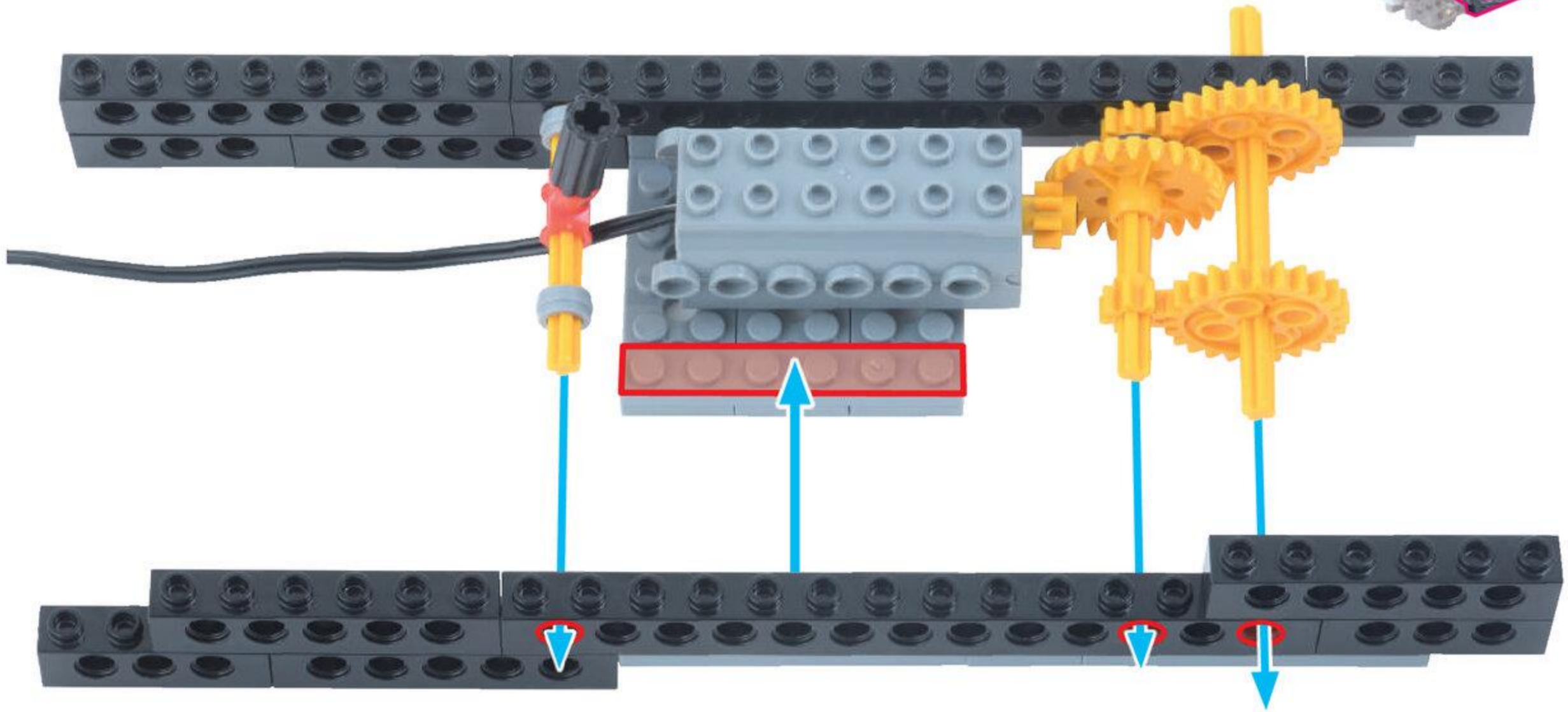
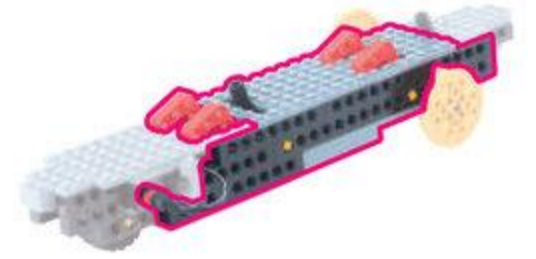

ギアが かみあっているか  
たしかめよう

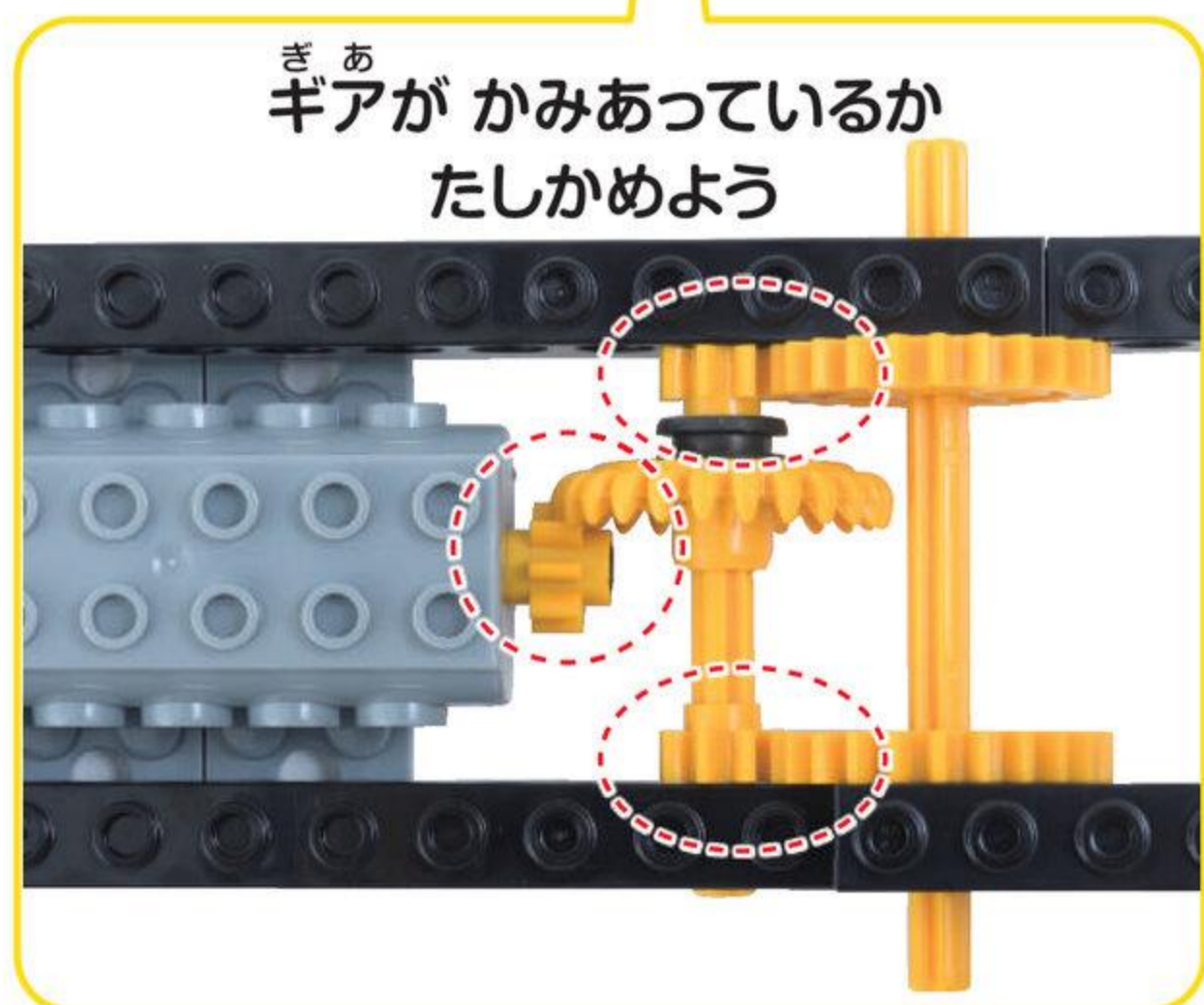



びいむじゅうよんほち  
 ビーム 14 ポチ 2こ



へぐえす  
 ペグ S 2こ



えろつど  
 L ロッド 2こ

13

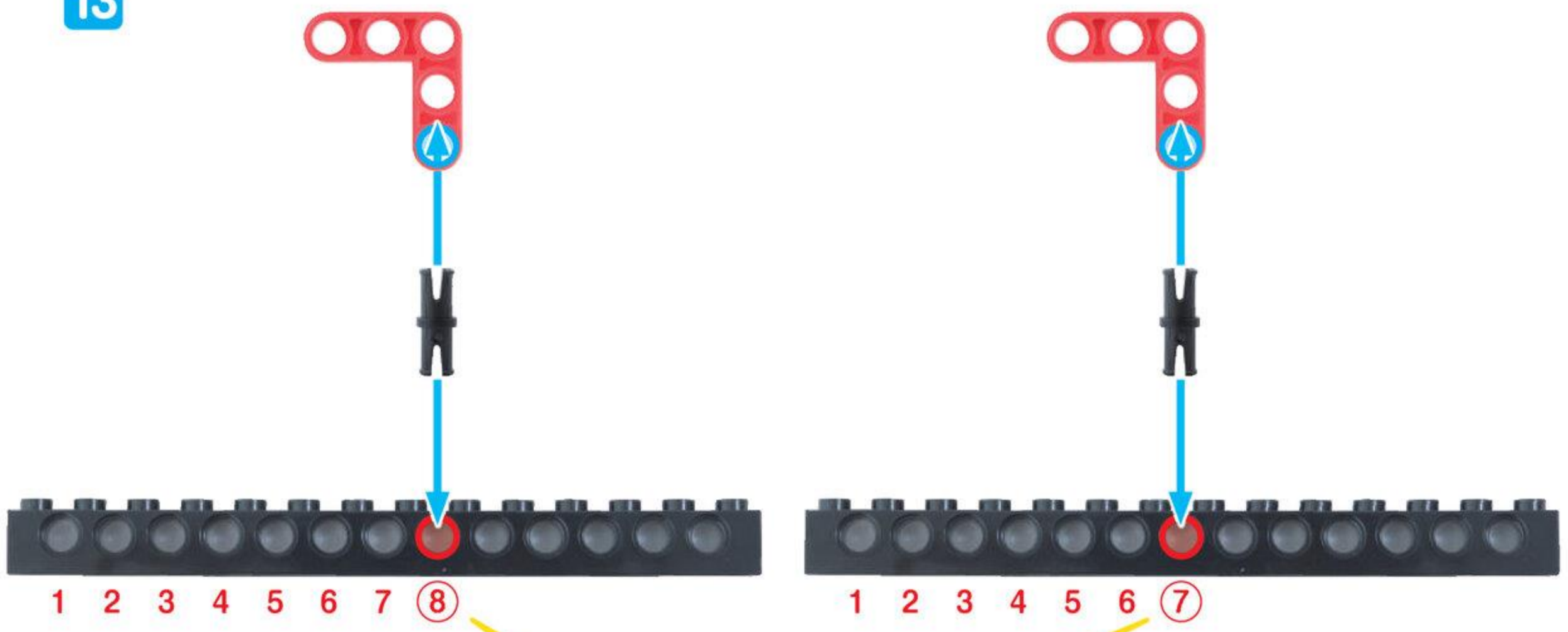

あなた  
 さしこむ アナのちがいに  
 ちゅういしよう



14

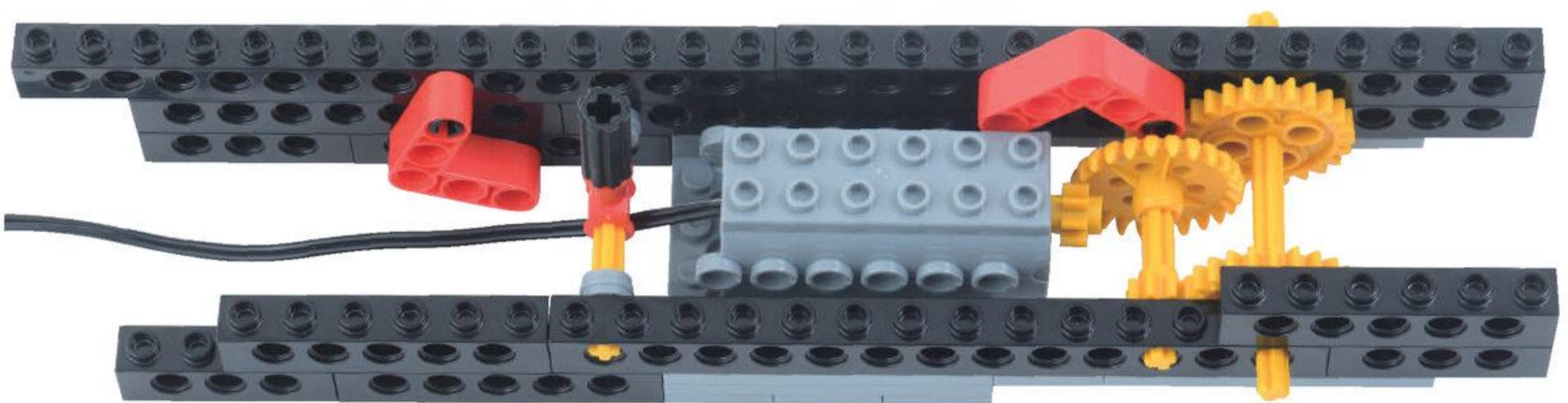
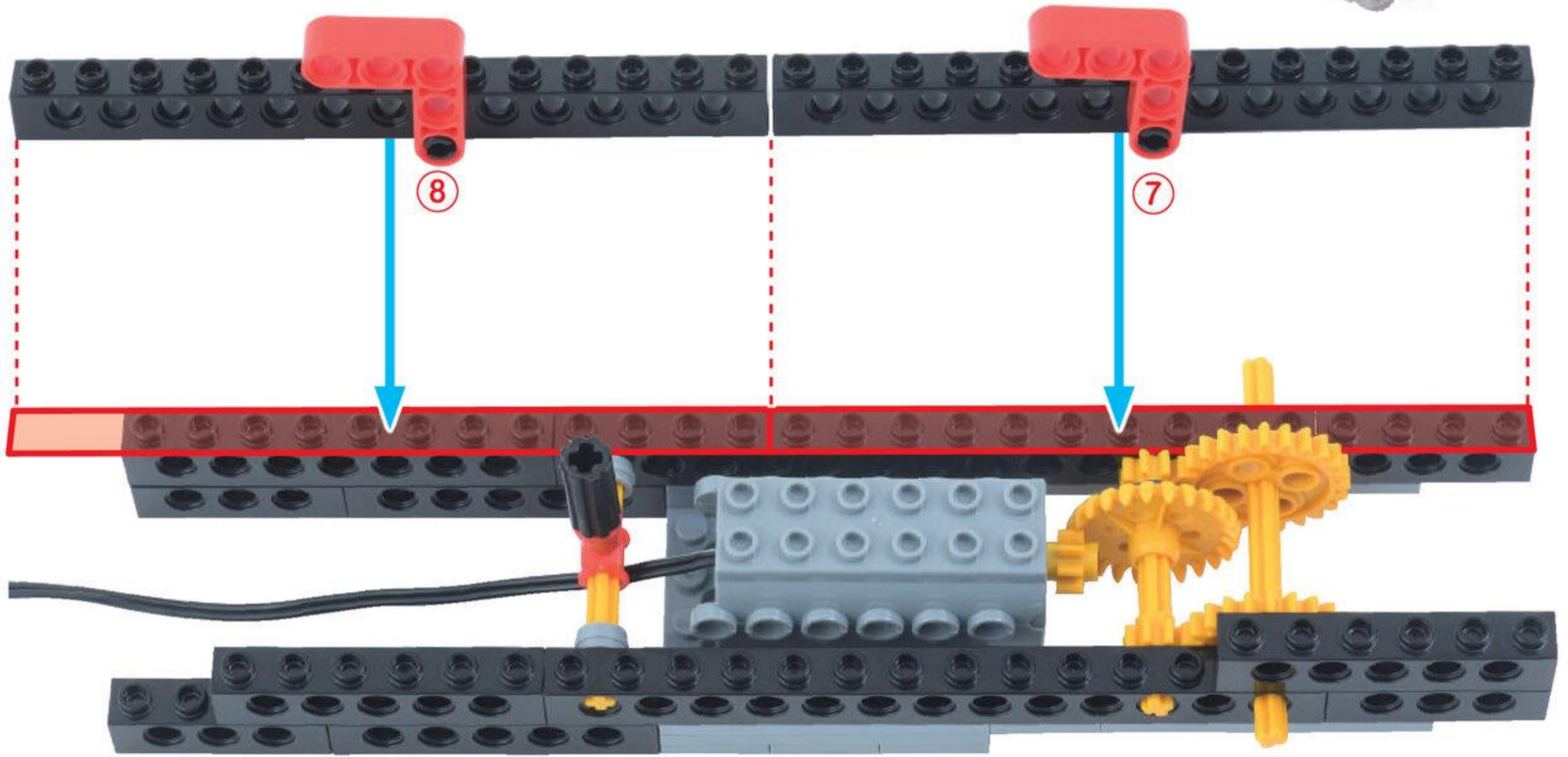
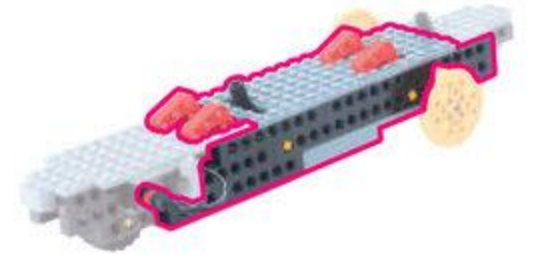

びいむはちぼち  
ビーム8ポチ 2こ



pegu S 2こ



erurodd  
Lロッド 2こ

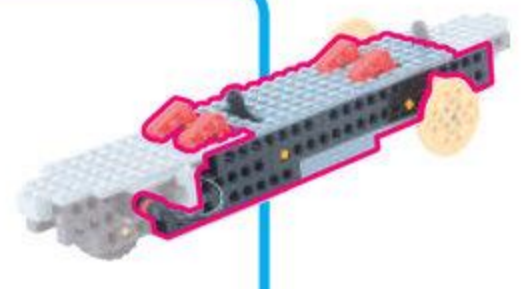

15

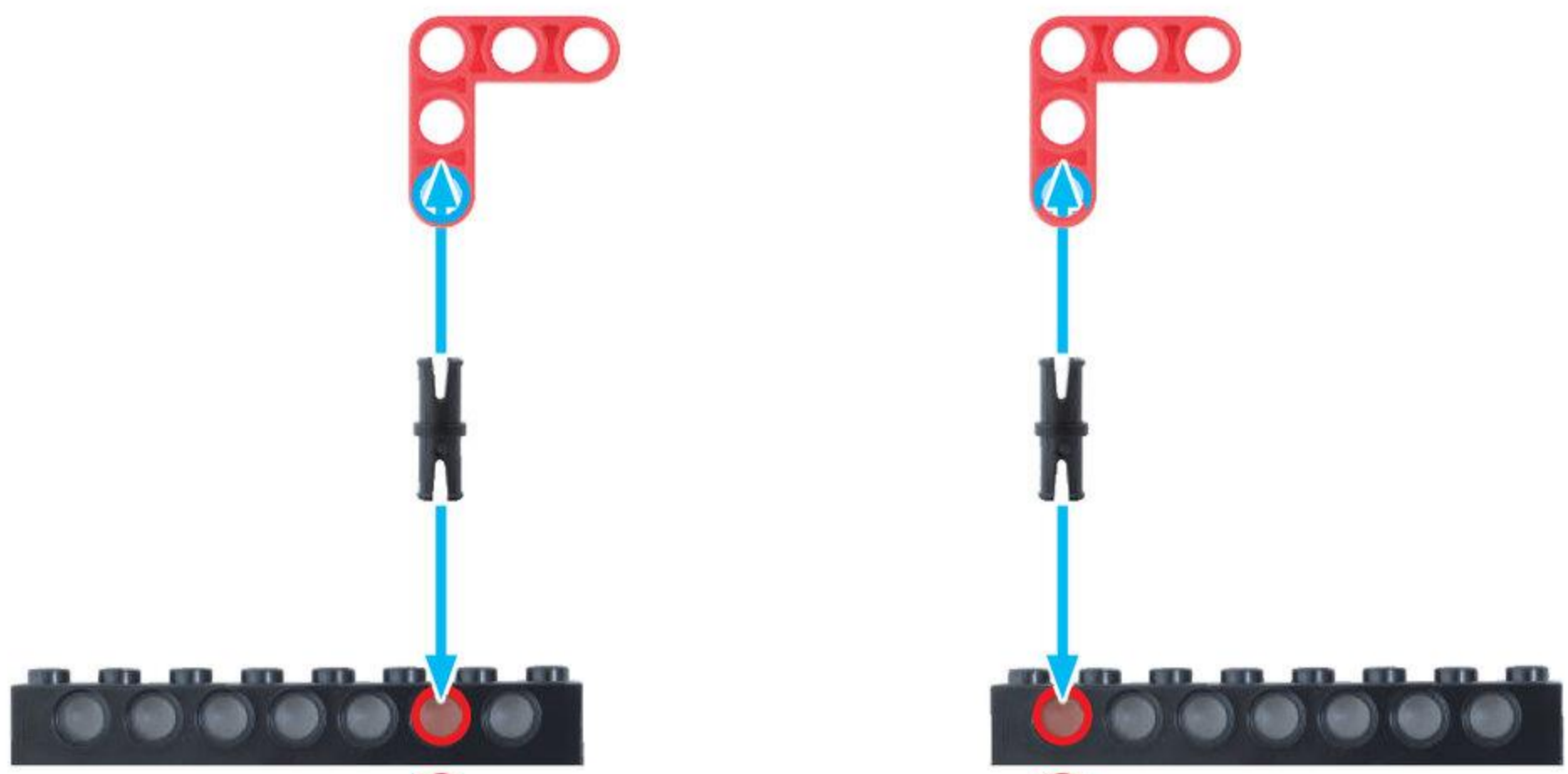

あなた  
さしこむ アナの ちがいに  
ちゅうい しよう

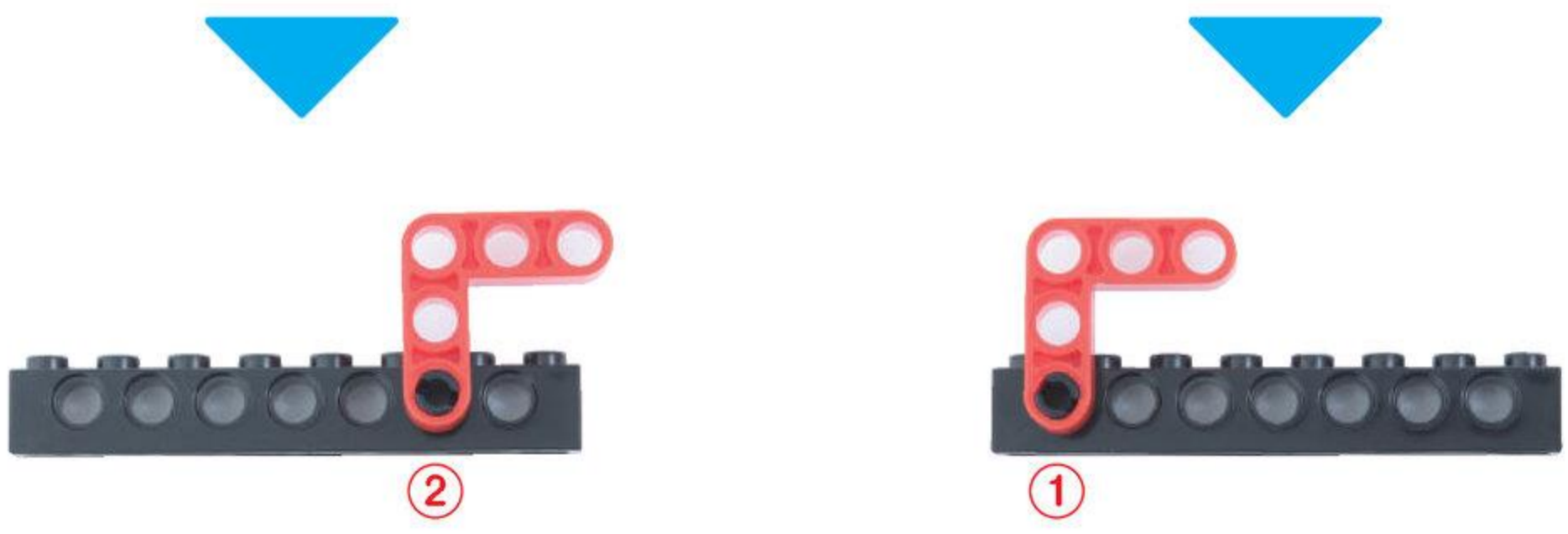

16

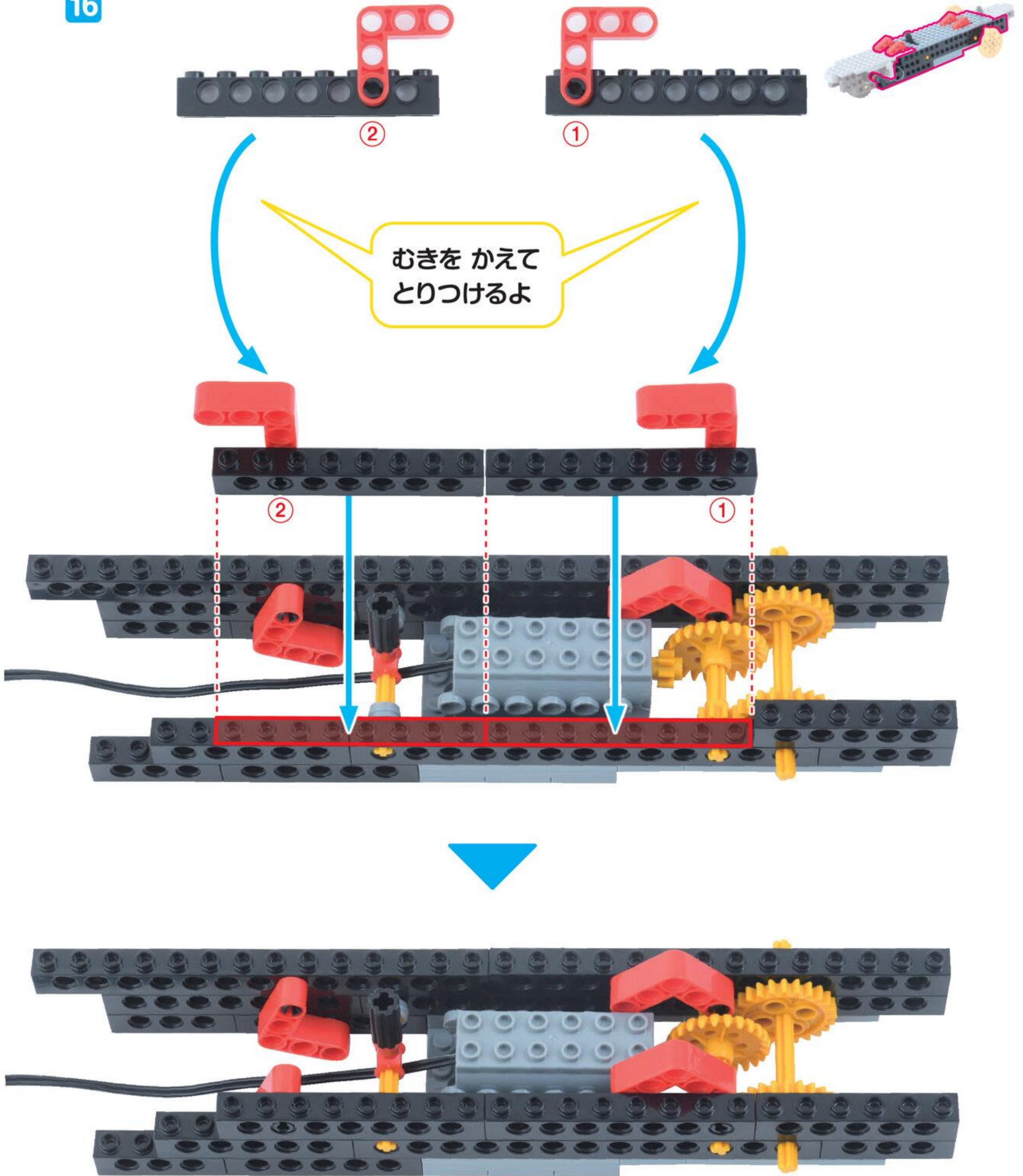

えろっど  
L ロッドは だい2かいで  
こどもとおとなの <sup>ひざ</sup>ヒザになるよ

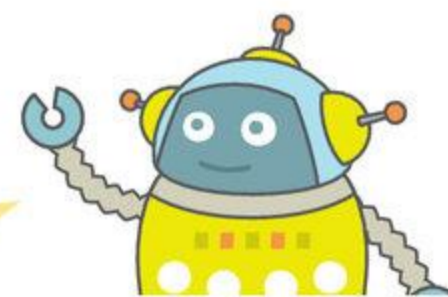

ふとぶれえとはちほち  
太プレート 8 ポチ 1 こ



17

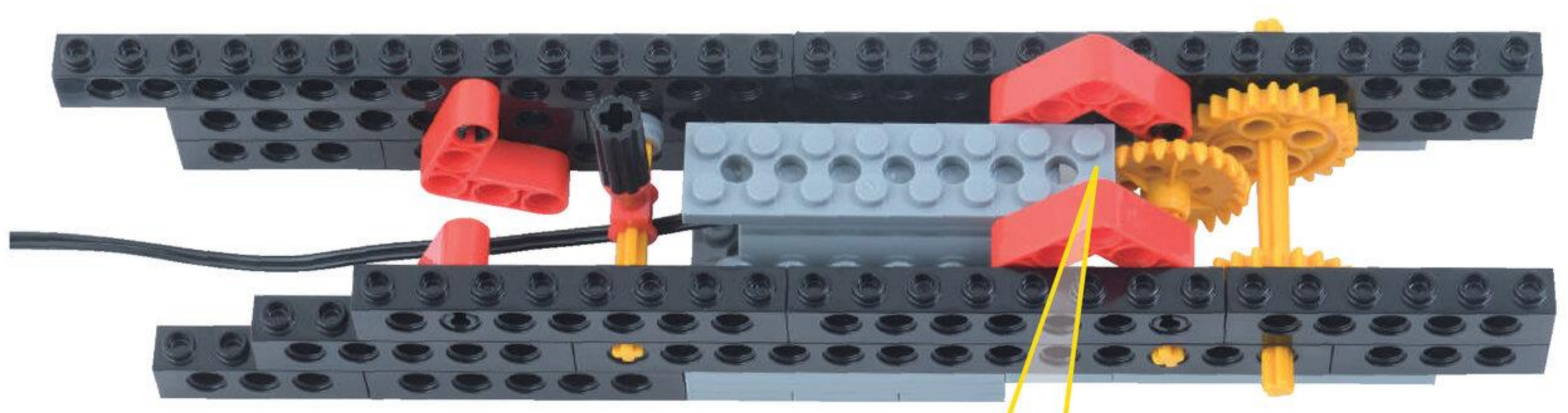
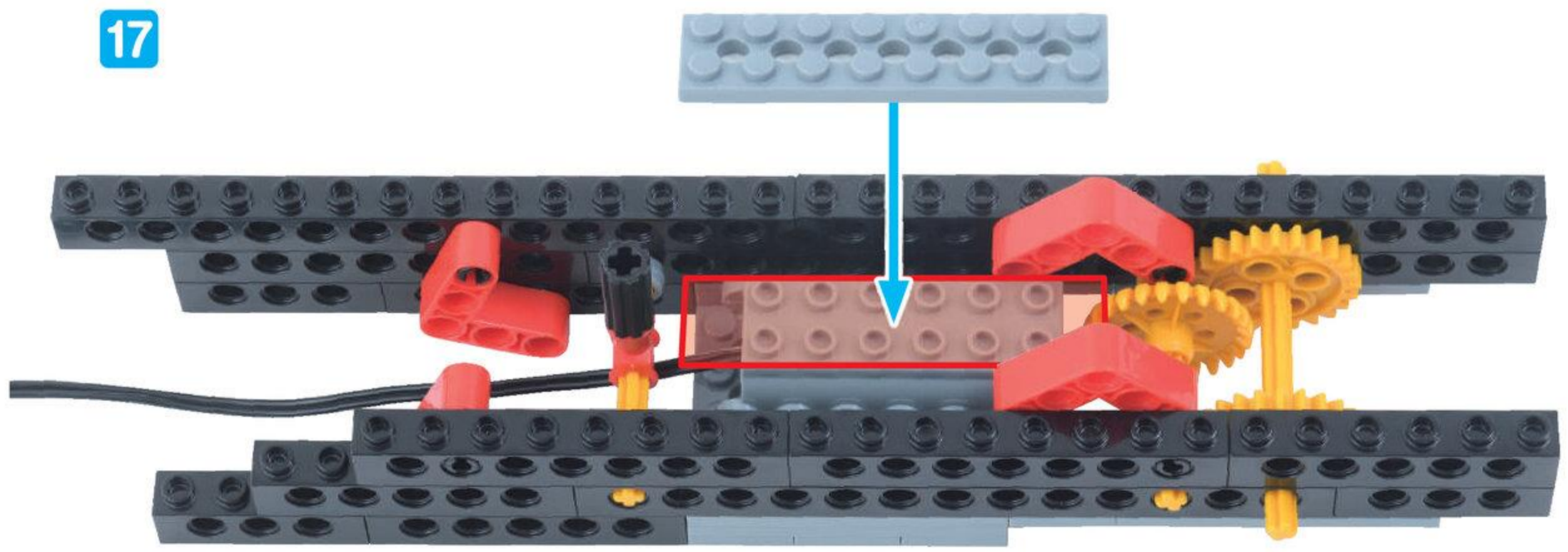

ほち  
1 ポチぶん はみでるよ



ほち  
1 ポチぶん

ふとぶれえとゆんぼち  
太プレート4ポチ 1こ



ぶれえとる  
プレートL 1こ

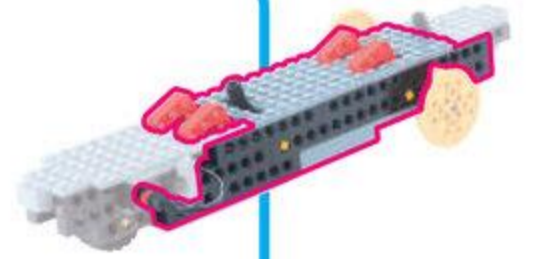
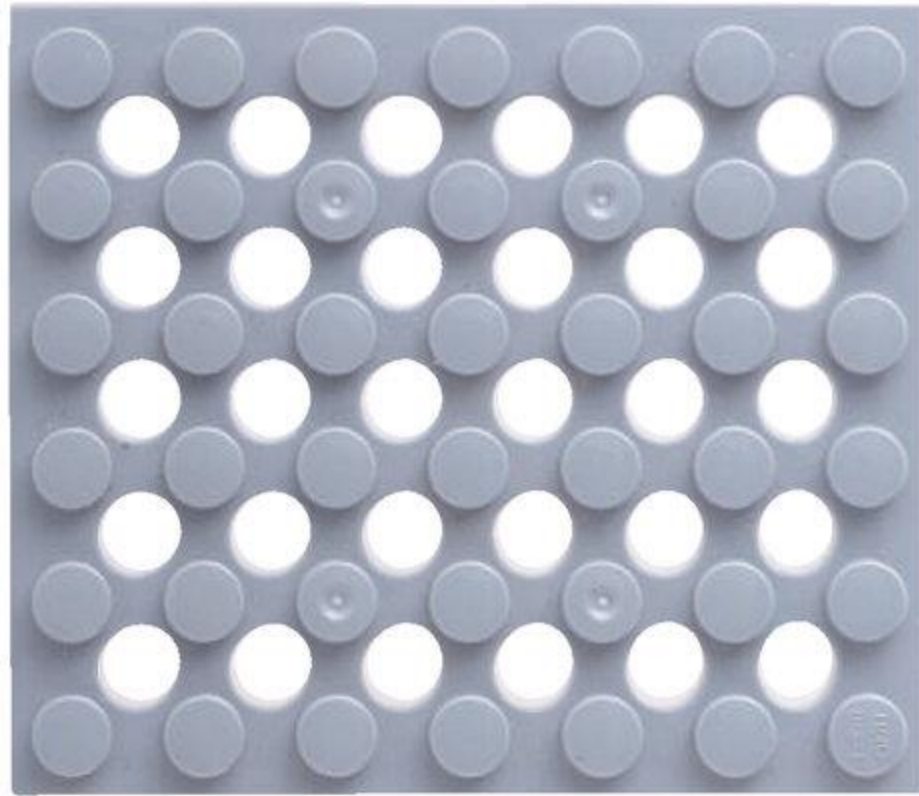

18

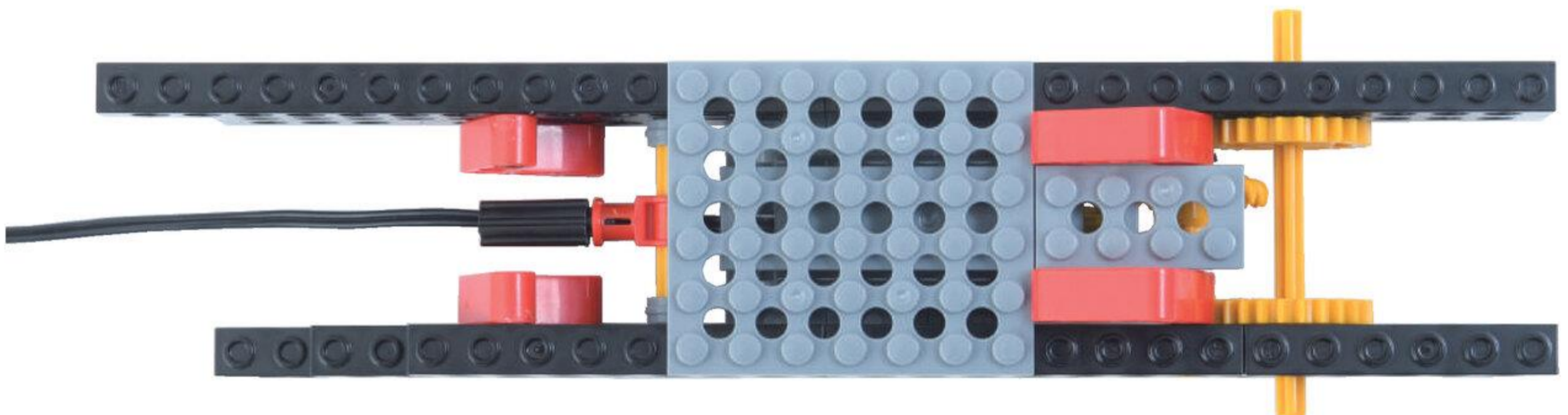
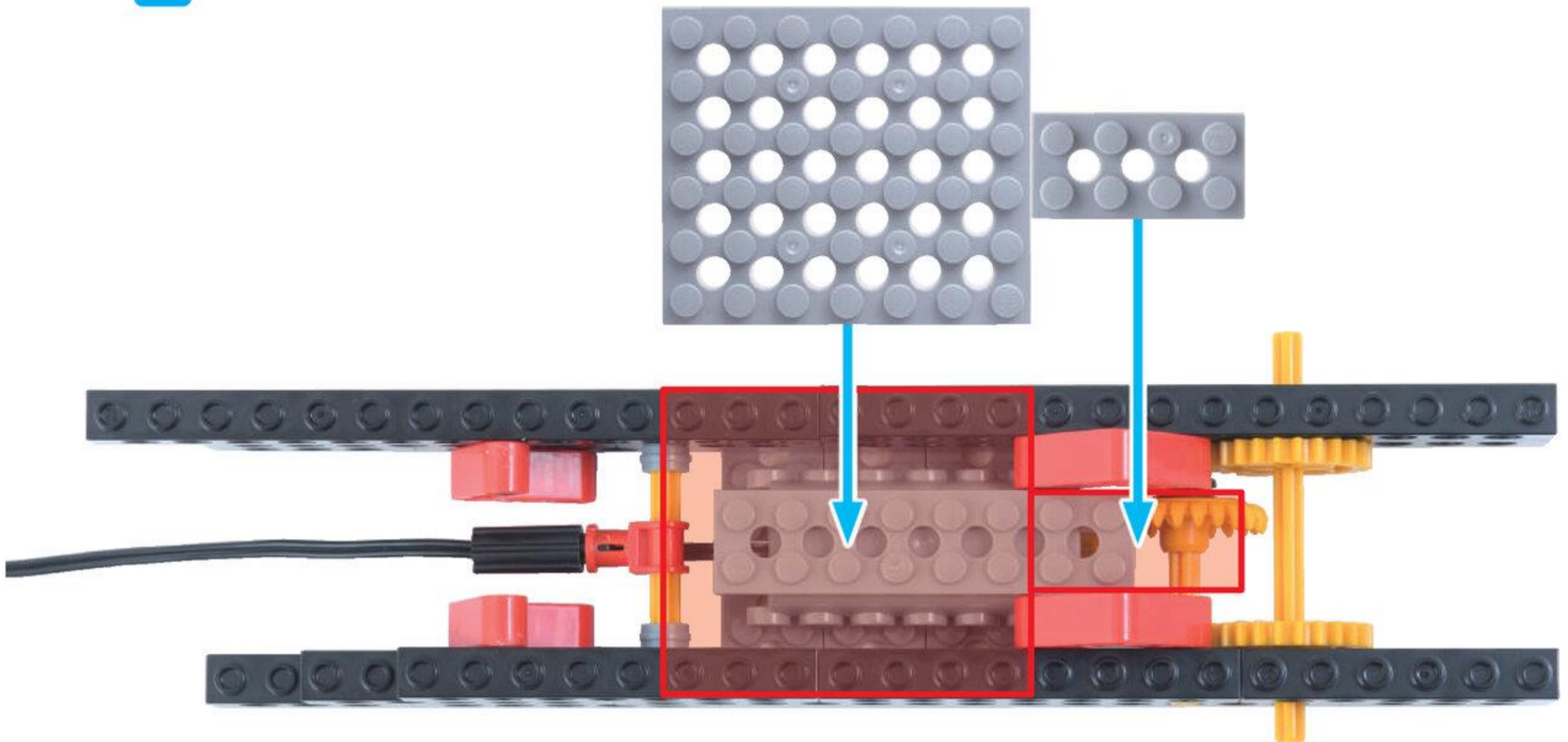



ほそぶれえとろくぼち  
細プレート6ポチ 1こ



ほそぶれえとゆぼち  
細プレート4ポチ 2こ



ふとぶれえとろくぼち  
太プレート6ポチ 1こ



19

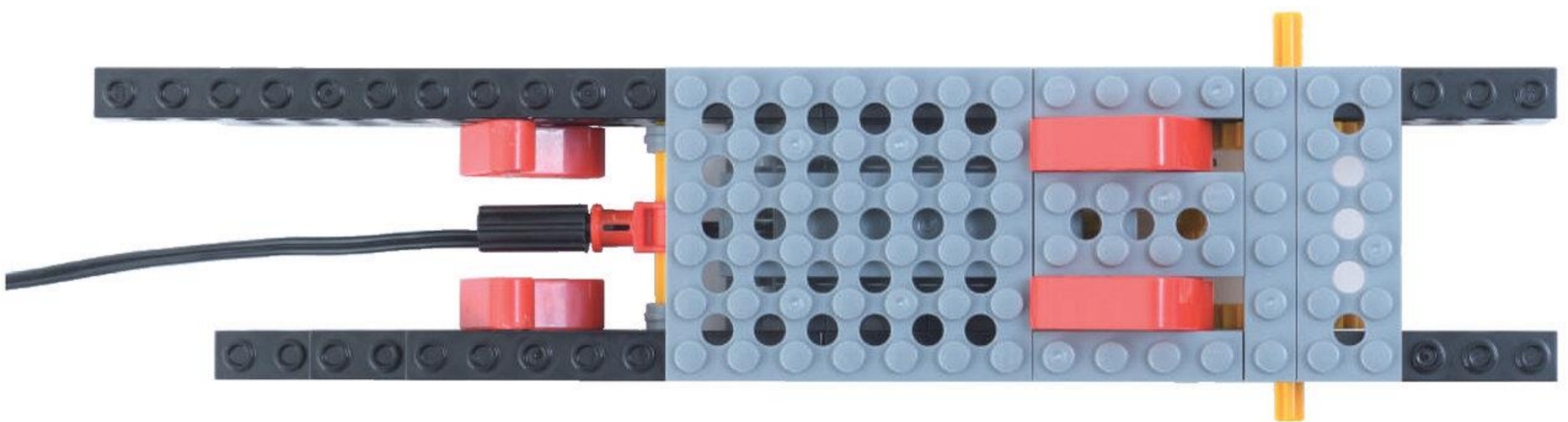
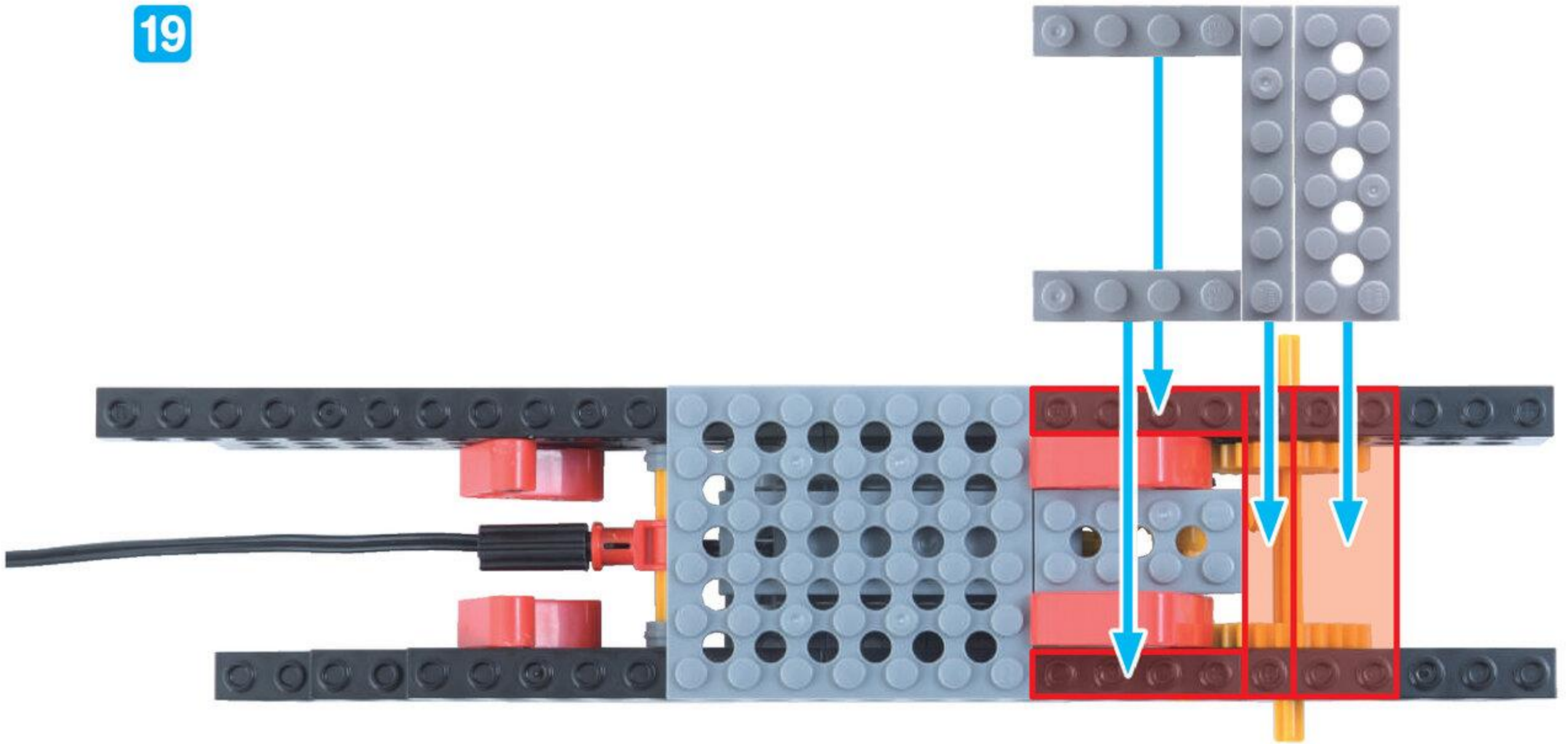

ほそぶれえといち ぼち  
細プレート 1 ポチ **2** こ



ほそぶれえとろく ぼち  
細プレート 6 ポチ **1** こ



20

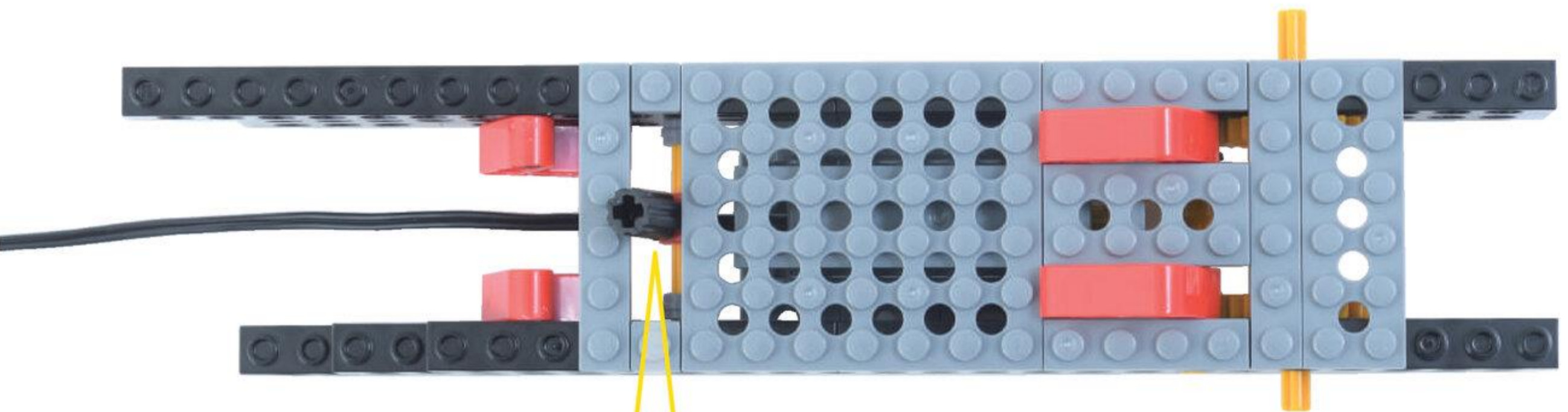
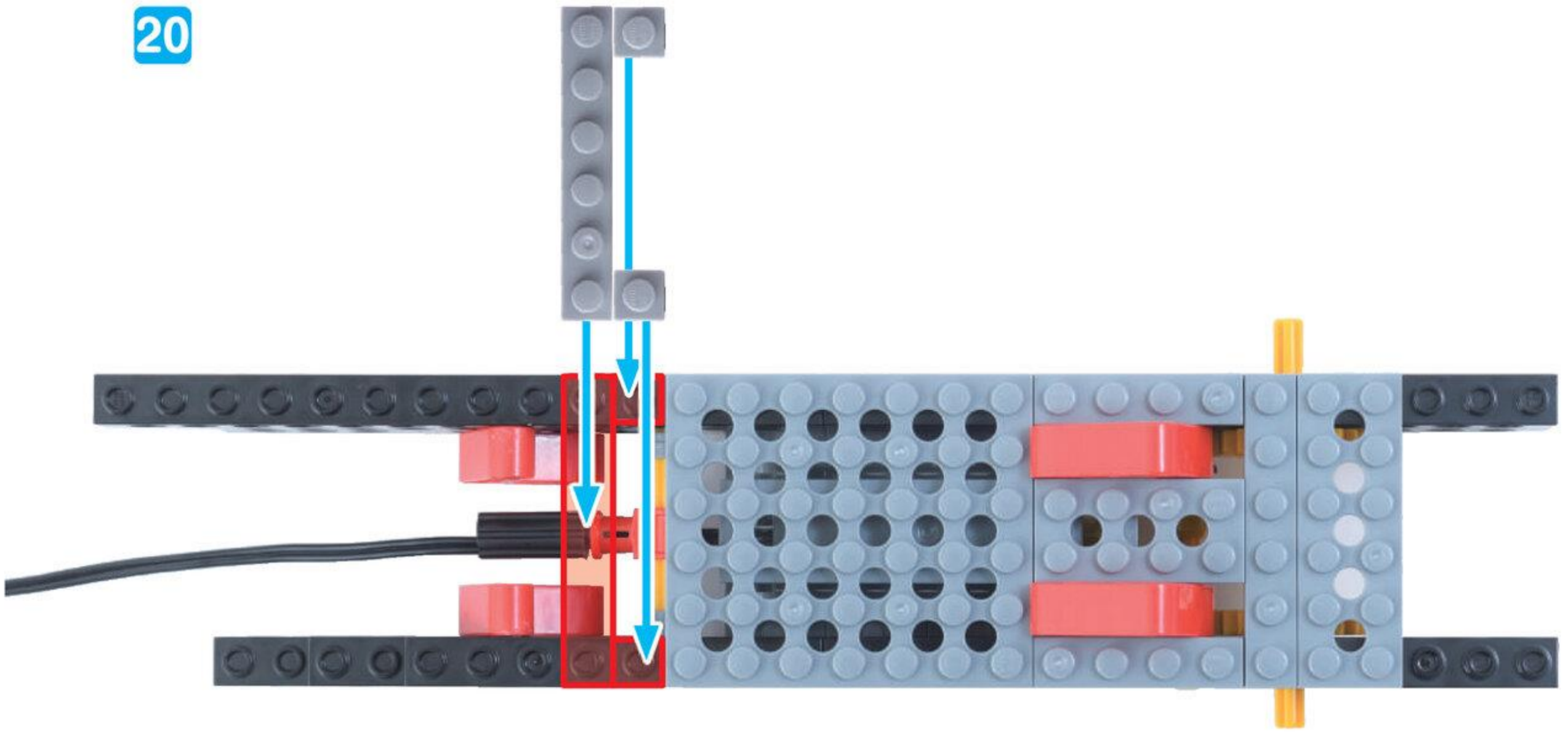

しゃふとじょいんと  
シャフトジョイントの むきに ちゅうい



ふれえとろ  
プレートL 1こ

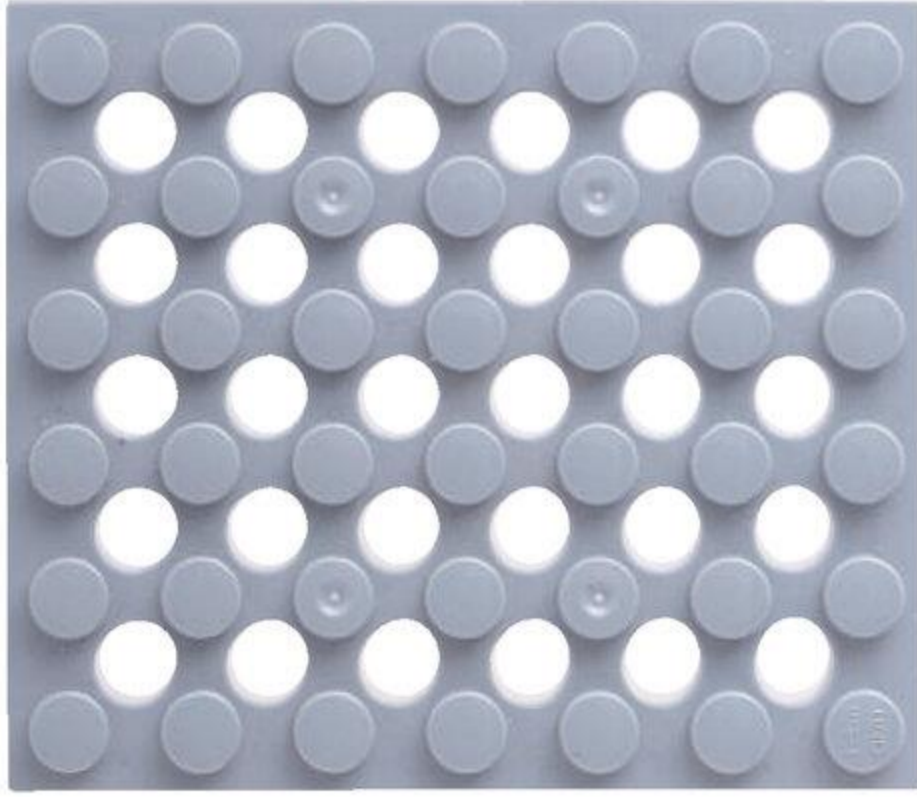

ふとふれえとろくほち  
太プレート6ポチ 1こ

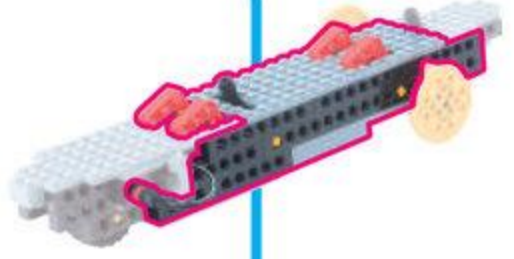

21

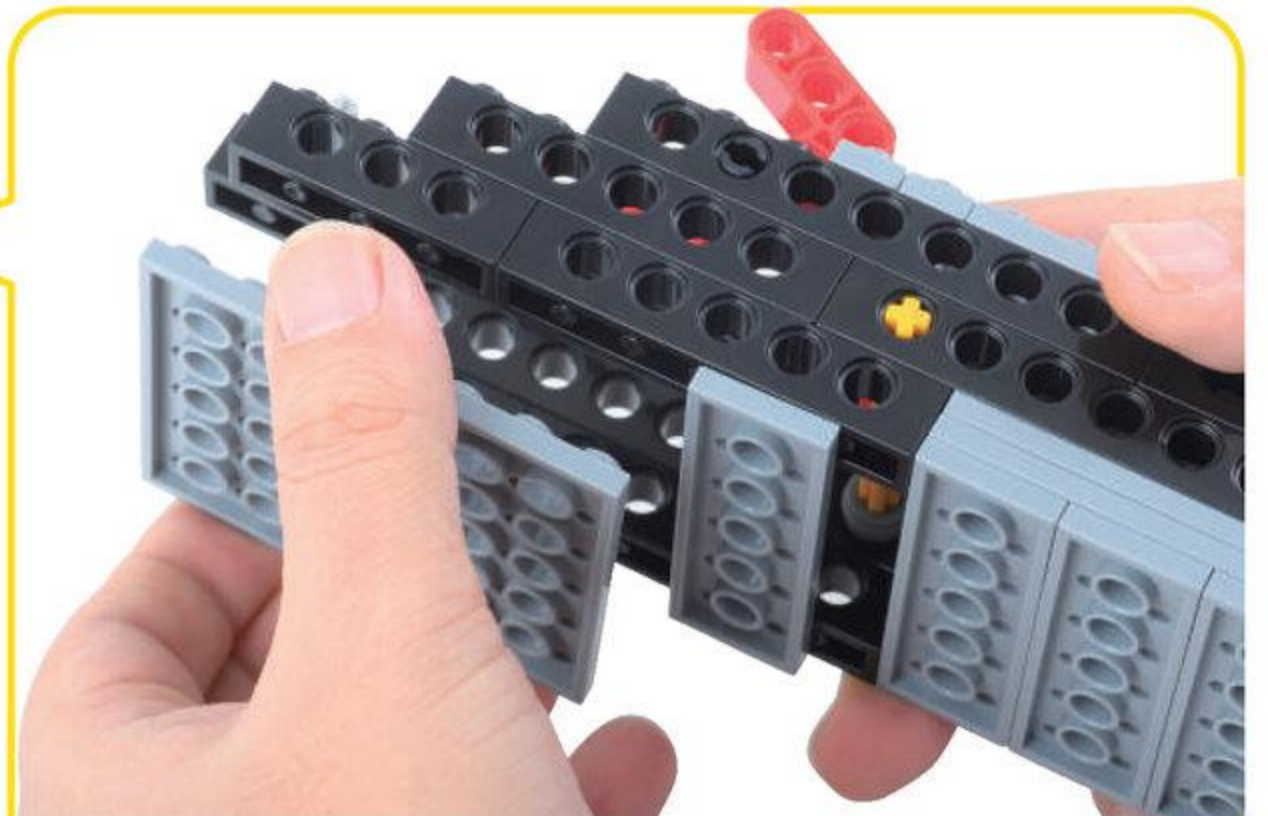
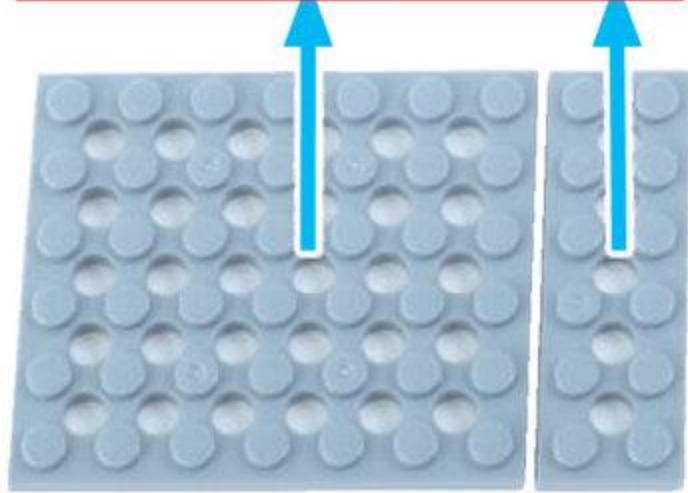
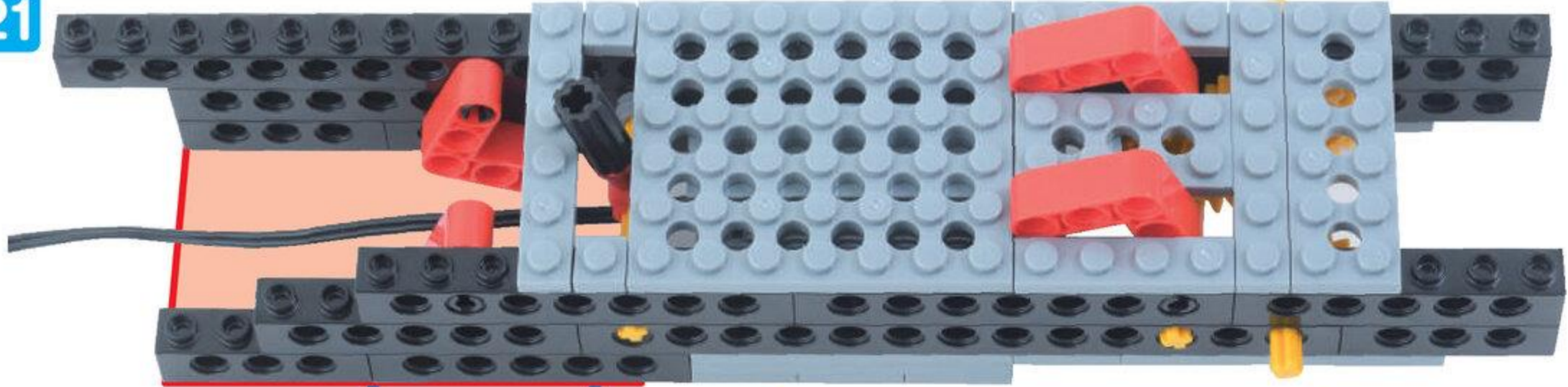

したから とりつけるよ

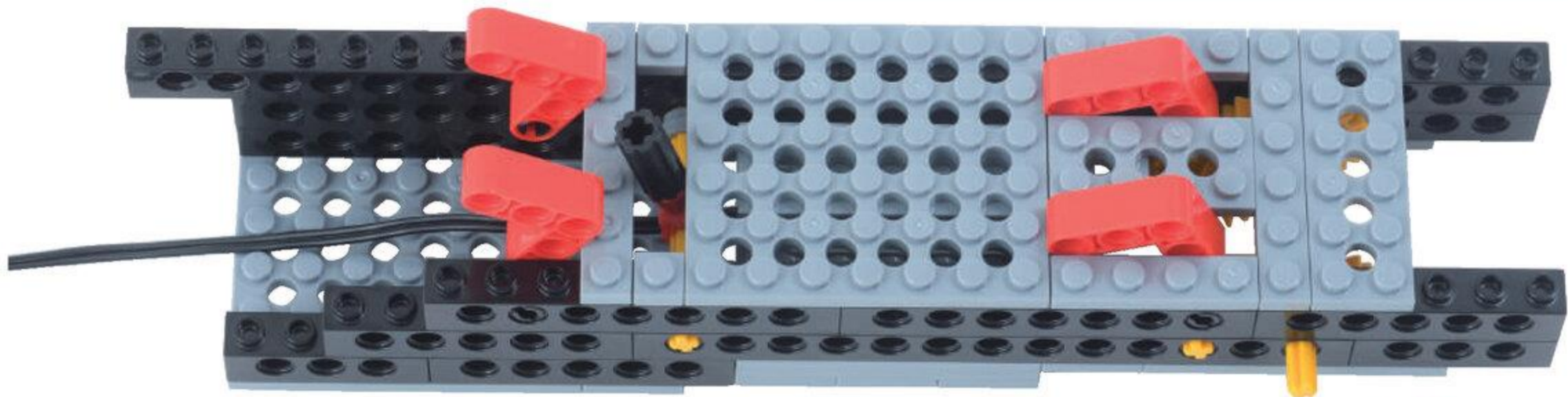

やったね!

ふね (まんなか) が  
かんせい



## 2 ふね (まえ)

めやす 15 ぶん

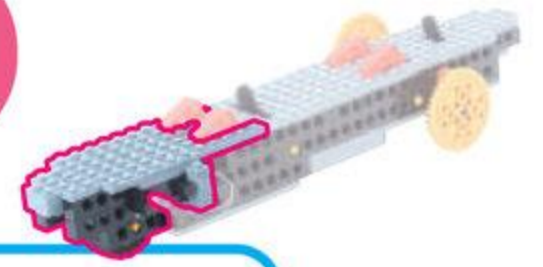

びいむよんぼち  
ビーム 4 ポチ **2**こ



びいむろくぼち  
ビーム 6 ポチ **1**こ



1

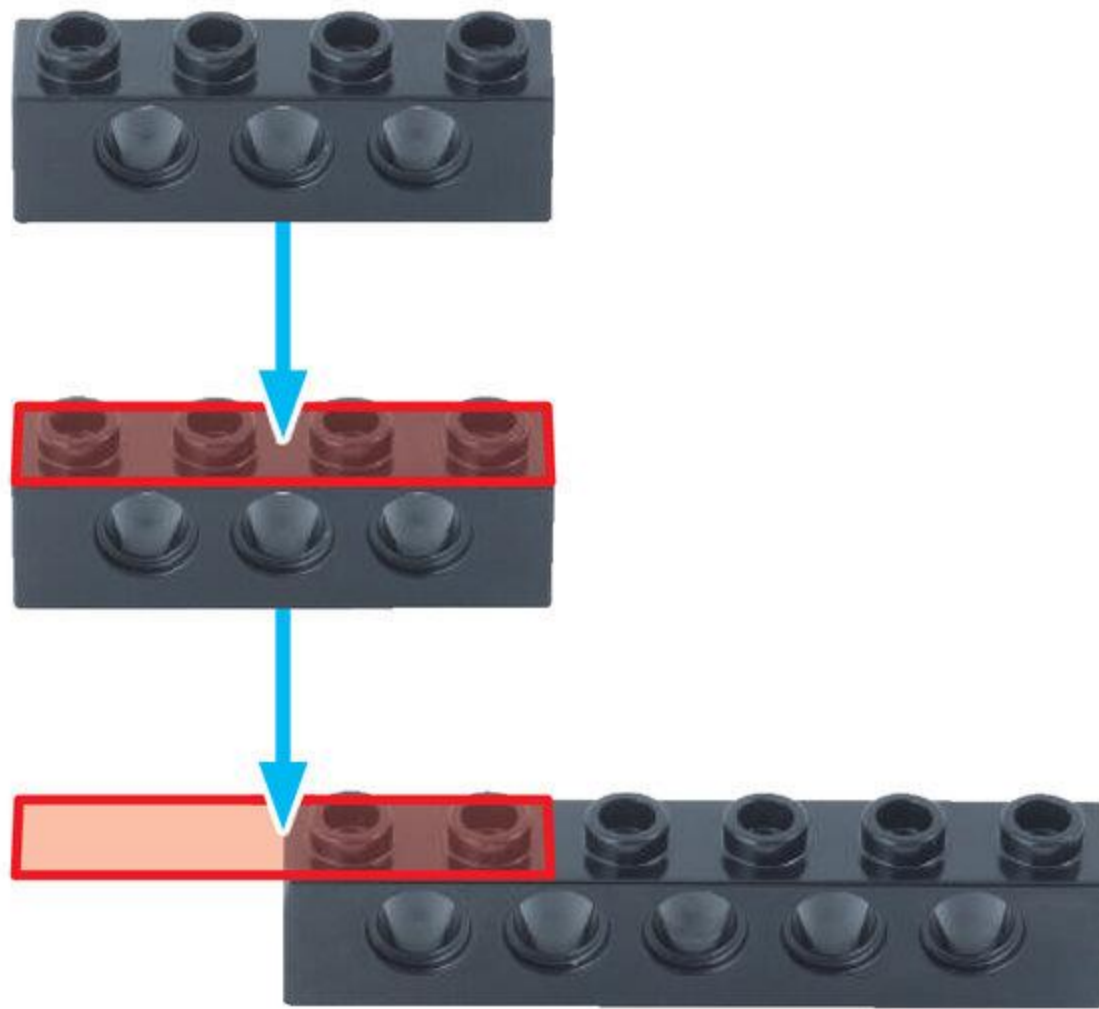

ほそぶれえとにほち  
細プレート2ポチ **2**こ



ほそぶれえとよんほち  
細プレート4ポチ **1**こ

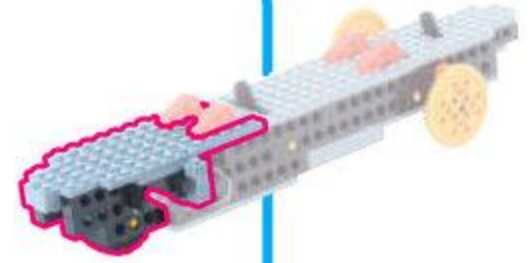

2

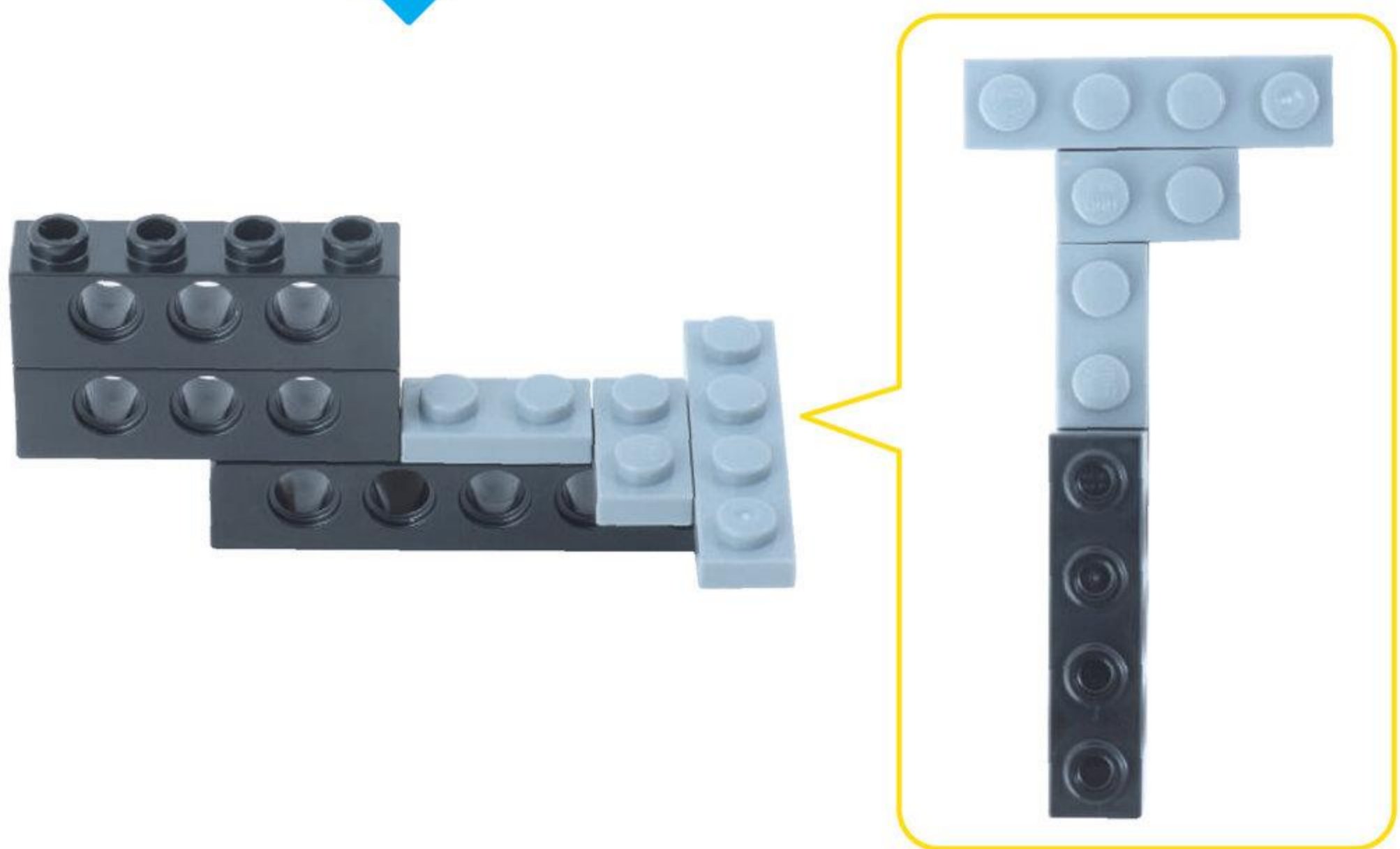
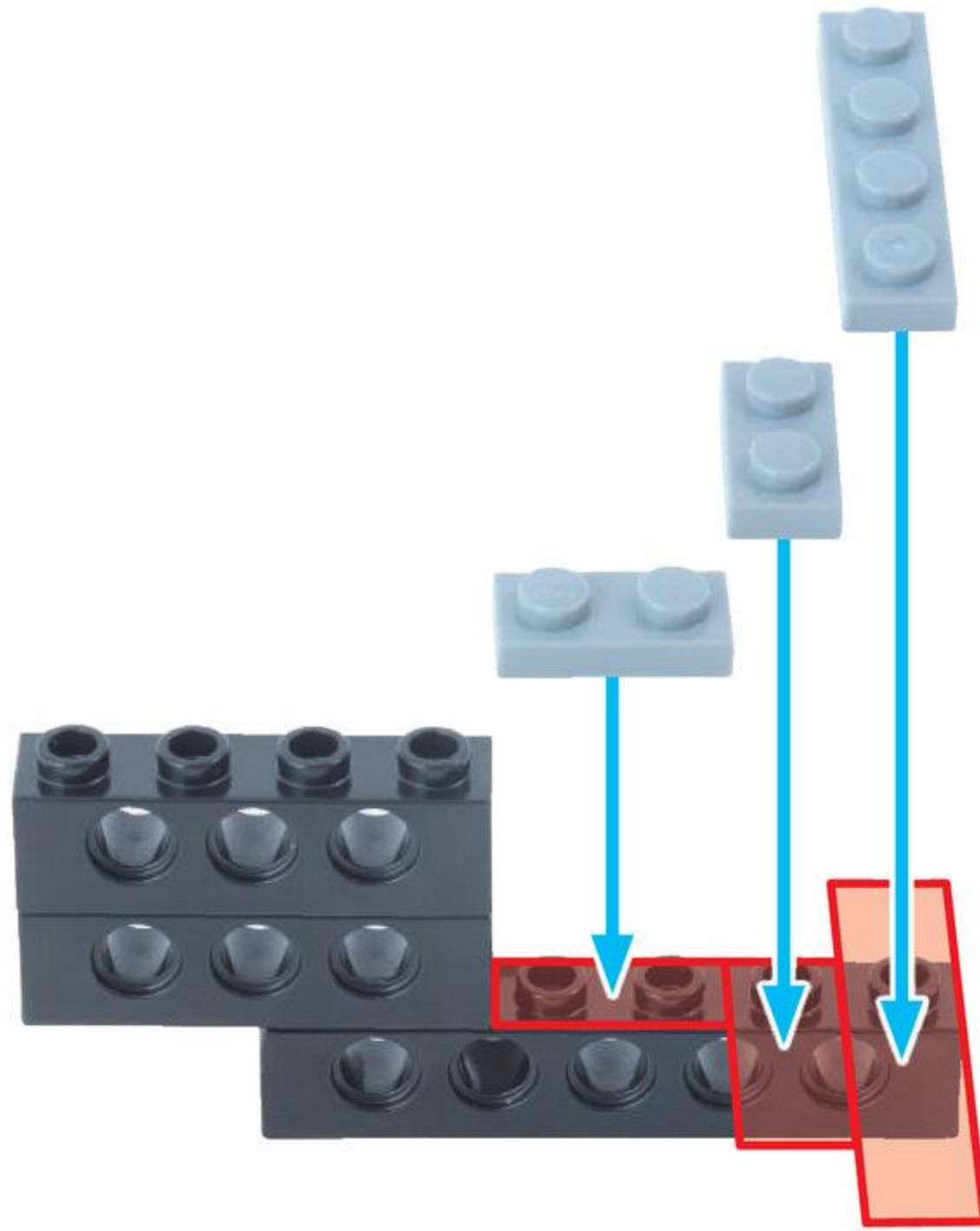

ばってりいぼっくす すらいどすいっち 1こ  
バッテリーボックス / スライドスイッチ 1こ

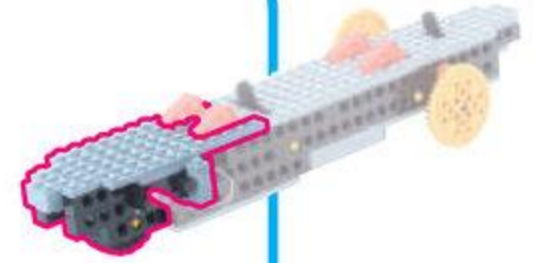

3

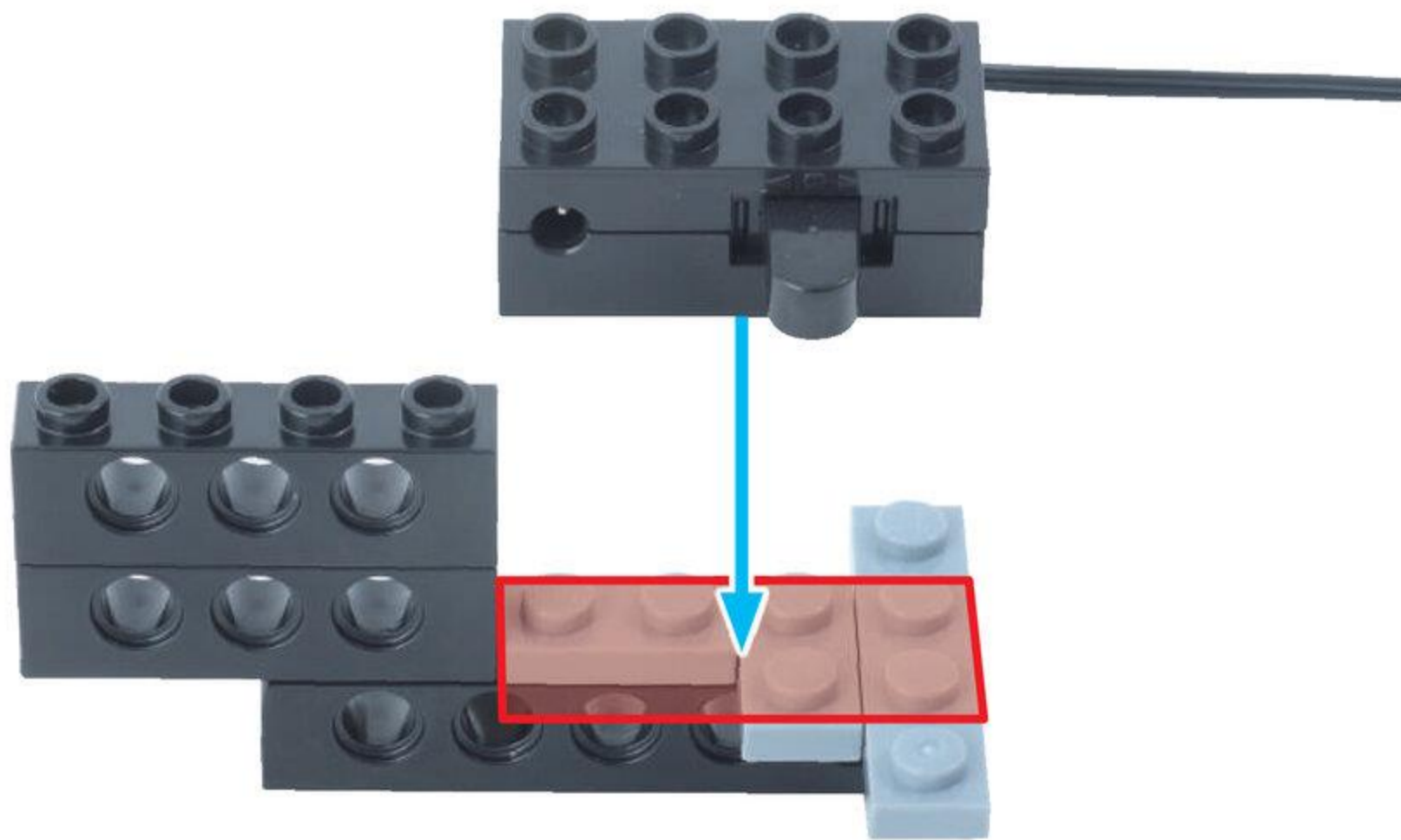

ほそぶれえといちぼち  
細プレート 1 ポチ 1こ



びいむいちぼち  
ビーム 1 ポチ 1こ

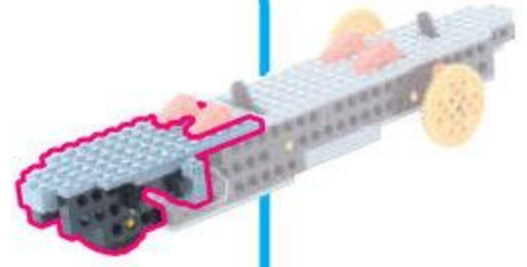

4

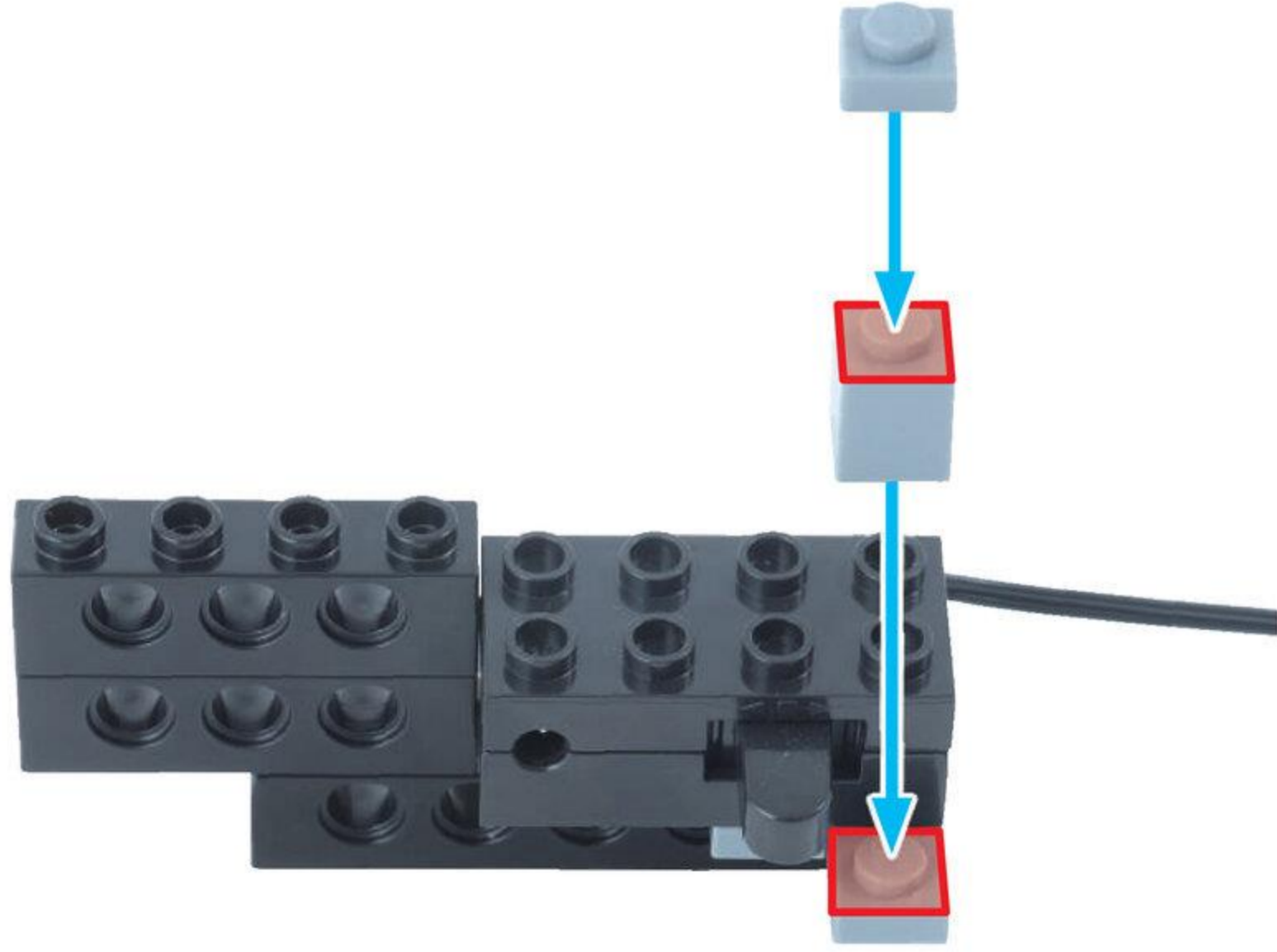

ほそぶれえとにほち  
細プレート2ポチ 4こ

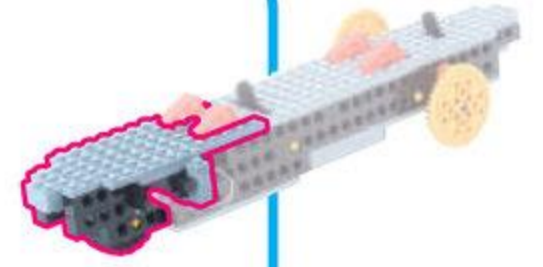

5

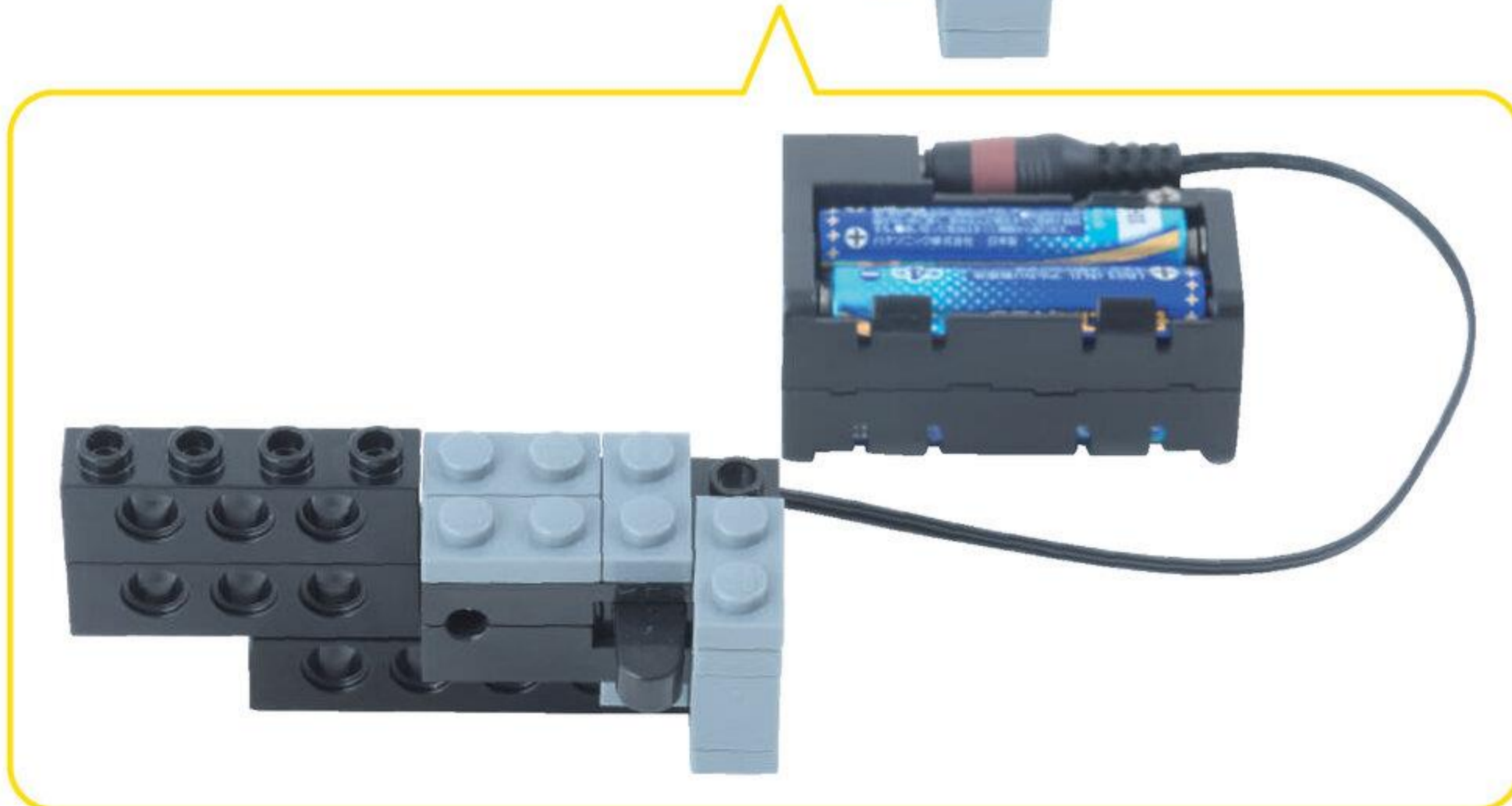
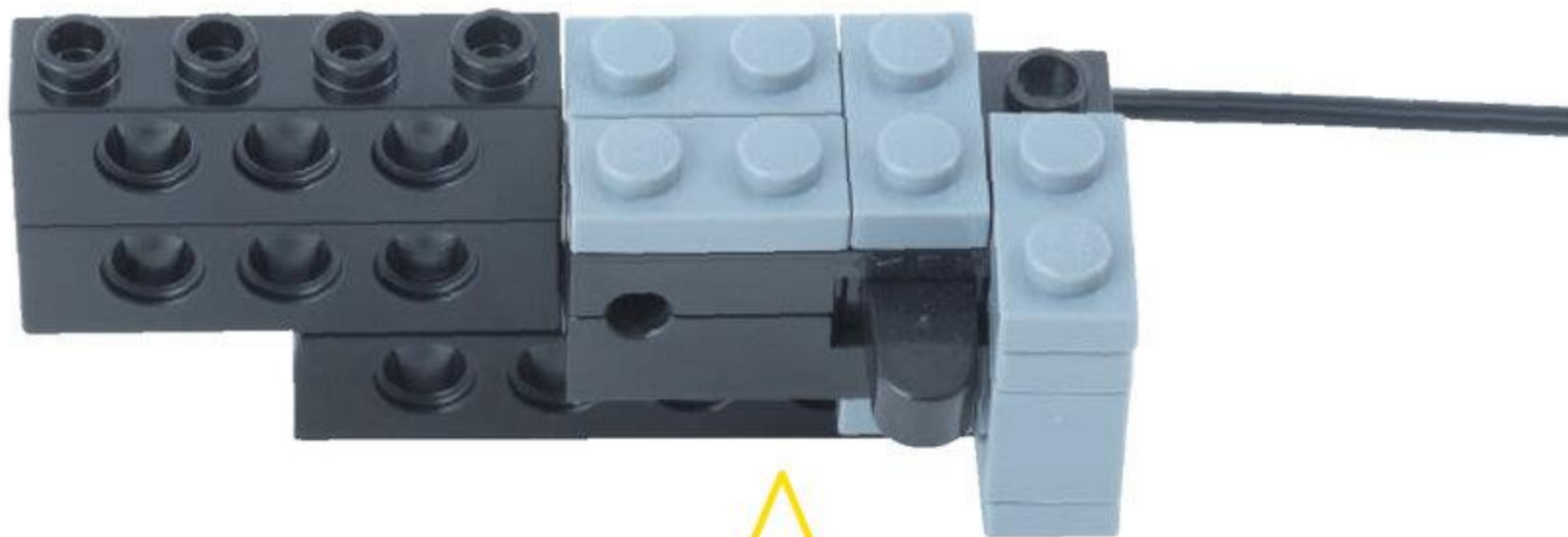
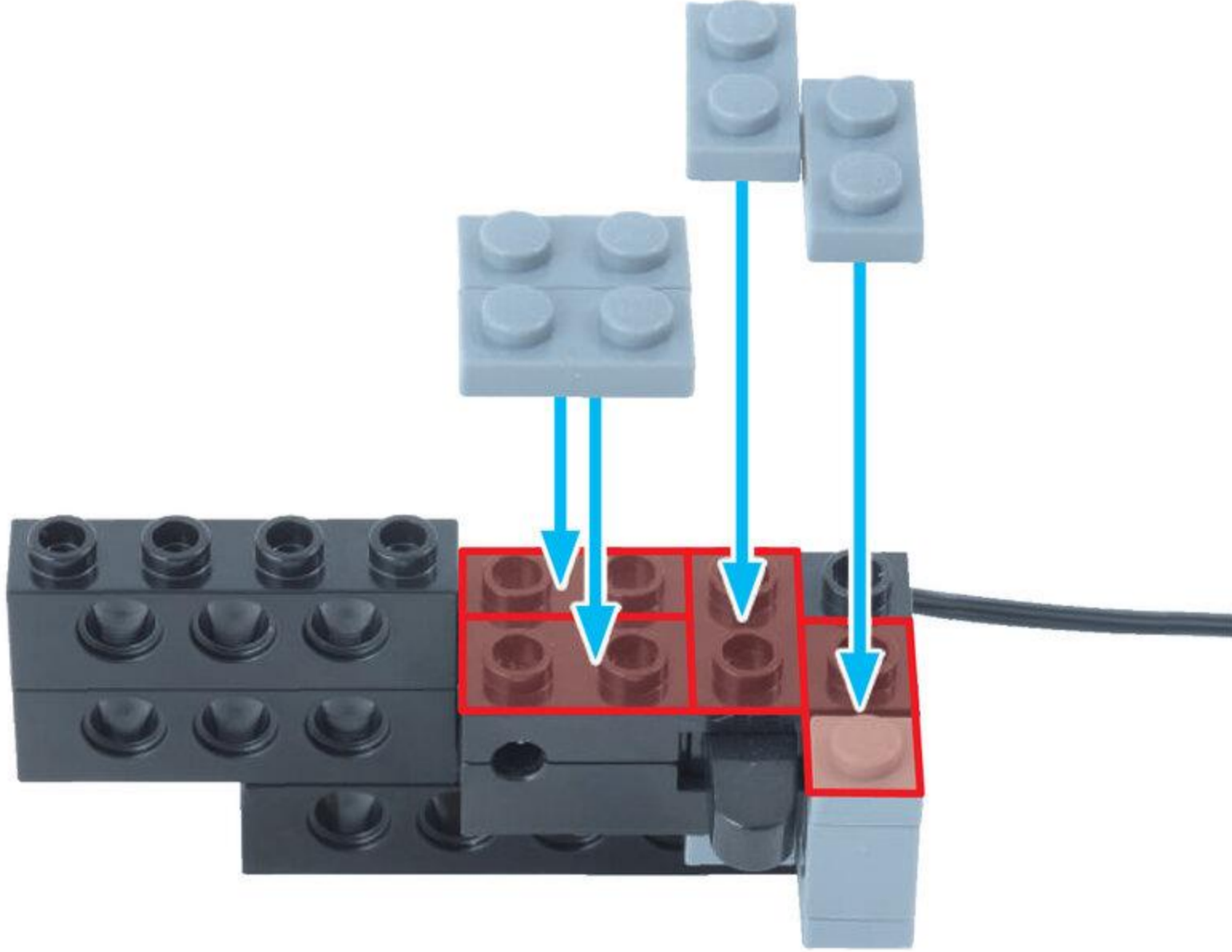



びいむはちほち  
ビーム 8 ポチ **2**こ

びいむろくほち  
ビーム 6 ポチ **1**こ

6

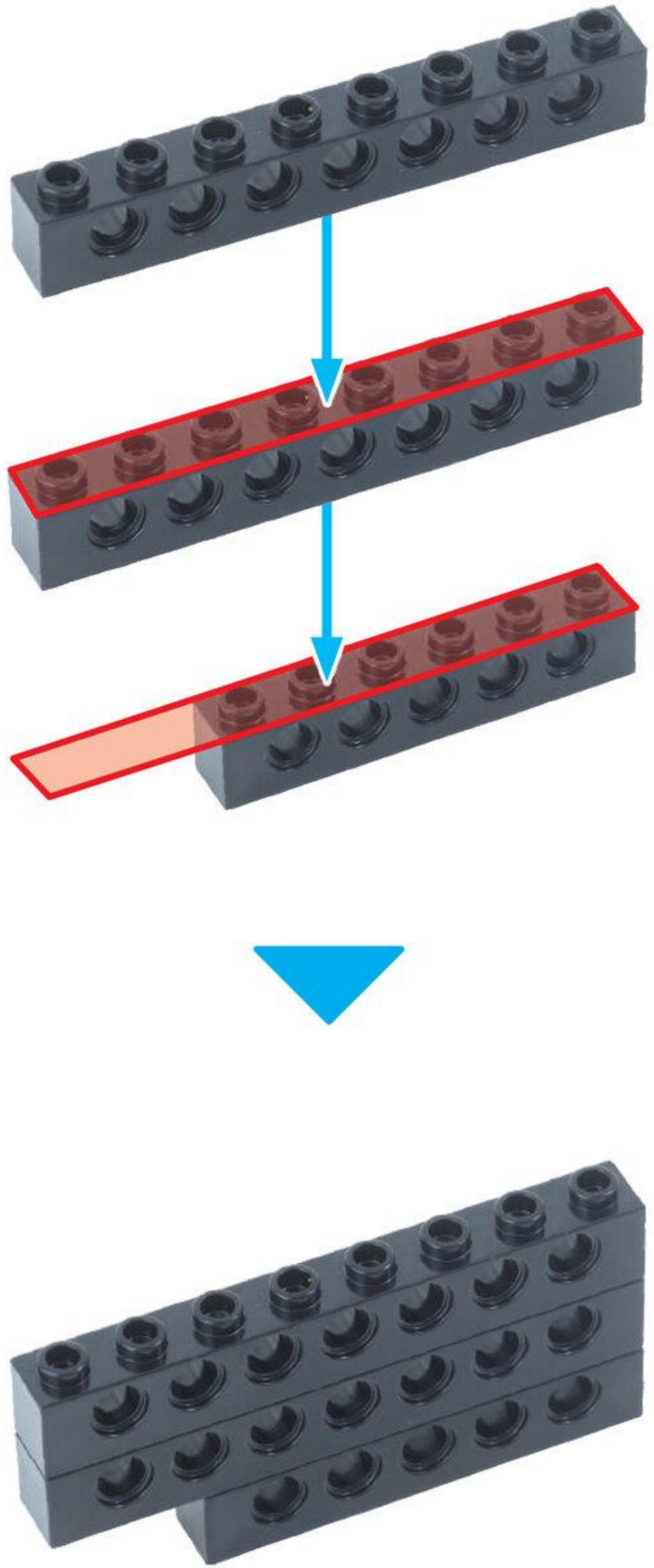

タイヤ S 1こ



シャフト 4ポチ 1こ



ながさに  
ちゅうい

ぶっしゅ 1こ



ピニオンギア 1こ

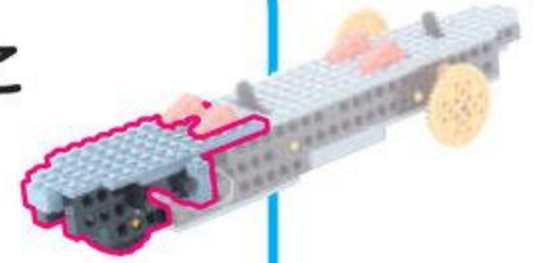
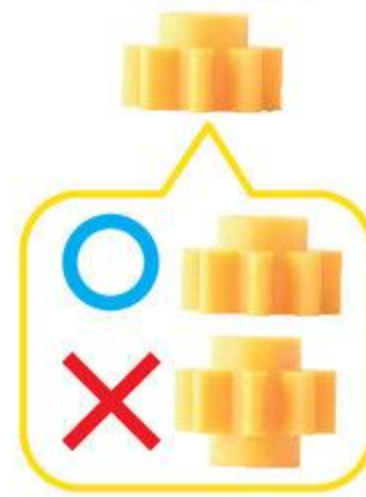

7

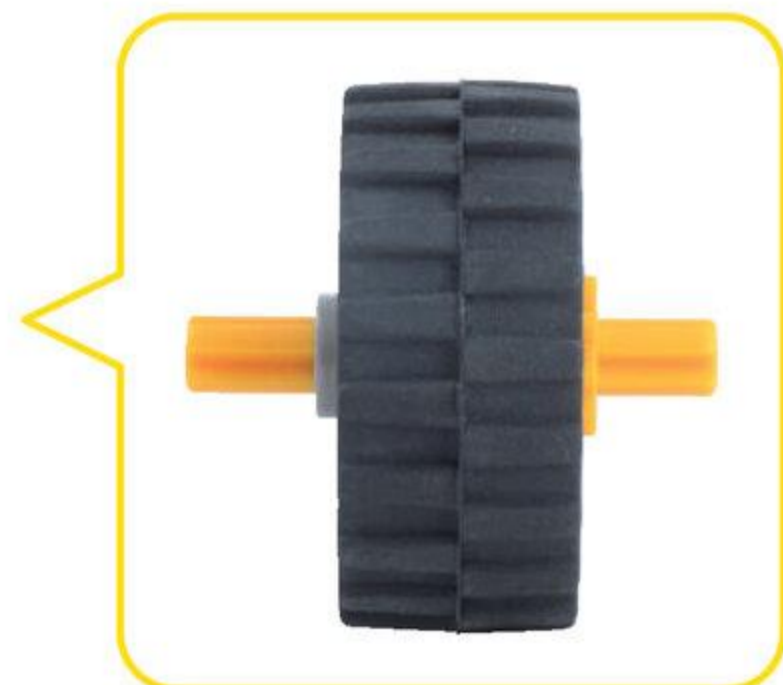
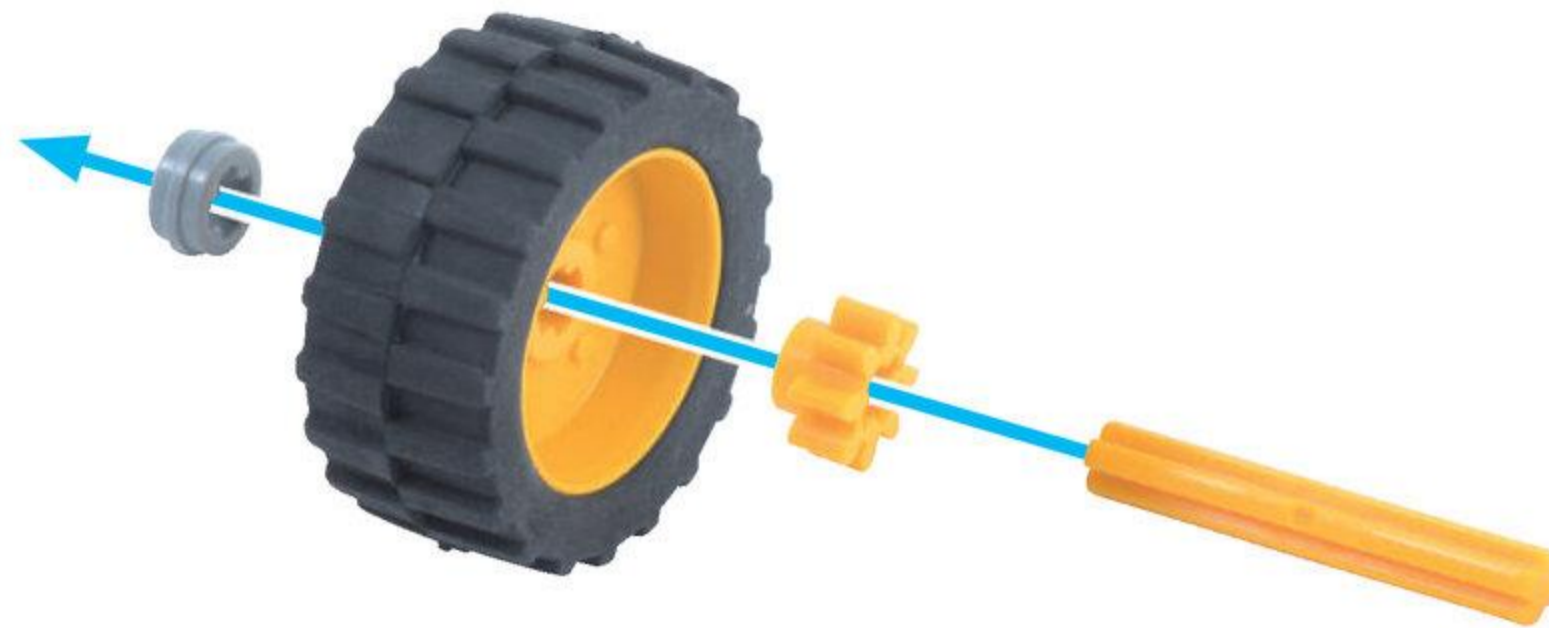

ふとぶれえとよんほち  
太プレート 4 ポチ **3** こ



ほそぶれえとにほち  
細プレート 2 ポチ **1** こ

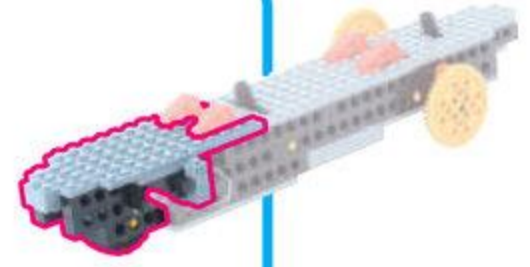

8

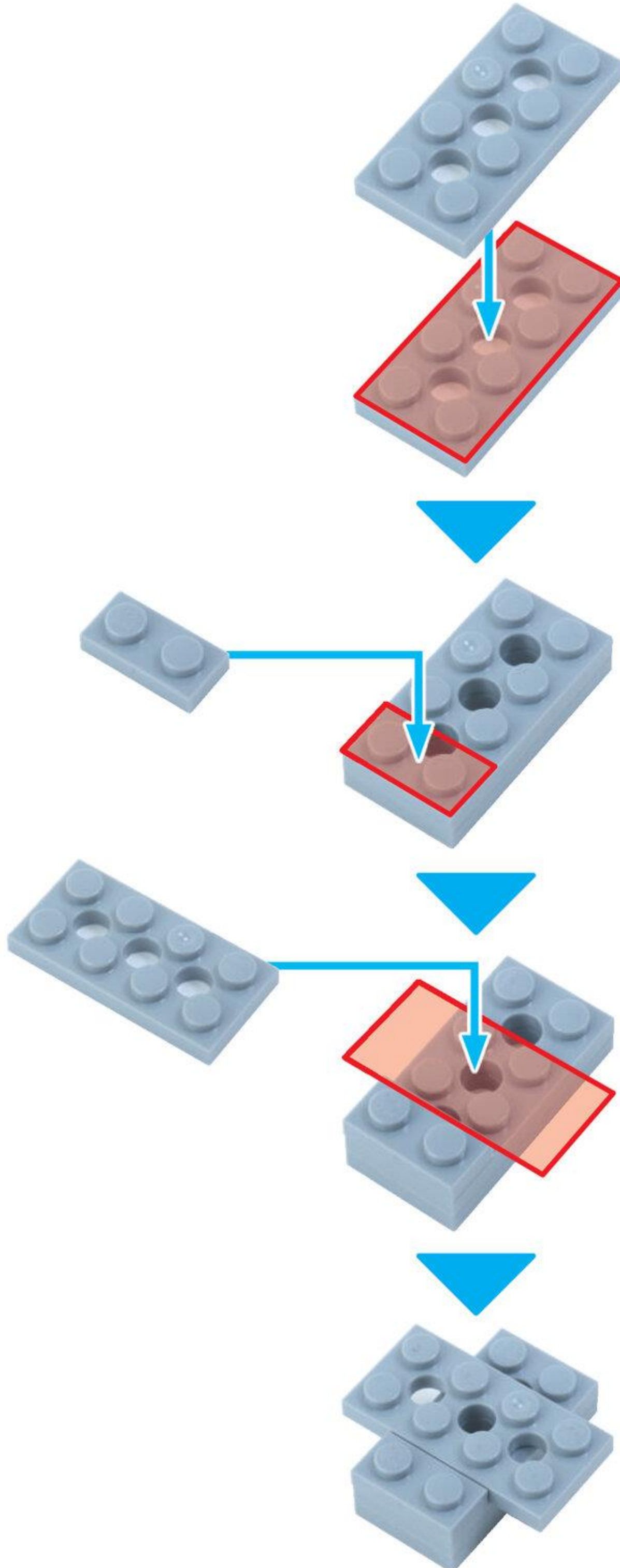

9

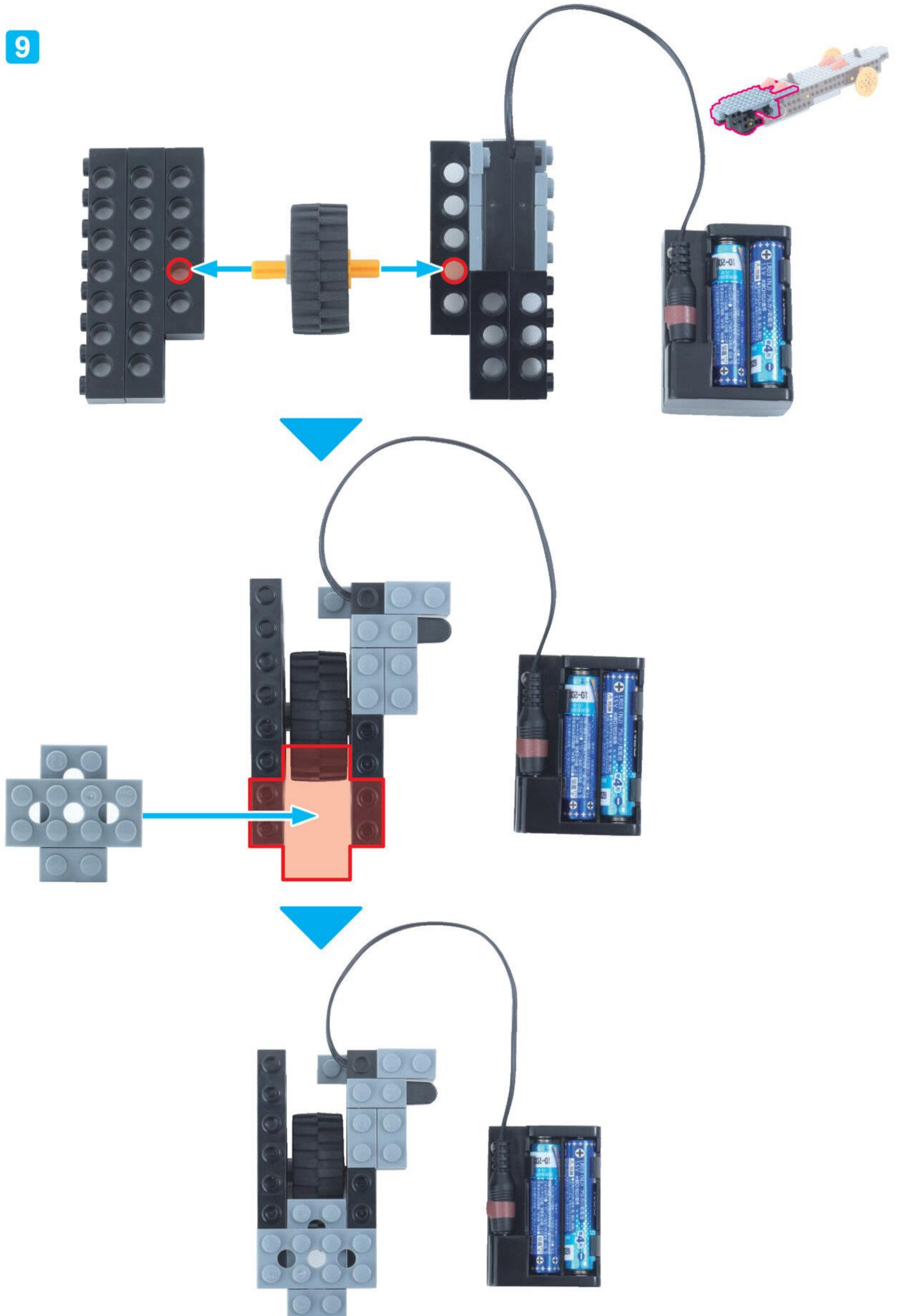

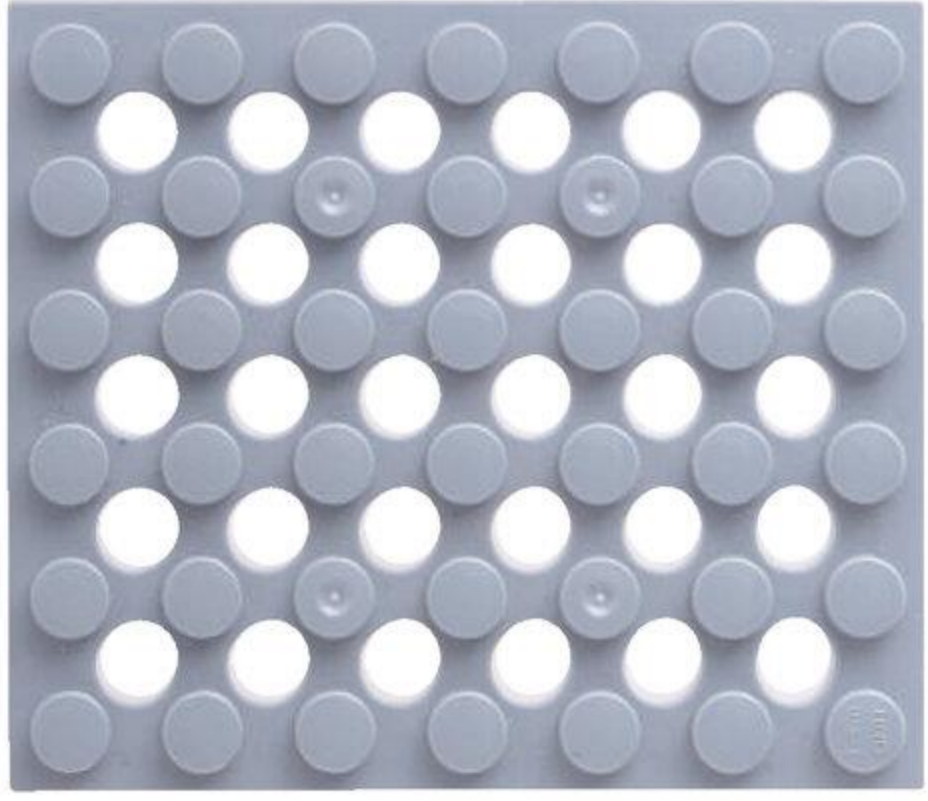

ふれえとろ  
プレートL 1こ



ふとふれえとゆんほち  
太プレート4ポチ 1こ



ふとふれえとほほち  
太プレート8ポチ 1こ



10

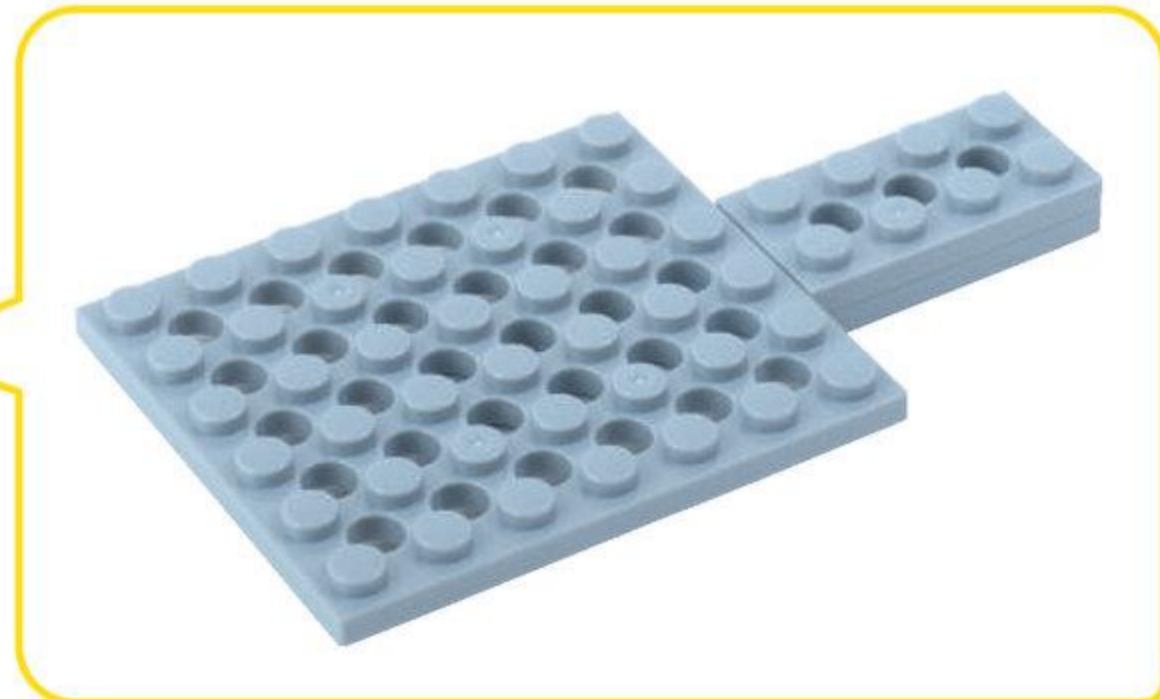
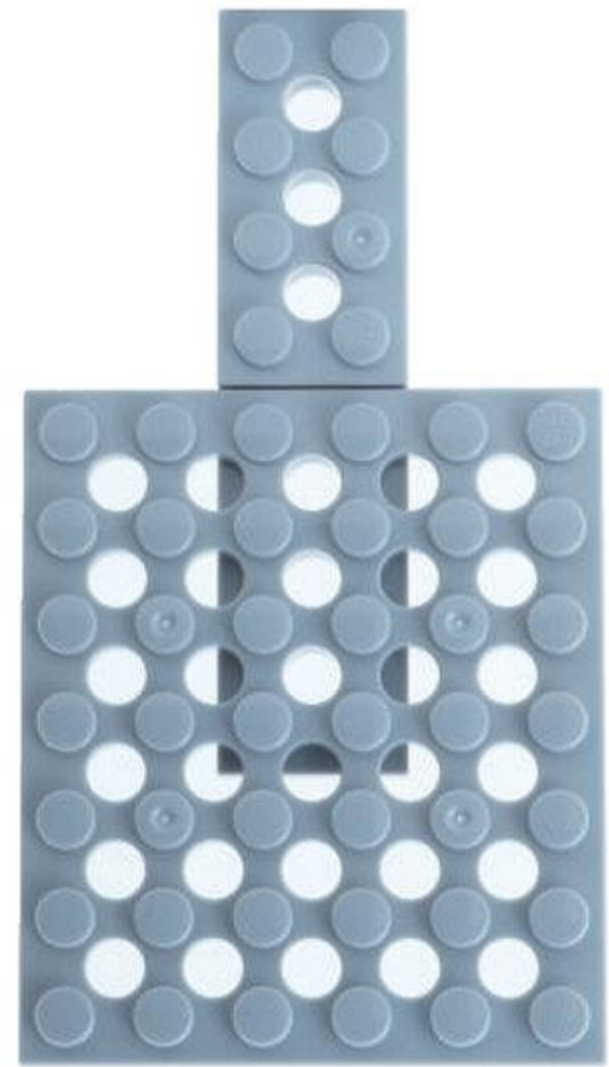
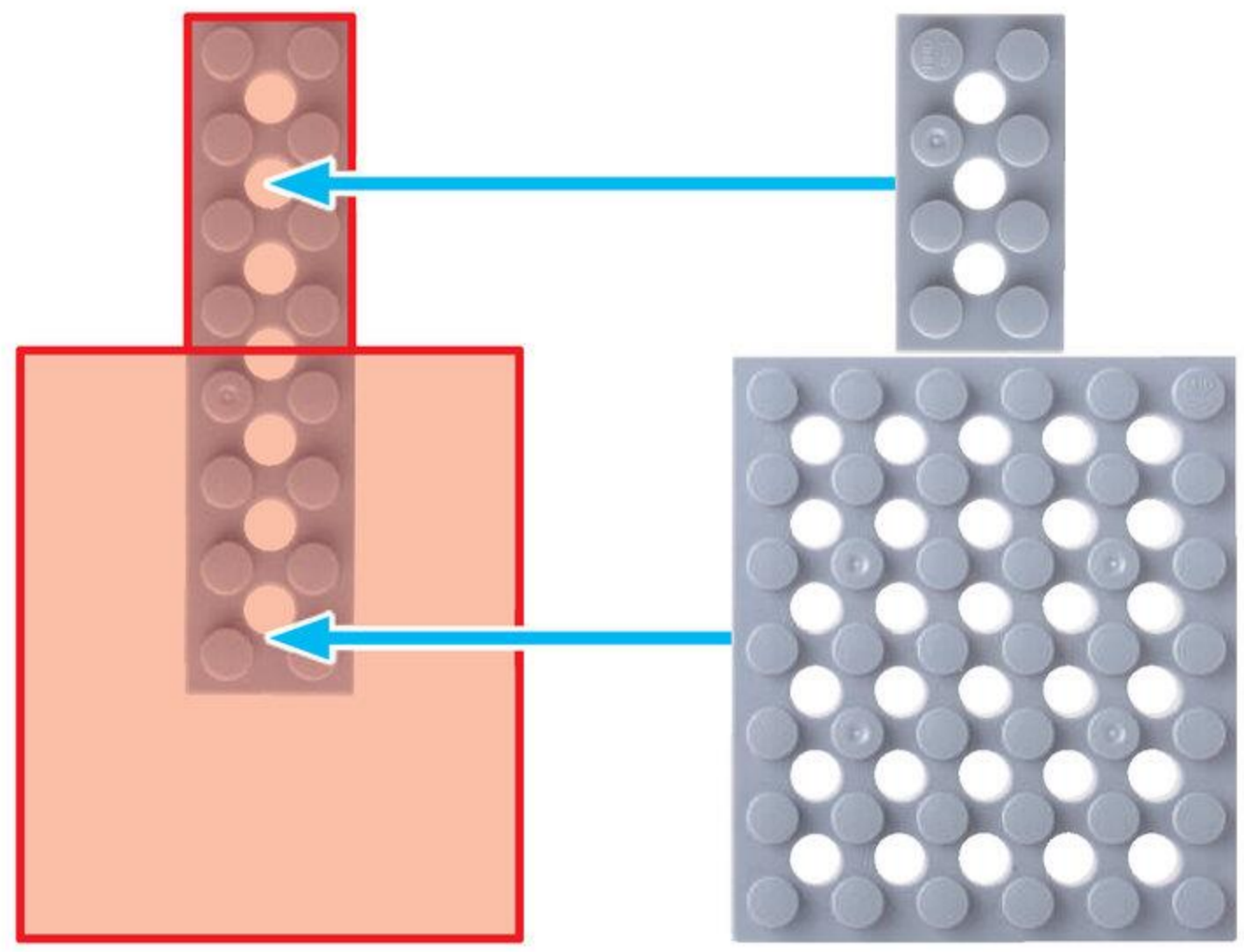

11

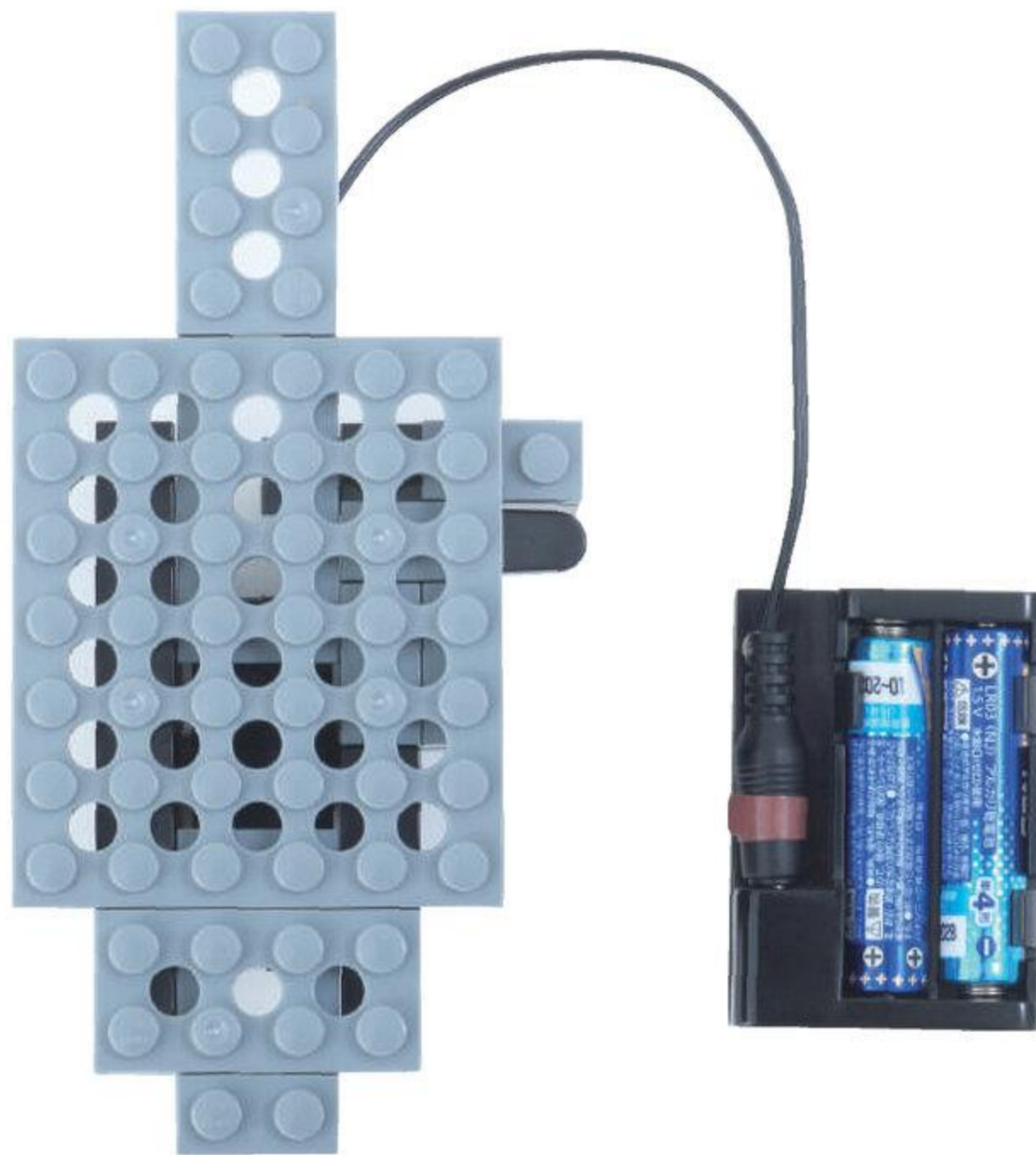
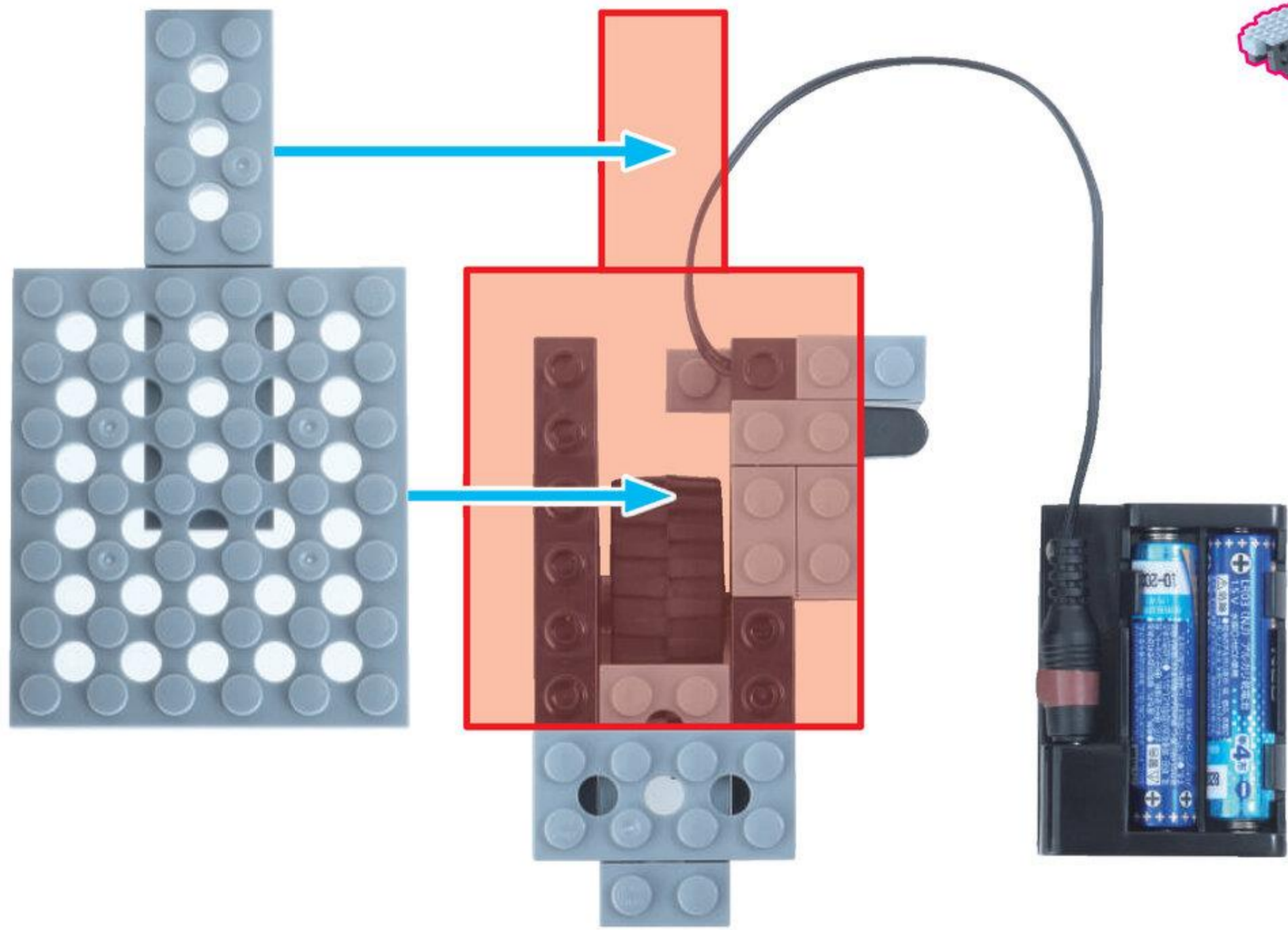

12

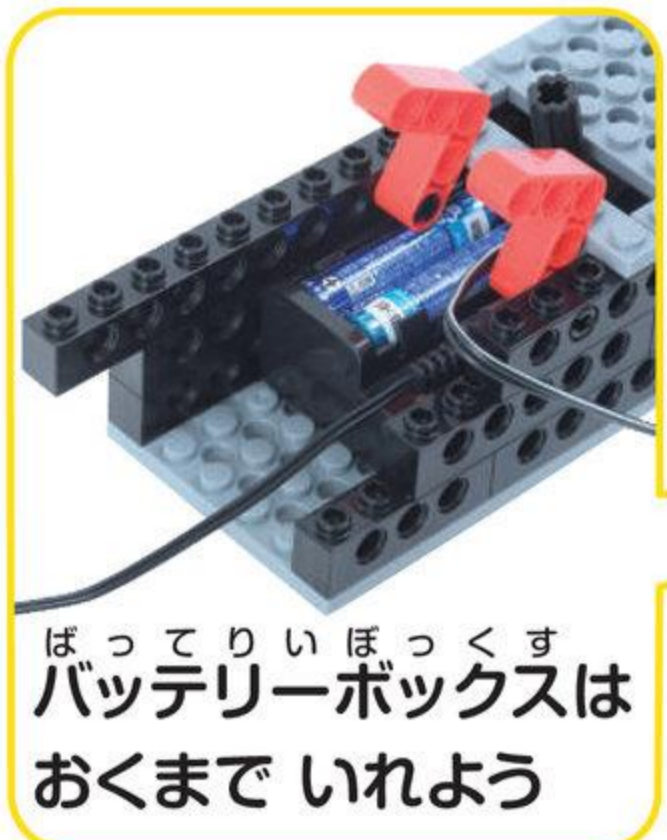
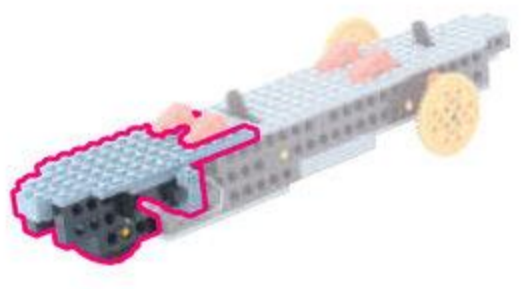

ばってりいほっくす  
バッテリーボックスは  
おくまで いれよう

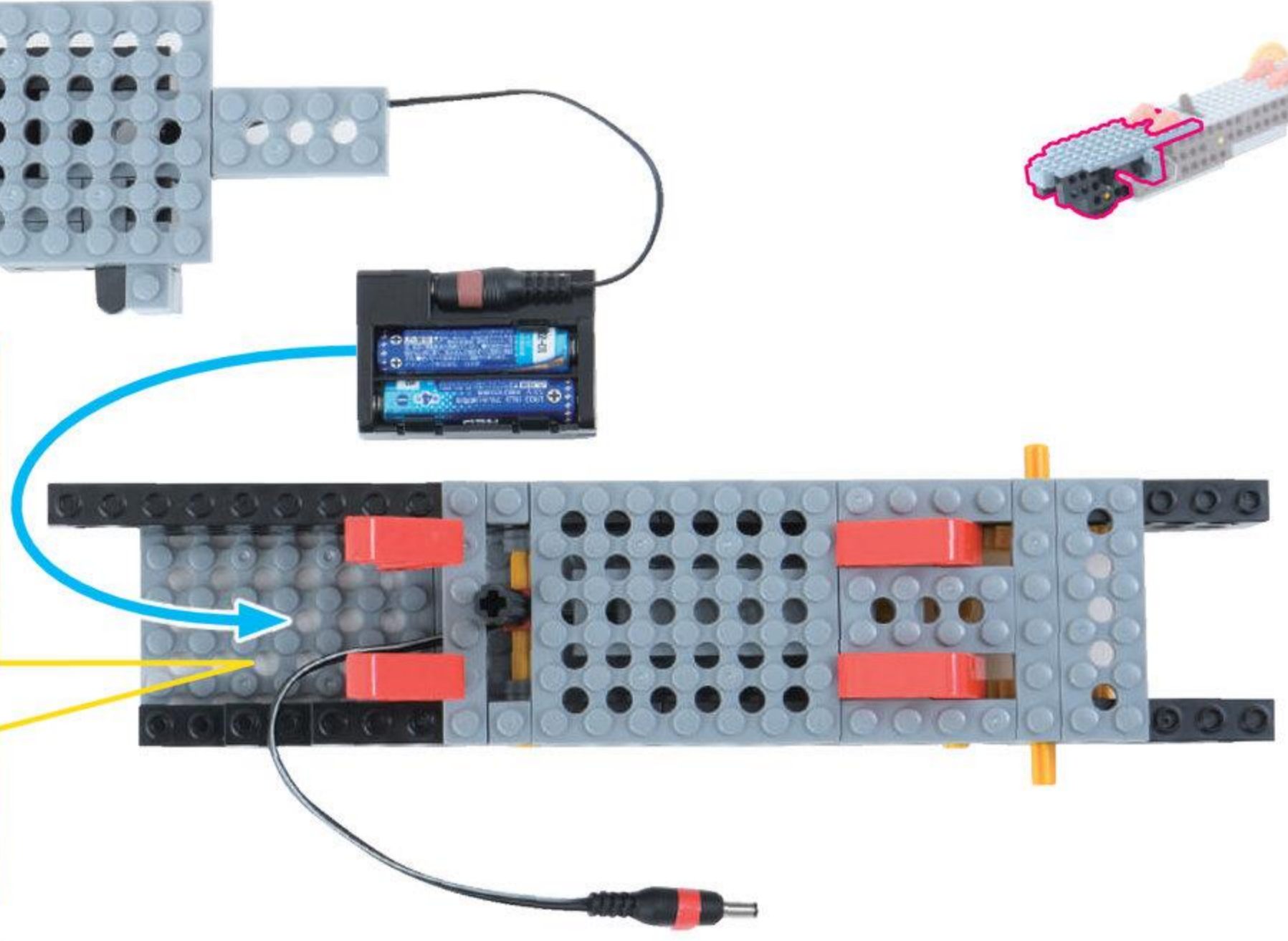

こおと  
コードはきれいにたたもう

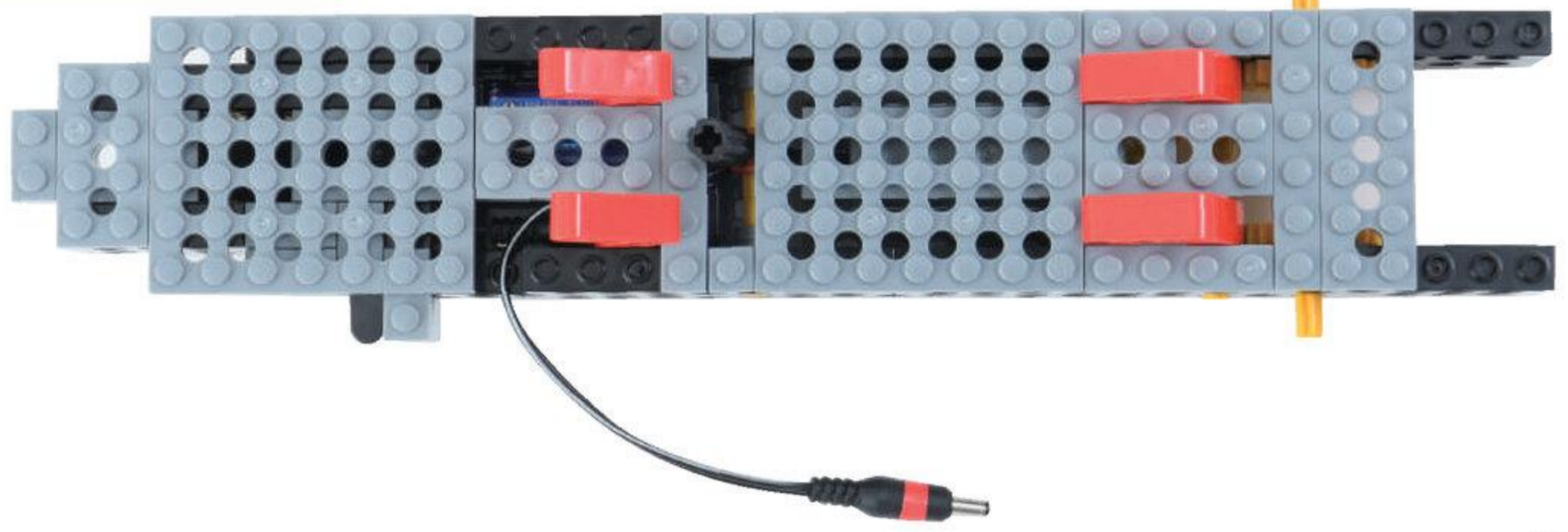

ほそぶれえとよんぼち  
細プレート4ポチ 2こ

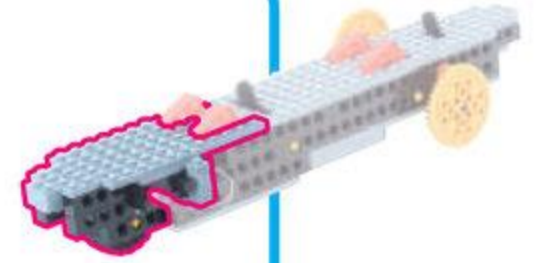

13

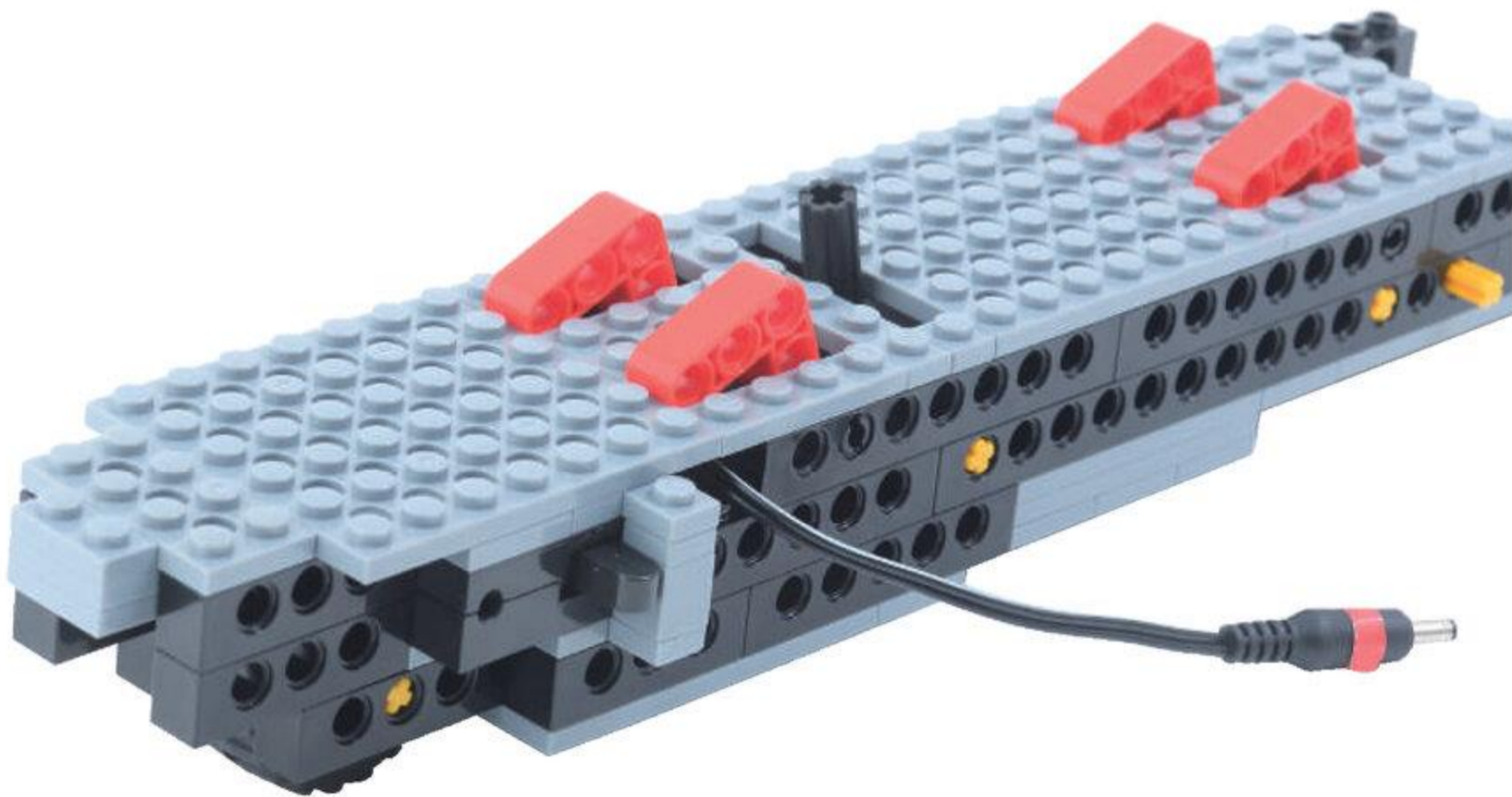
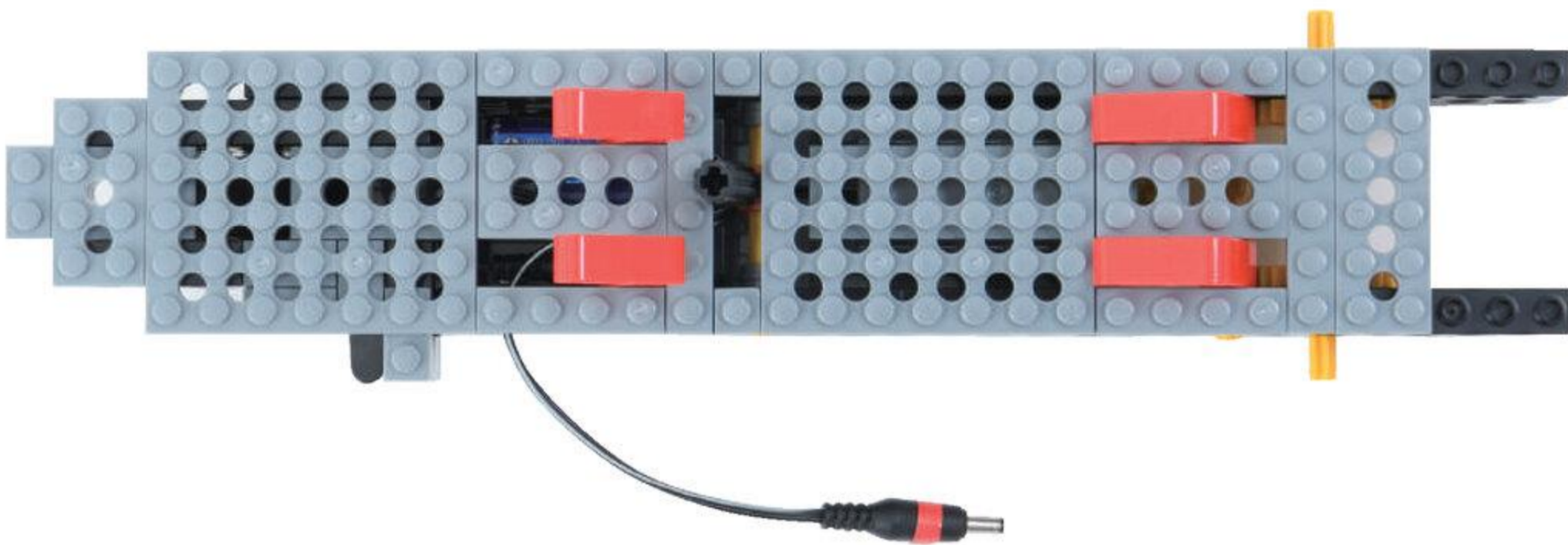
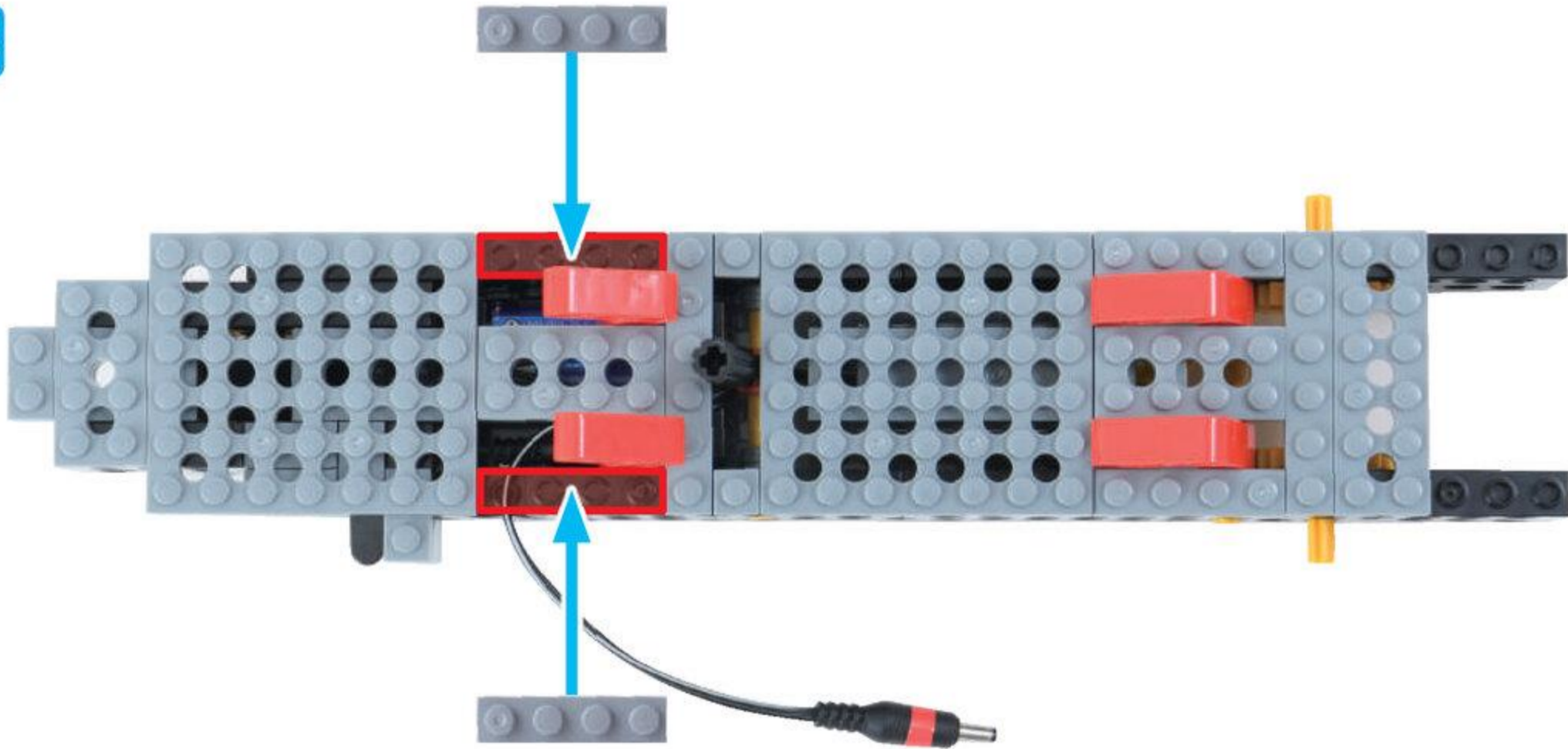

ふね(まえ)が  
かんせい!

やったね!

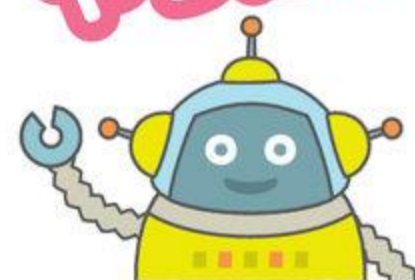







# 3 ふね (うしろ)

めやす 10 ぶん



ふっしゅ <b>ブッシュ 2こ</b>  しゃふとよん ぽち <b>シャフト 4 ポチ 1こ</b>  ていじょいんと <b>T ジョイント 1こ</b> 	ながさに ちゅうい	しゃふとじょいんと <b>シャフトジョイント 1こ</b>  くるしゃふと いてんこ ぽち <b>黒シャフト 1.5 ポチ 1こ</b>  みじかい ながい
--	--------------	---

1

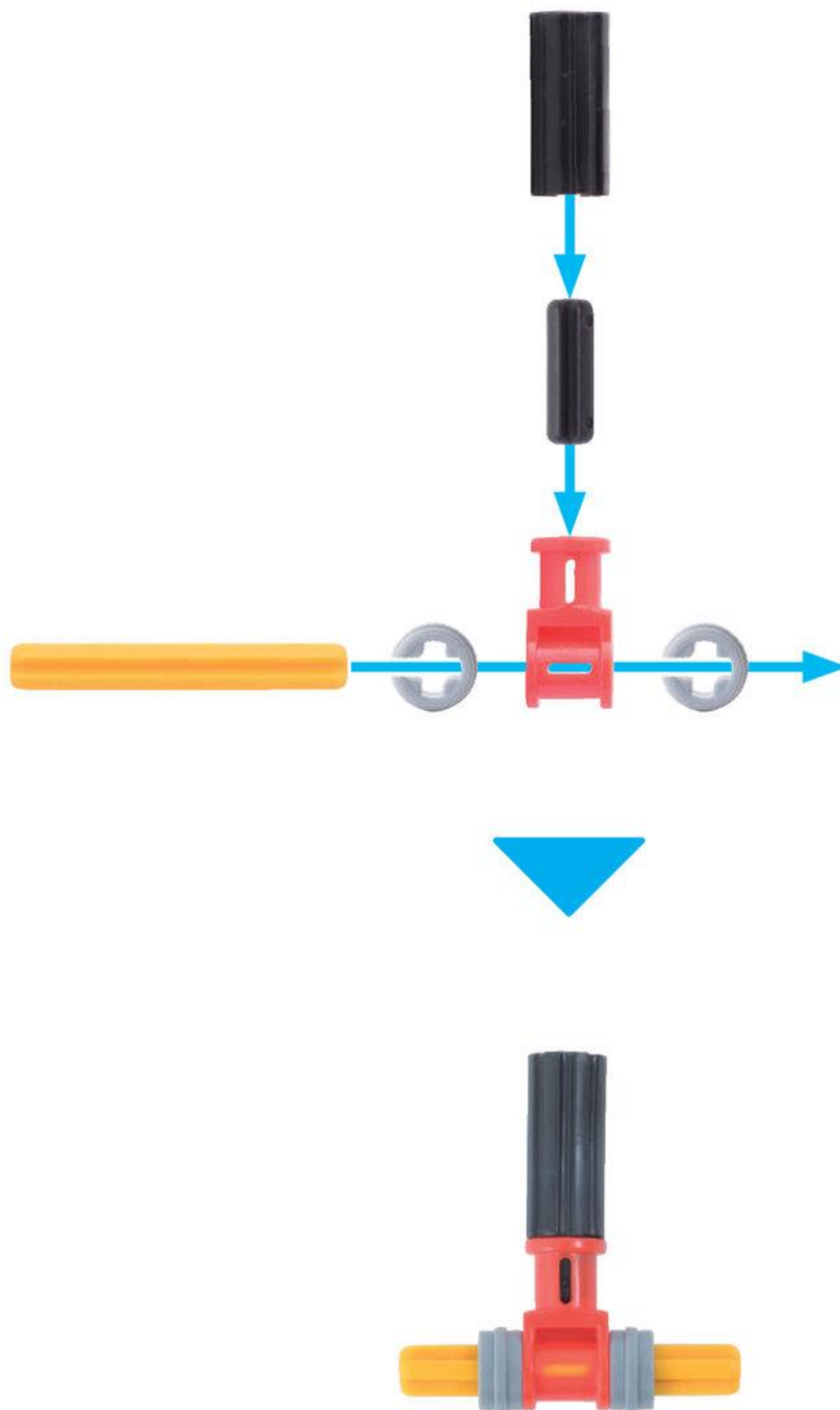

びいむよんぼち  
ビーム 4 ポチ 2こ



びいむろくぼち  
ビーム 6 ポチ 2こ



2

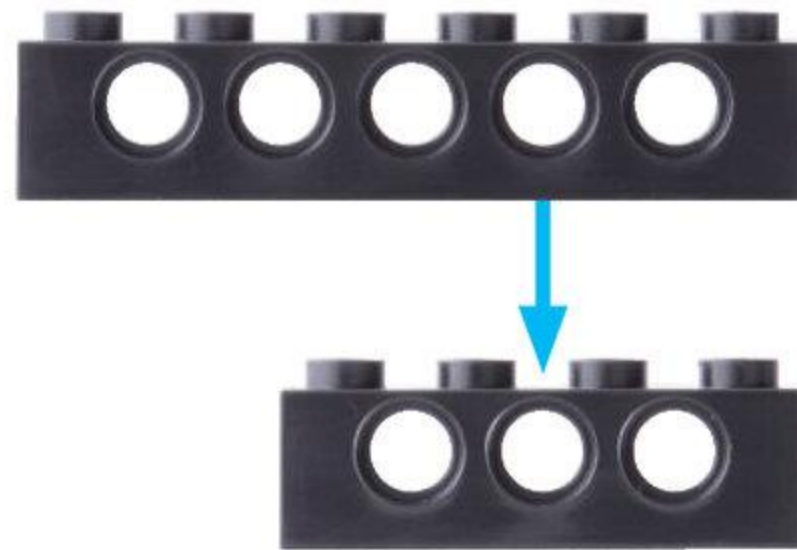
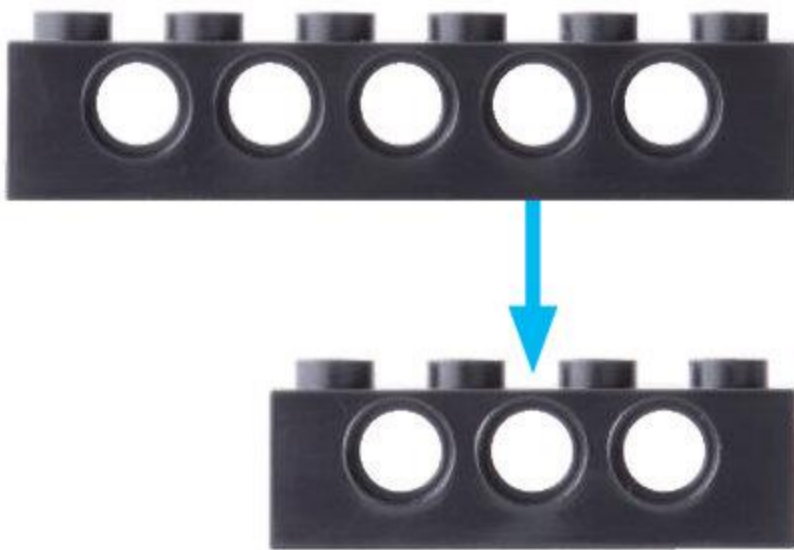

ほそぶれえとよんぼち  
細プレート 4 ポチ 1こ



ふとぶれえとろくぼち  
太プレート 6 ポチ 1こ



3

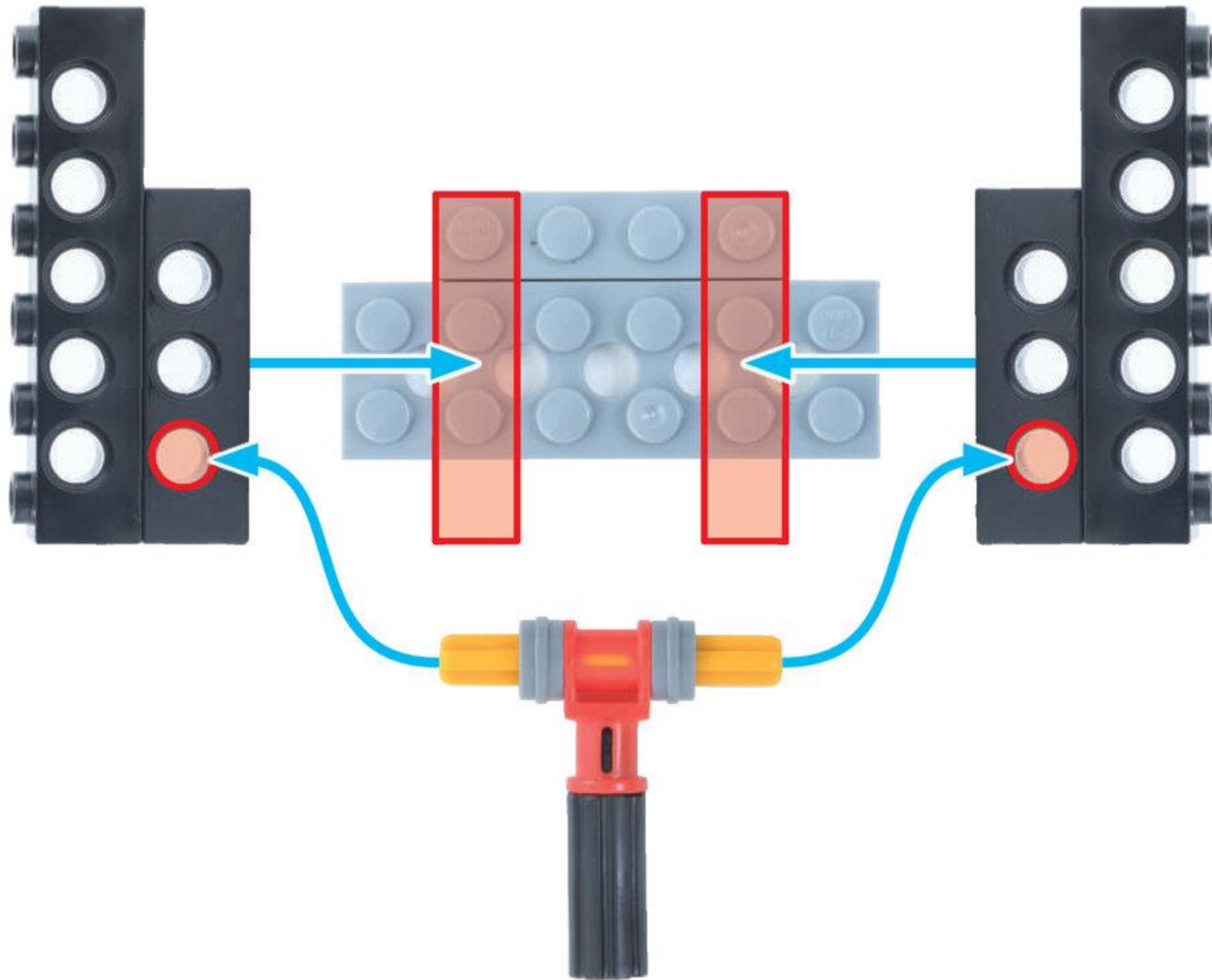

びいむよんぼち  
ビーム 4 ポチ 2こ



ふとぶれえとよんぼち  
太プレート 4 ポチ 1こ



ほそぶれえとよんぼち  
細プレート 4 ポチ 1こ



ほそぶれえとにぼち  
細プレート 2 ポチ 1こ



4

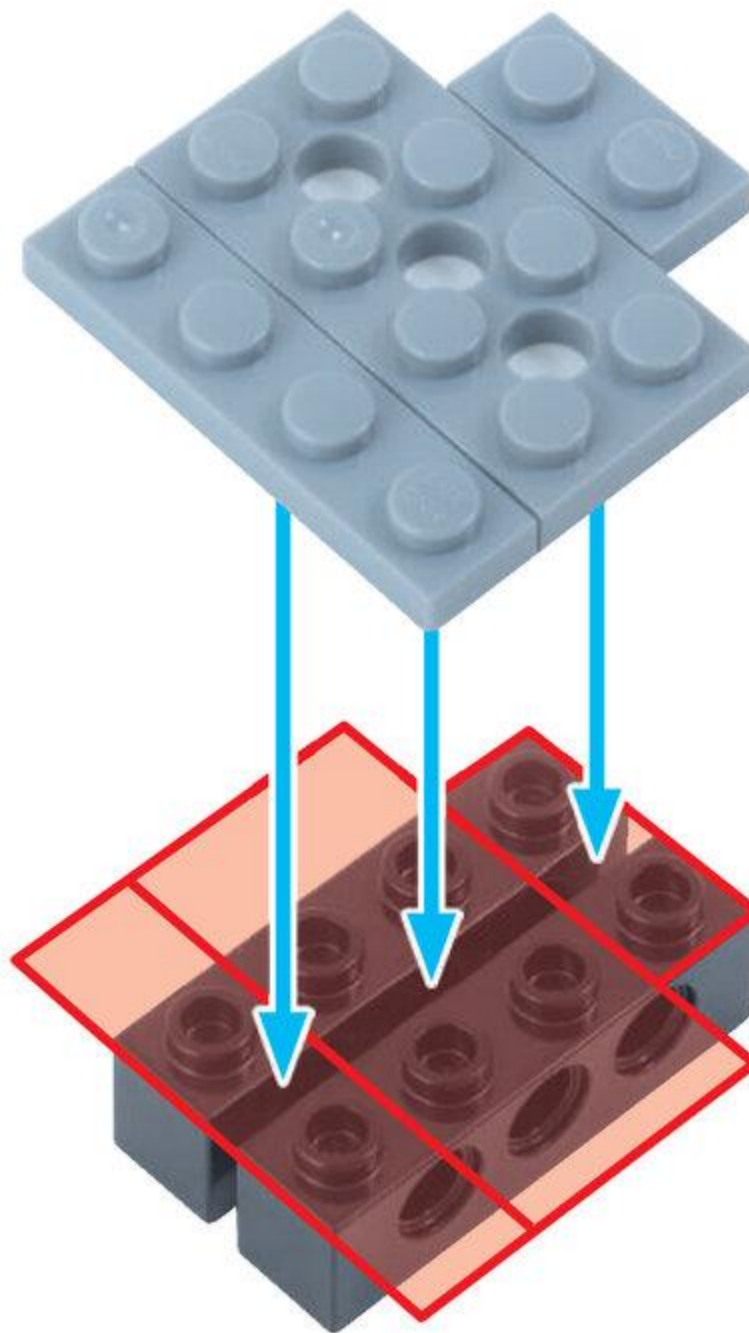

5

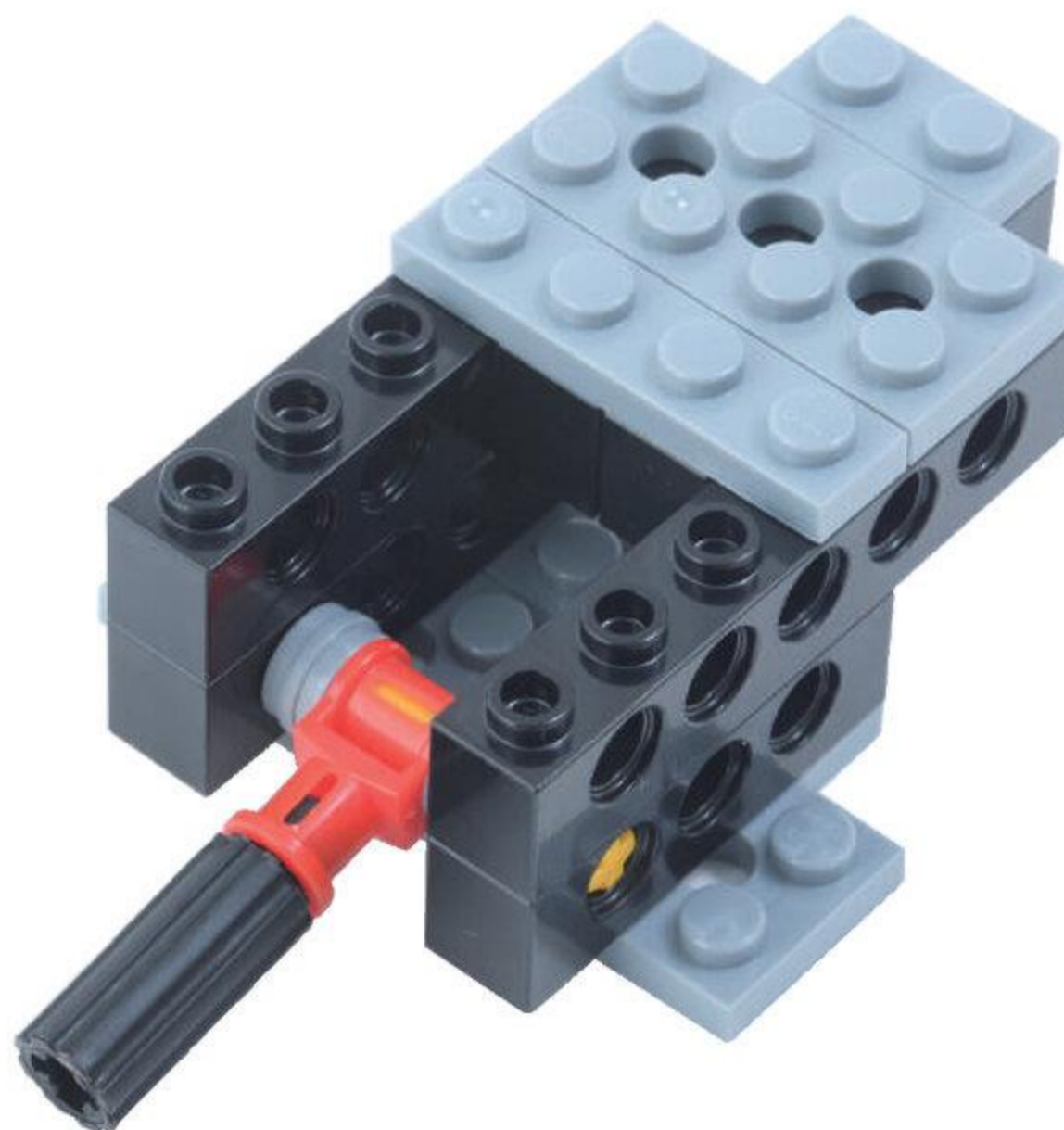
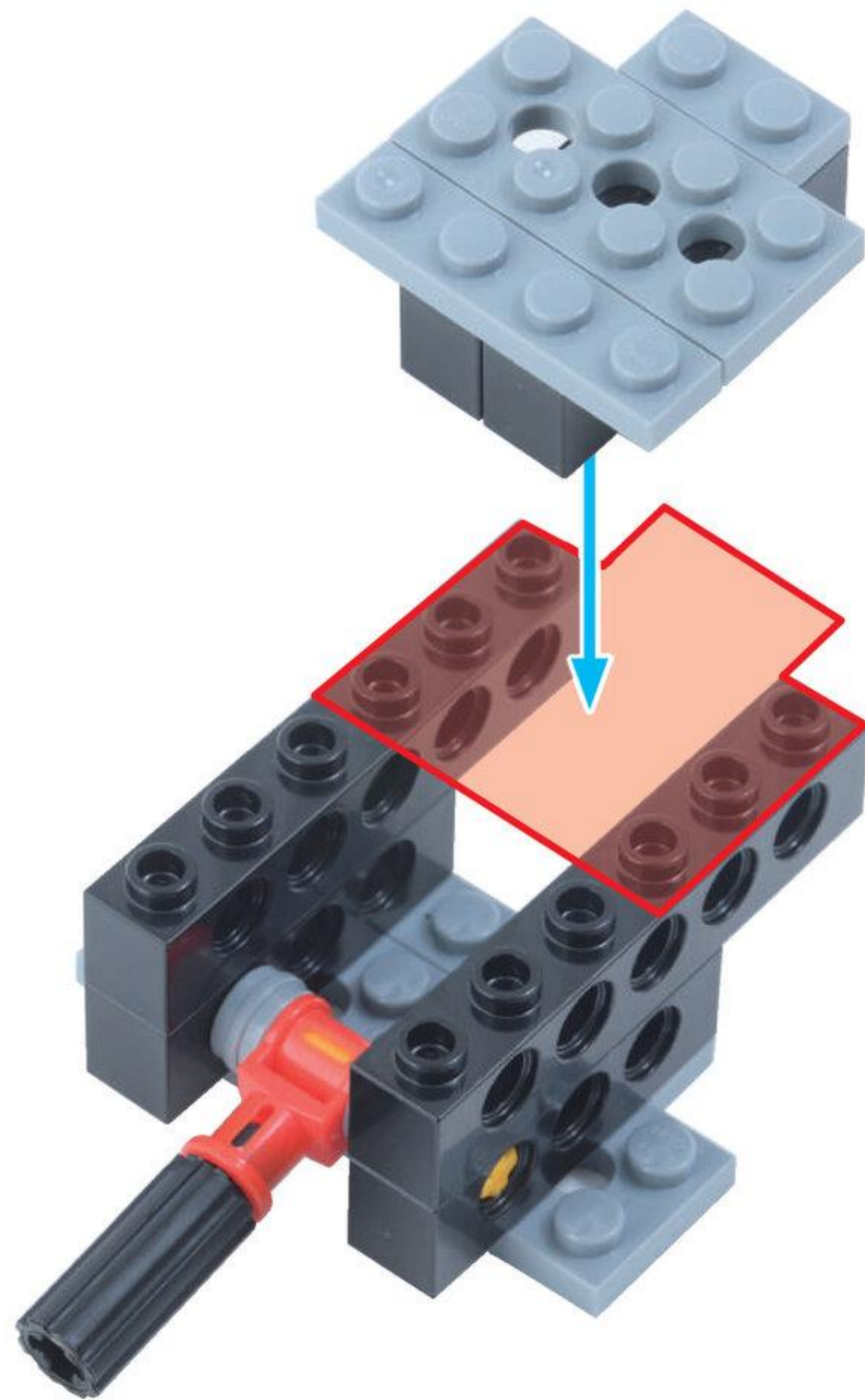

ほそぶれえとよんぼち  
細プレート4ポチ 1こ

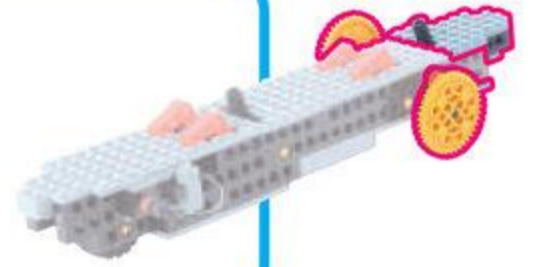

6

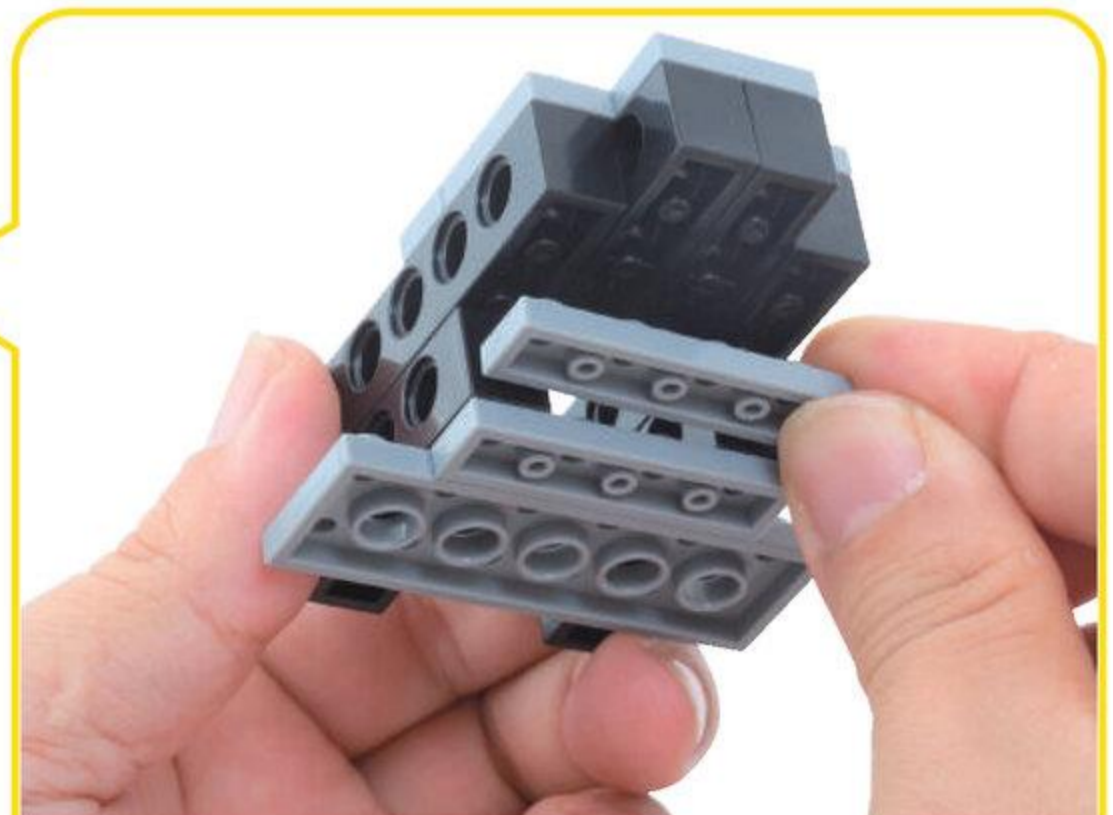
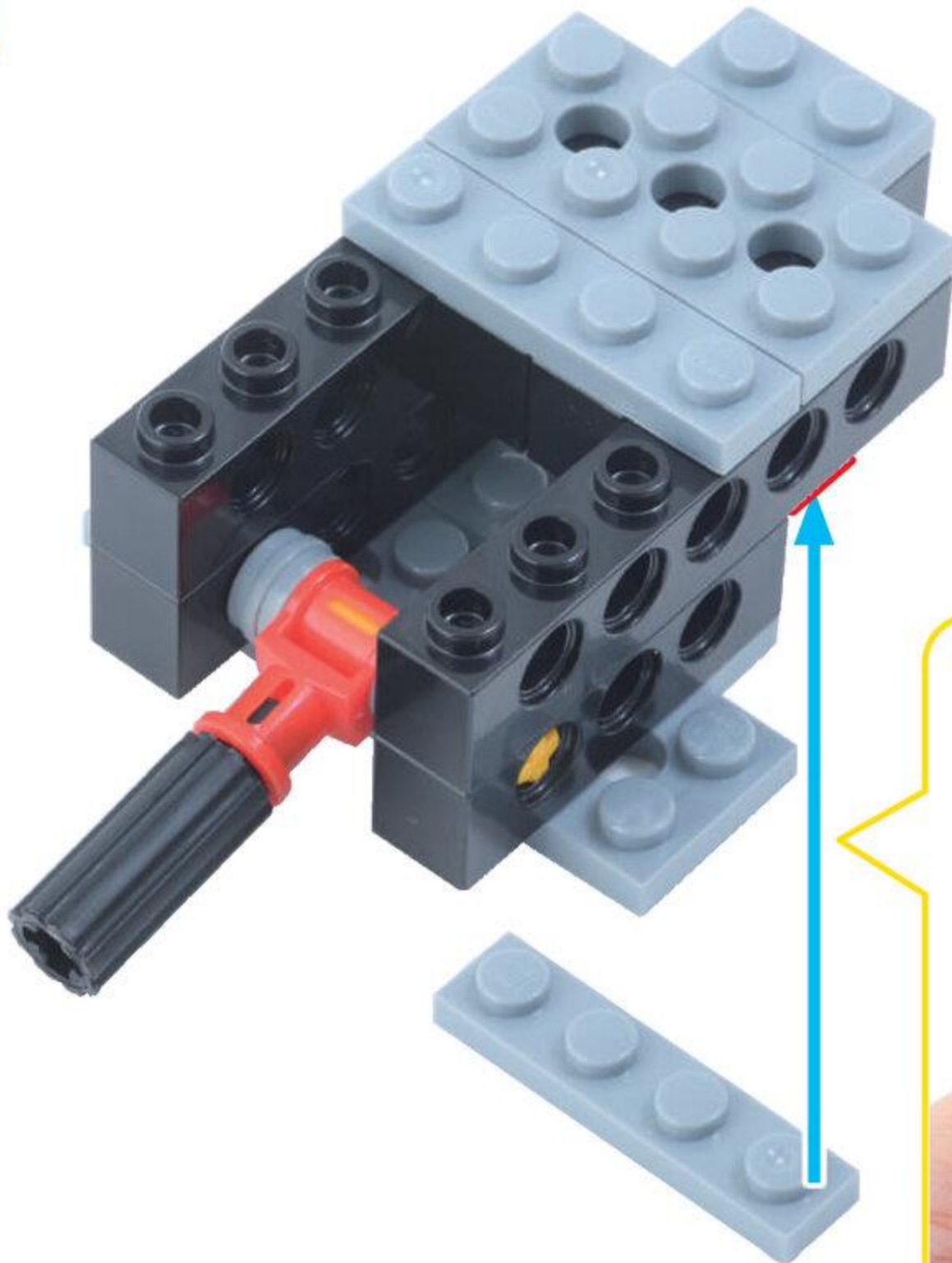

したから とりつけるよ

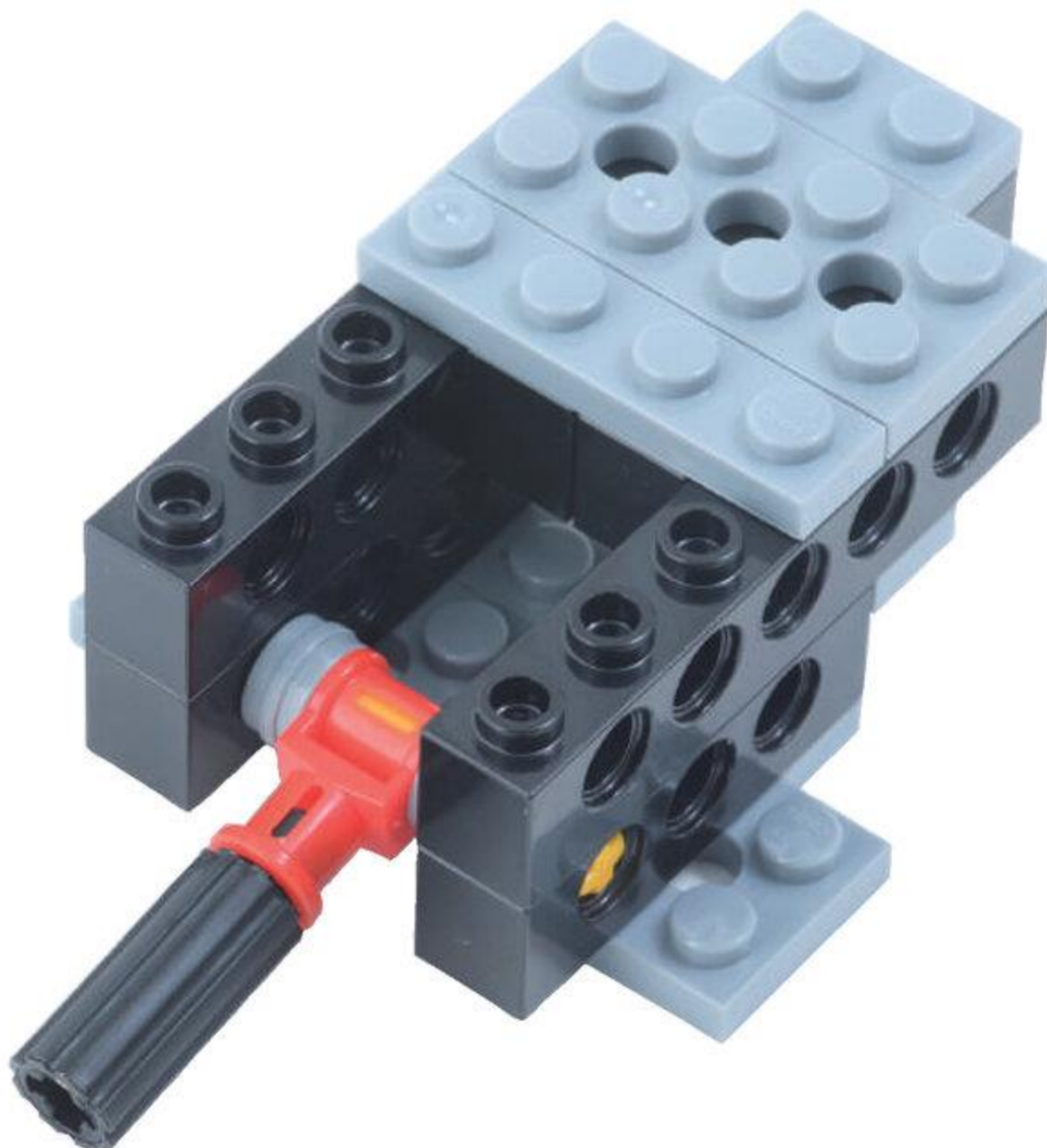

7

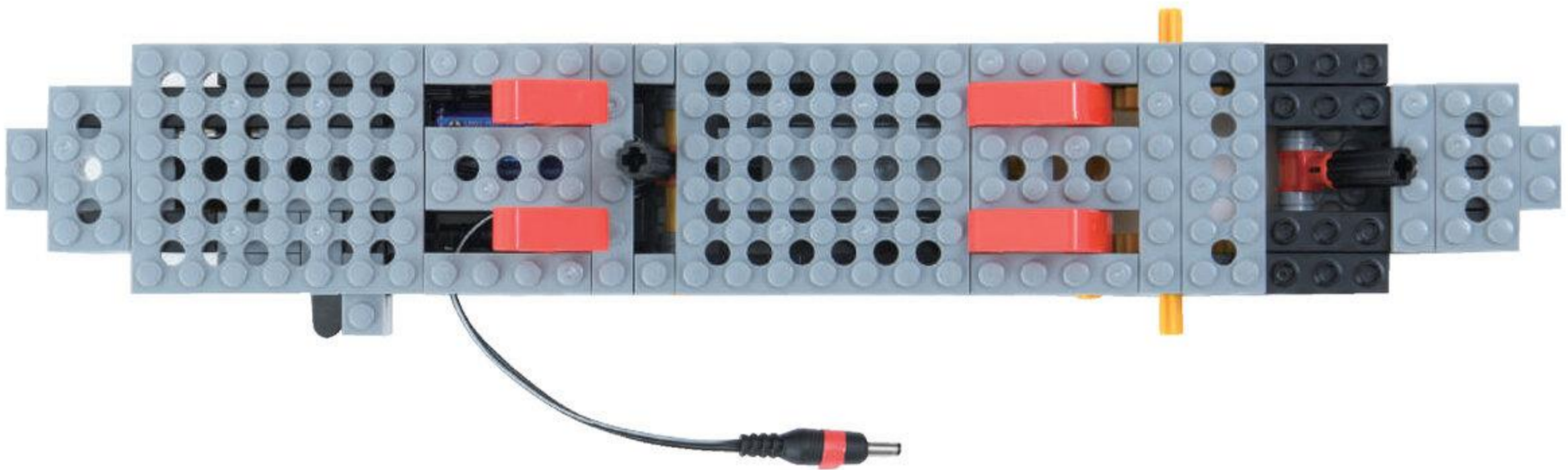
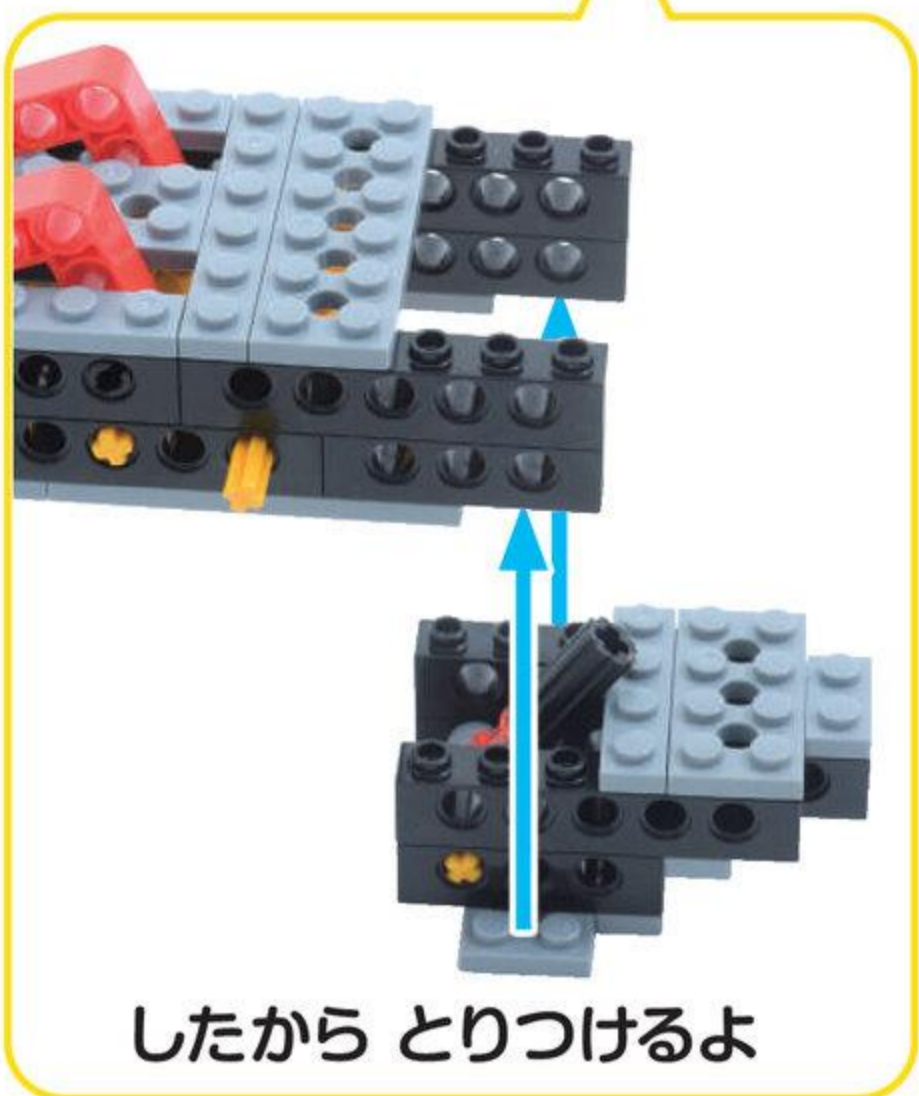
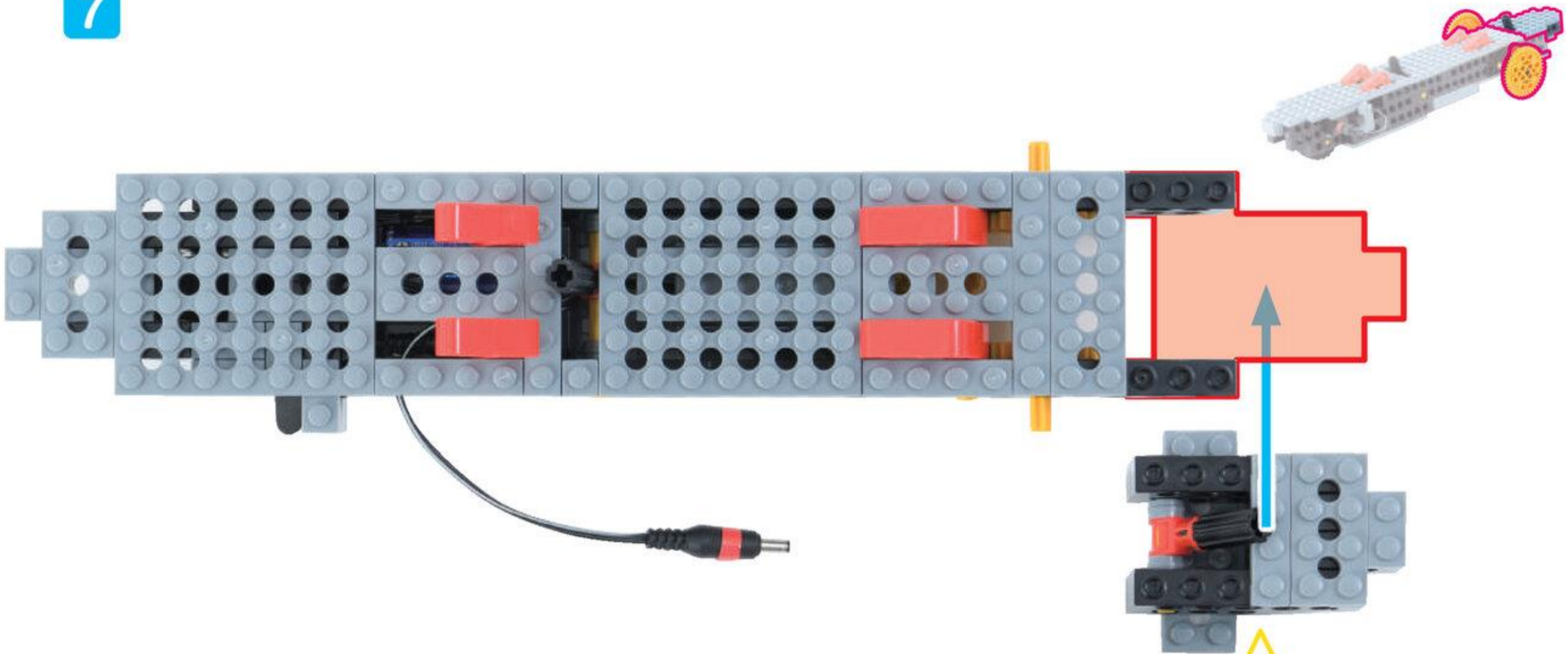

ふとぶれえとろくぼち  
太プレート6ポチ 1こ



ほそぶれえとにぼち  
細プレート2ポチ 2こ

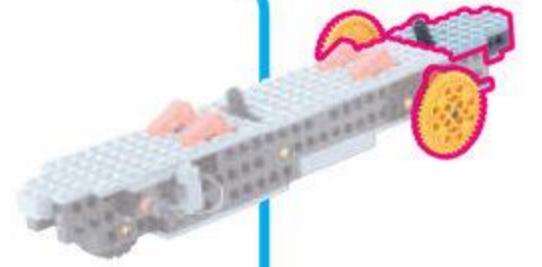

8

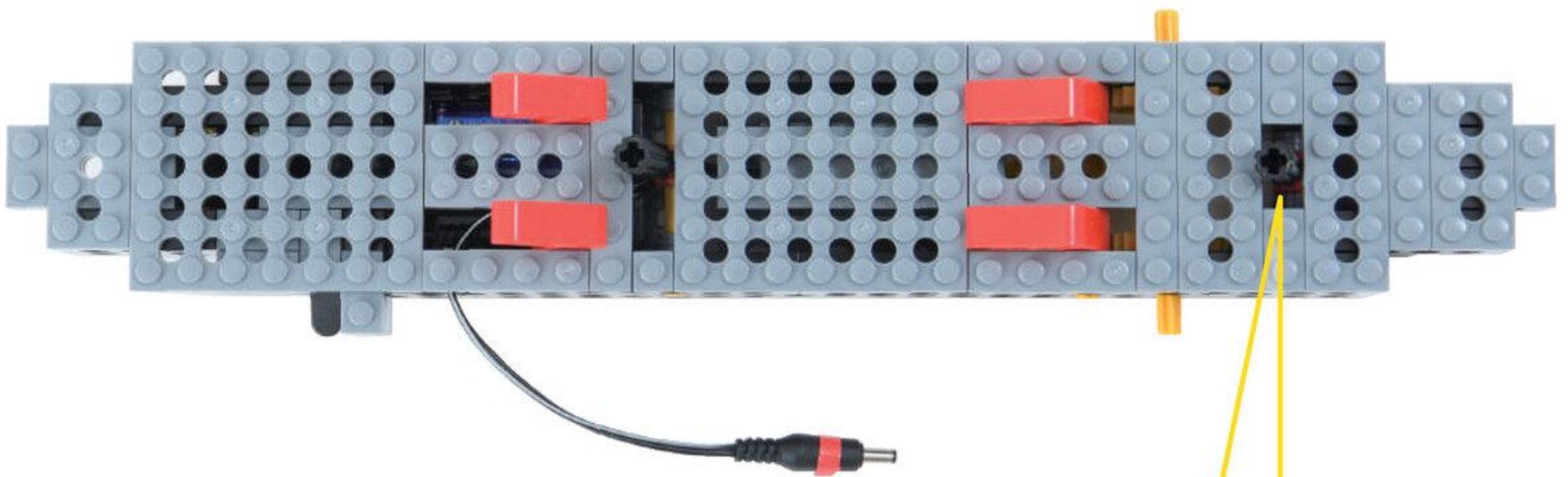
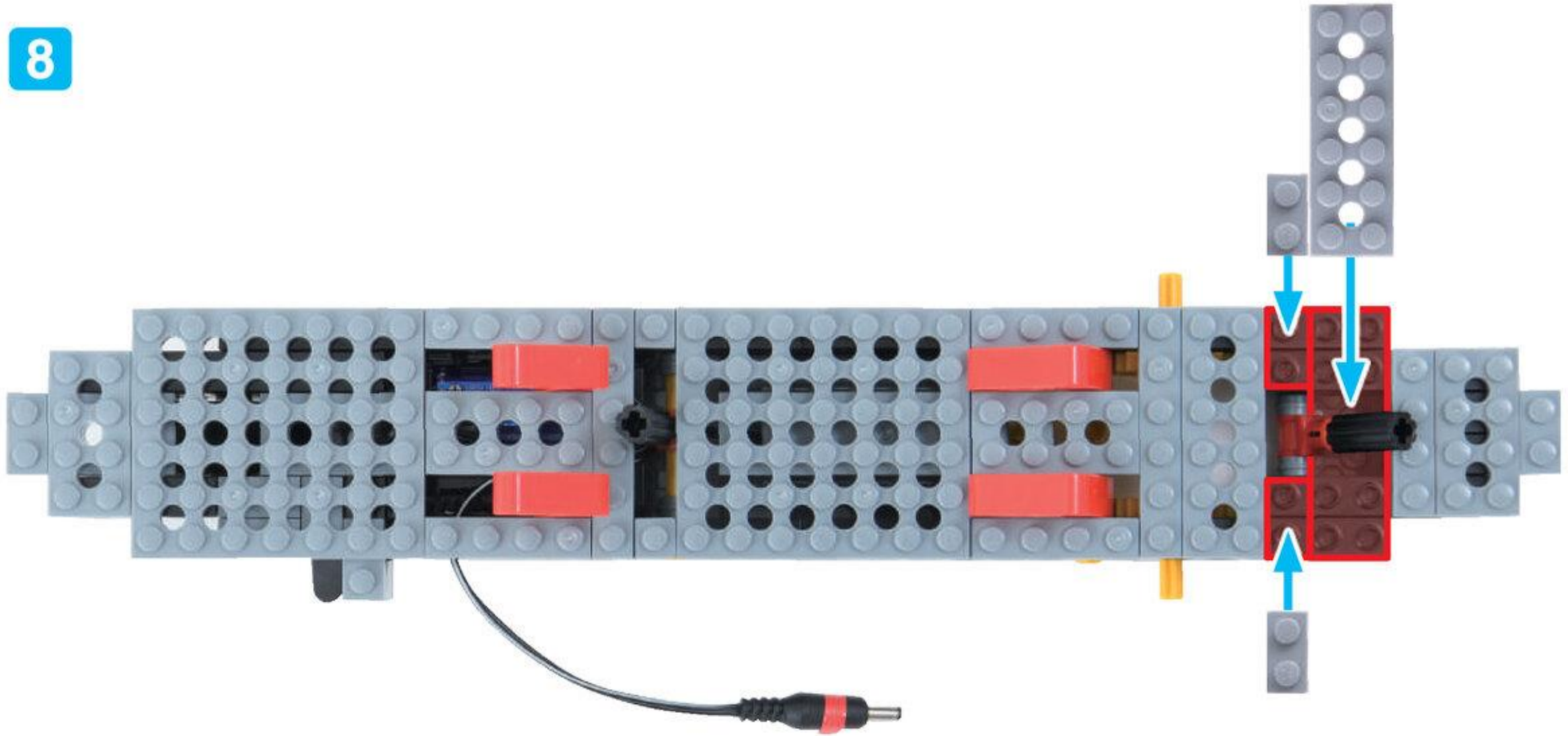

しゃふとじょいんと  
シャフトジョイントのむきにちゅうい





ぎあえる  
ギア L 2こ

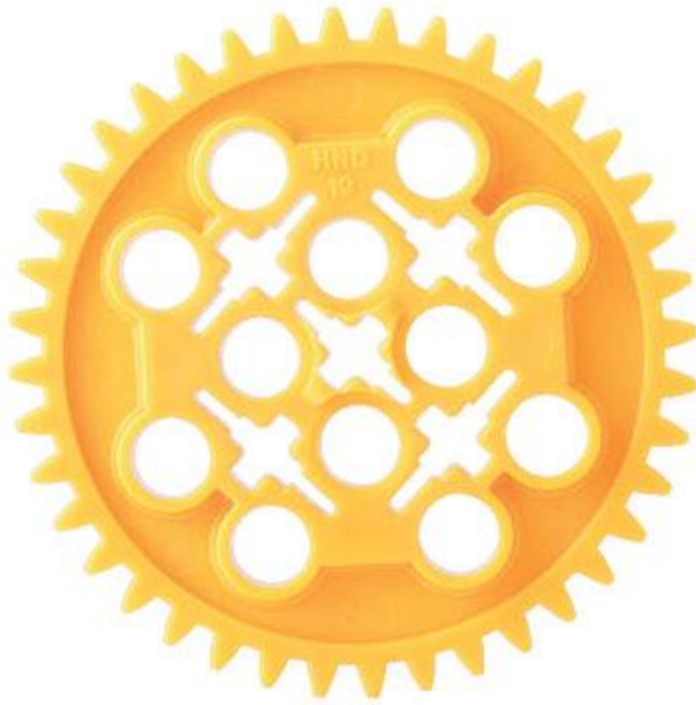

くろしゃふとにほち  
黒シャフト 2 ポチ 2こ



ろっどさんあな  
ロッド 3 アナ 2こ



9

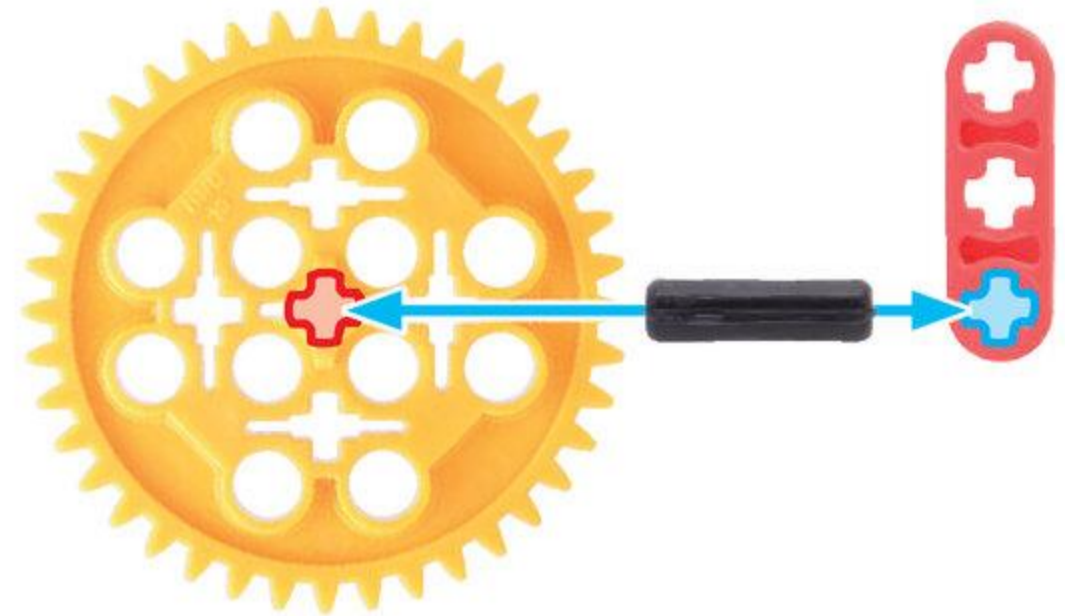
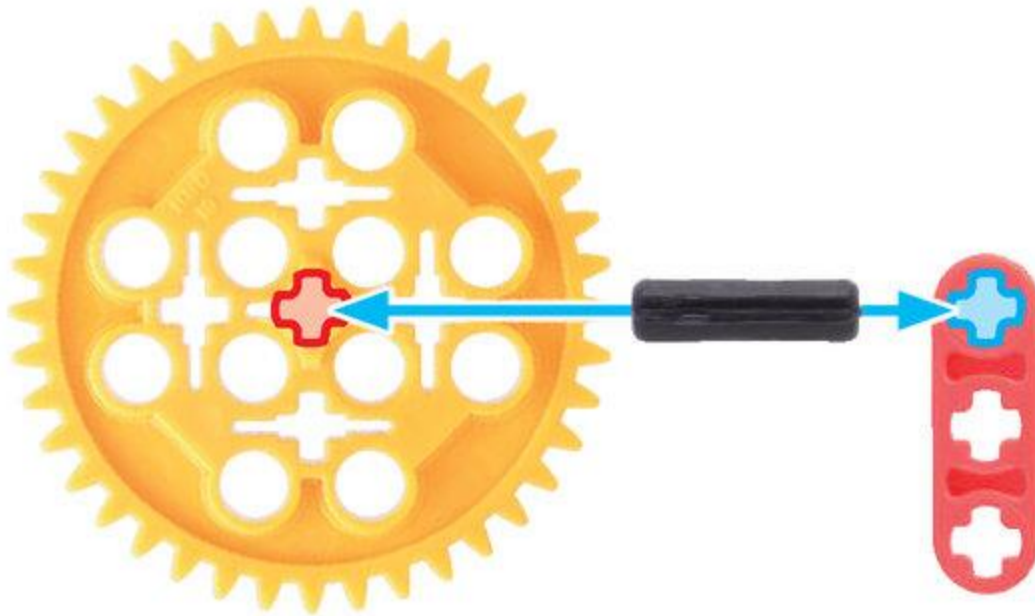

10

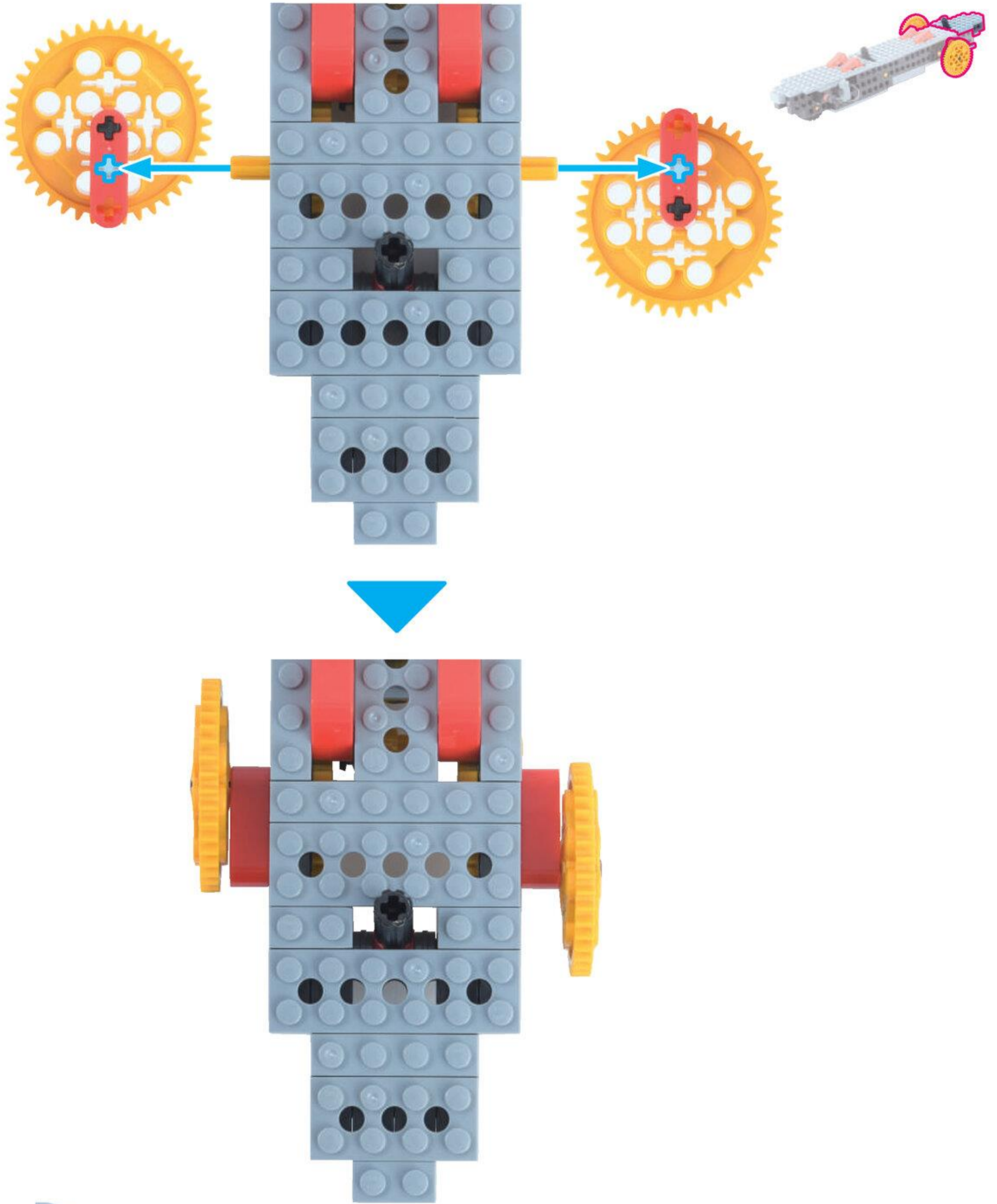

ふね (うしろ) が  
かんせい!

やったね!

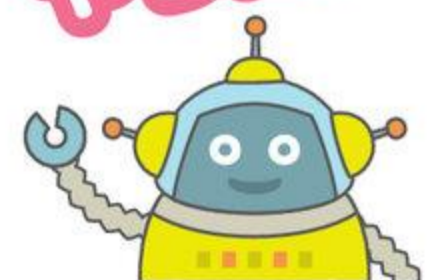

# ロボットをうごかそう

めやす 10 ぶん

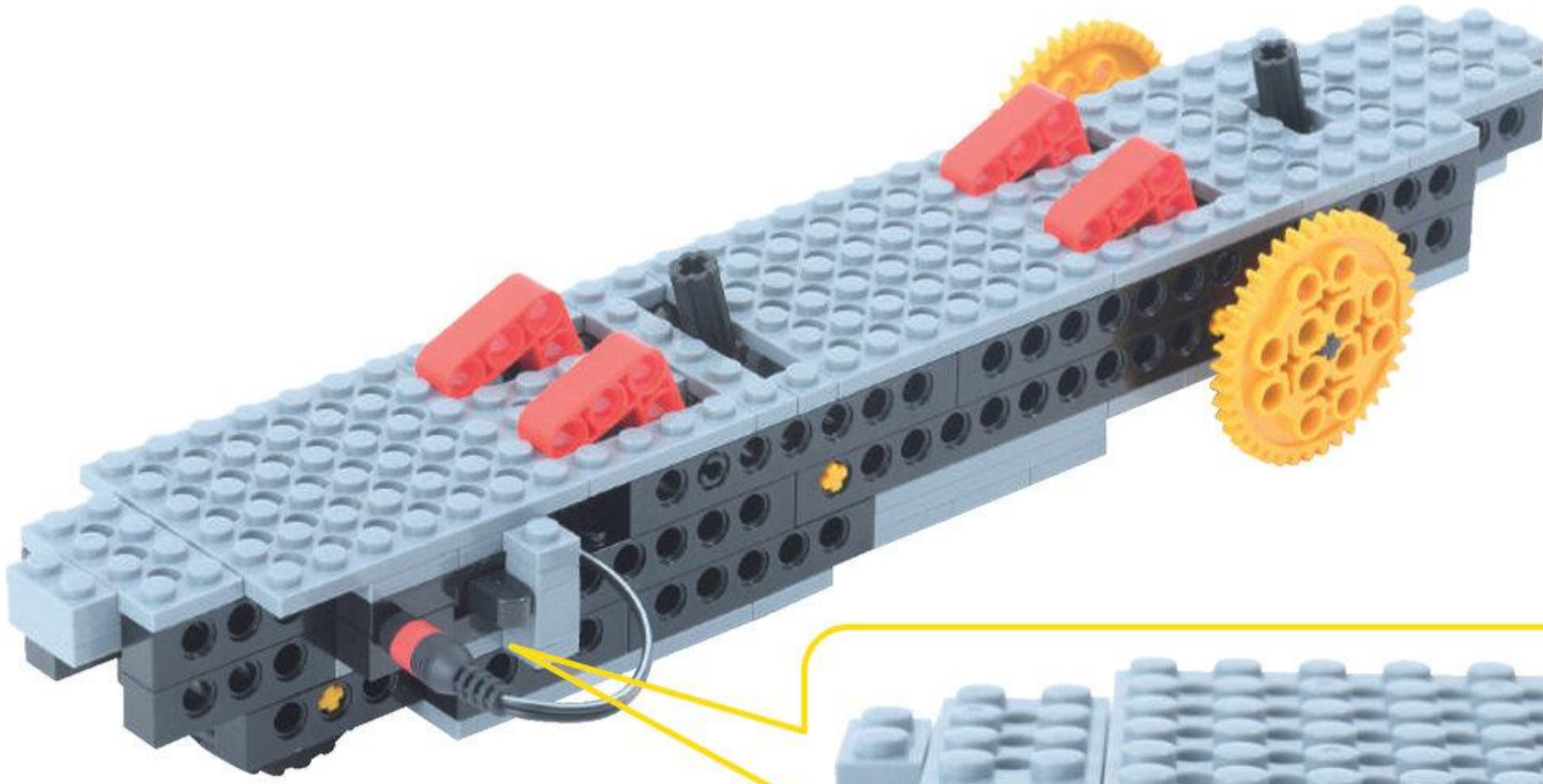

ぶらぐ  
プラグをさしこんだら  
やじるしのむきに  
すいっち  
スイッチをいれよう

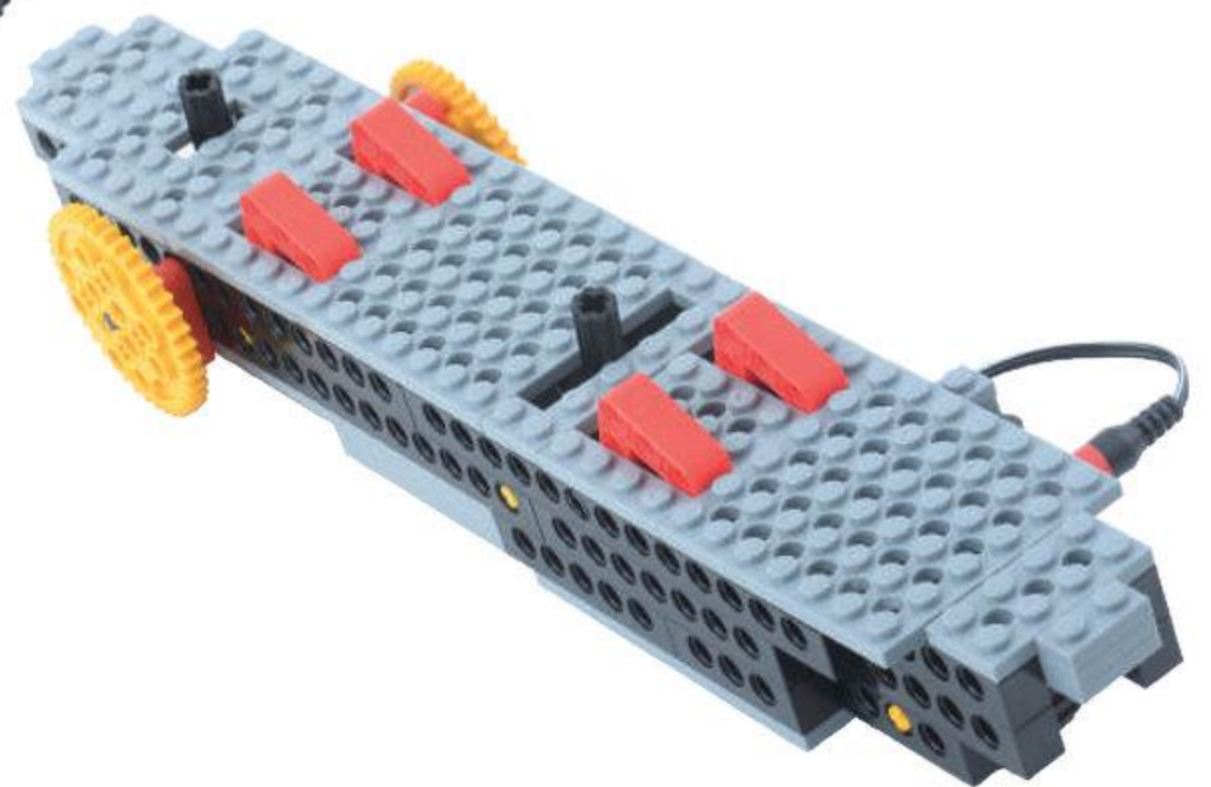

ふねはゆれながら  
すすんだかな

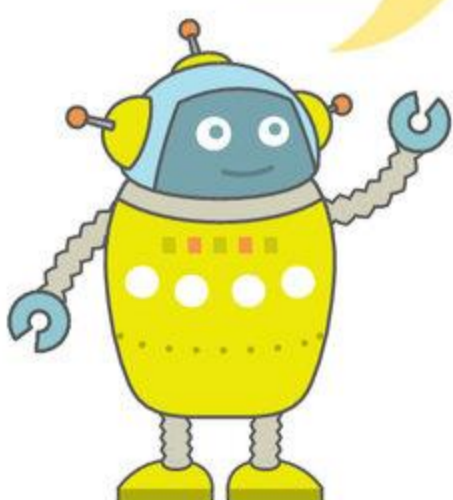

Q1 このパーツの <sup>ばあつ</sup>なまえは どれかな?



- ・ <sup>く</sup> <sup>ろ</sup> <sup>す</sup> <sup>じ</sup> <sup>ょ</sup> <sup>い</sup> <sup>ん</sup> <sup>と</sup> クロスジョイント
- ・ <sup>し</sup> <sup>ゃ</sup> <sup>ふ</sup> <sup>と</sup> <sup>じ</sup> <sup>ょ</sup> <sup>い</sup> <sup>ん</sup> <sup>と</sup> シャフトジョイント
- ・ <sup>あ</sup> <sup>な</sup> <sup>し</sup> <sup>ゃ</sup> <sup>ふ</sup> <sup>と</sup> <sup>じ</sup> <sup>ょ</sup> <sup>い</sup> <sup>ん</sup> <sup>と</sup> アナシャフトジョイント



Q2 <sup>あ</sup> <sup>な</sup> <sup>し</sup> <sup>ゃ</sup> <sup>ふ</sup> <sup>と</sup> <sup>じ</sup> <sup>ょ</sup> <sup>い</sup> <sup>ん</sup> <sup>と</sup> アナシャフトジョイントに  
とりつけられない <sup>ばあつ</sup>パーツは どれかな?



Q3 <sup>し</sup> <sup>ゃ</sup> <sup>ふ</sup> <sup>と</sup> <sup>じ</sup> <sup>ょ</sup> <sup>い</sup> <sup>ん</sup> <sup>と</sup> シャフトジョイントに **とりつけられる** <sup>ばあつ</sup>パーツは どれかな?





Human

ヒューマンアカデミー ジュニア  
STEAMスクール



ロボット教室

# ロボットのきょうかしよ

プレプライマリーコース B

2

おやこで <sup>わんつう</sup>ワンツウ「<sup>かやっくん</sup>カヤックン」

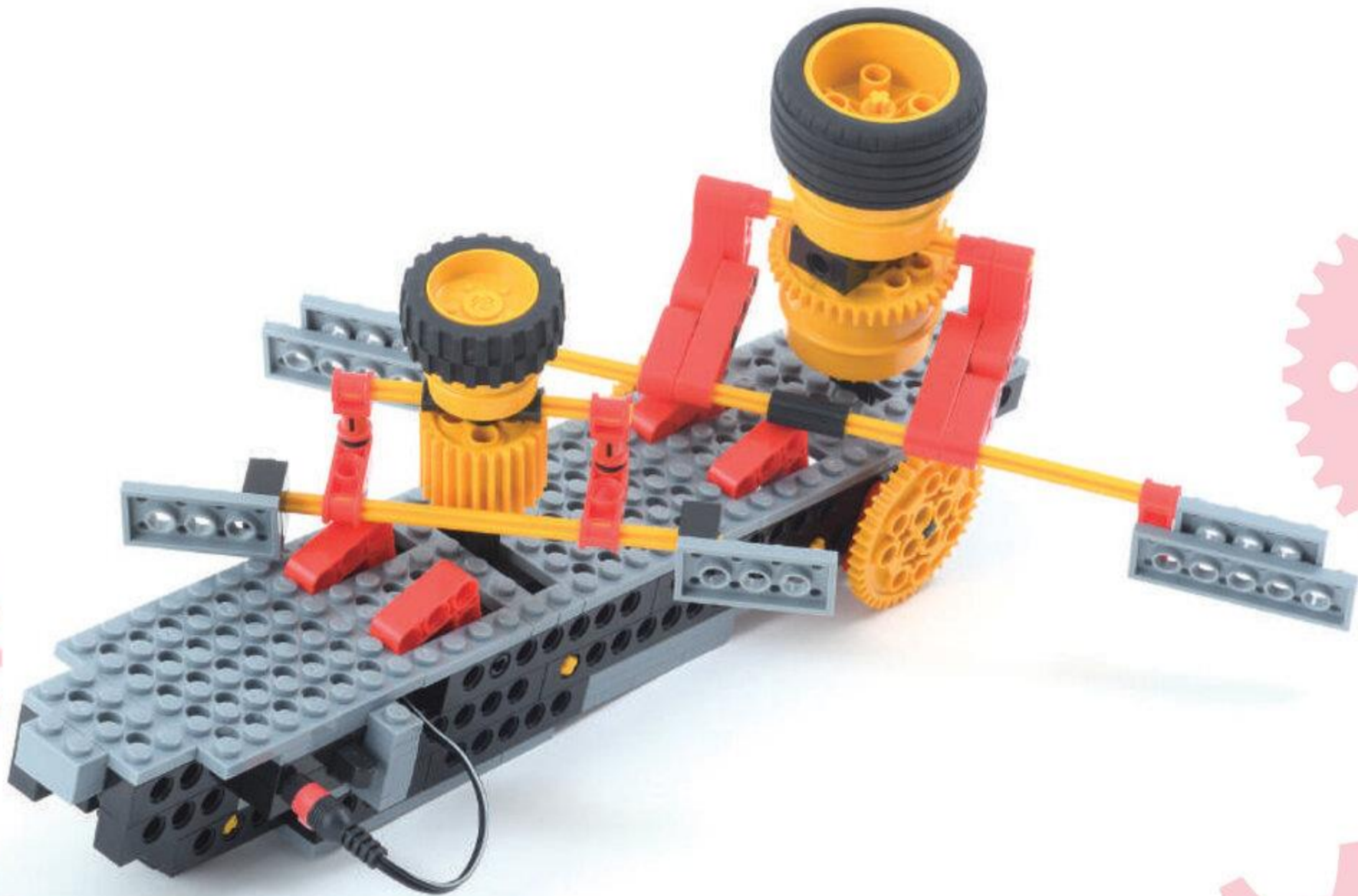

★だい2かい

2023 ねん

9 がつ

にち

なまえ

もくじ

だい 2 かい

きょうの よてい	55	2ふん
くみたて		
1. おとな	56～65	80ふん
2. こども	66～72	
3. おとなと こどもの とりつけ	73	
<small>ろぼっと</small> ロボットを うごかそう	74	
いぬをつくろう	75～83	
じゆうに かいぞう してみよう	84	
まちがい さがし	85	3ふん
かたづけ		5ふん

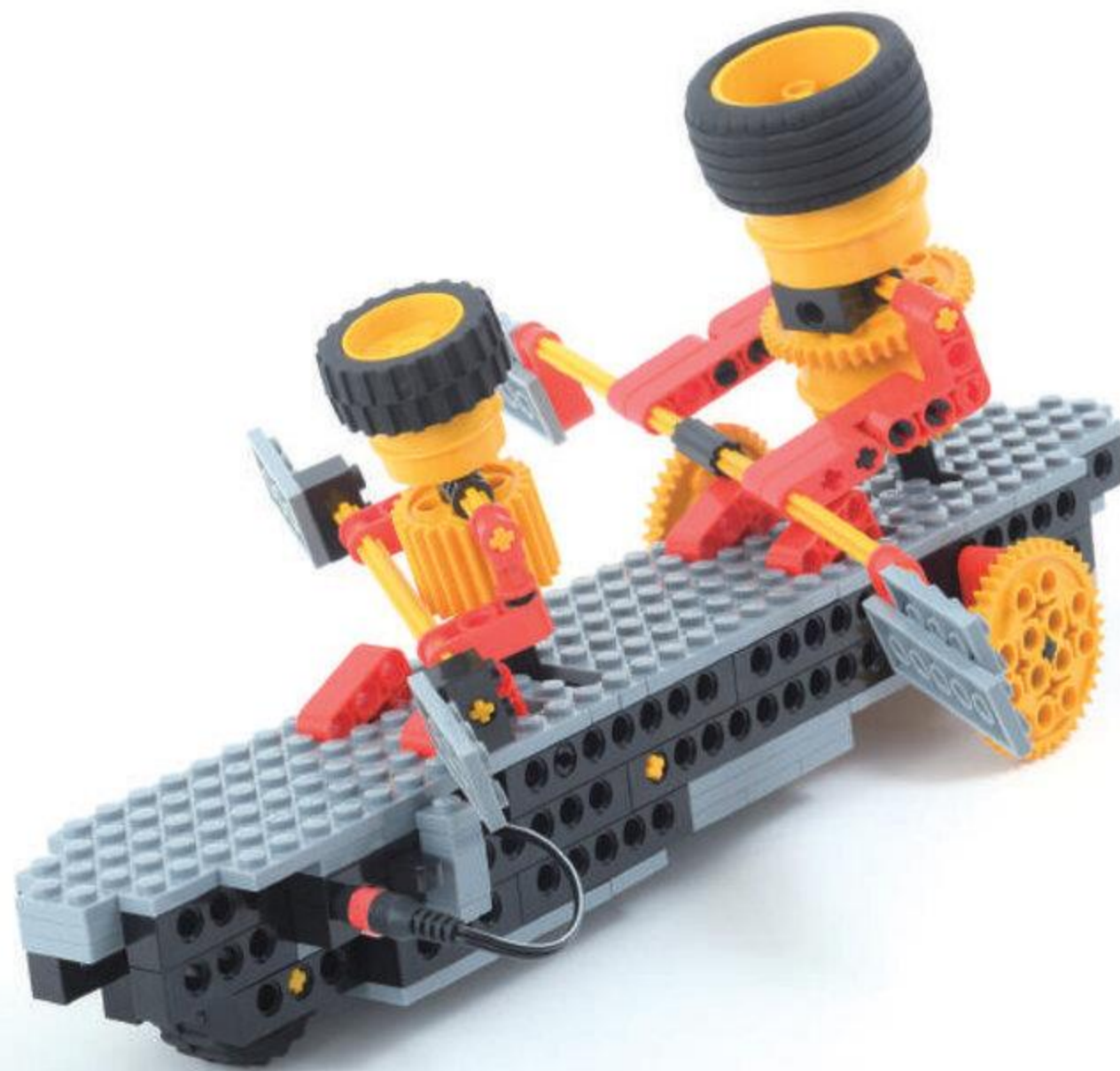

こんかいは ふねに のる  
ひとをつくるよ!

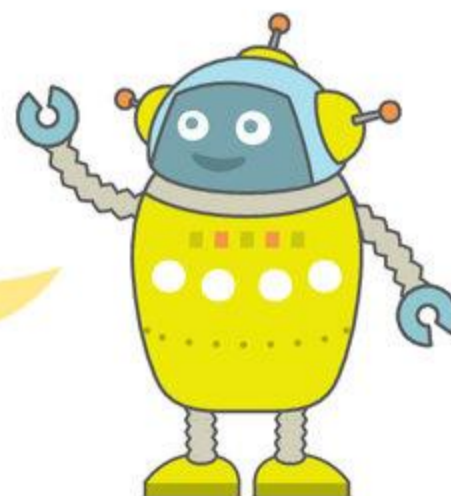

# きょうの よてい

めやす 2 ふん

このじゅんばんでつくるよ!

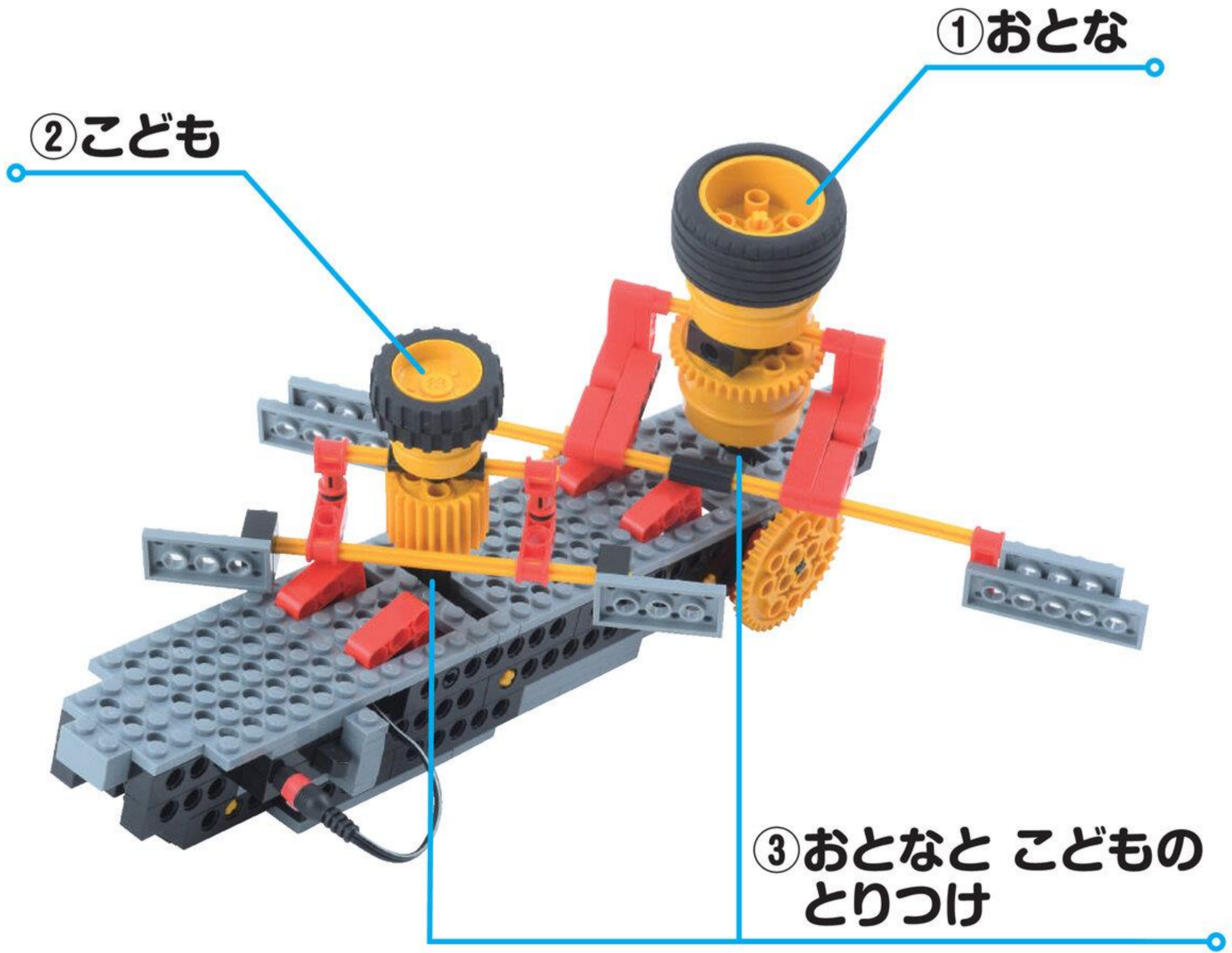

①おとな

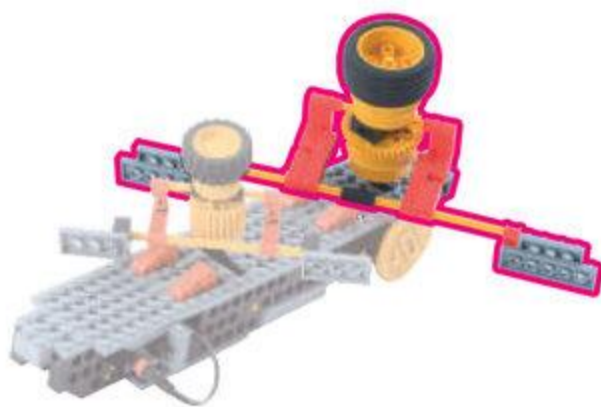

②こども



③おとなとこどものとりつけ

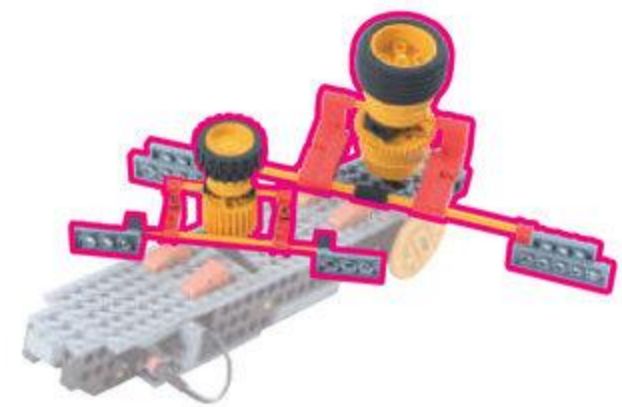

1 おとな

めやす 15 ぶん

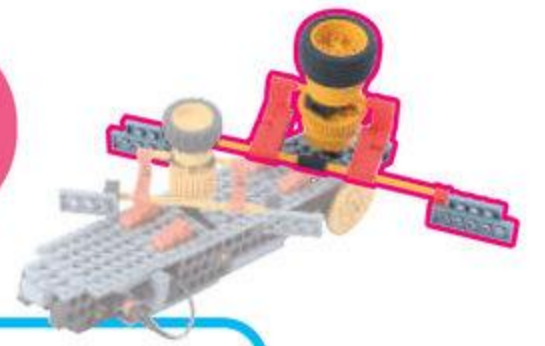

えろっど  
Lロッド 2こ



へぐえす  
ペグS 4こ



1

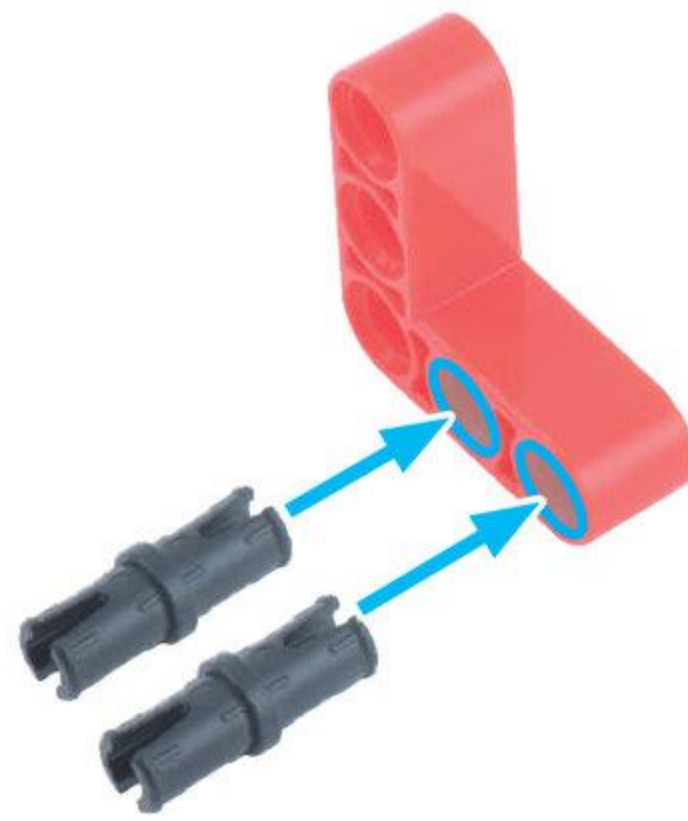
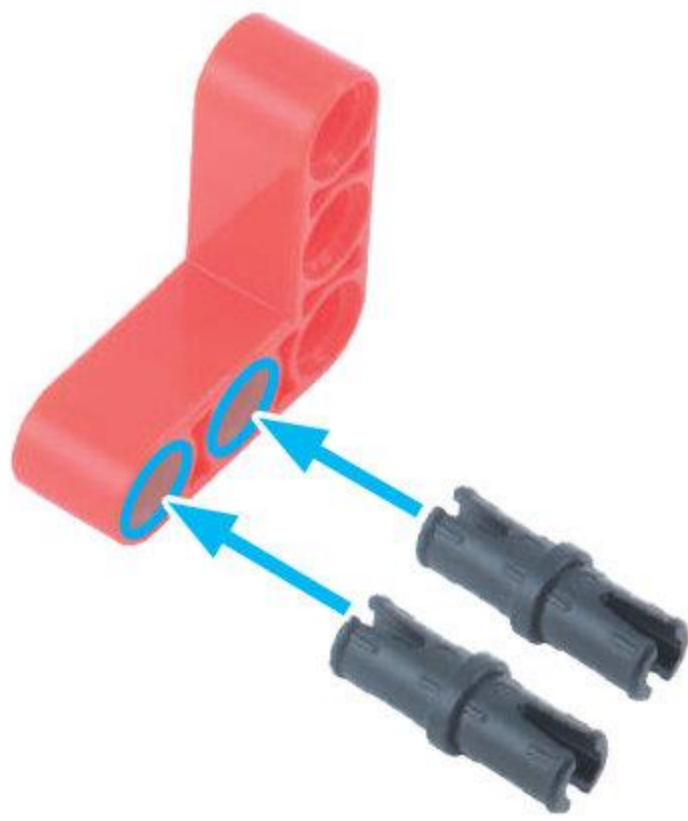



ろっどごあな  
ロッド5アナ 2こ



くらんく  
クランク 2こ

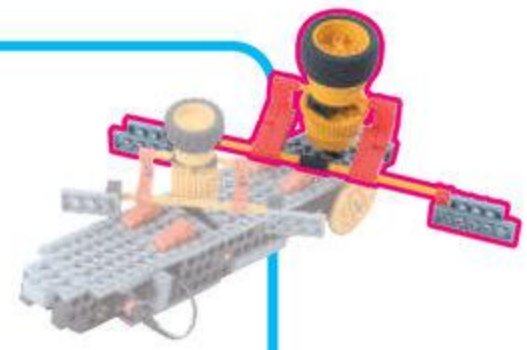

2

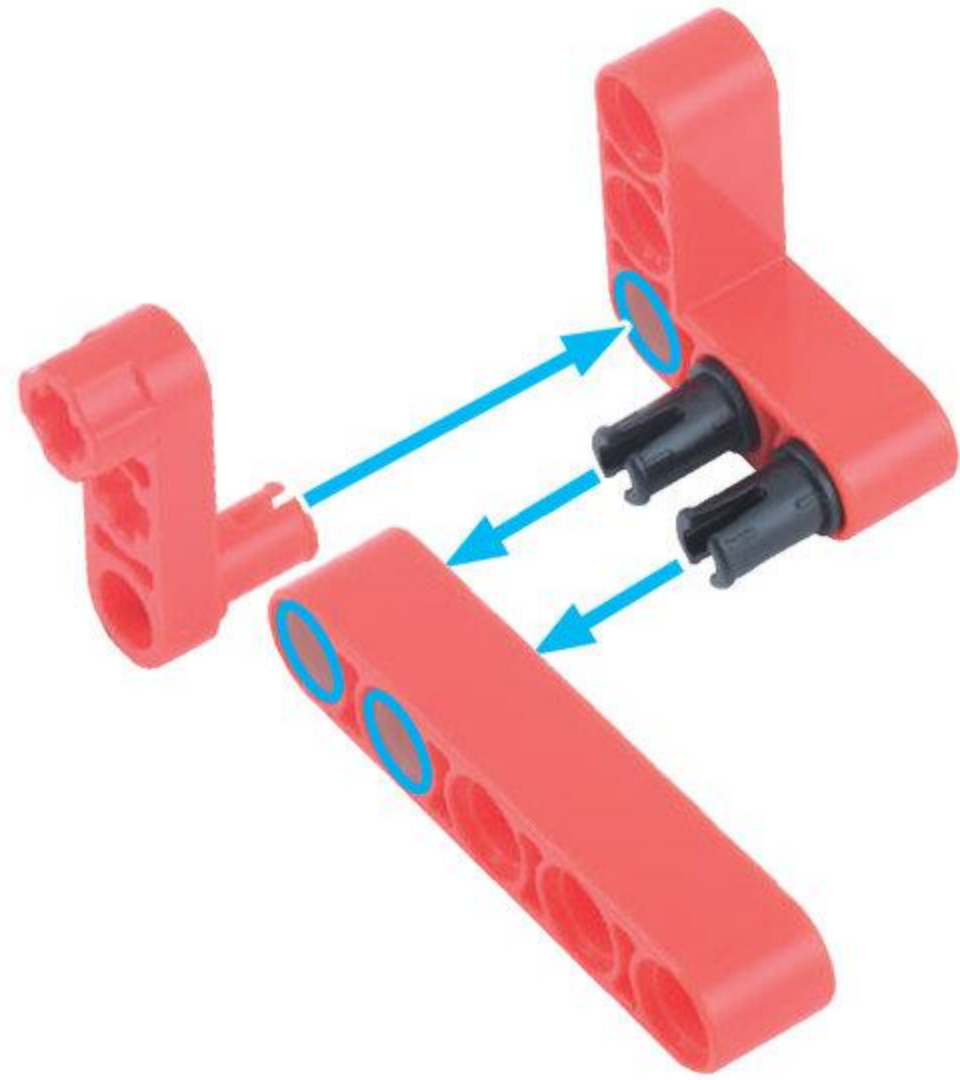
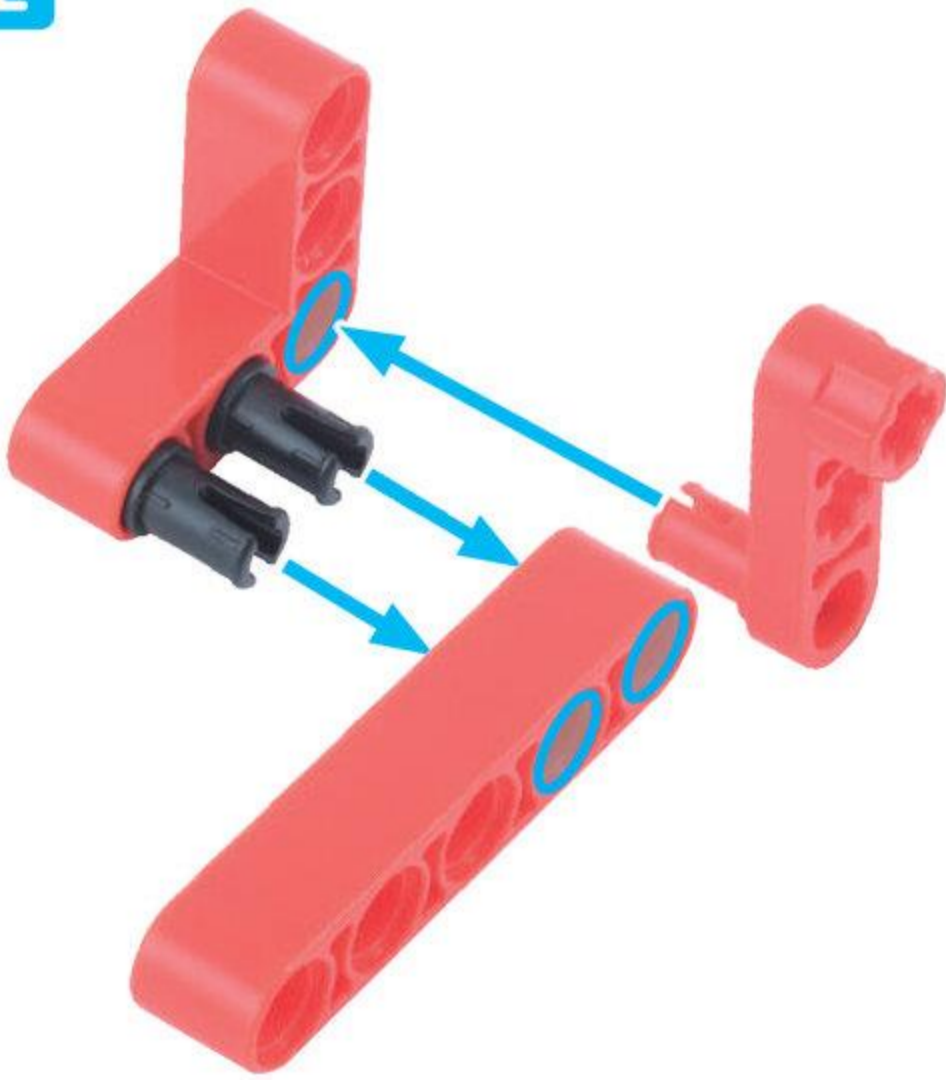

ろっどさんあな 2こ  
ロッド3アナ



しゃふとペグ 2こ  
シャフトペグ

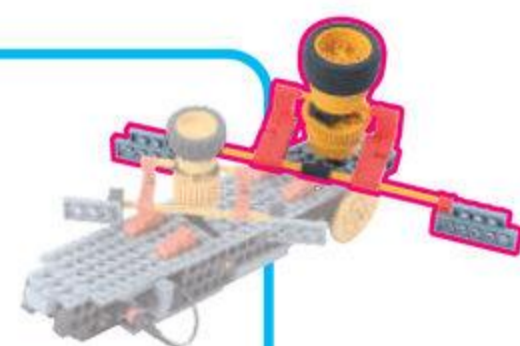

3

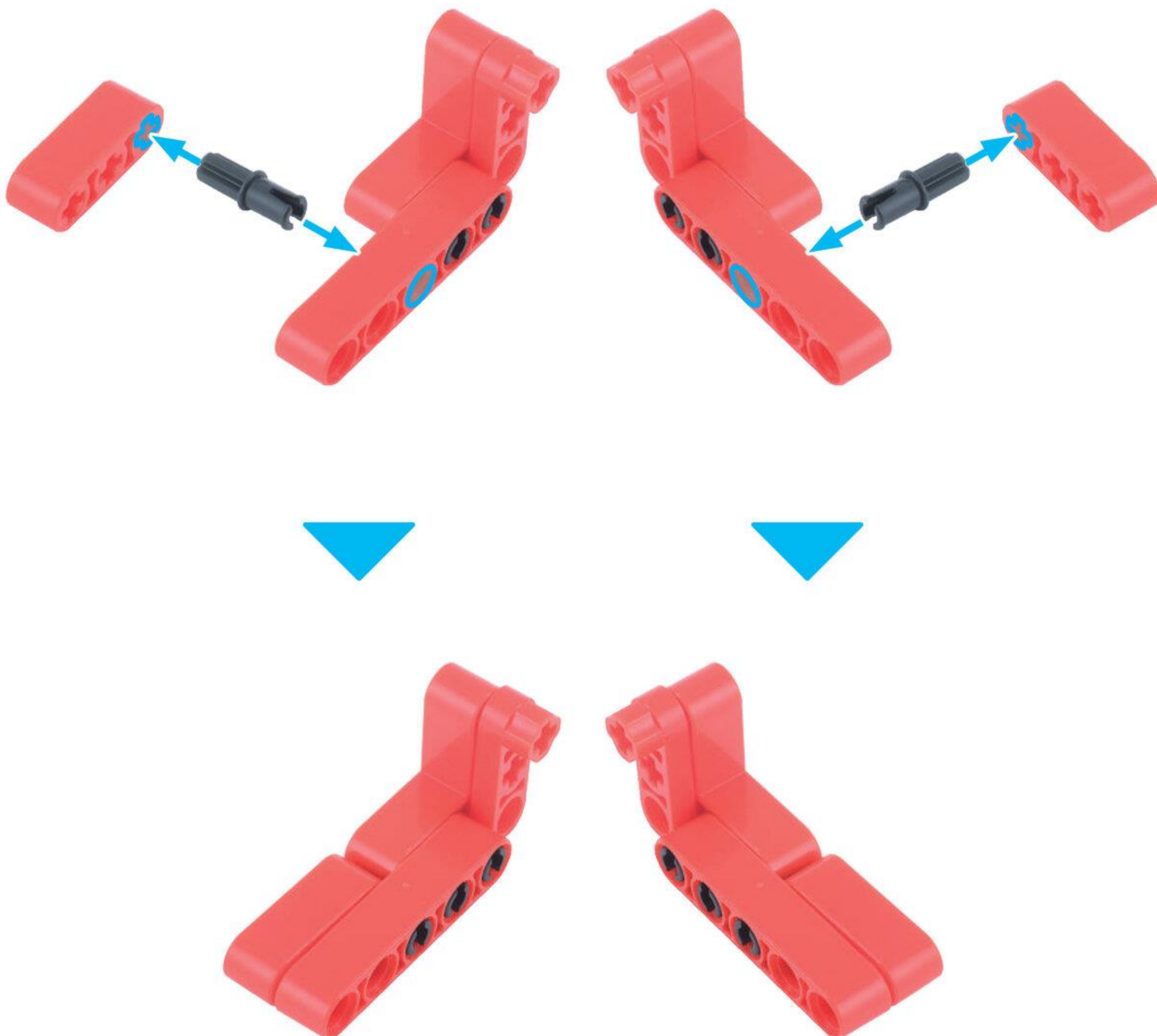

あなしゃふとじょいんと  
アナシャフトジョイント 1こ



しゃふとよんぼち  
シャフト 4 ポチ 2こ

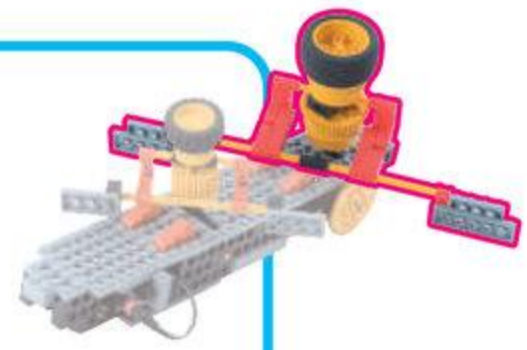

ながさに  
ちゅうい

4

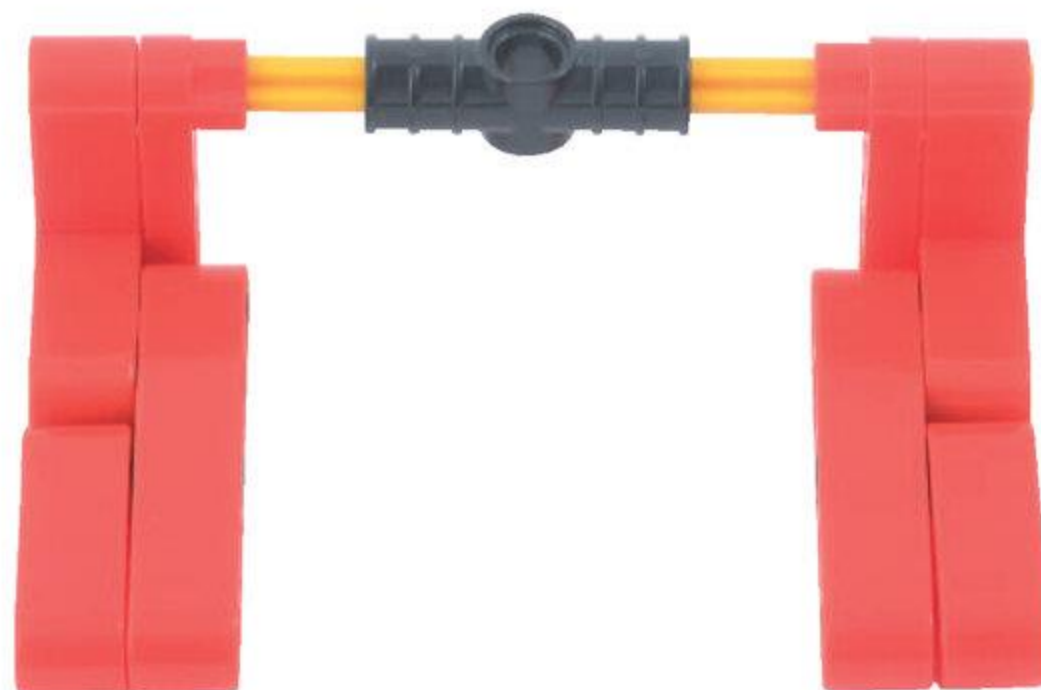

シャフトジョイント 1こ



シャフト 10ポチ 2こ

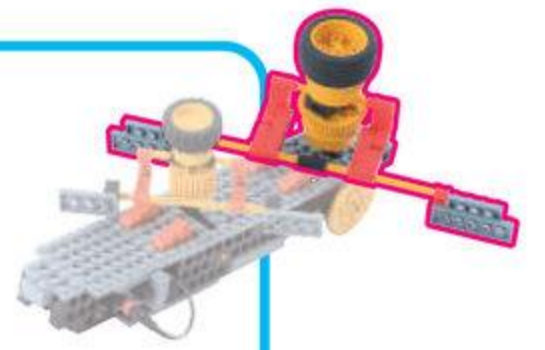

5

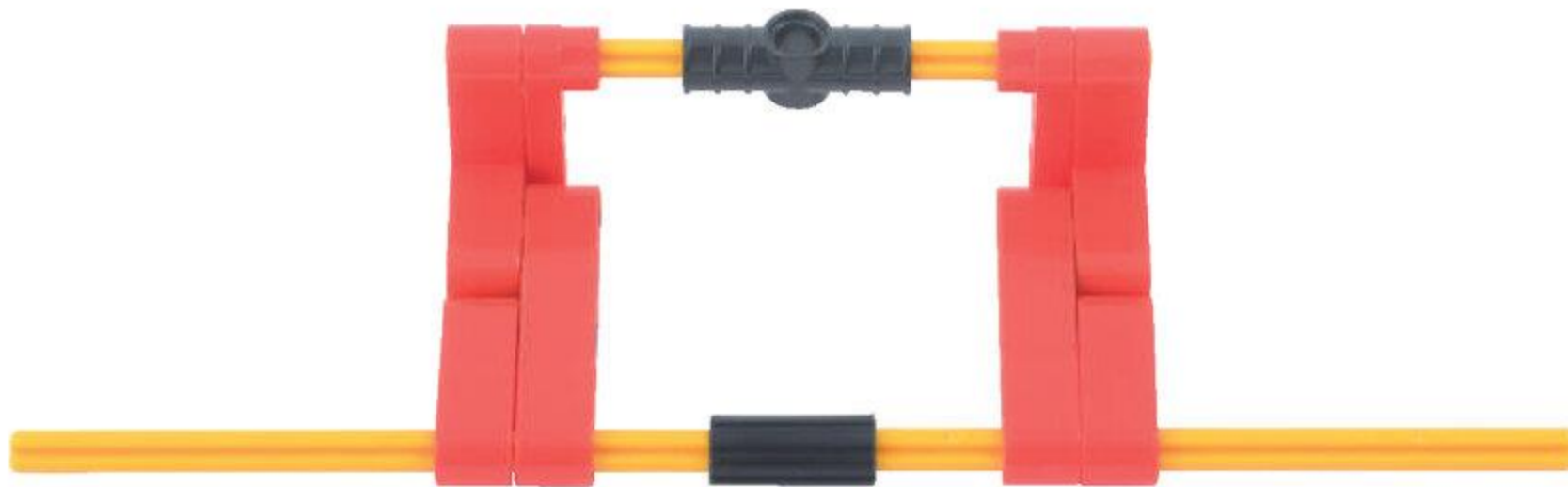
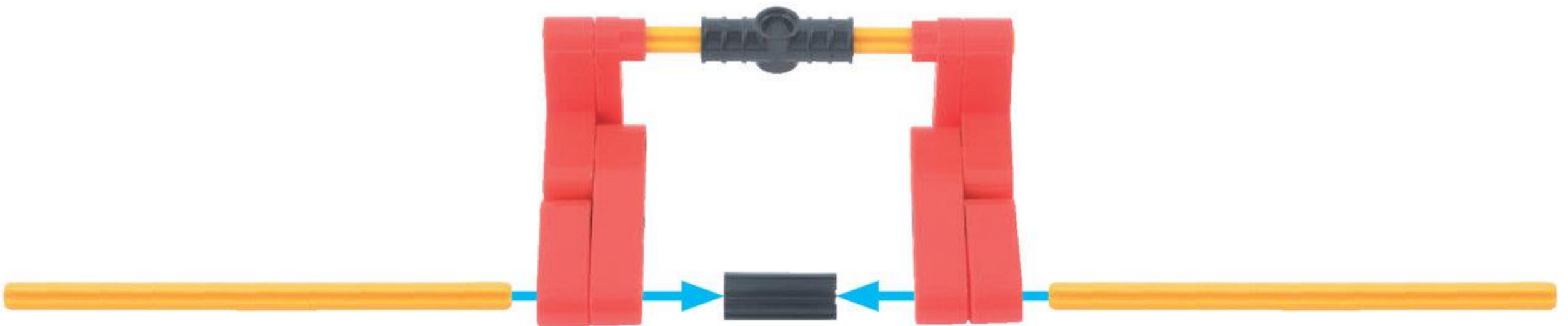

たいやえ  
タイヤ L 1こ

ぎあえ  
ギア L 1こ

ぎあえむ  
ギア M うす 1こ

しゃふとじゅう ぼち  
シャフト 10 ポチ 1こ

6

ごむ  
ゴムを  
はずす

ぼち  
5 ポチぶん

ごむ  
ゴムをはずすのは  
せんせいに  
やってもらおう

びいむにほち  
ビーム2ポチ 1こ

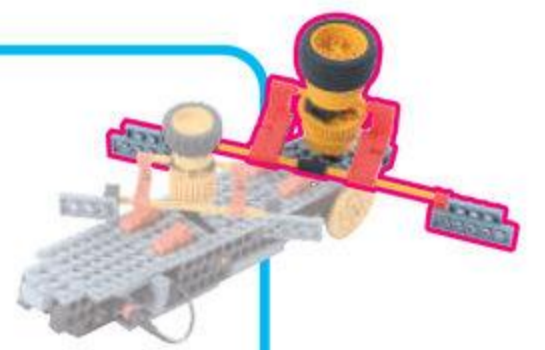

7

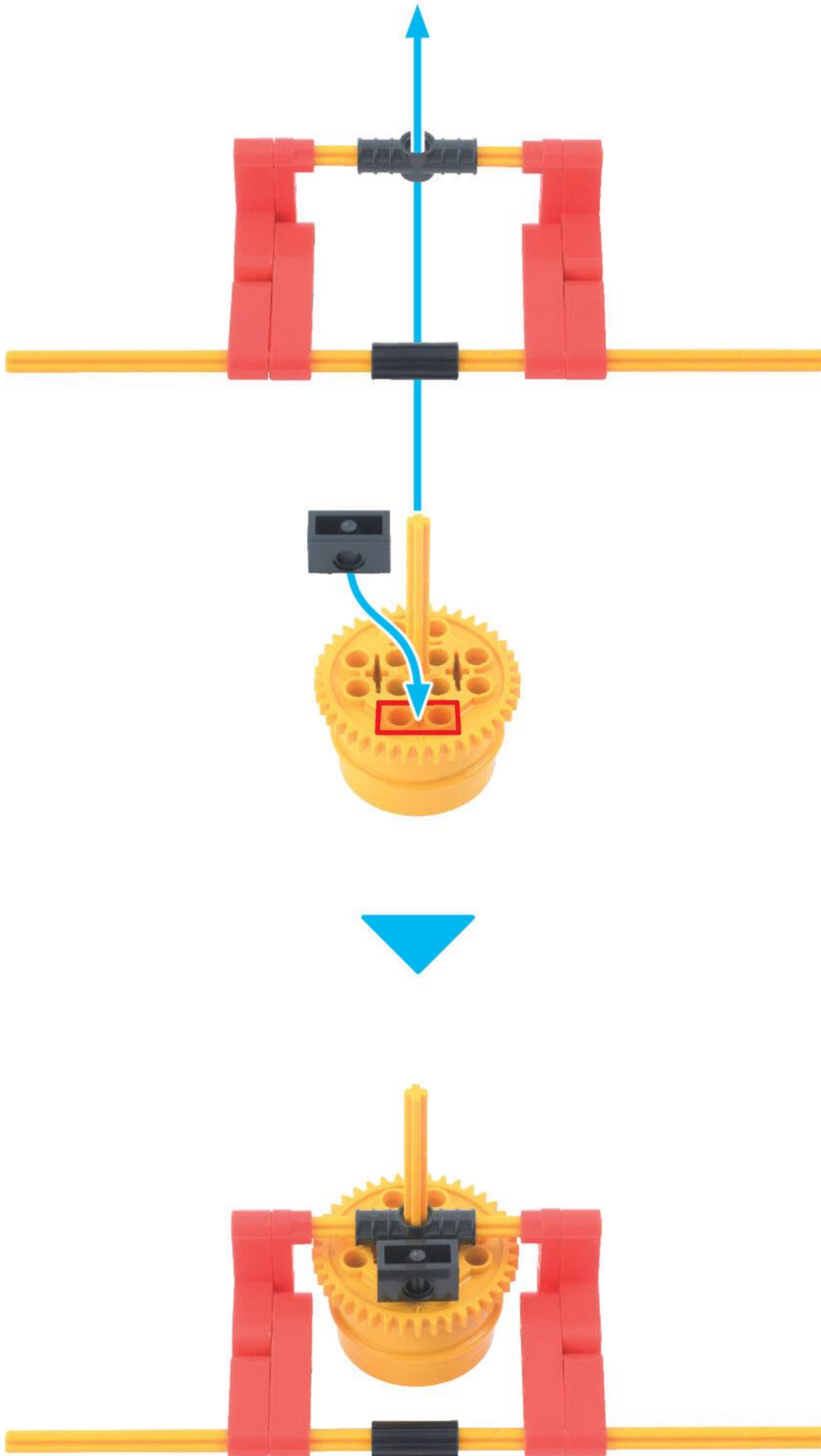

タイヤ 2こ  
えり

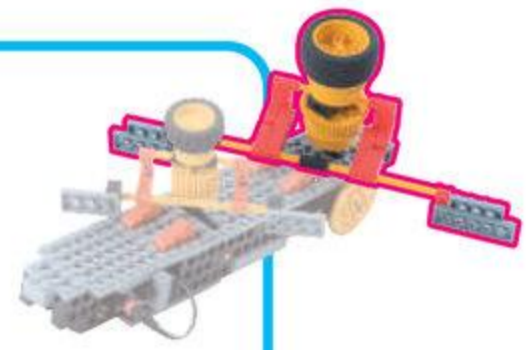

8 ゴムをはずす



タイヤは  
1こだよ  
ゴムをはずす

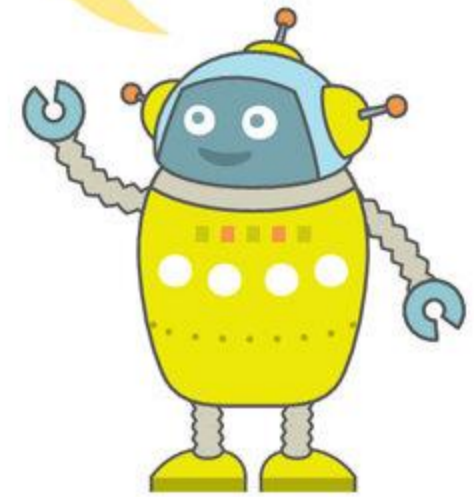

くろすじょいんと  
クロスジョイント **2**こ



ふとぶれえとよんぼち  
太プレート 4 ポチ **2**こ



ふとぶれえとろくぼち  
太プレート 6 ポチ **2**こ

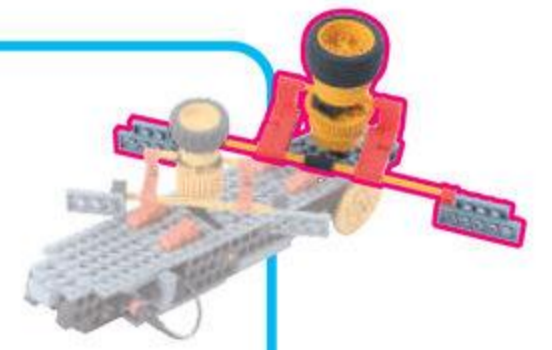

9

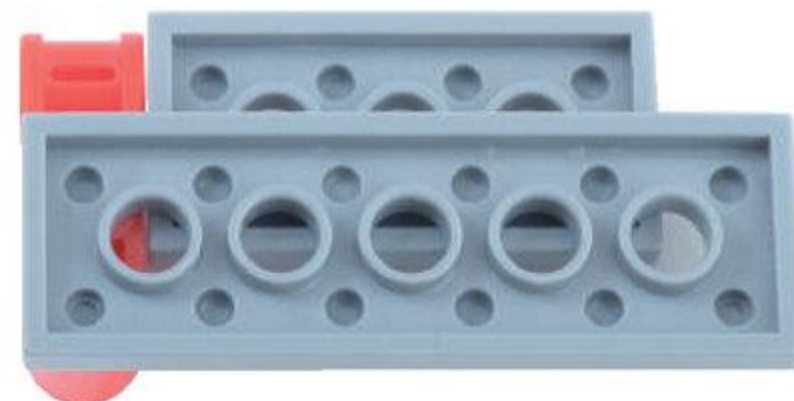
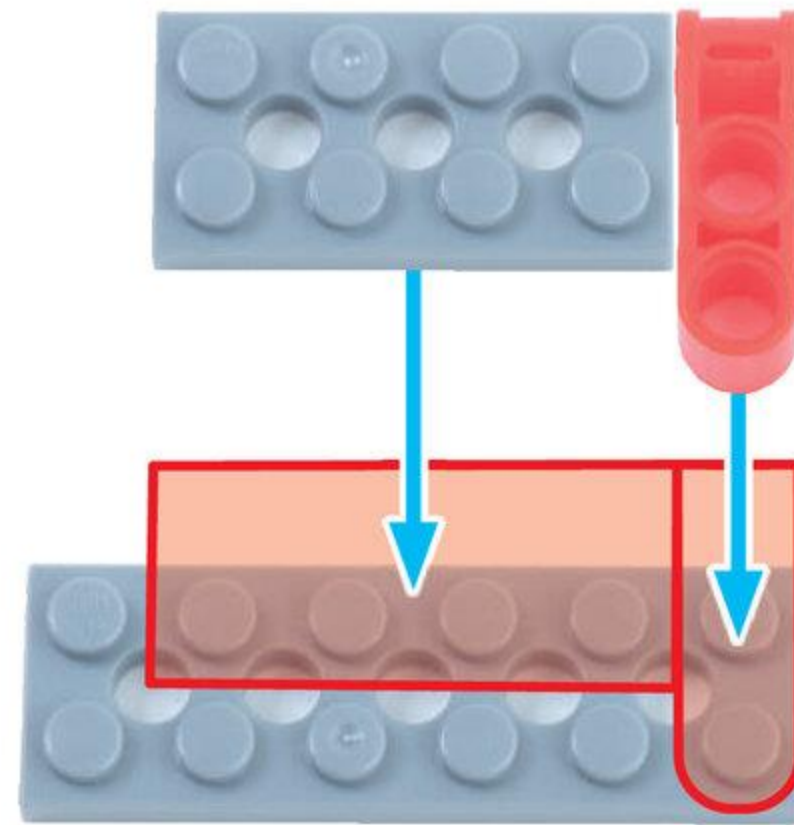
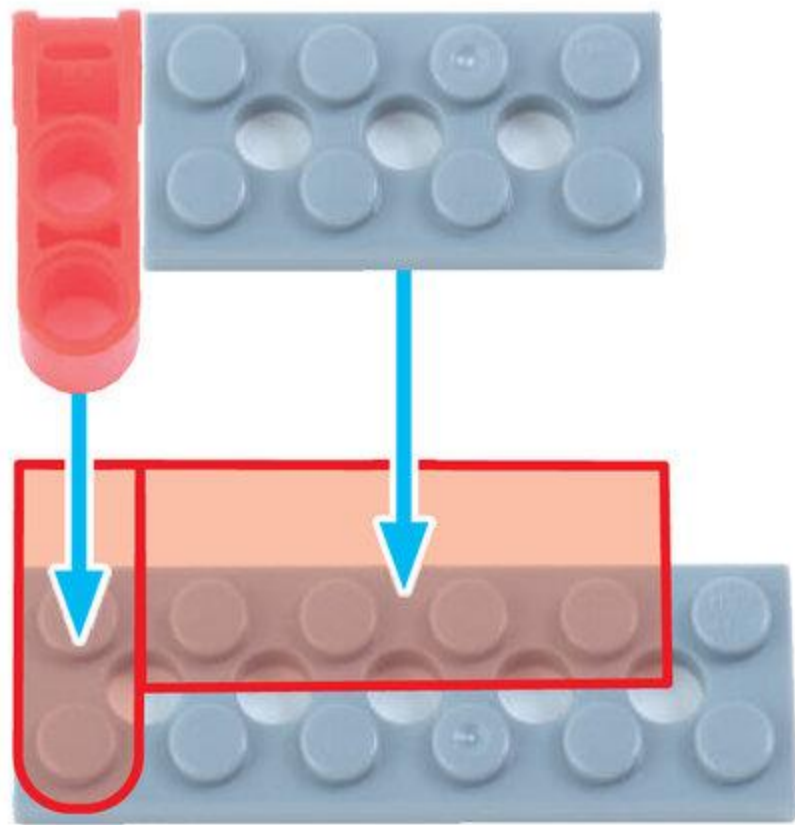



10

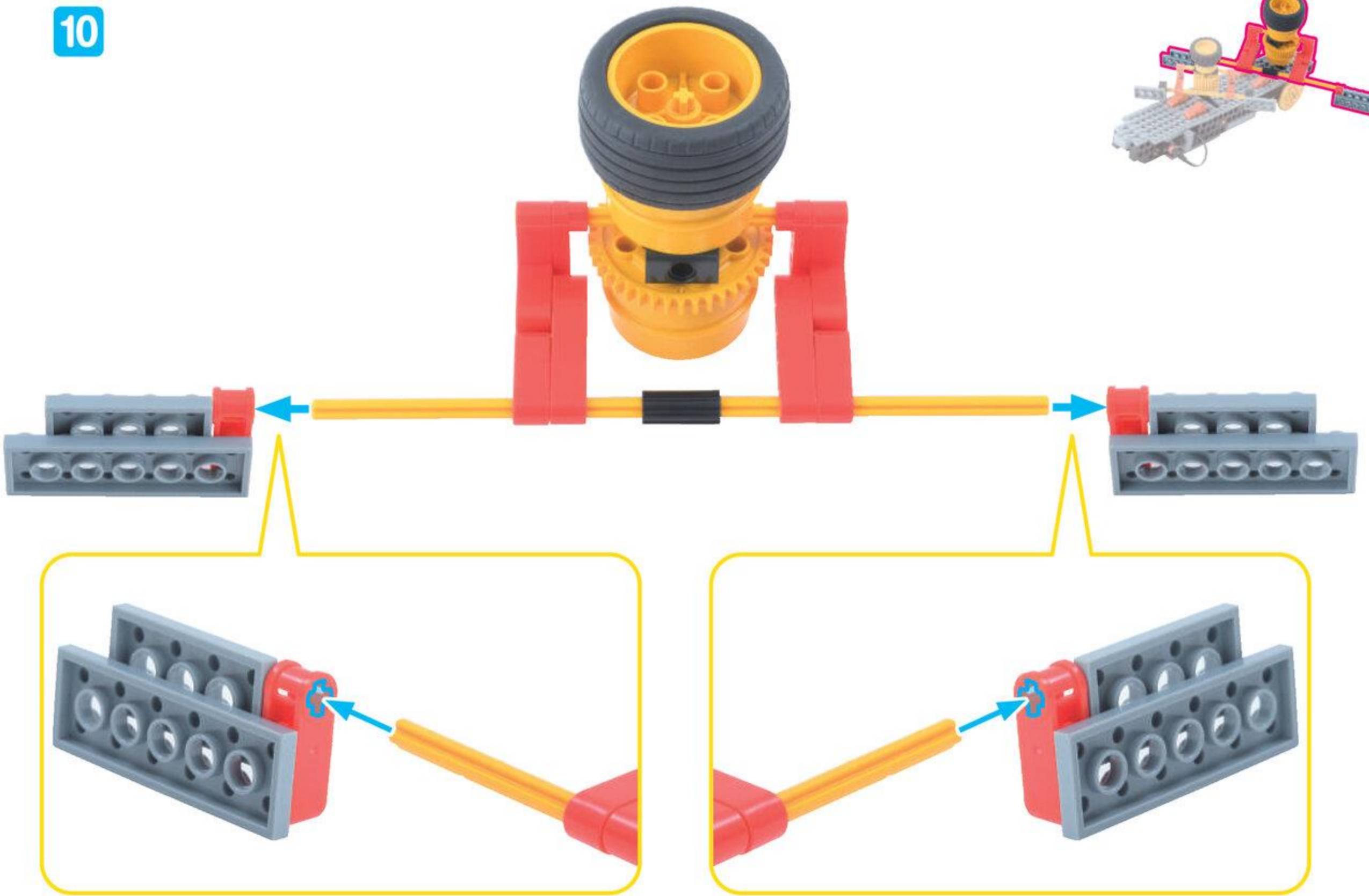
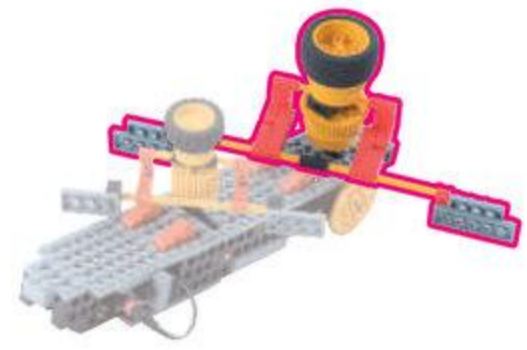

おとなが  
かんせい!

やったね!

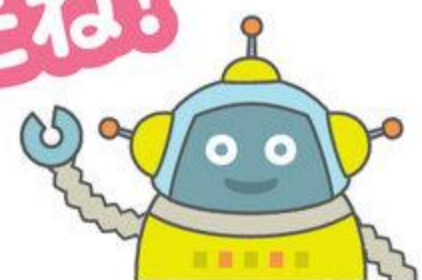

2 こども

めやす 15 ぶん

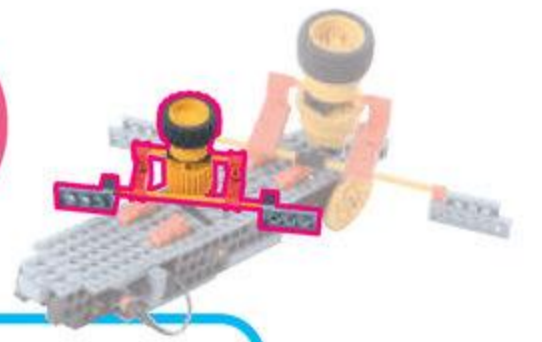

くるすじょいんと  
クロスジョイント 2こ



しゃふとペグ  
シャフトペグ 2こ



ていじょいんと  
T ジョイント 2こ



1



あなしゃふとじょいんと  
アナシャフトジョイント 1こ



しゃふとさんぽち  
シャフト 3 ポチ 2こ



ながさに  
ちゅうい

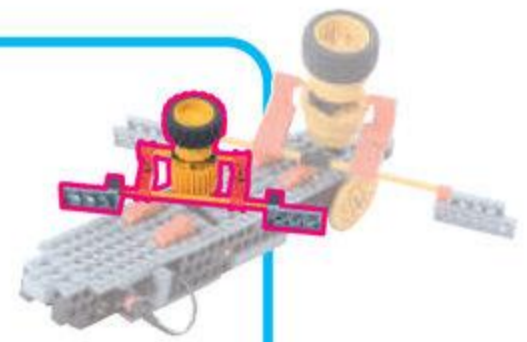

2



あな  
アナの むきに  
ちゅういしよう



しゃふとじゅうにぼち  
シャフト 12 ポチ 1こ



3

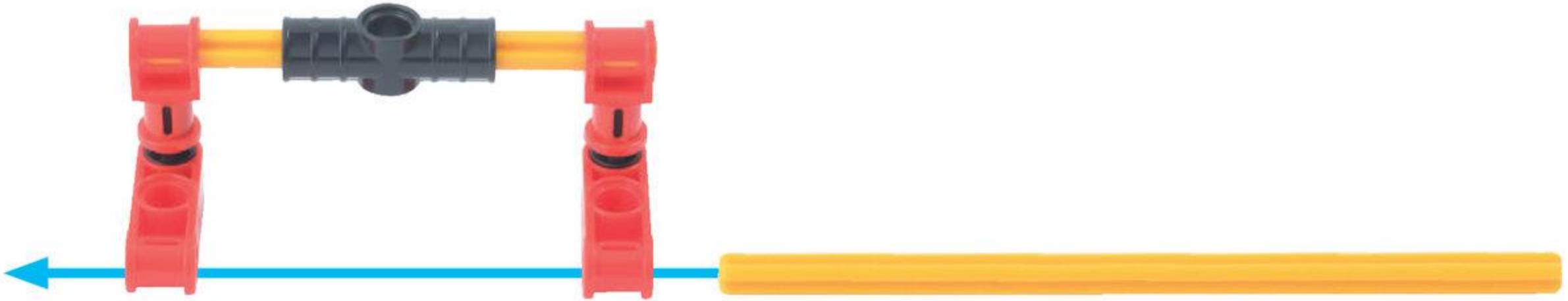

シャフトとほちポチ 1こ



ギア Mうす 5こ

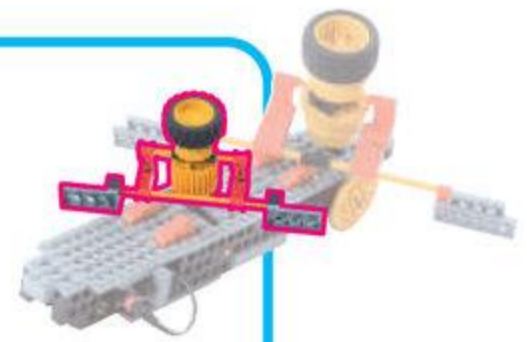
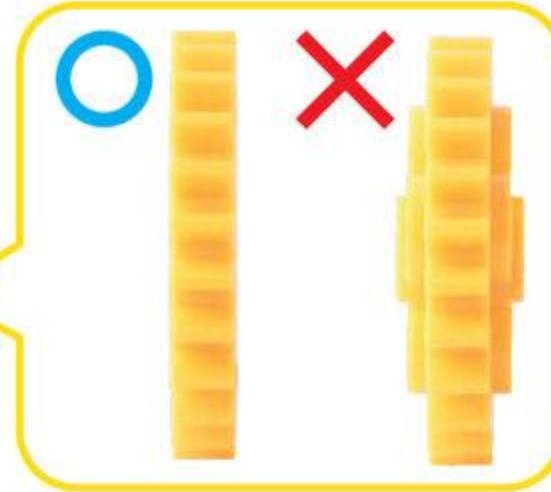
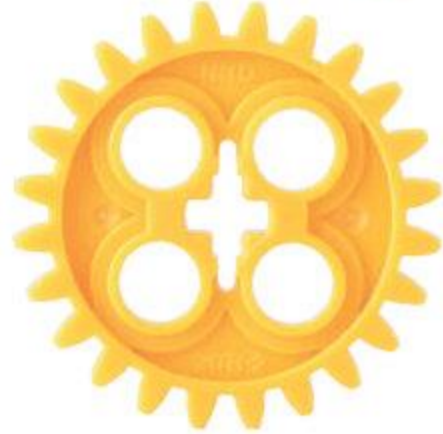

4

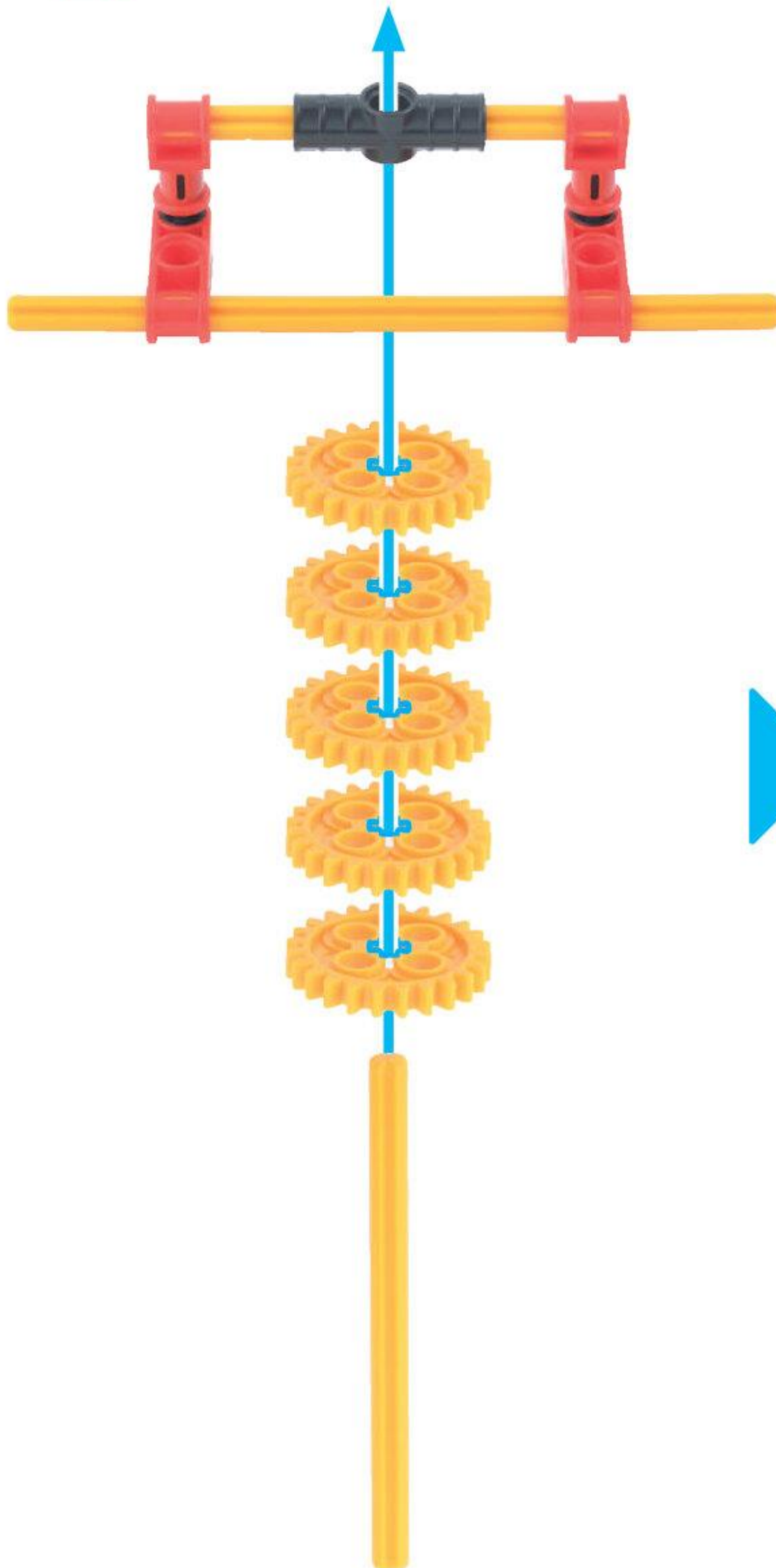

タイヤ 2こ  
えす S

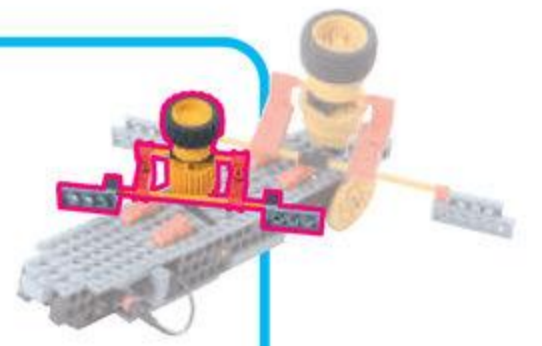

5 ゴムをはずす



タイヤは  
1こだよ  
ゴムをはずす

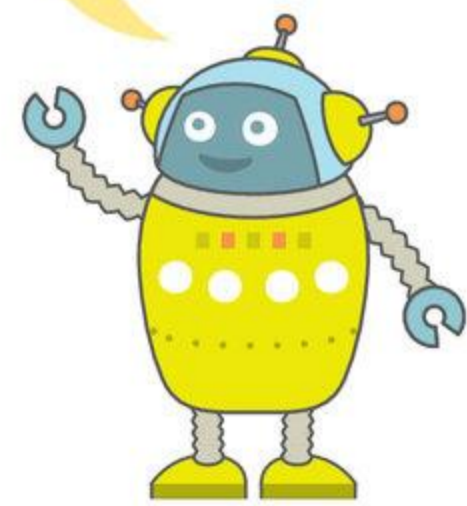

しゃふとびいむにほち  
シャフトビーム 2 ポチ **2** こ



ふとぶれえとよんほち  
太プレート 4 ポチ **2** こ



6

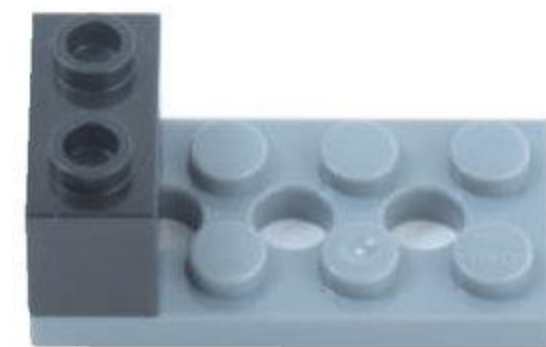
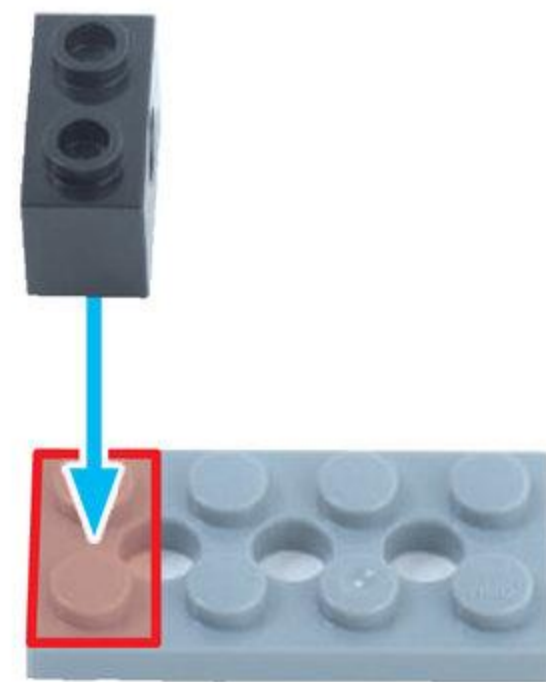
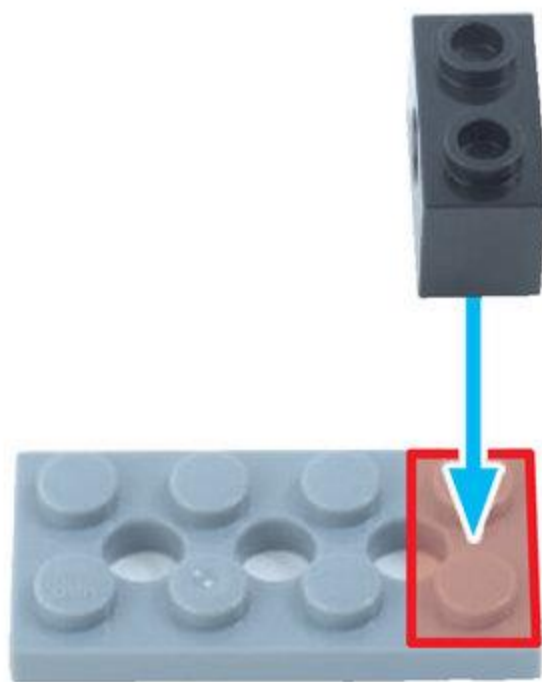

7

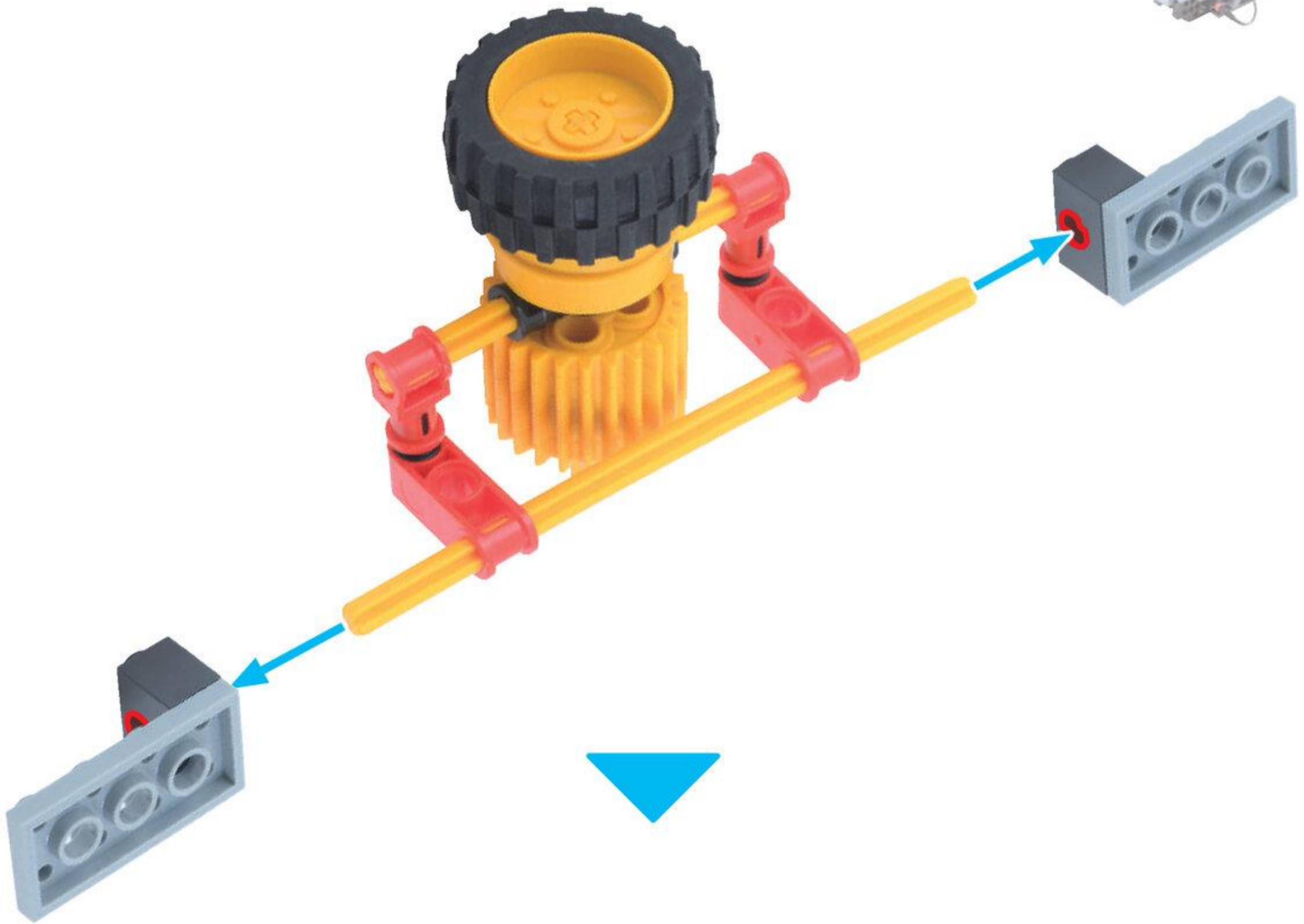
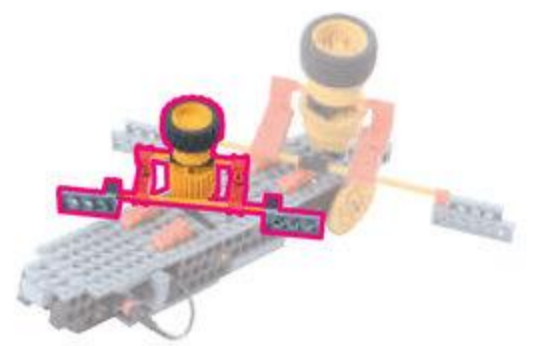

こどもが  
かんせい!

やったね!

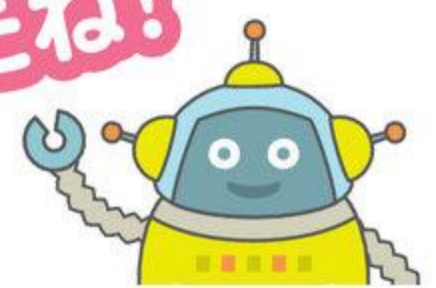



3

おとなとこどものとりつけ めやす 5 ふん



1

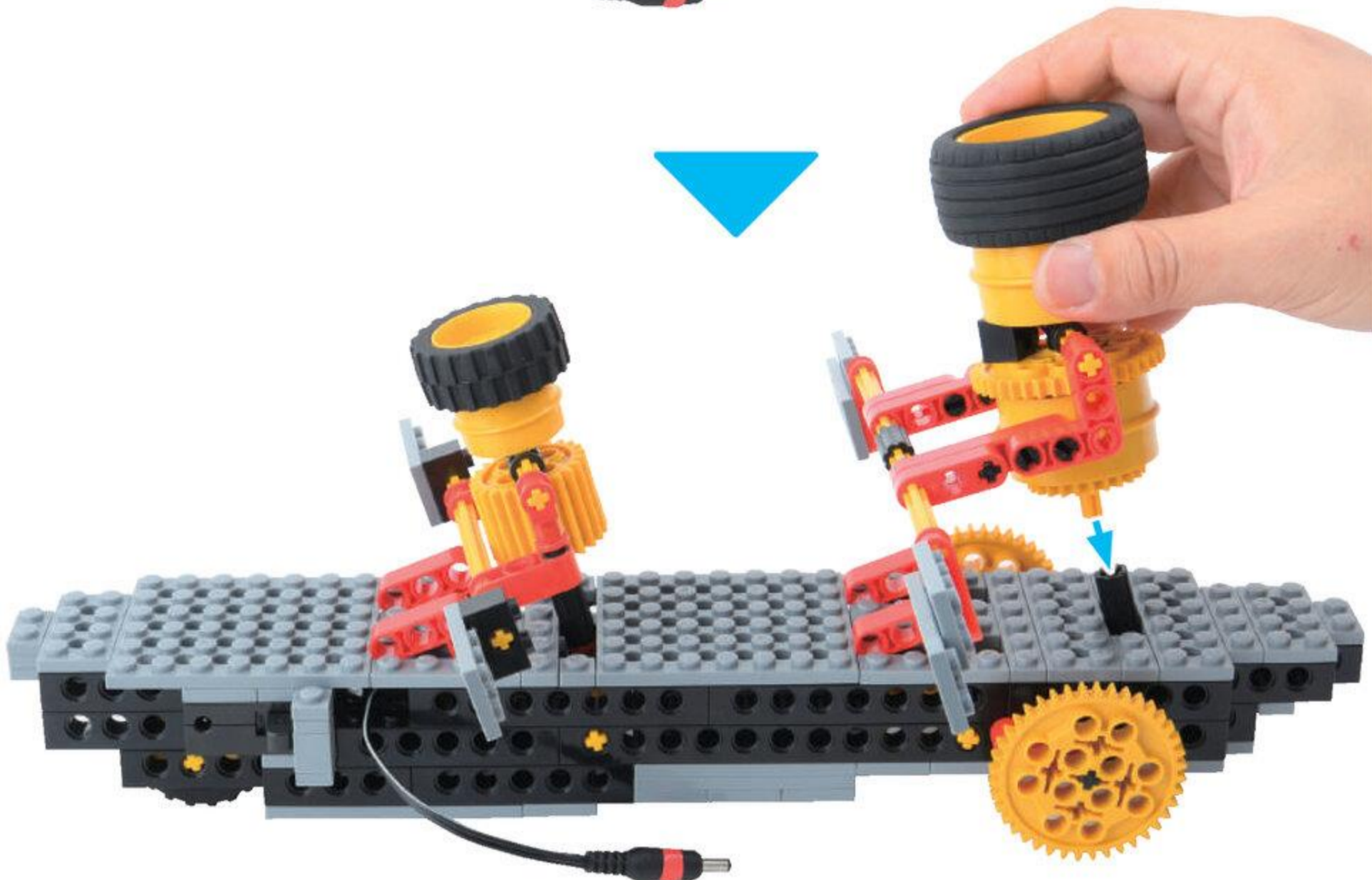
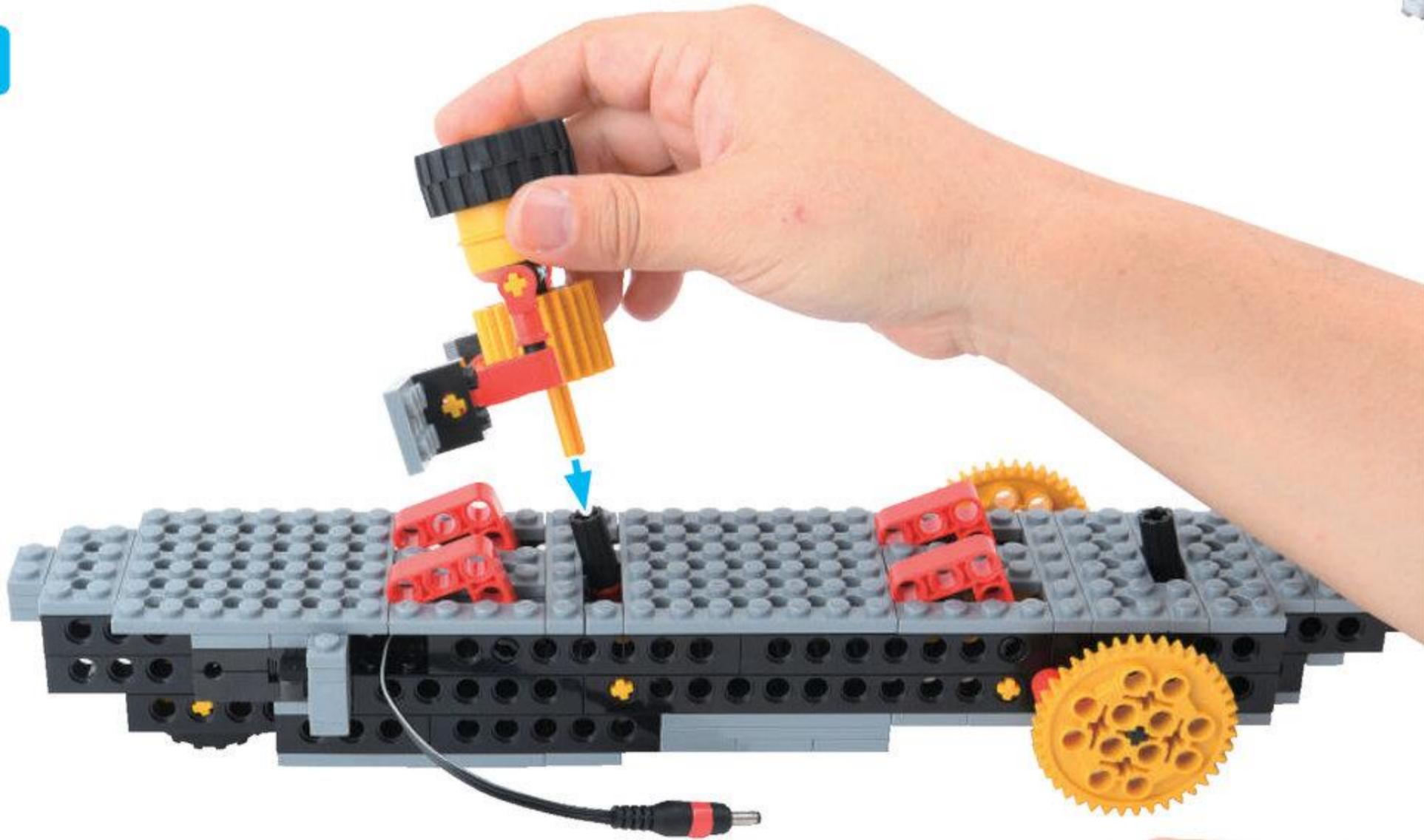

これで  
かんせい!

よくできました!

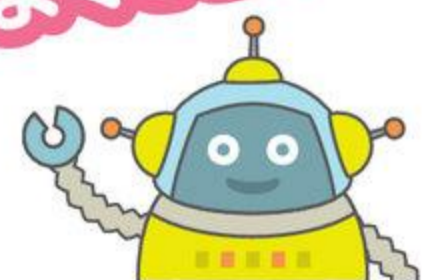

# ろぼっと ロボットを うごかそう

めやす 20 ぶん



ぶらぐ プラグを さしこんだら  
やじるしの むきに スイッチを いれよう

おおる  
オールを こいで  
すすんだかな

# いぬをつくらう

めやす 15 ぶん

びいむよんぼち  
ビーム4ポチ 2こ



ぺぐす  
ペグS 1こ



びにおんぎあ  
ピニオンギアうす 2こ



しゃふとよんぼち  
シャフト4ポチ 1こ



ながさに  
ちゅうい

1

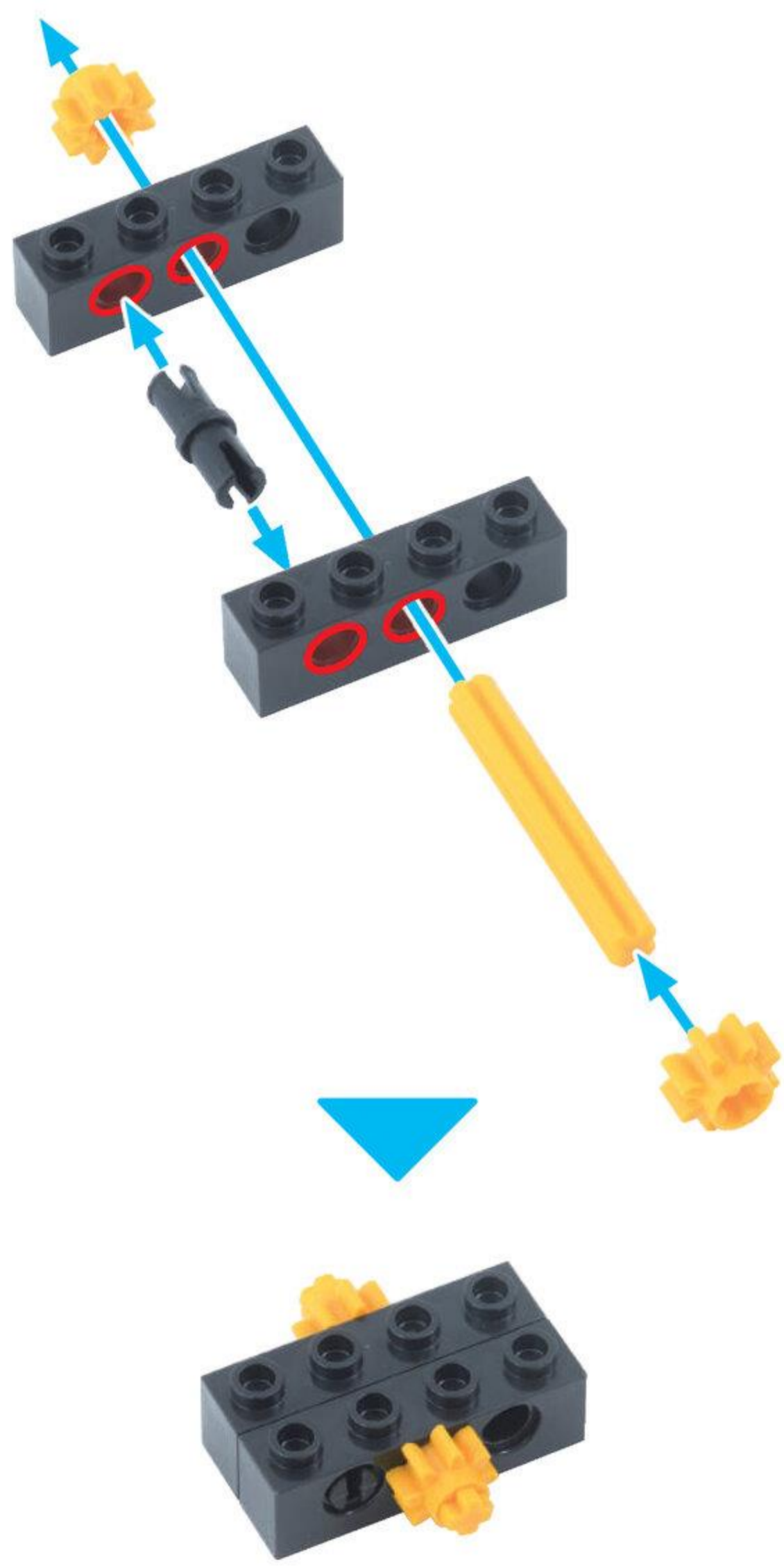

びいむにほち  
ビーム2ポチ 1こ

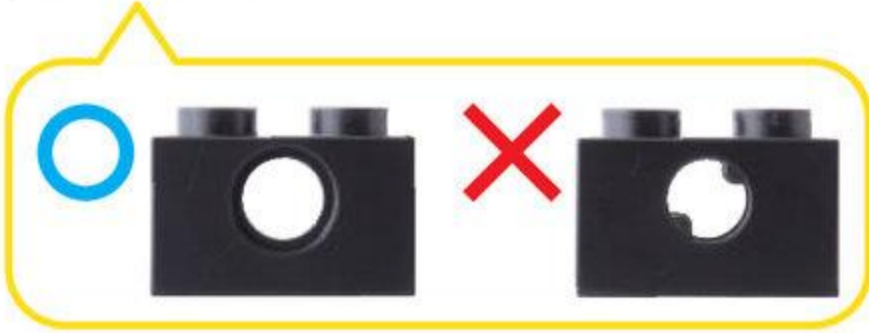

ほそぶれえとよんほち  
細プレート4ポチ 2こ



びいむいちほち  
ビーム1ポチ 2こ



2

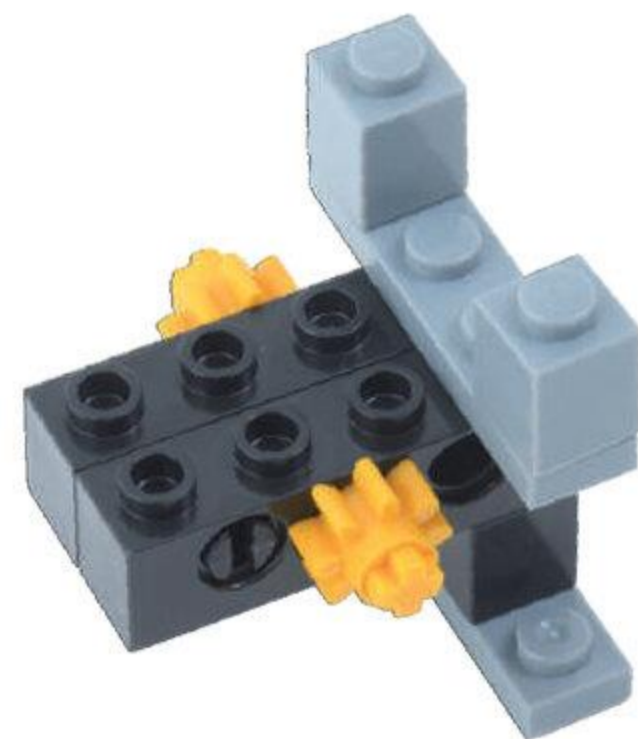
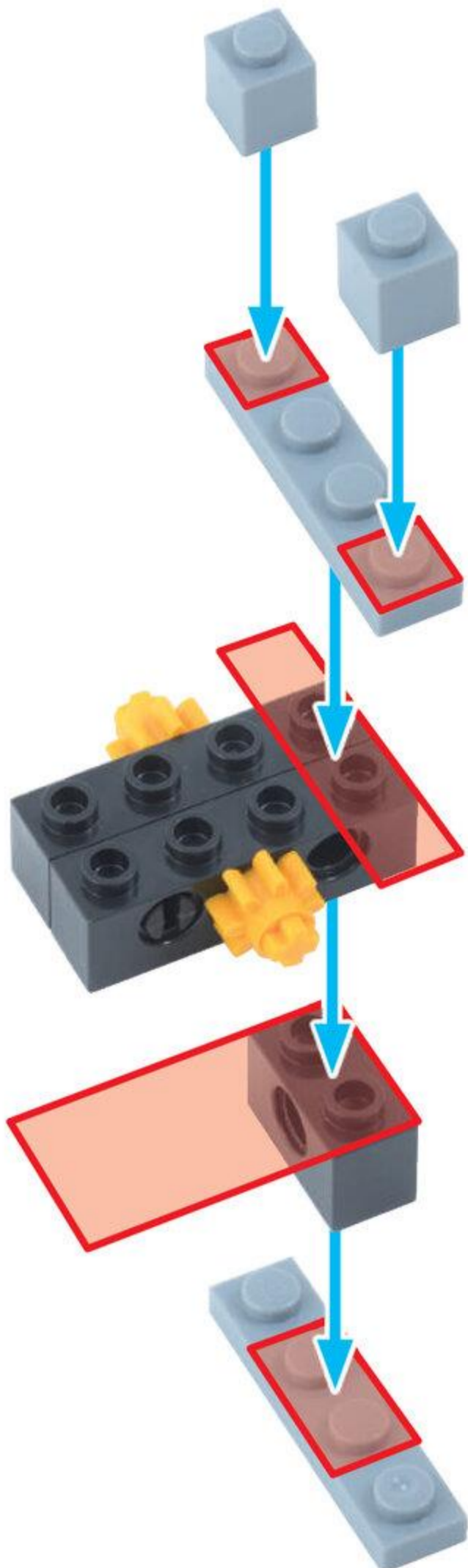

ろっど 3 あな 1 こ  
ロッド3アナ 1こ



しゃふと 3 さん ぽち 2 こ  
シャフト3ポチ 2こ



ながさに  
ちゅうい

てい じょいんと  
T ジョイント 2 こ



くろ しゃふと 1.5 ぽち 2 こ  
黒シャフト 1.5ポチ 2こ



3

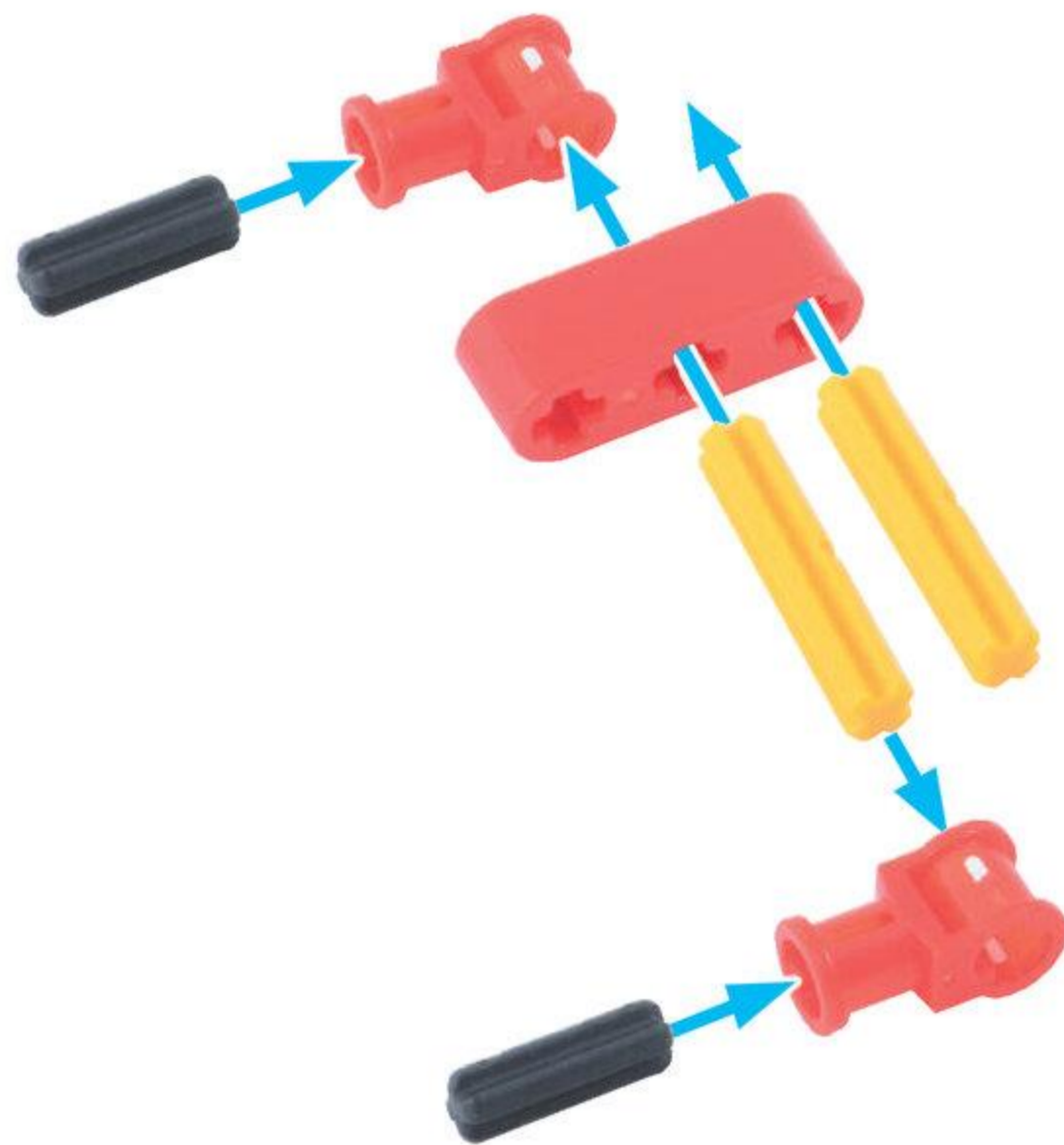

ろっど あな 5 アナ 1 こ



peg 3 こ



4



くろすじょいんと  
クロスジョイント 2こ



5

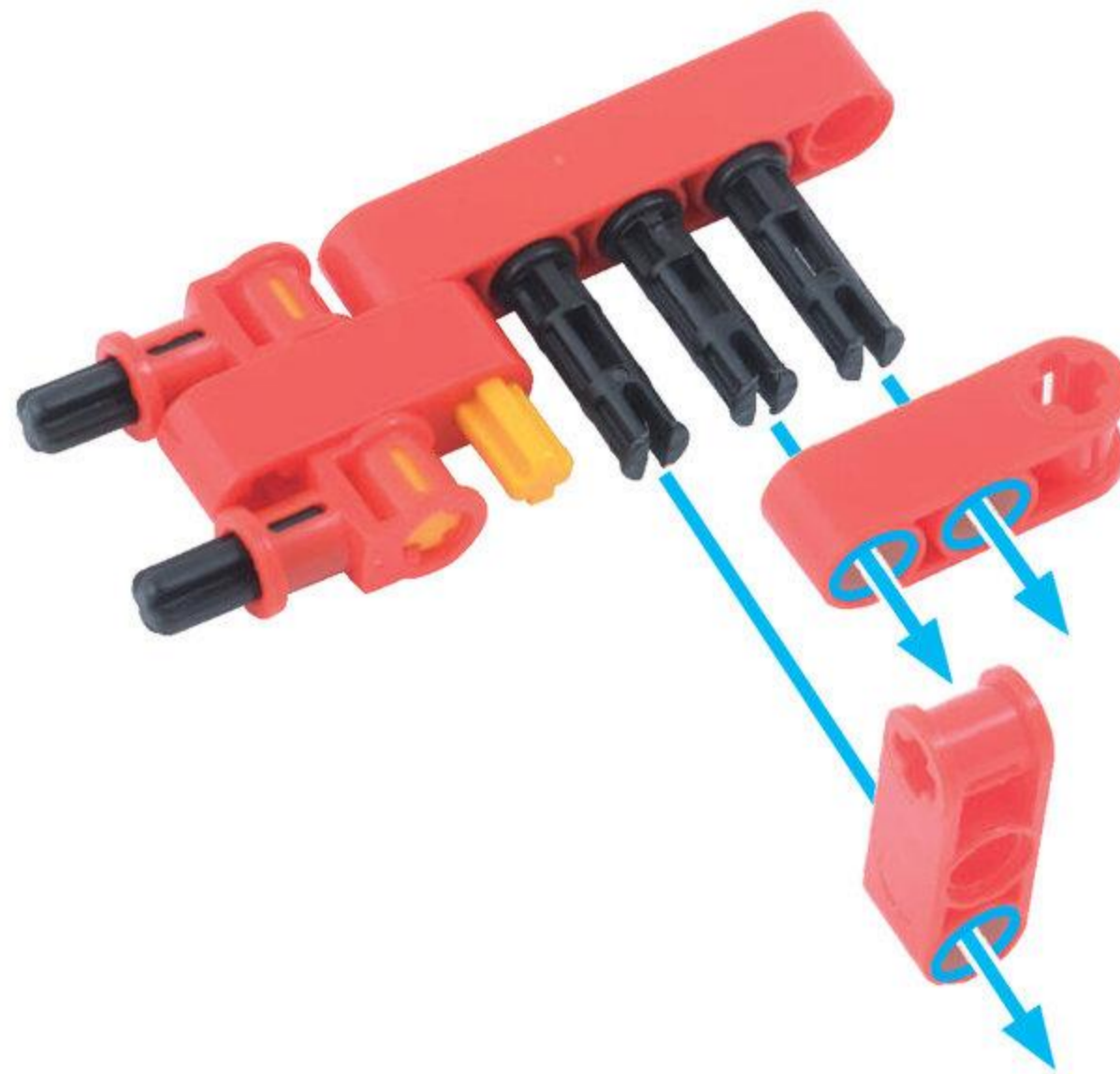

ろっど 5 あな 1こ



6

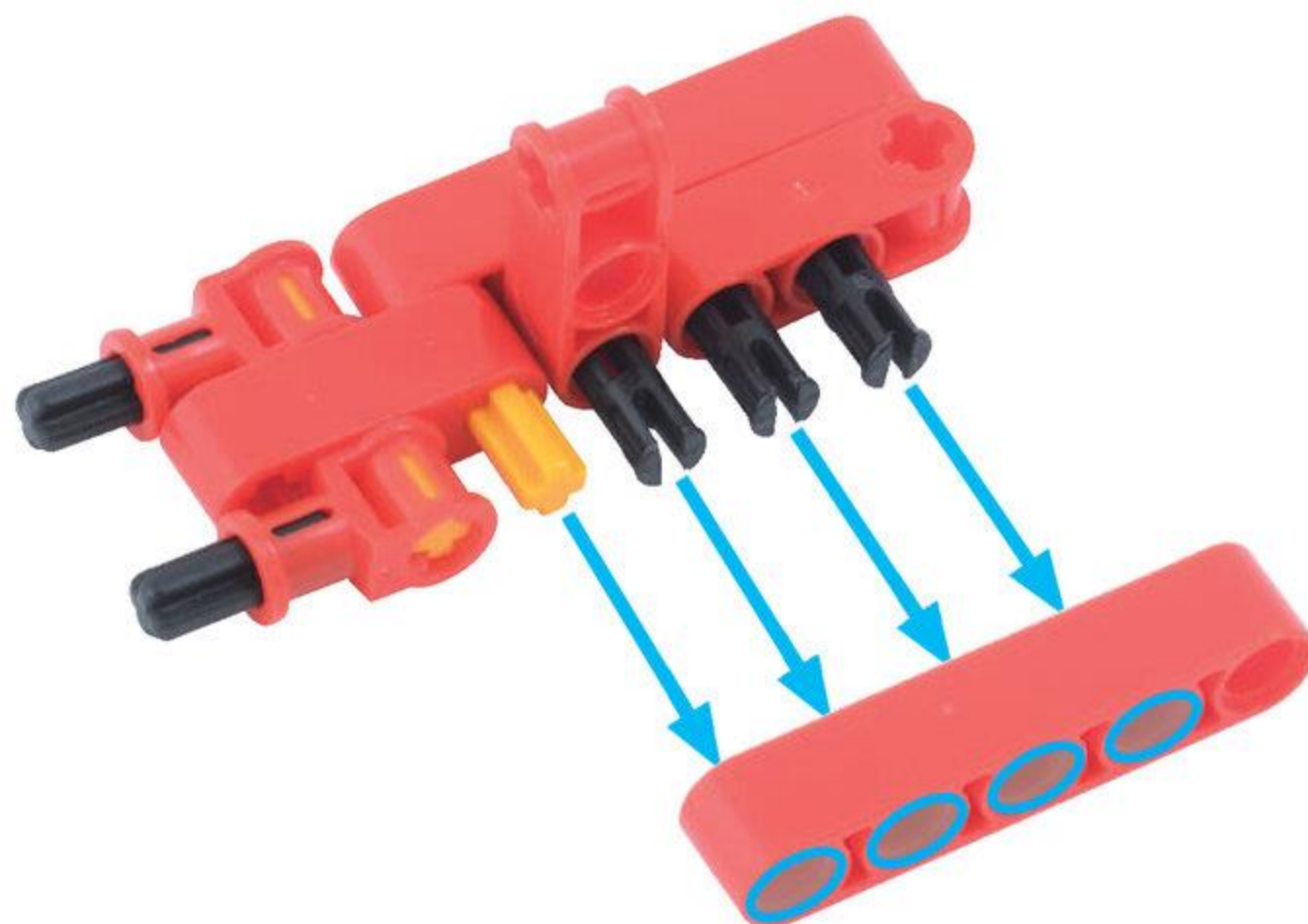



くらんく 2こ



7

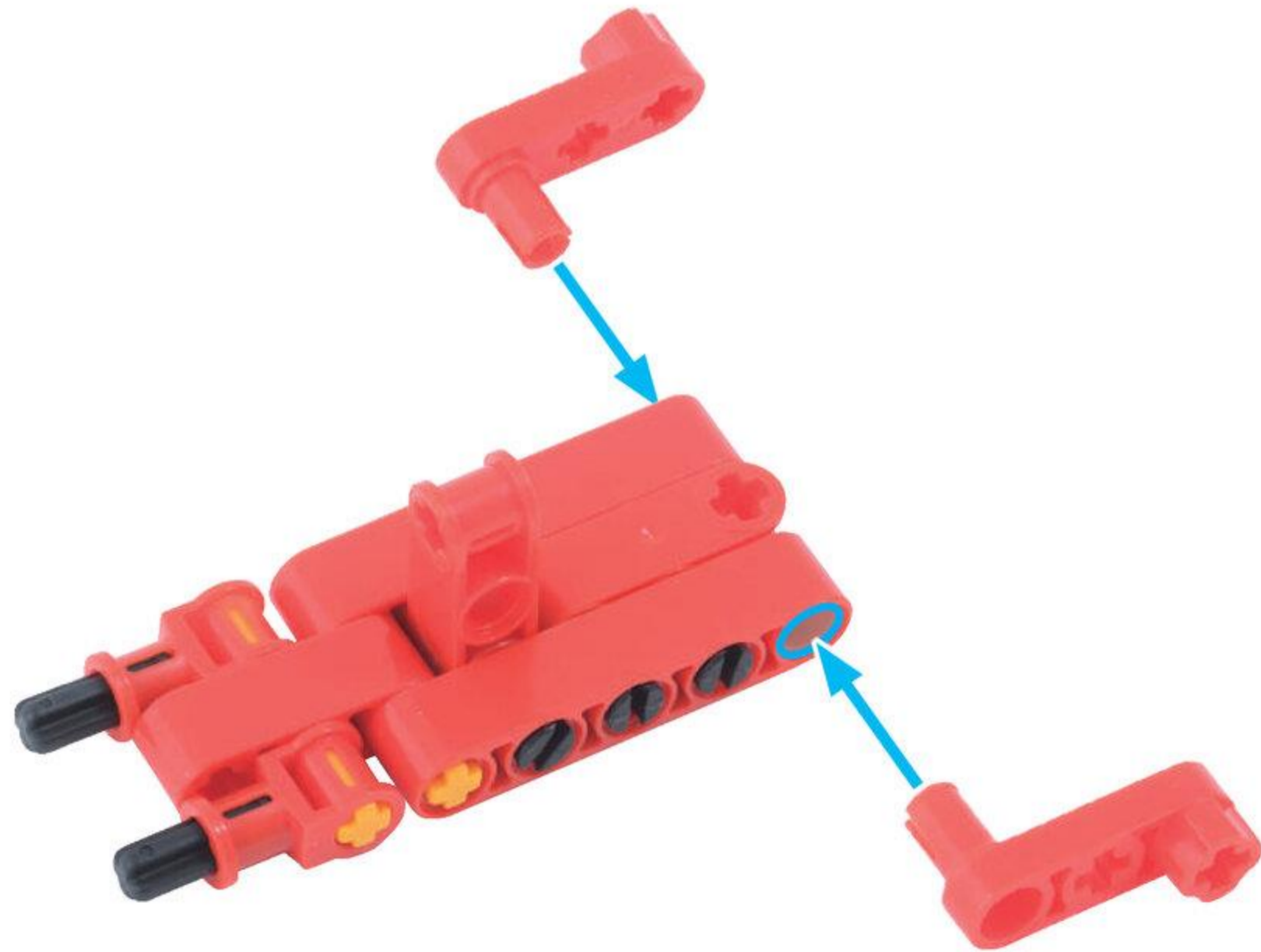

しゃふとペグ  
シャフトペグ 1こ



くろしゃふとにぼち  
黒シャフト2ポチ 1こ



8



9

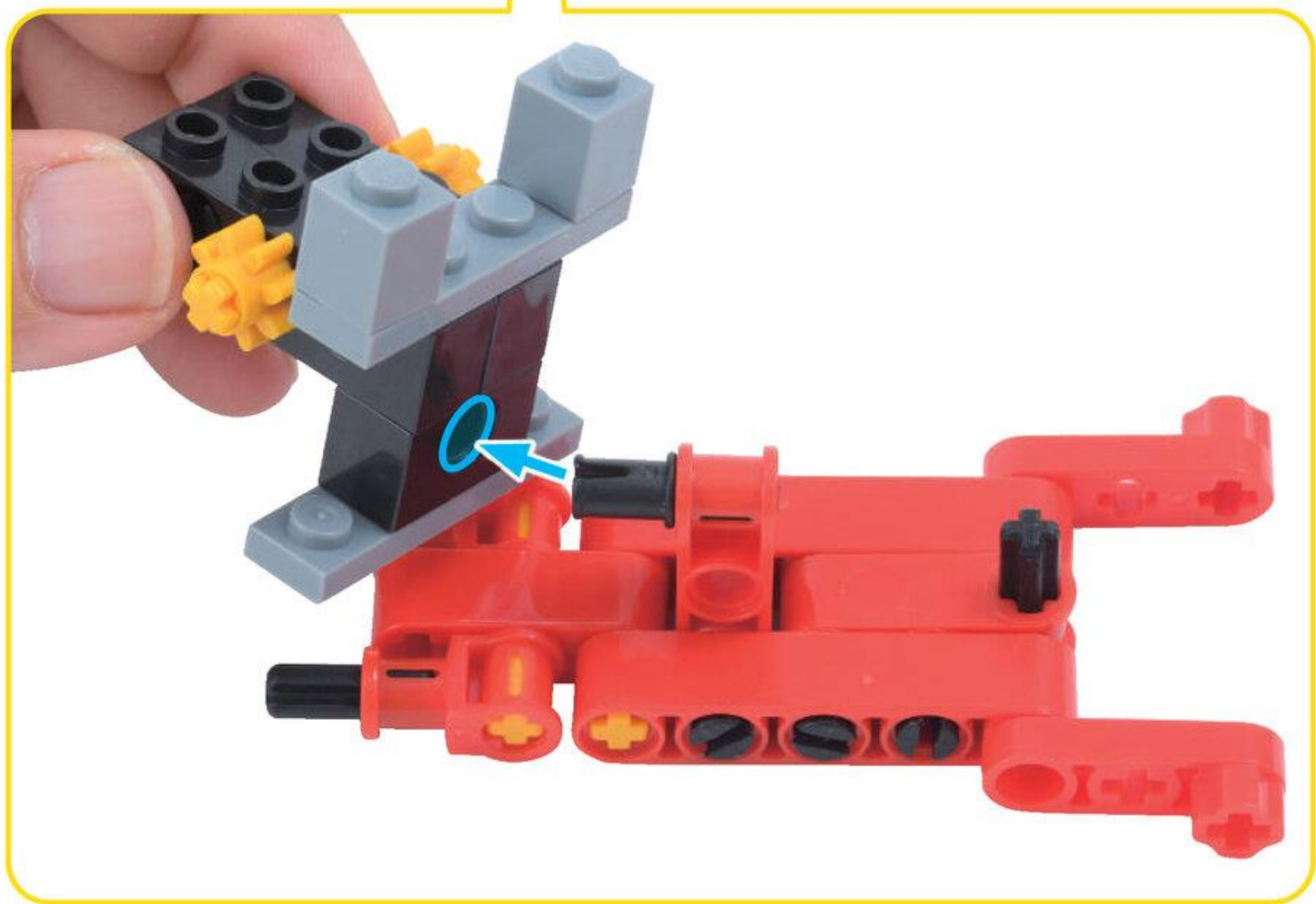
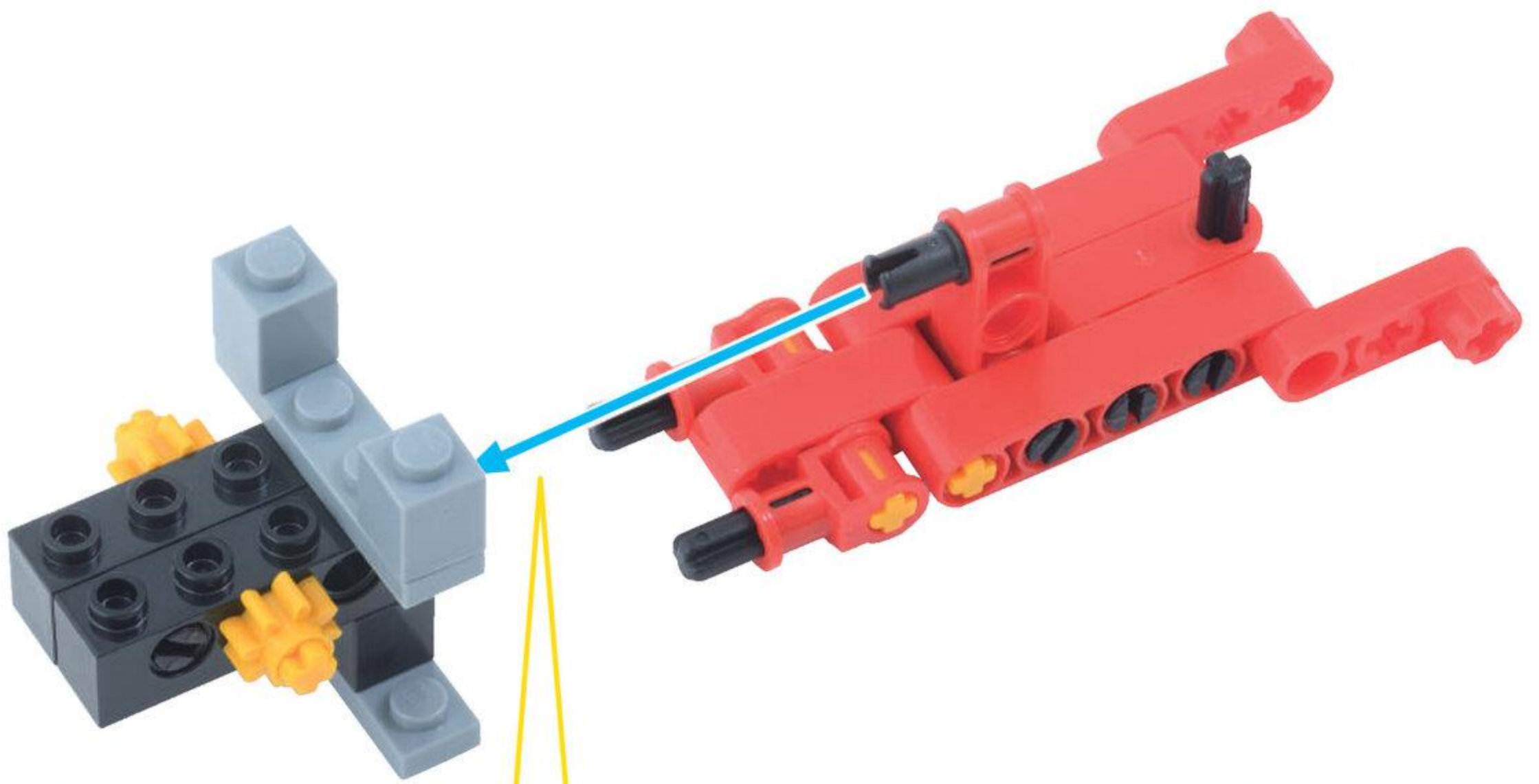

# じゆうにかいぞうしてみよう

めやす 10 ぶん

いぬと いっしょにあそぼう

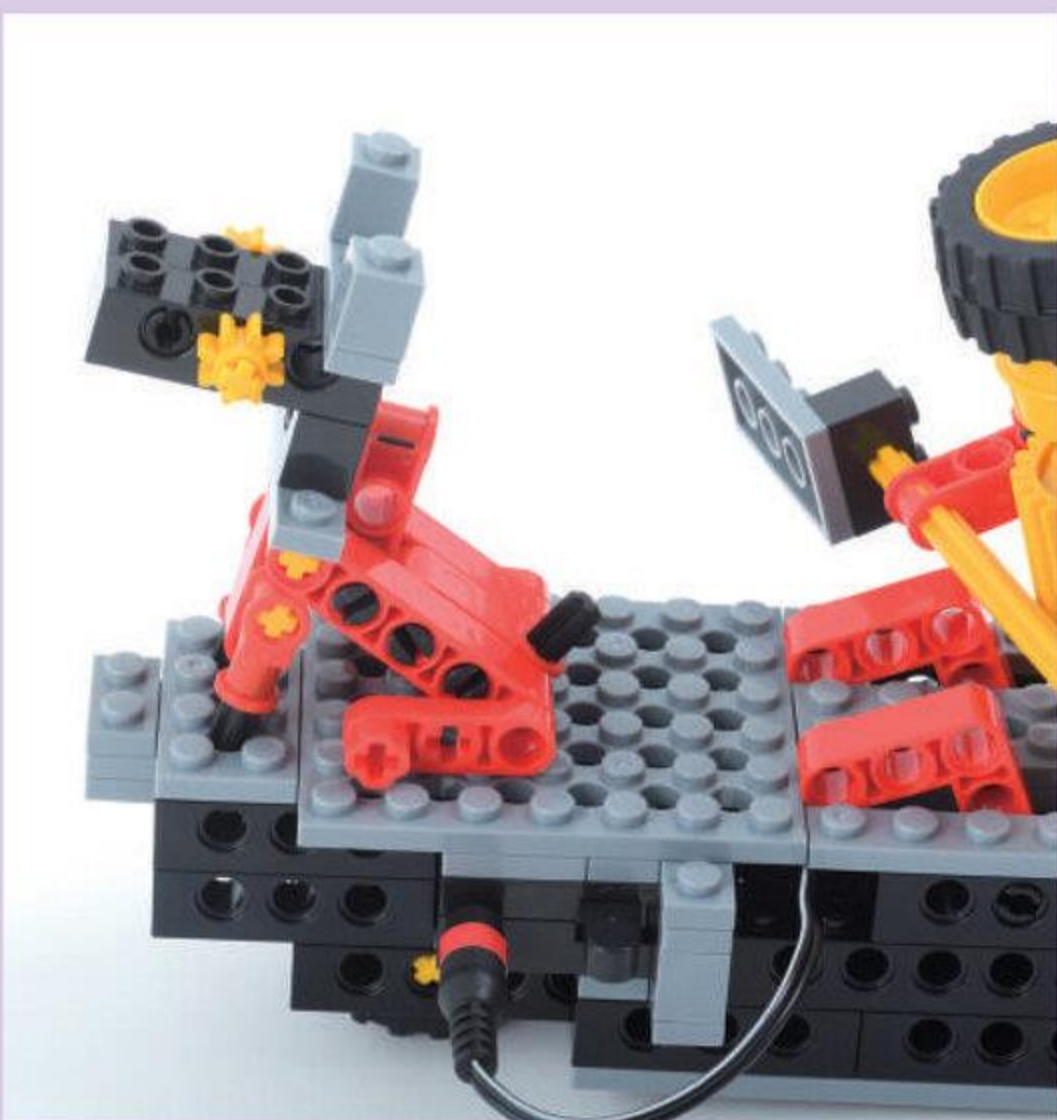
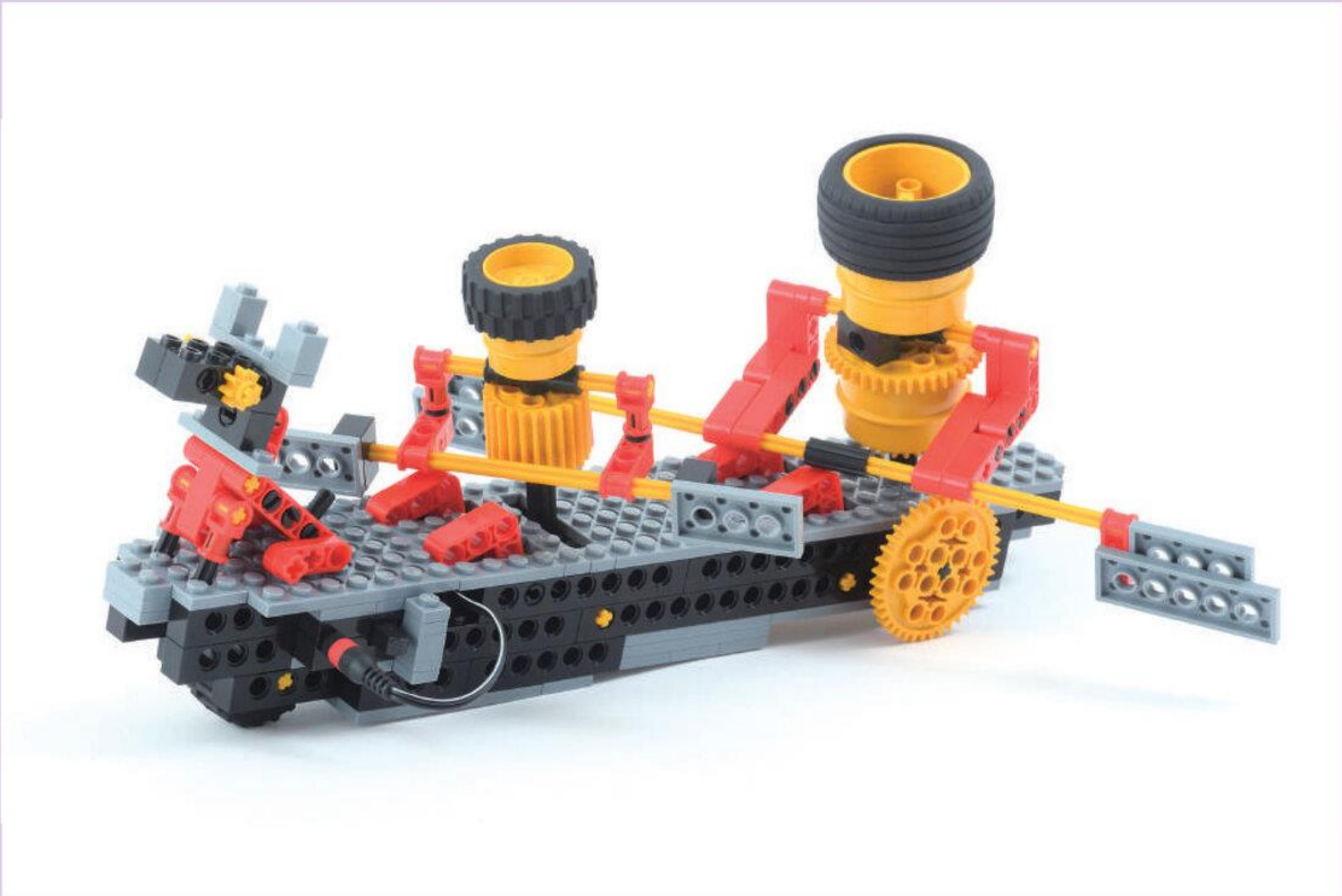

# まちがいさがし

めやす 3 ぶん



ちがうところを みつけよう  
2つあるよ!

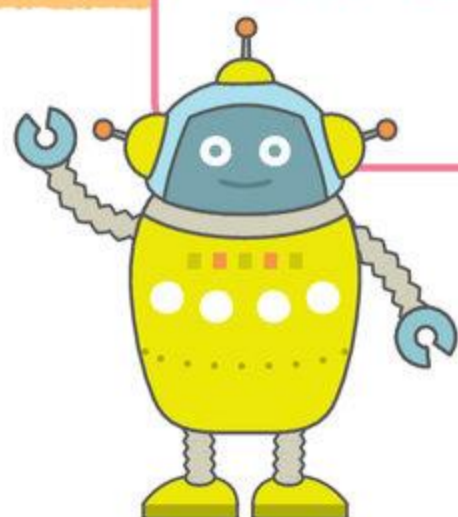

# じかいの ロボット

じかい つくる る ぼ っ と ロボットは

しゅっぱつしんこう

る ぼ れ え る  
「ロボレール」

1 ぽんの れ え る レールの うえを すすんで  
じどうで とまるよ

