

ロボットのきょうかしよ

プレプライマリーコース ㊦

1

しゅっぱつしんこう「ロボレール」
ろぼれえる

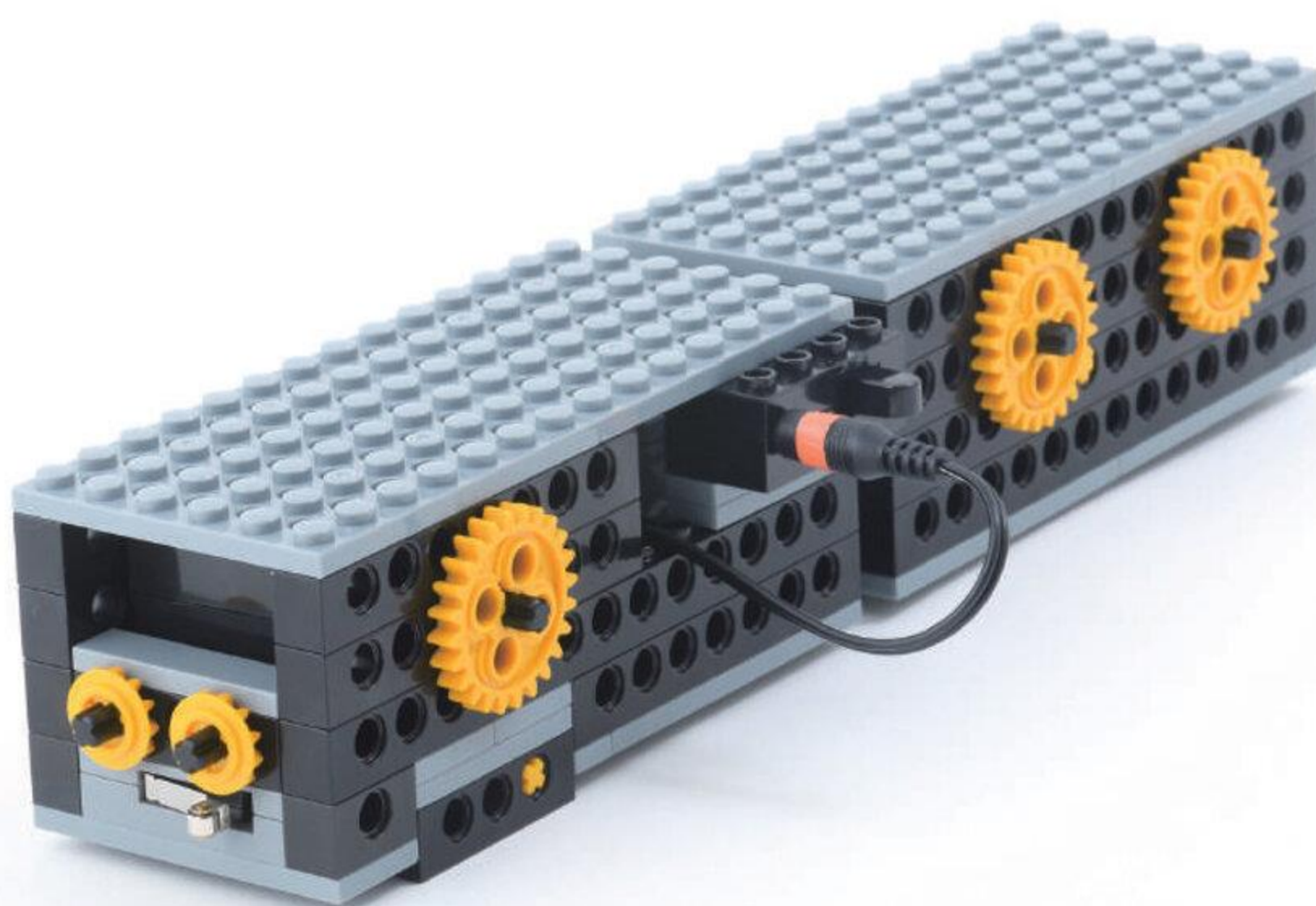

★だい1かい

2023 ねん

10 がつ

にち

なまえ

ちゅうい しょう

ばあっ パーツや でんきぶひんを あんぜんにつかうために

! ばあっ パーツを くちに いれない

くみたてた ばあっ パーツを とりはずすときは、
ぜったいにはをつかてはいけません。
ばあっ パーツを のみこんでは いけません。

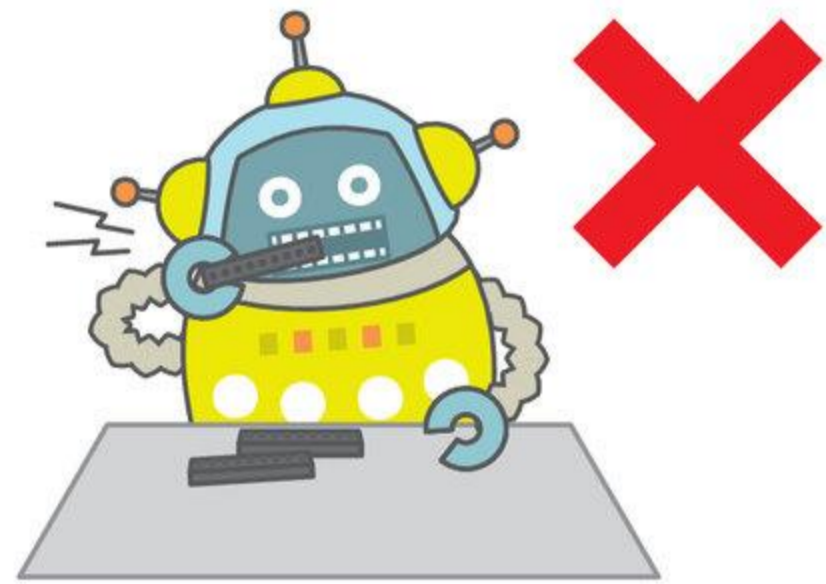

! ぶひんを きずつけない

でんきぶひんを はさみや かつたあ カッターなどで
きずついたり、ばあっ パーツで はさんだりしては
いけません (しゃしん 1)。

こおど や けえぶる コードや ケーブルは、おりまげたり、
ひっぱたりしては いけません。

ぶらぐ の めきさしは、ぶらぐぶぶんを
もって おこないましょう (しゃしん 2)。

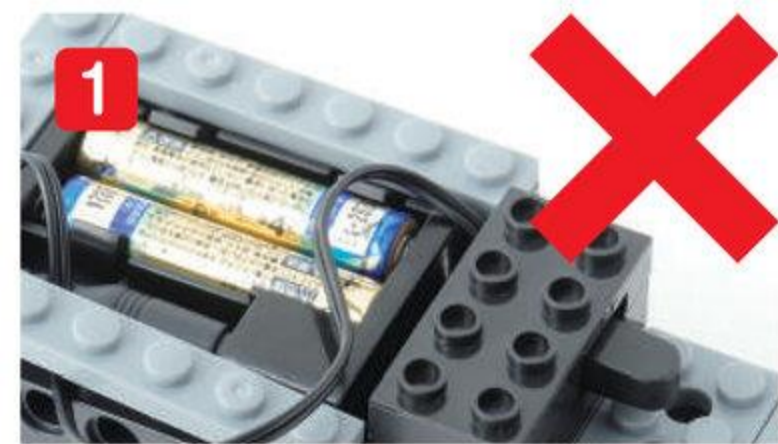

! あつい・におうとき、へんなおとが するとき

ろほっと ロボットを うごかしたときに、でんちや でんきぶひんが
あつくなったり、へんな においが したり、いつもと ちがうおとが
したばあいは、すぐに ロボットを とめ、せんせいに しらせましょう。
ぬれたてで でんきぶひんを さわってはいけません。

もくじ

だい 1 かい

ろぼっとの ぶんかい	3	10ぷん
かんがえてみよう	3~4	12ぷん
きょうの パーツ	5	
きょうの よてい	6	
くみたて		
1. まえの しゃりょう	7~25	60ぷん
2. うしろの しゃりょう	26~37	
3. れんけつ	38~39	
4. まど	40~42	
ろぼっとを うごかさう	43	
くいず	44	3ぷん
かたづけ		5ぷん

ふるっく
ブロックはずし



つかうと べんりだよ

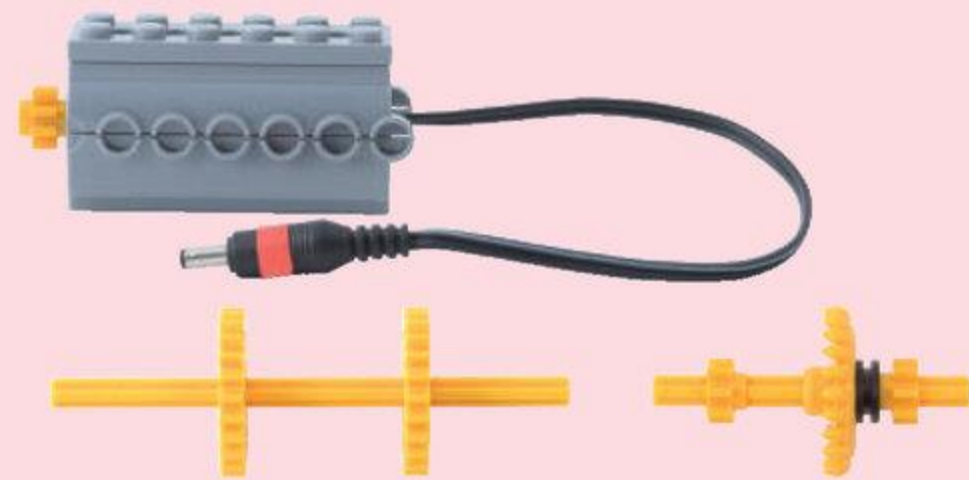

このセットは くずさないでね! またつかうよ



かんがえてみよう

めやす 5 ぷん



もの れ える
モノレールを しっているかな?
ふつうの でんしゃと
どこが ちがうかな?

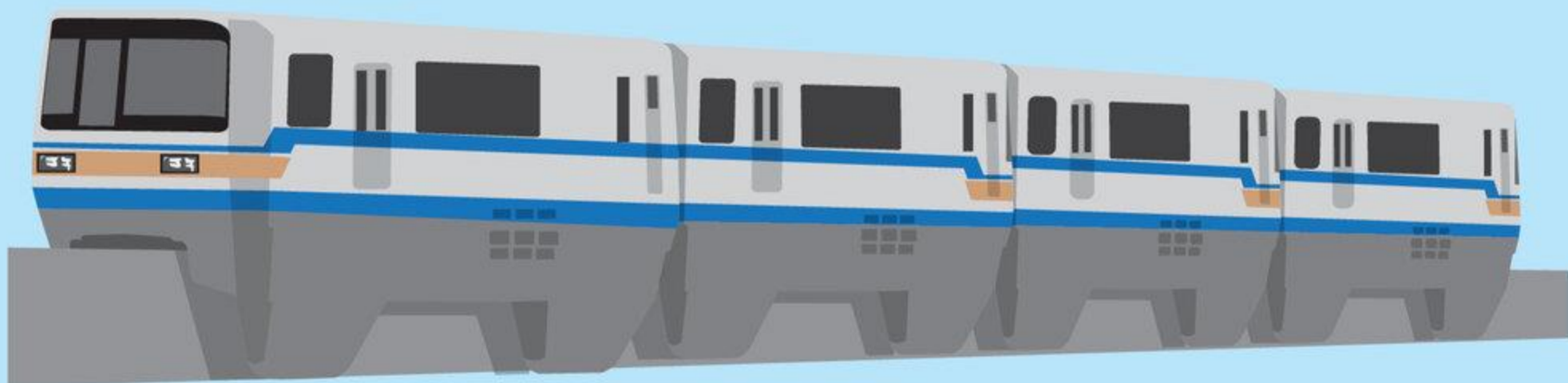



ものれえる
モノレールは
れえる
レールが 1 ぽんしか ないよ



ふつうの でんしゃは
れえる
2 ぽんの レールの うえを はするよ

ものれえる
モノレールは
れえる
1 ぽんの レールの うえを はするよ
もの
(「モノ」は「ひとつ」の いみだよ)



る ぼれえる れえる
ロボレールの レールは 1 ぽんだよ
だい 2 かいで つくるよ!



おたのしみに!



めやす 5 ふん

ふとぶれえと
太プレート

ほそぶれえと
細プレート

パーツをみつけよう

ふとぶれえと
太プレートは
3つのなかまがいるよ

ほそぶれえと
細プレートは
4つのなかまがいるよ

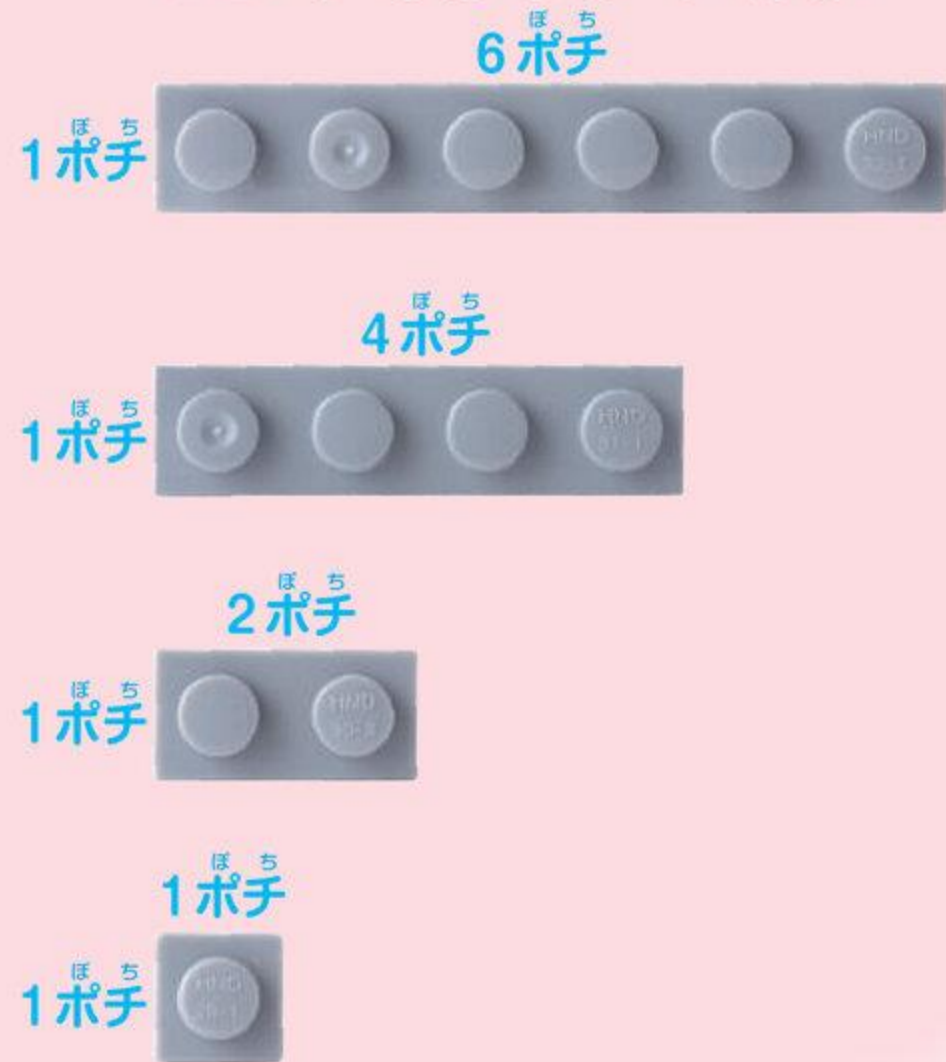
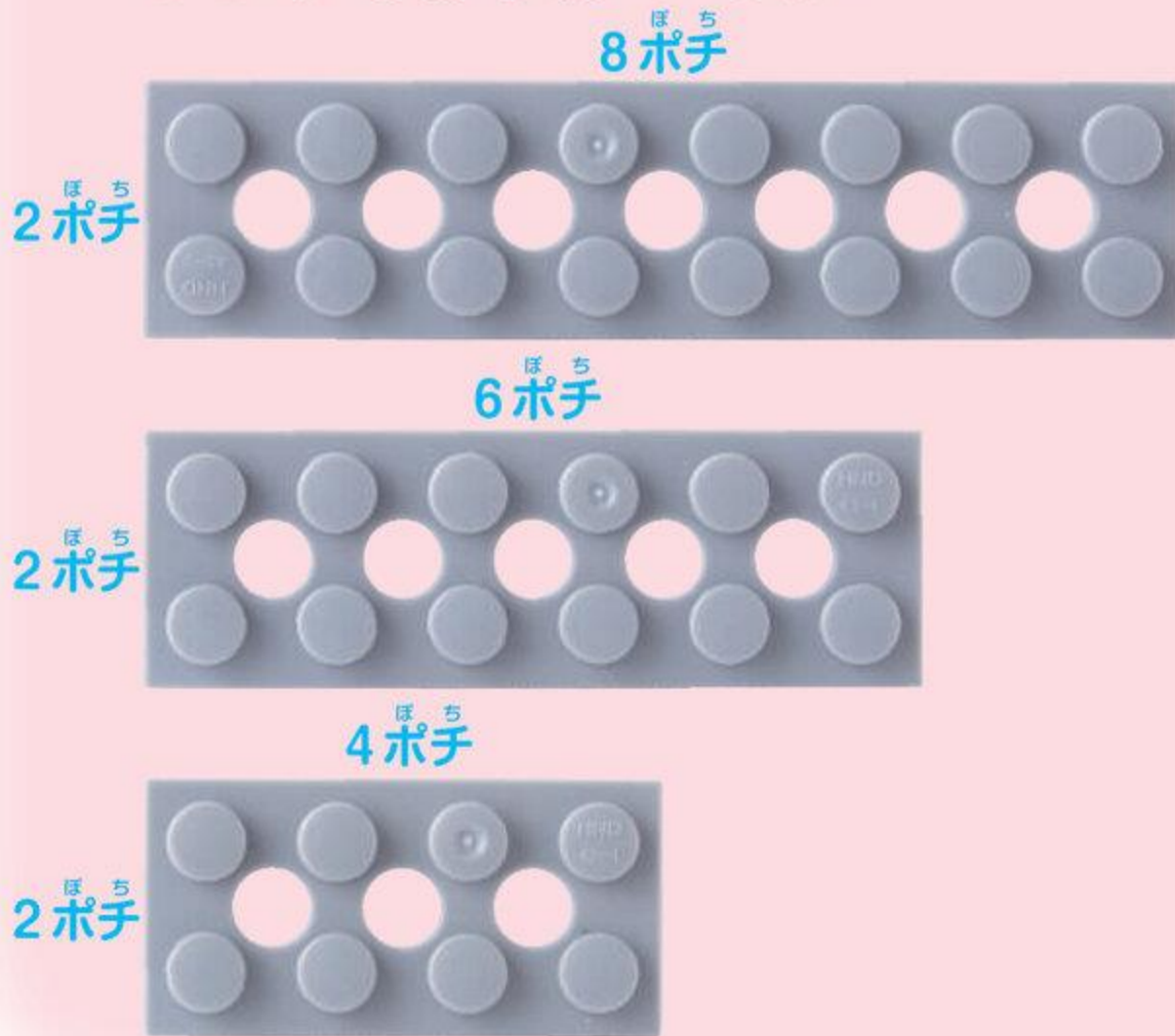

とくちょう

ぶれえと
プレートは3まいかさねるとビームのたかさになるよ
たかさをあわせるときにつかうよ

よこから
みたところ



びいむ
ビーム



ふとぶれえと
太プレート



ほそぶれえと
細プレート

ぶれえと
「プレート」は
「いた」の
いみだよ

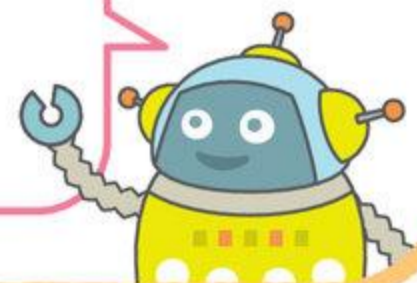

マスターしよう

ながいプレートは
パーツどうしのはしわたしができるよ

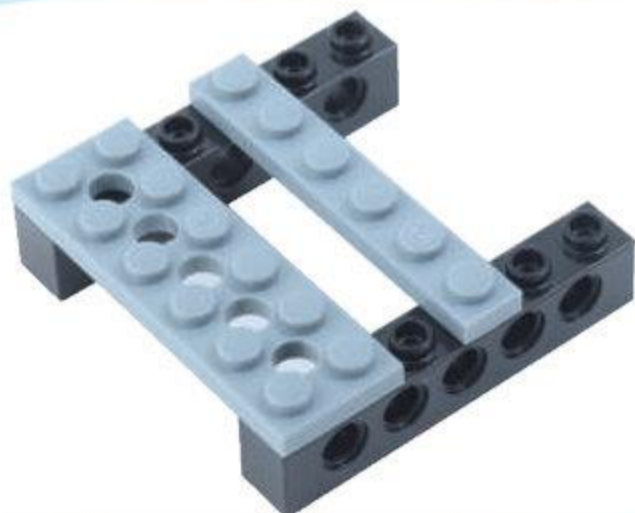

ふとぶれえと
太プレートは
あなにシャフトやペグを
さすことができるよ

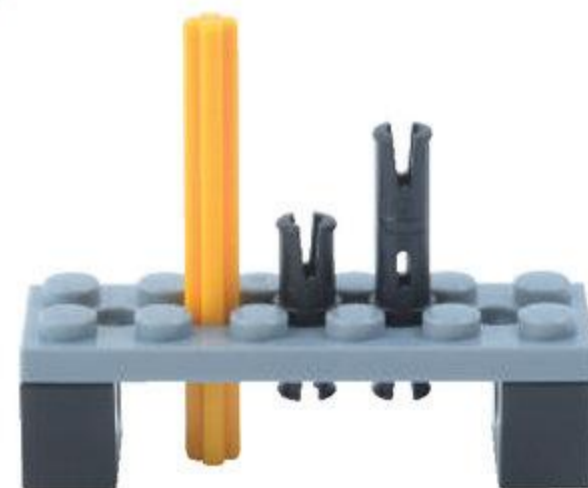

きょうの よてい

めやす 2 ふん

このじゅんばんでつくるよ!

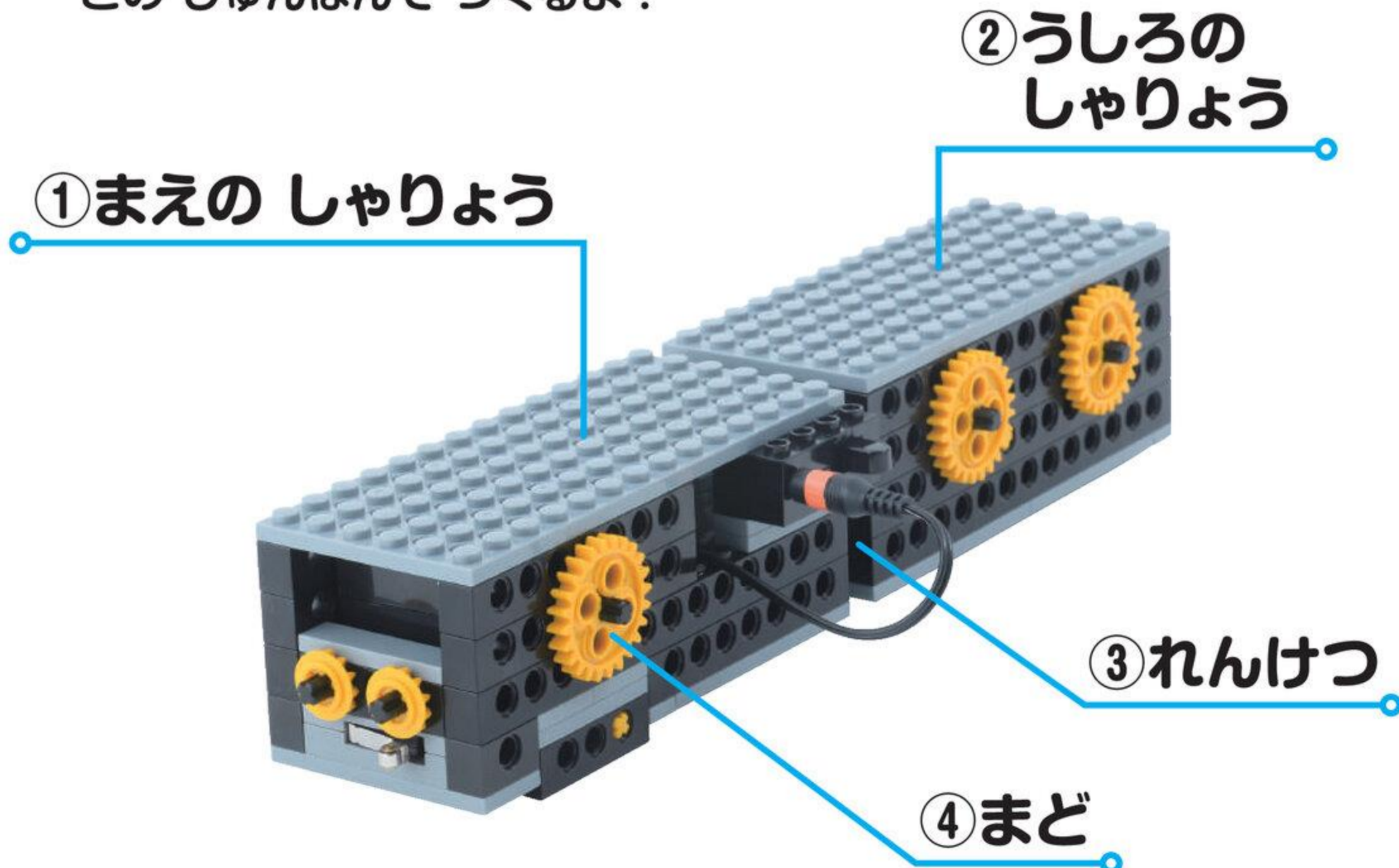

①まへのしゃりょう

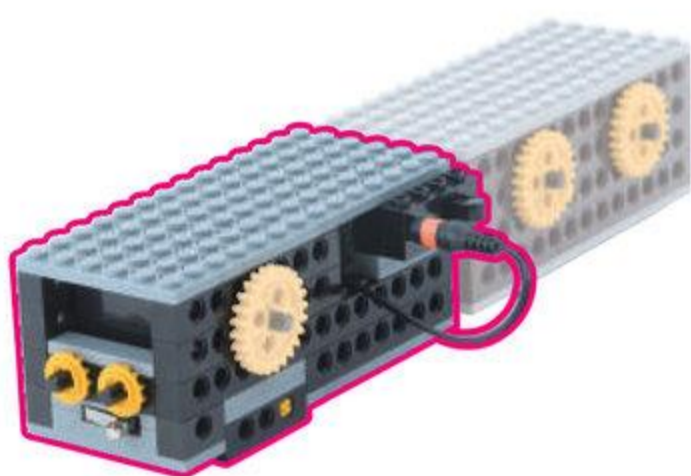

②うしろのしゃりょう

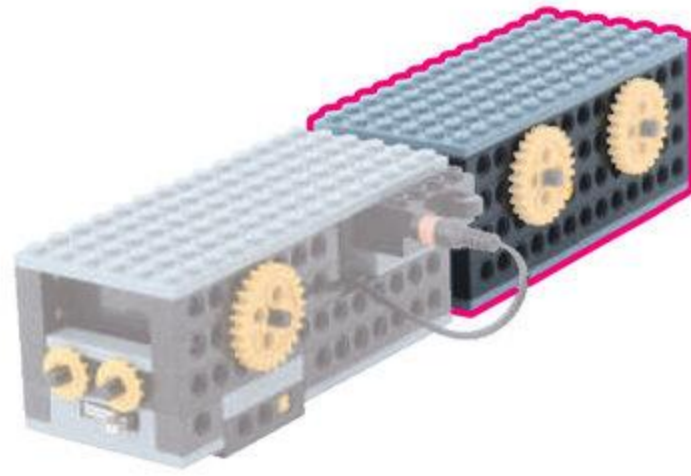

③れんけつ

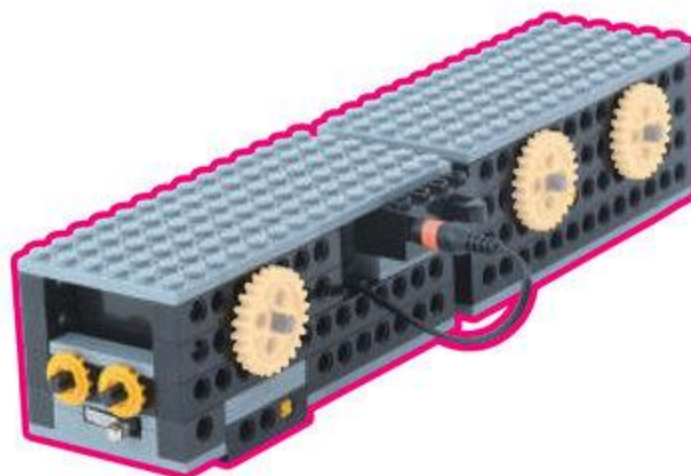

④まど

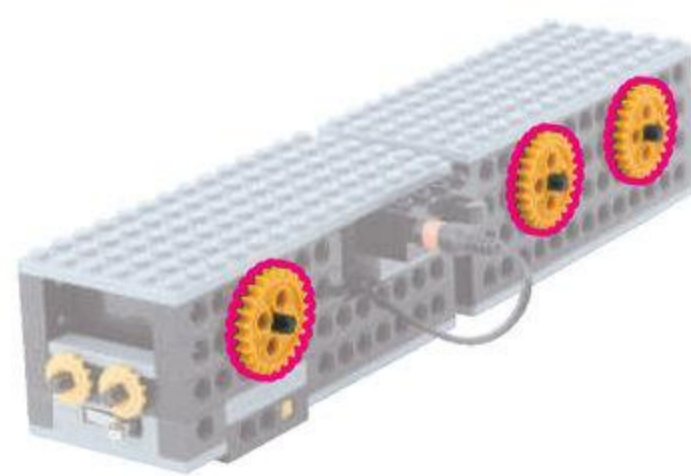

1 まえのしゃりょう

めやす 20 ぶん

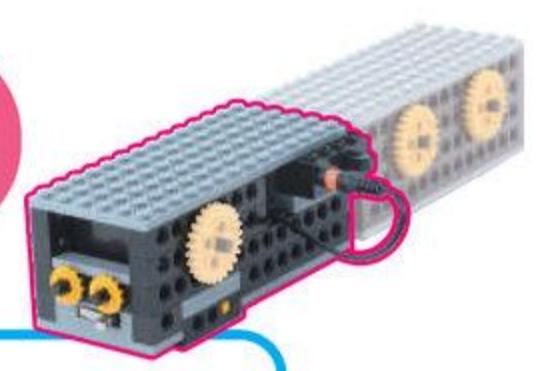

びいむ じゅうよん ぽち
ビーム 14 ポチ **3** こ



びいむ はち ぽち
ビーム 8 ポチ **1** こ



1

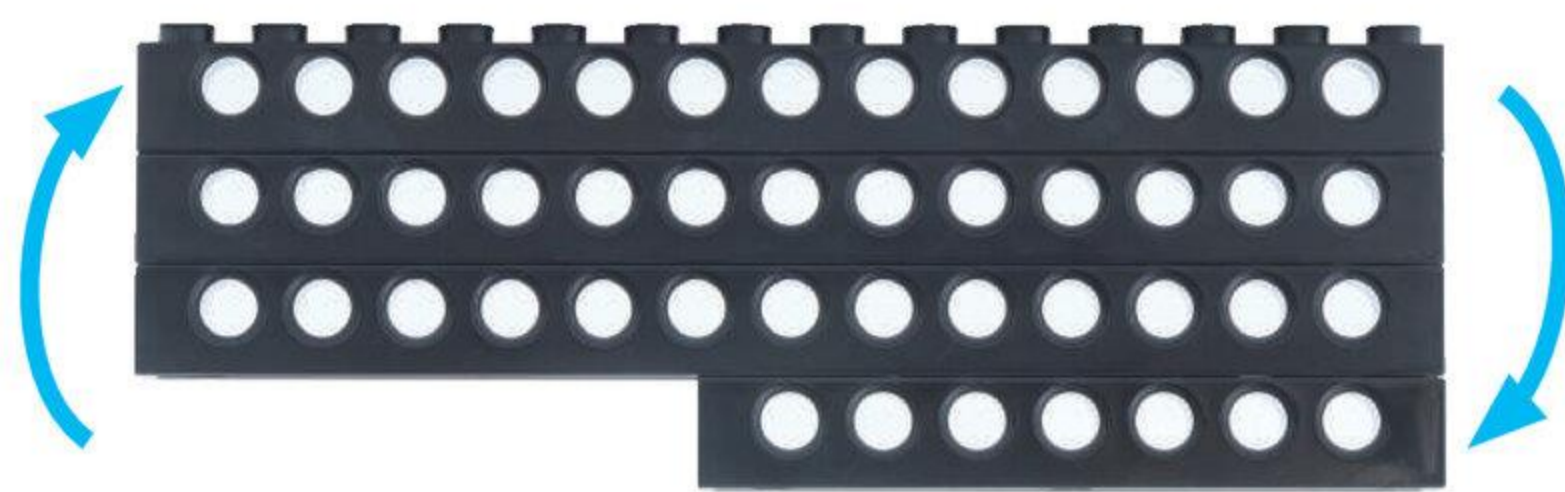

くみたてた ばあつ パーツを
じょうげ ぎやくに
するよ

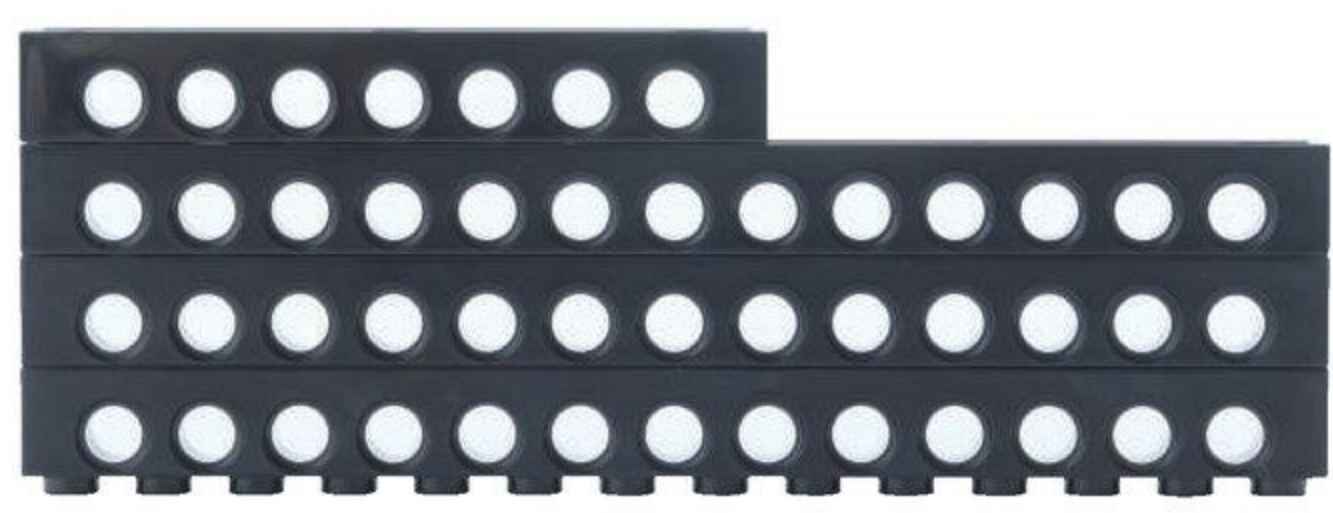
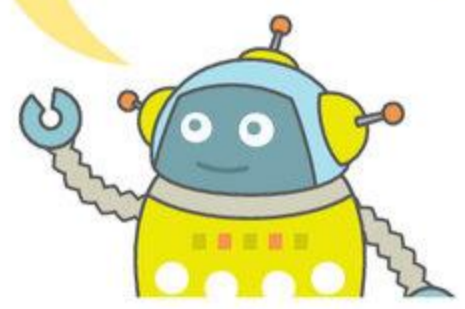

1 プレプライマリコース 10がつ

ぶれえとる
プレート 2こ

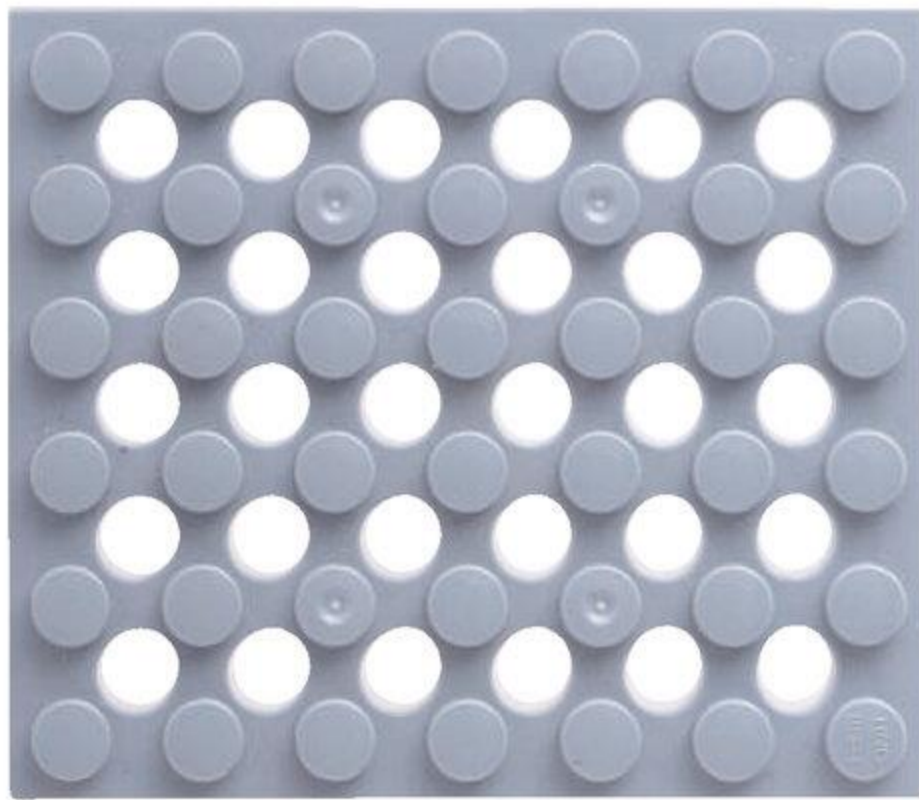

うら

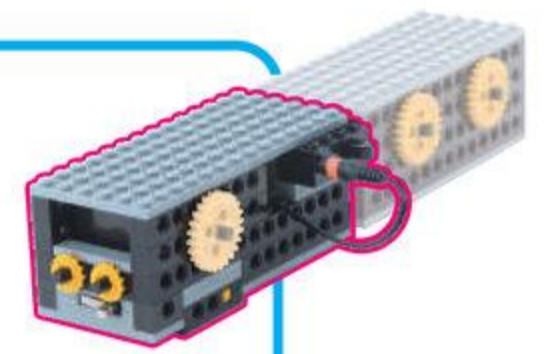
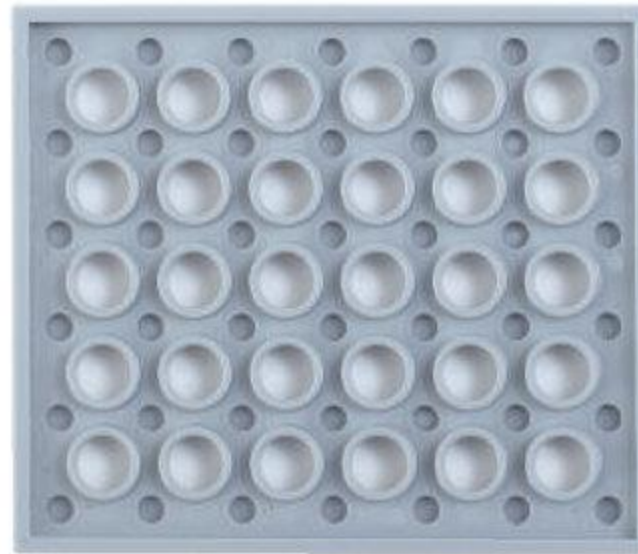

2

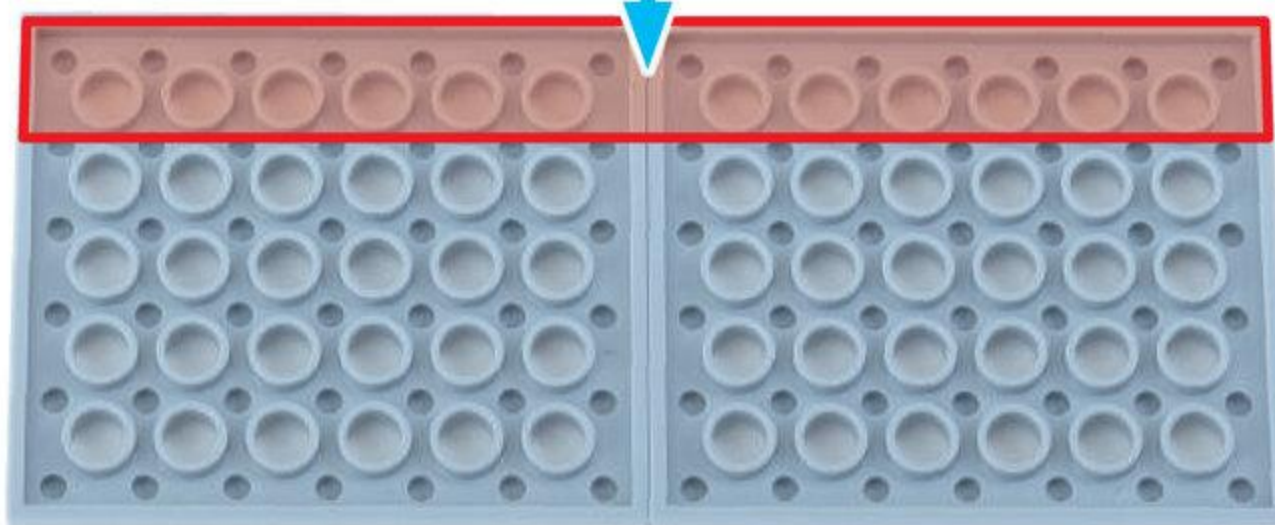
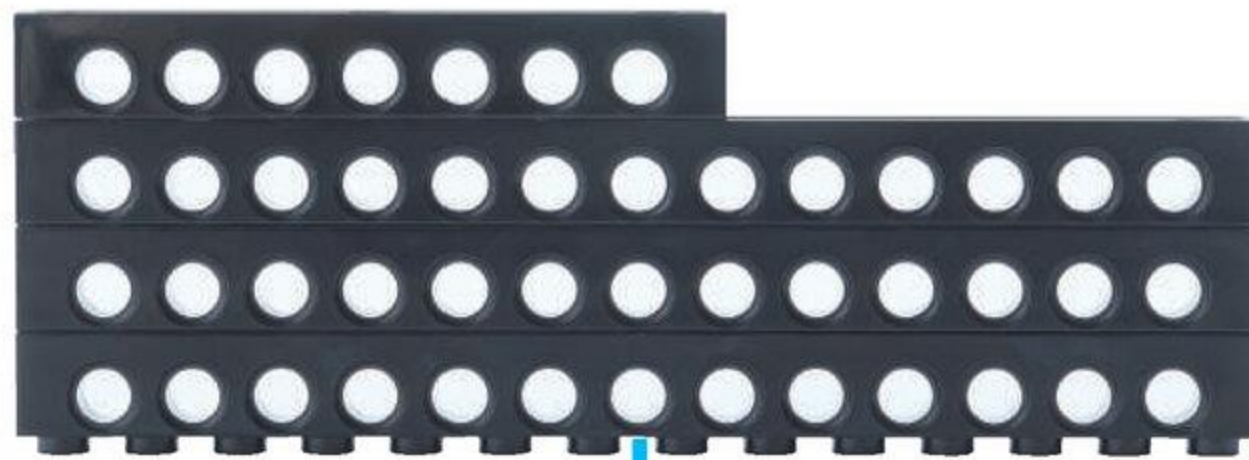

うらがえして
おこそう

ながさに ちゅうい
ながい

みじかい

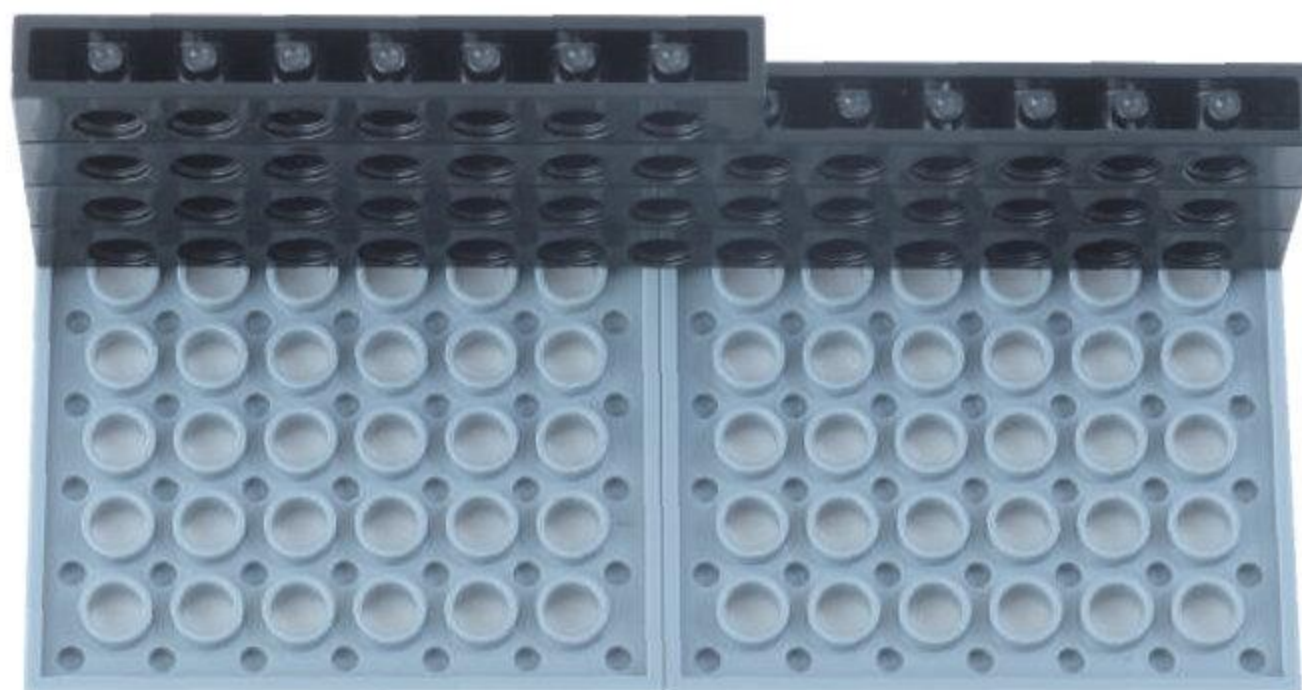
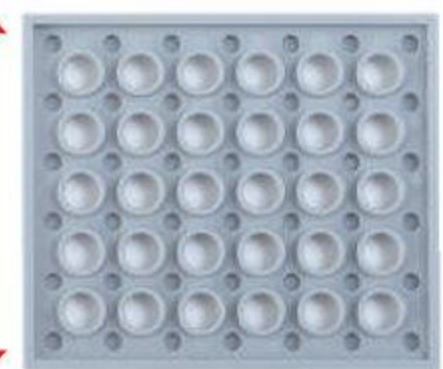

ばってりいほっくす すらいどすいっち 1こ
バッテリーボックス / スライドスイッチ 1こ

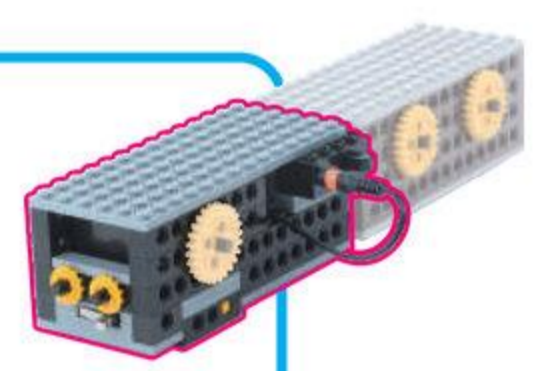

3

うらがえして
おこそう



ほち
1 ポチぶん
はみでるよ

ほち
1 ポチぶん

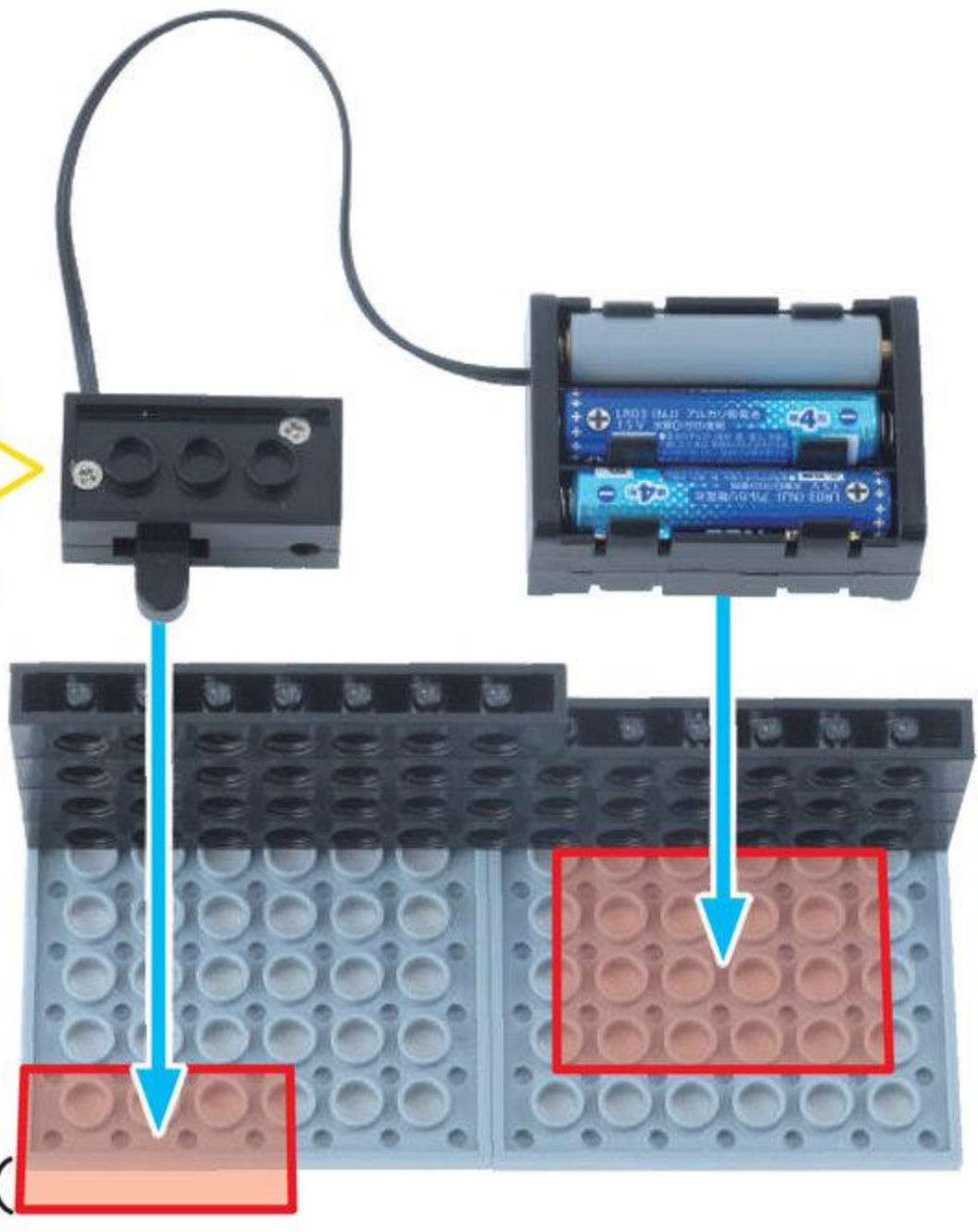

ほそぶれえとよんぼち
細プレート4ポチ 2こ



うら

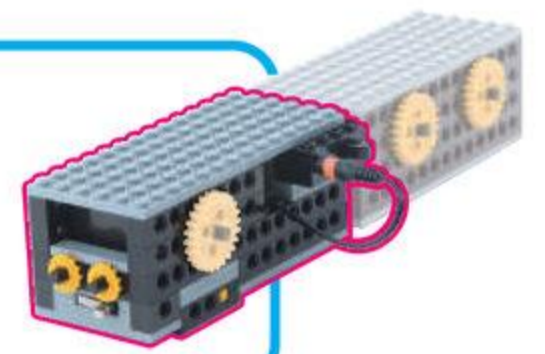

4

うらがえして
おこご



うらがえして
おこご



びいむじゅうよんほち
ビーム 14 ポチ 1 こ

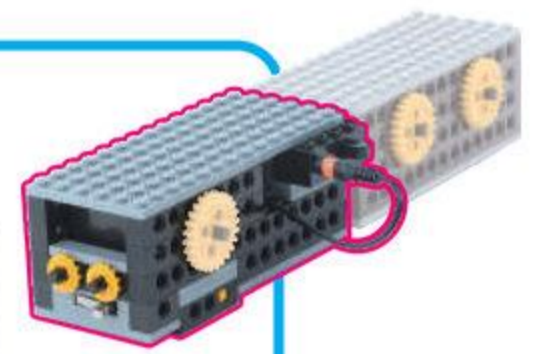

びいむはちほち
ビーム 8 ポチ 3 こ



5

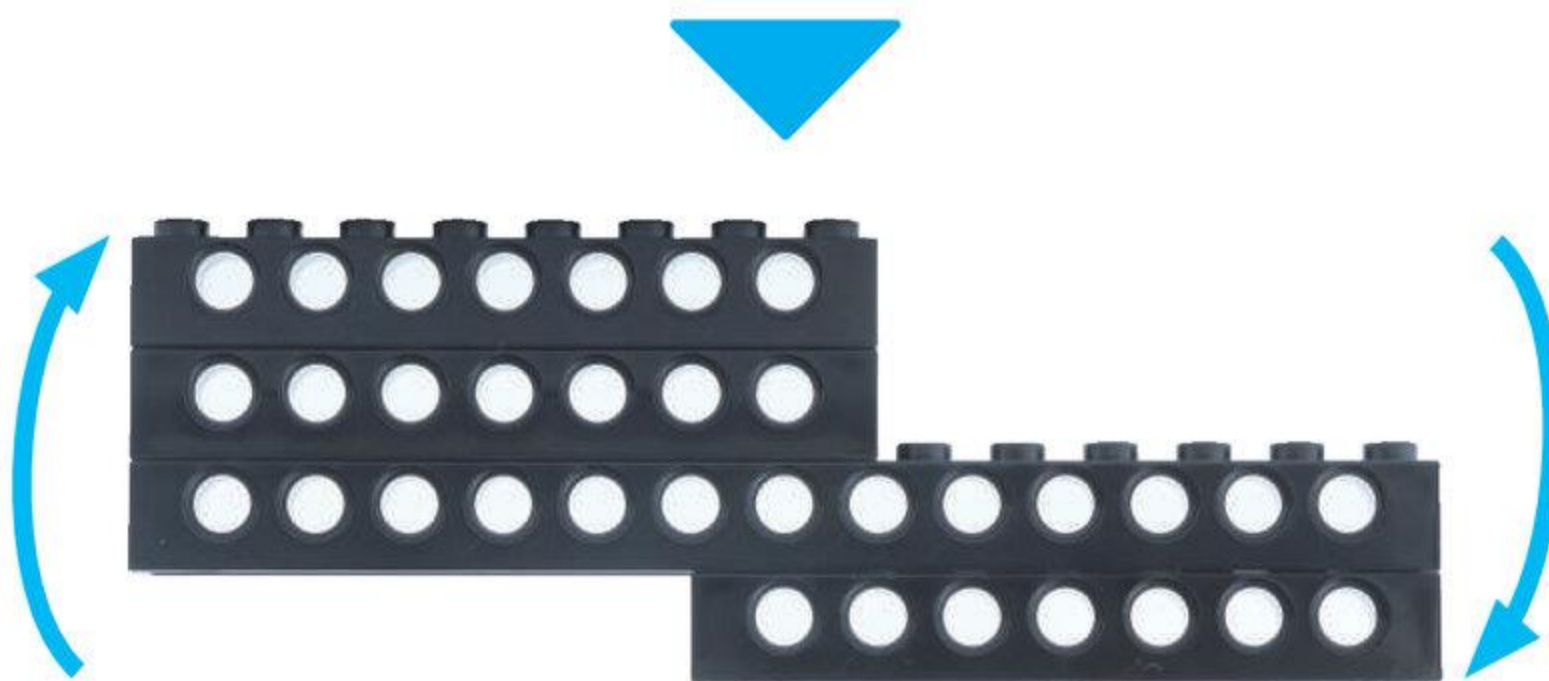
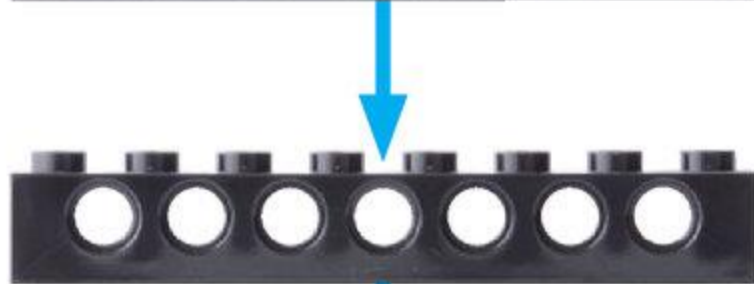

くみたてた^{ばあつ}パーツを
じょうげぎやくに
するよ

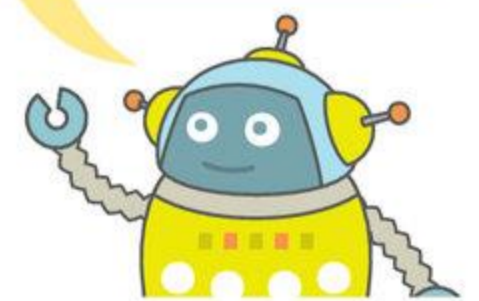

6

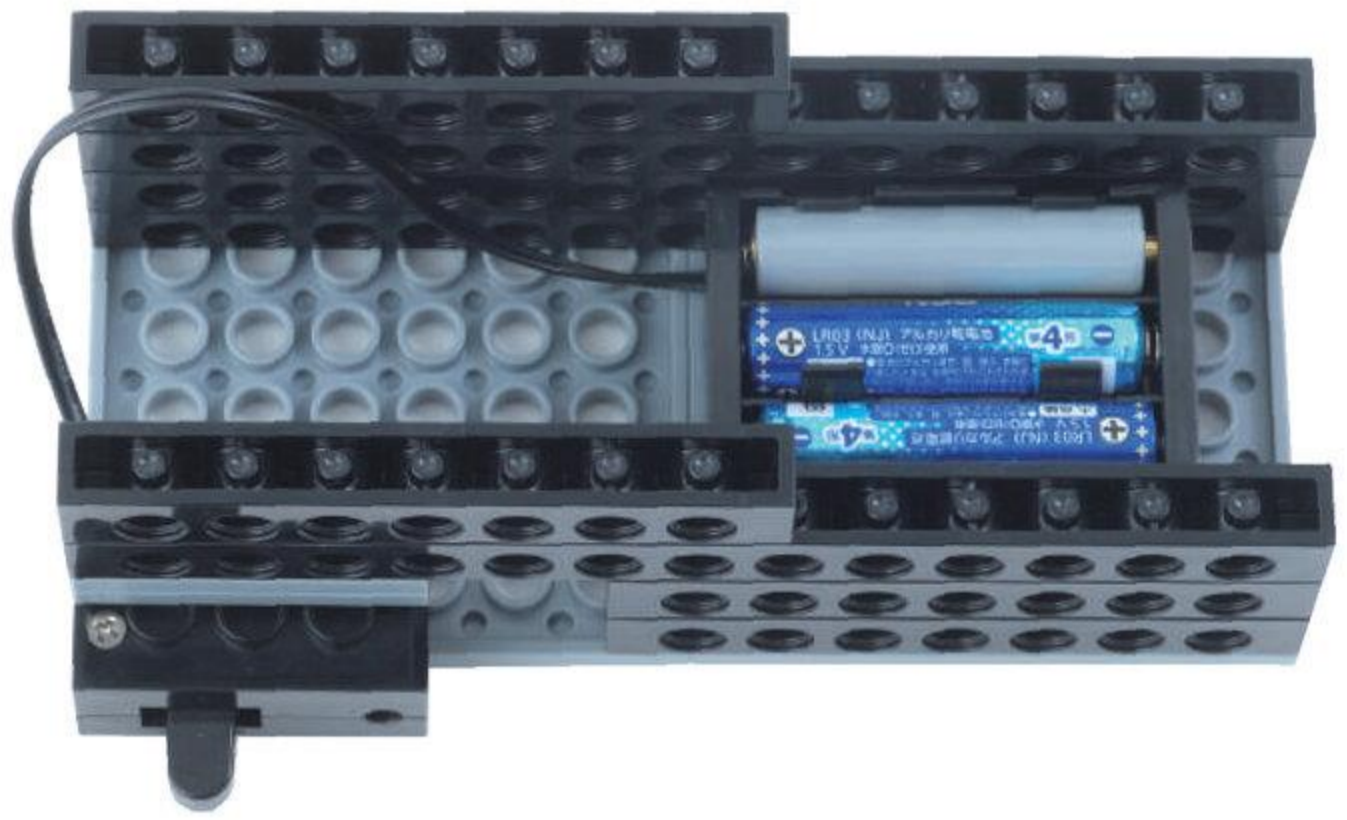
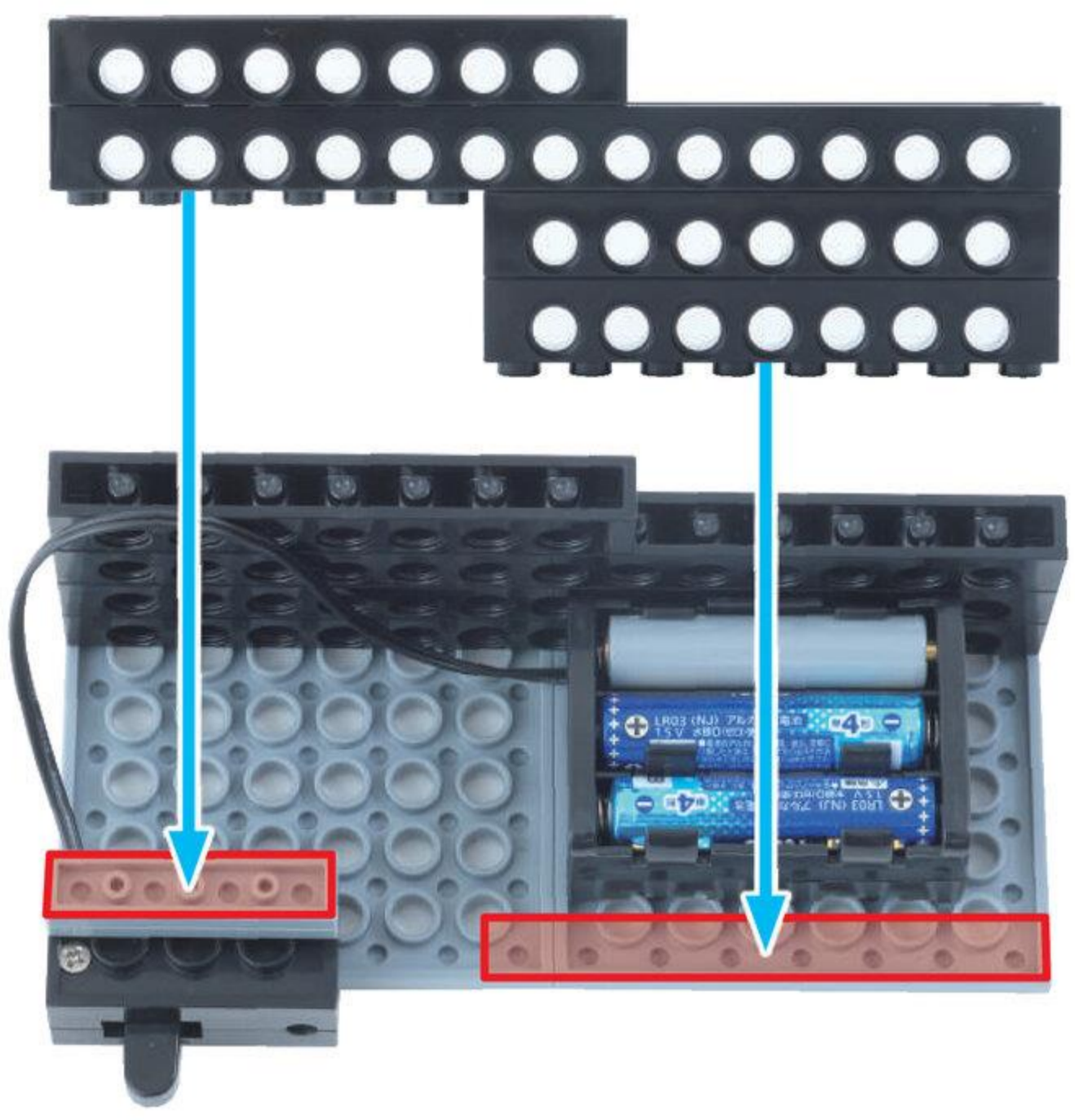
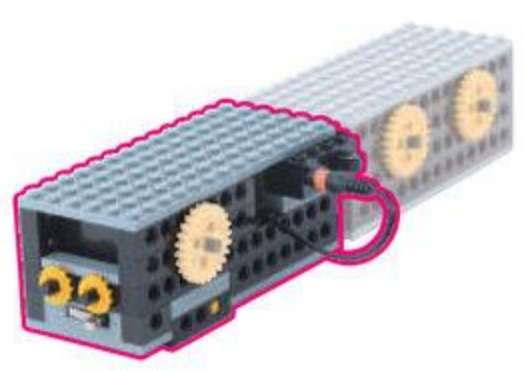

ふとぶれえとろくぼち
太プレート6ポチ **1こ**

たっちせんさあぐれえ
タッチセンサーグレー **1こ**

びいむにほち
ビーム2ポチ **2こ**

7

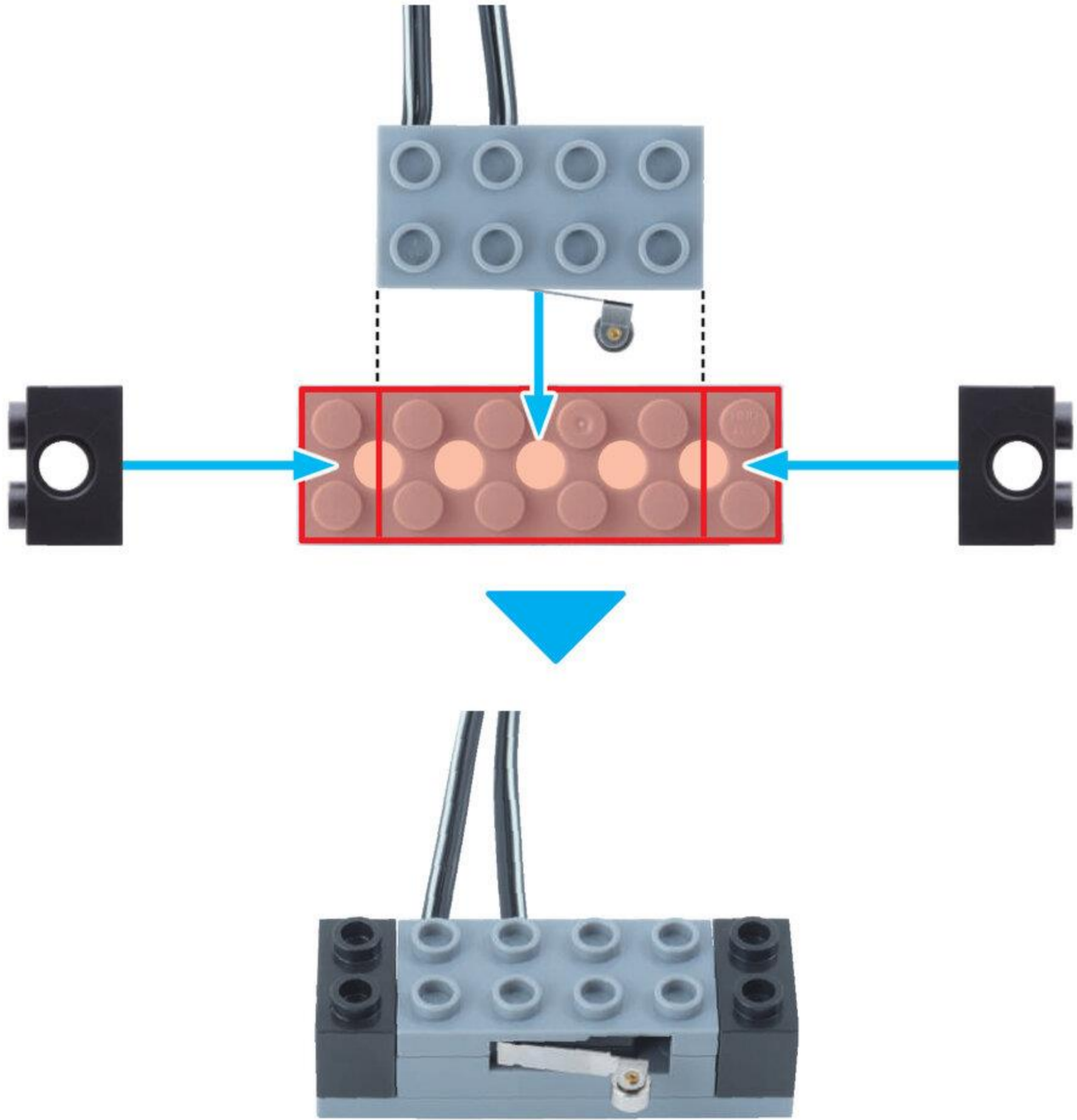

まいたぎあ
マイタギア 2こ



うら



びいむよんぼち
ビーム 4ポチ 1こ

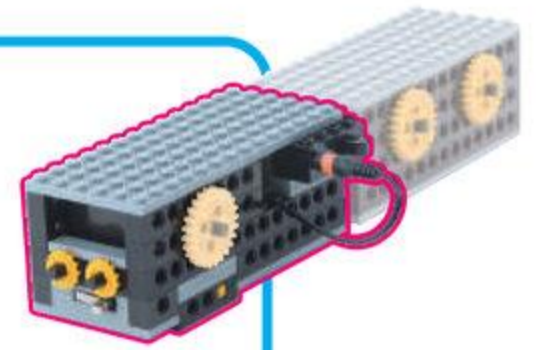

しゃふとペグ
シャフトペグ 2こ



8

うらがえして
おこ



うらがえして
おこ



9

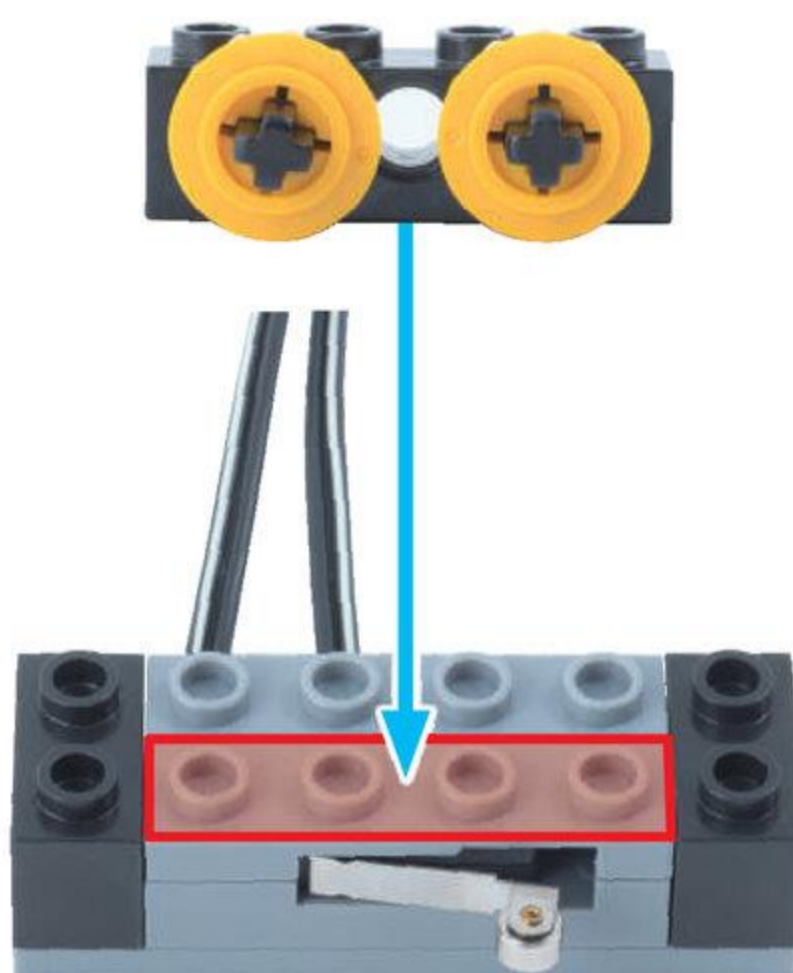
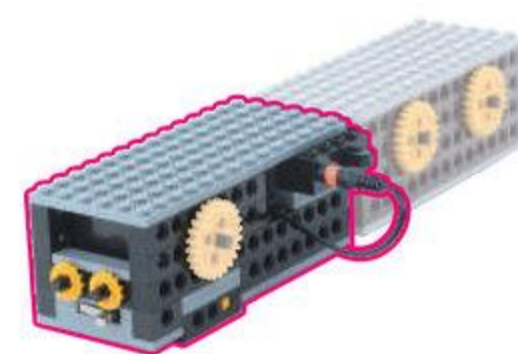

たいる
タイル 1こ

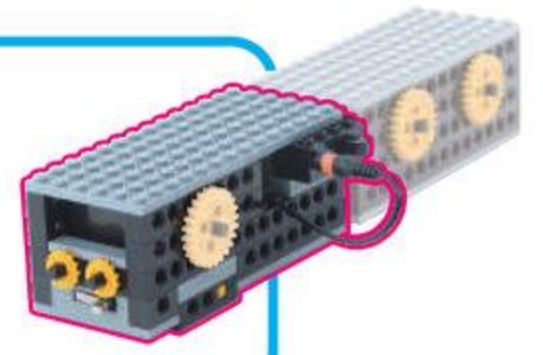

10

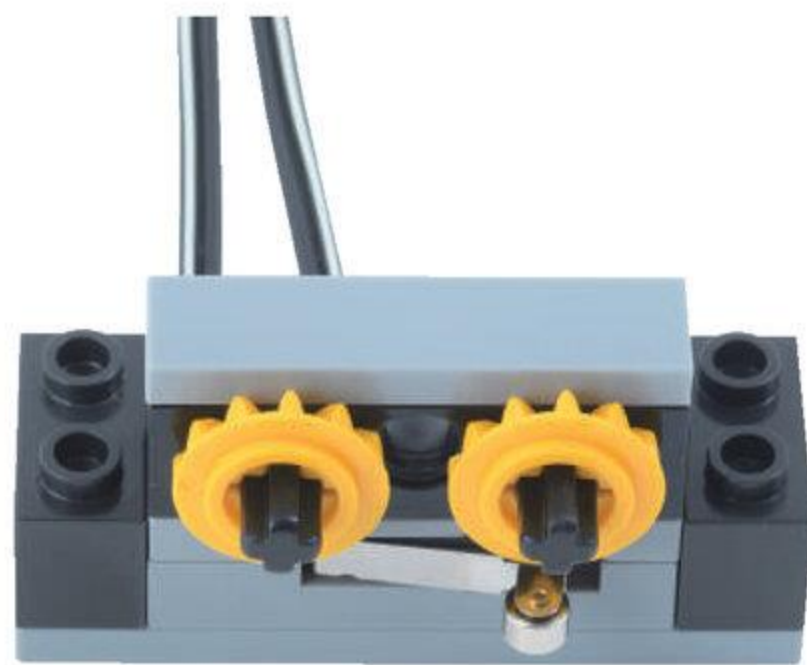
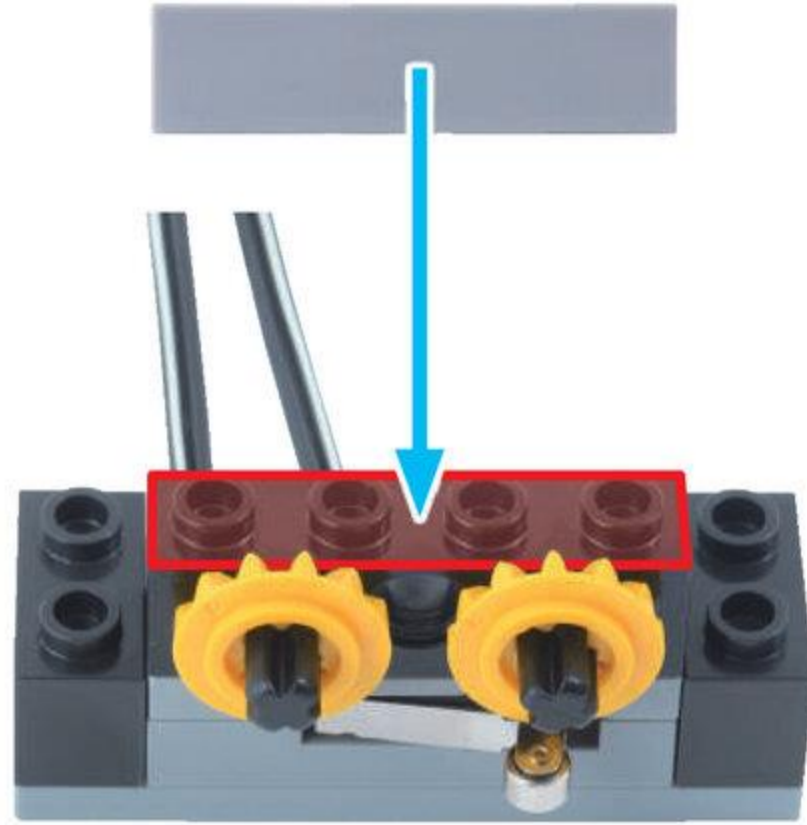

くみたてた^{ぱあっ}パーツを
うらがえすよ

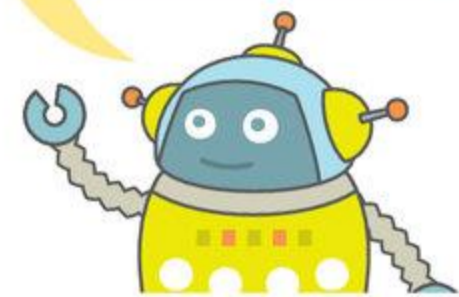

11

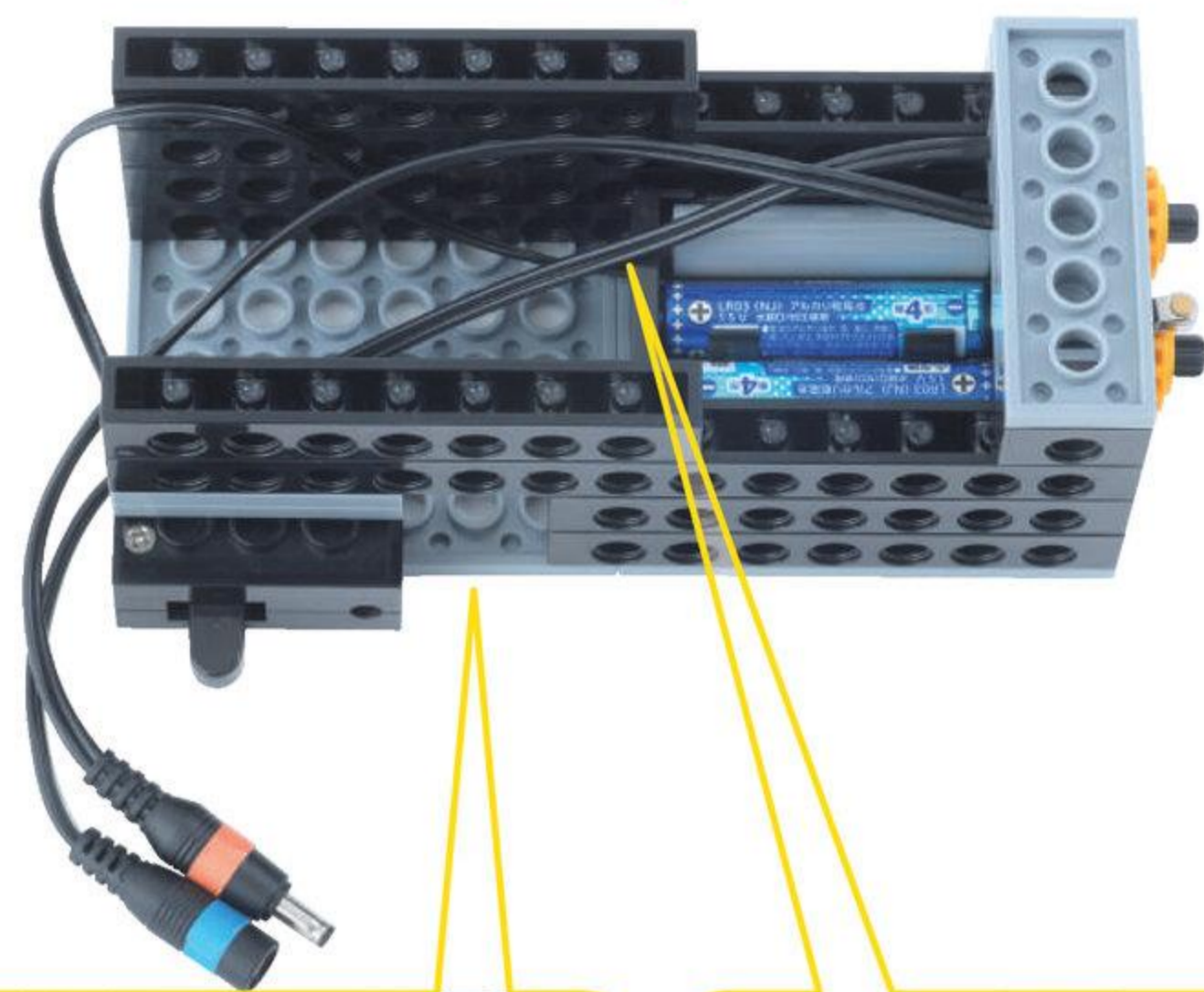
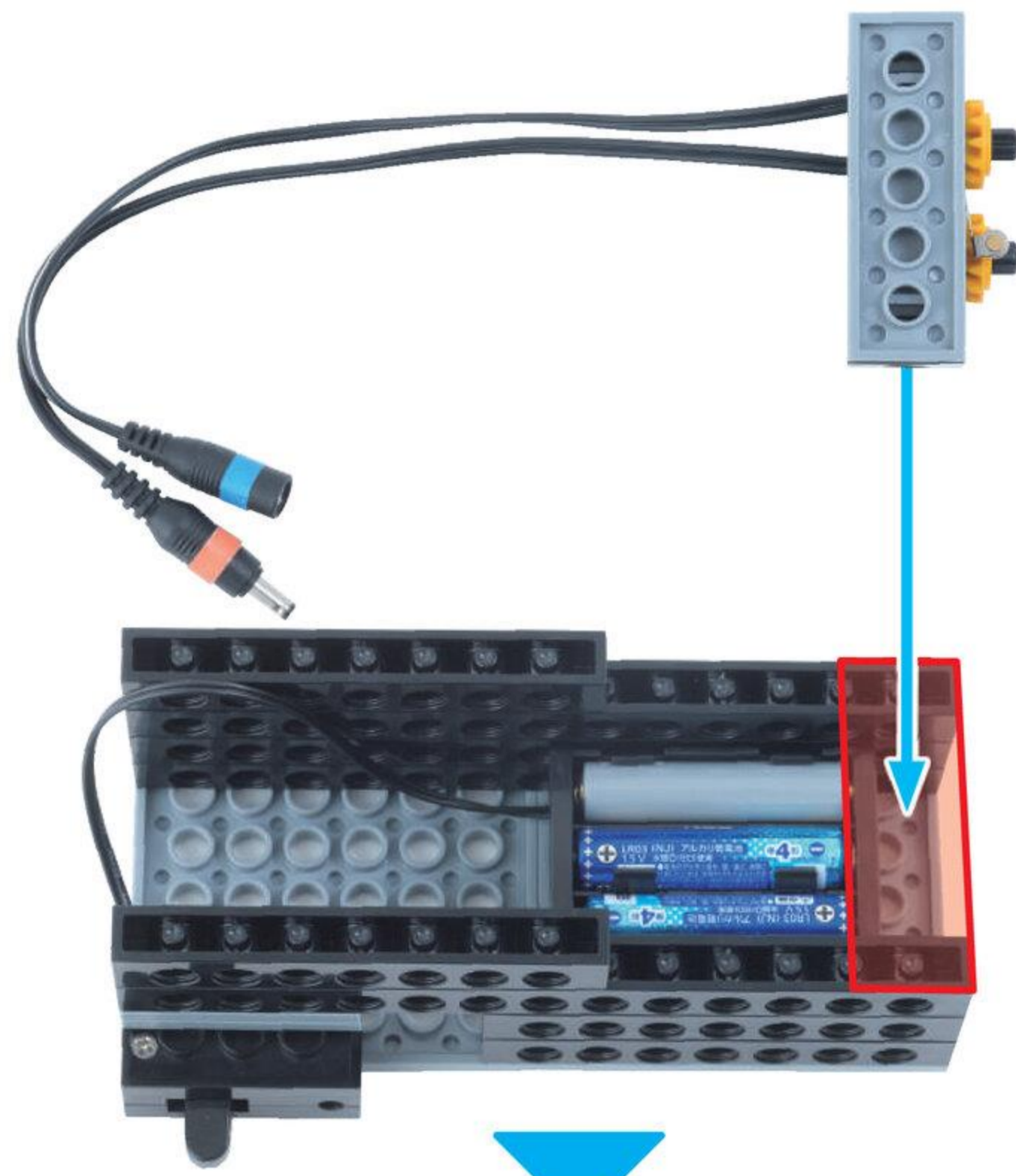

こねくた
だいだいのコネクタは
あなをとおしておこう

こおど
あおのコードは
そとがわに
だしておこう

びいむゆんぼち
ビーム 4 ポチ 2こ



ふとぶれえとろくぼち
太プレート 6 ポチ 1こ

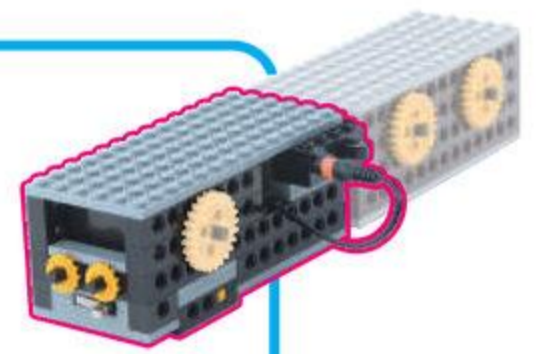

もおたあせつと
モーターセット



12

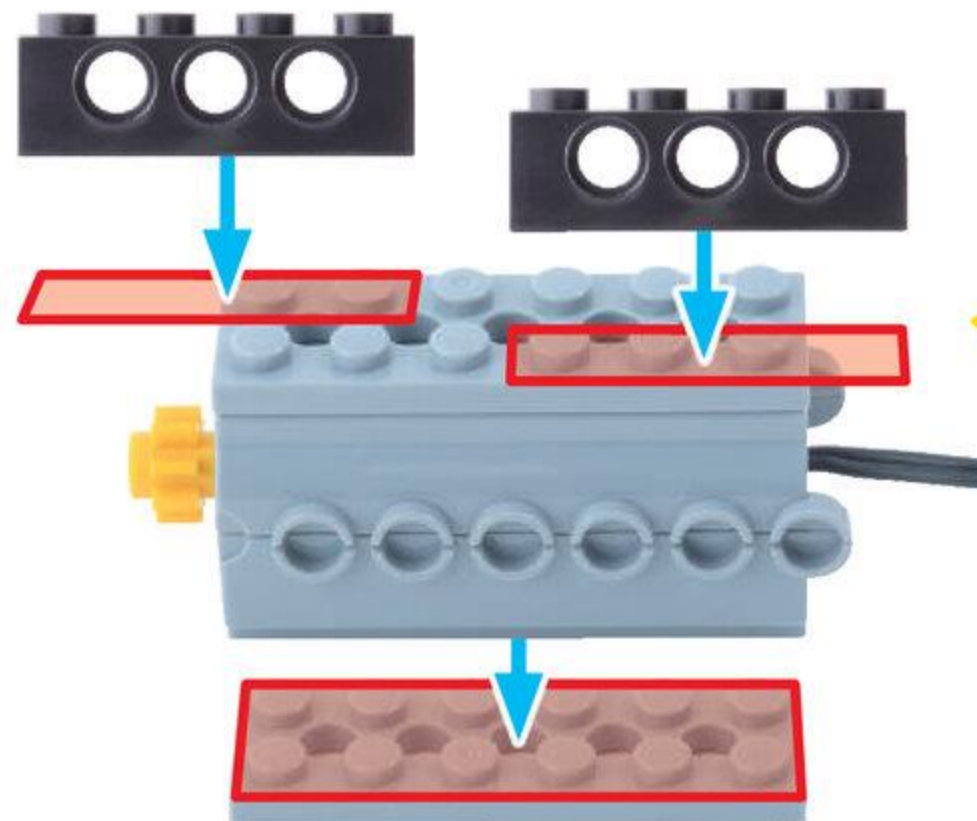

うえからみたところ

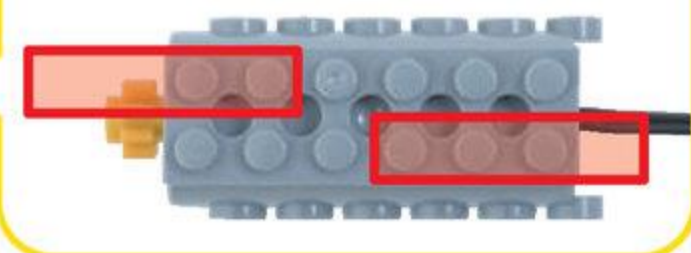

くみたてた
ばあつ
パーツを
うらがえすよ

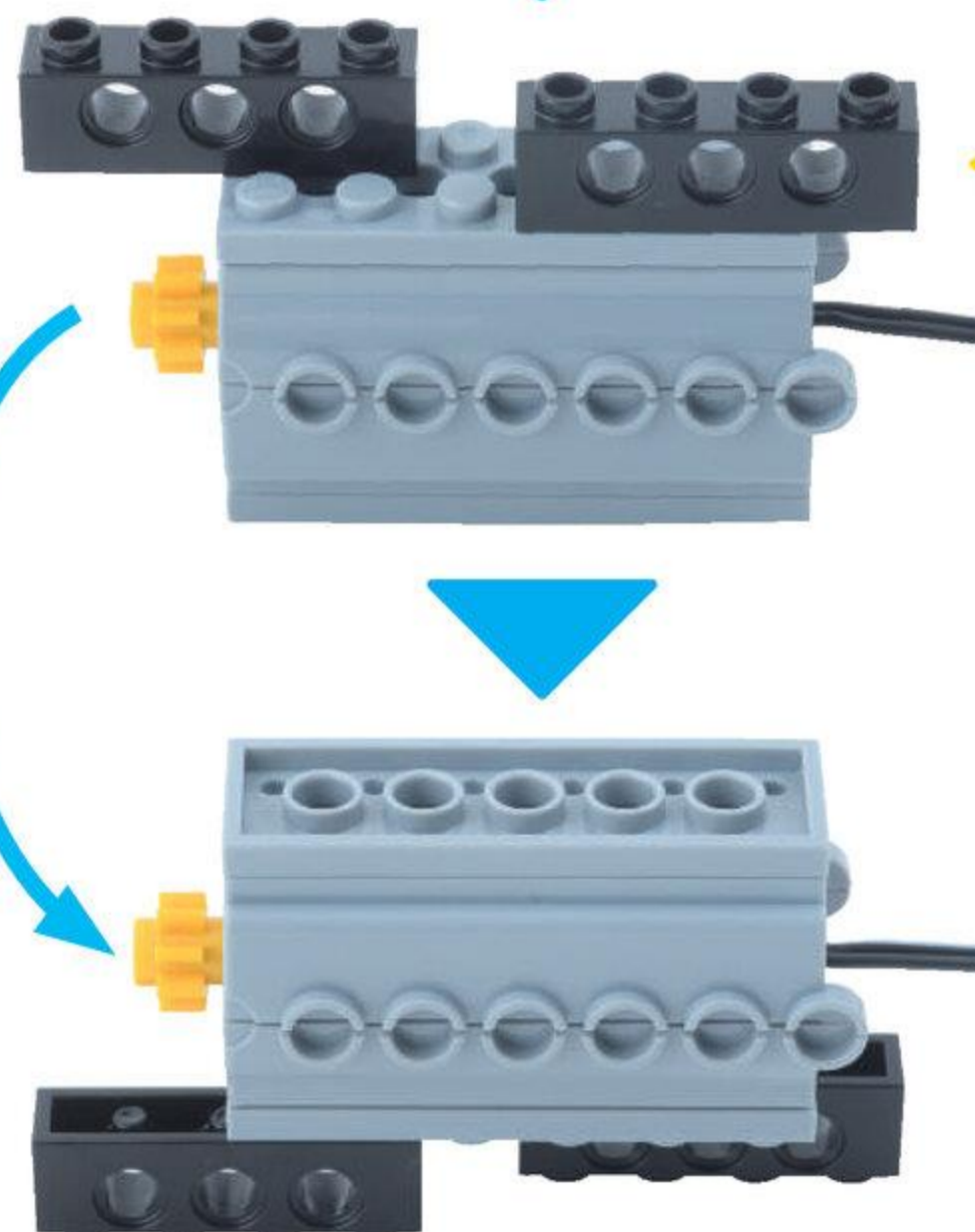
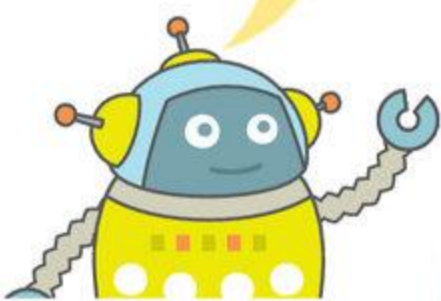

うえからみたところ

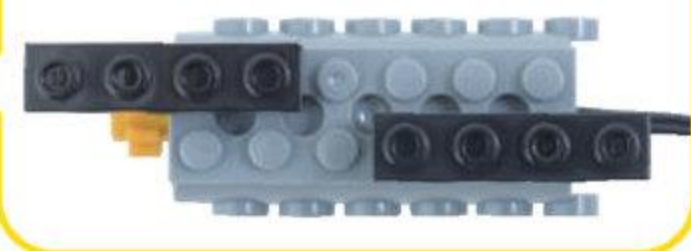

13

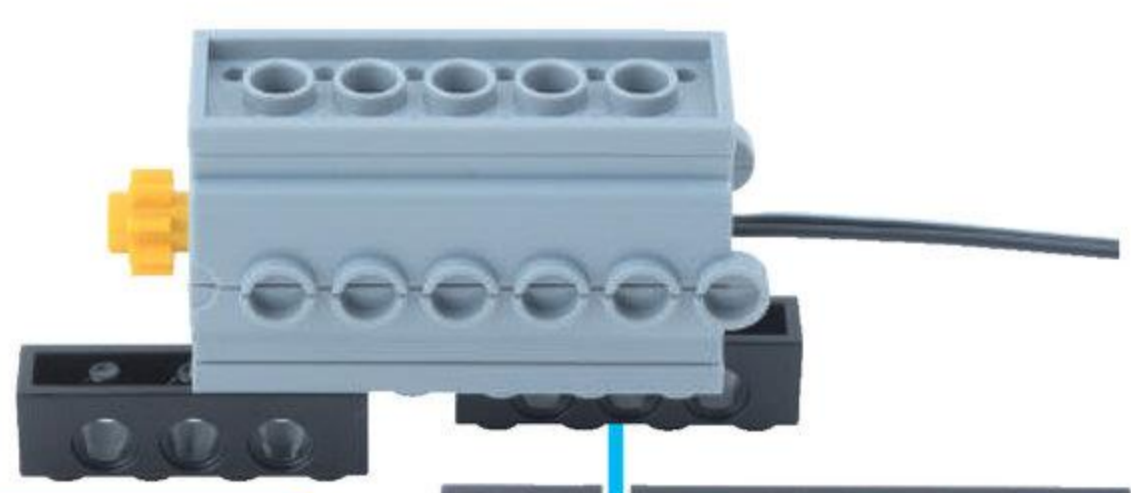
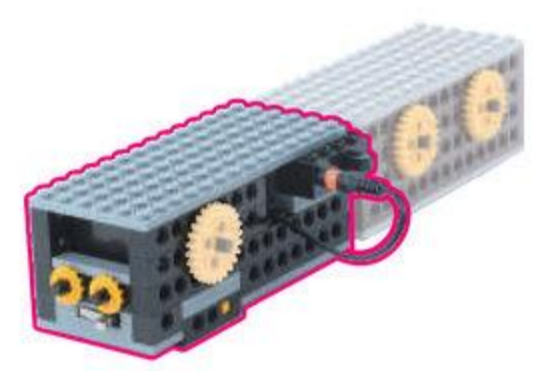

びいむよんぼち
ビーム 4 ポチをはめる
いちをかくにんしよう

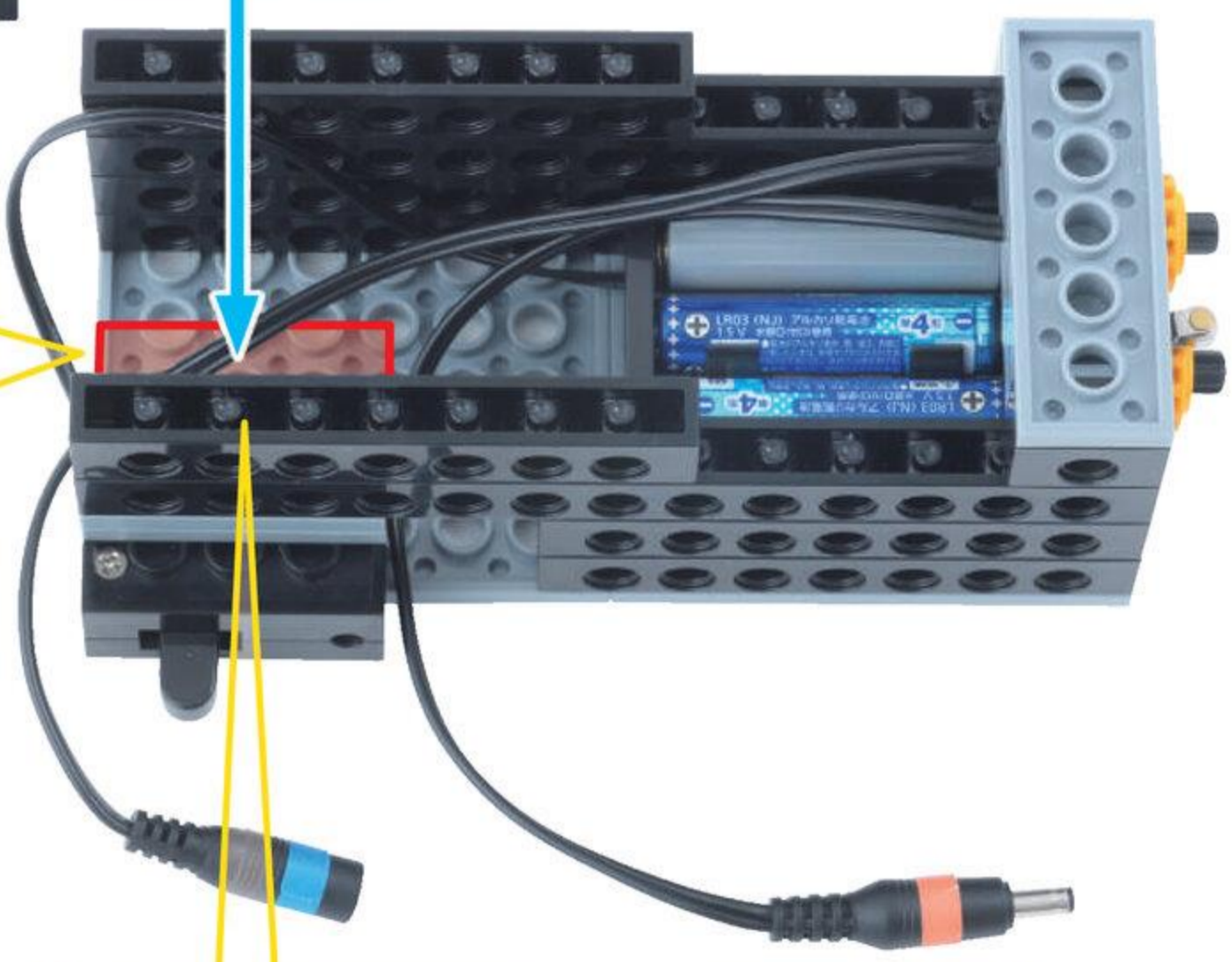

こおど
コードを
はさまないように
ちゅういしよう

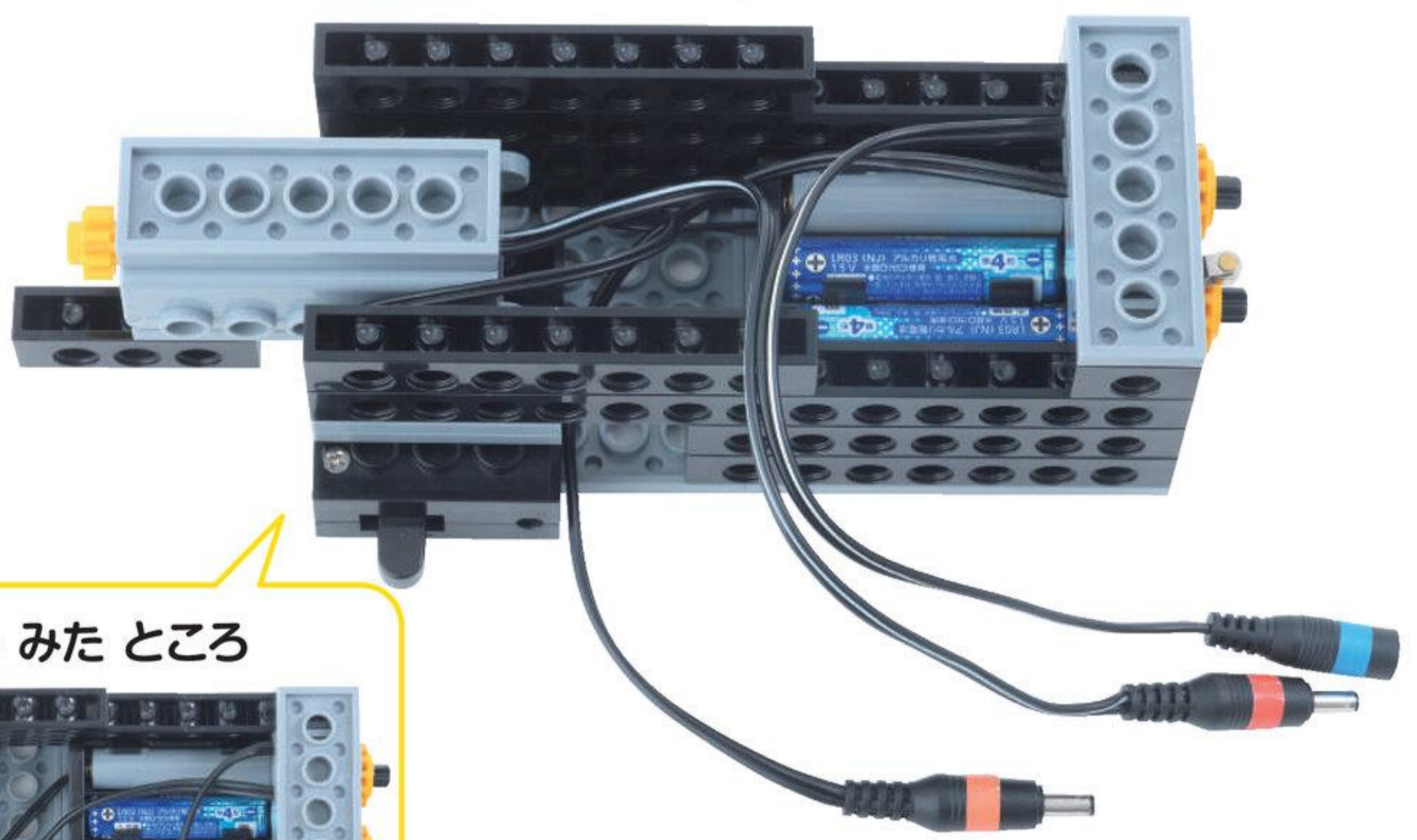

うえからみたところ

14

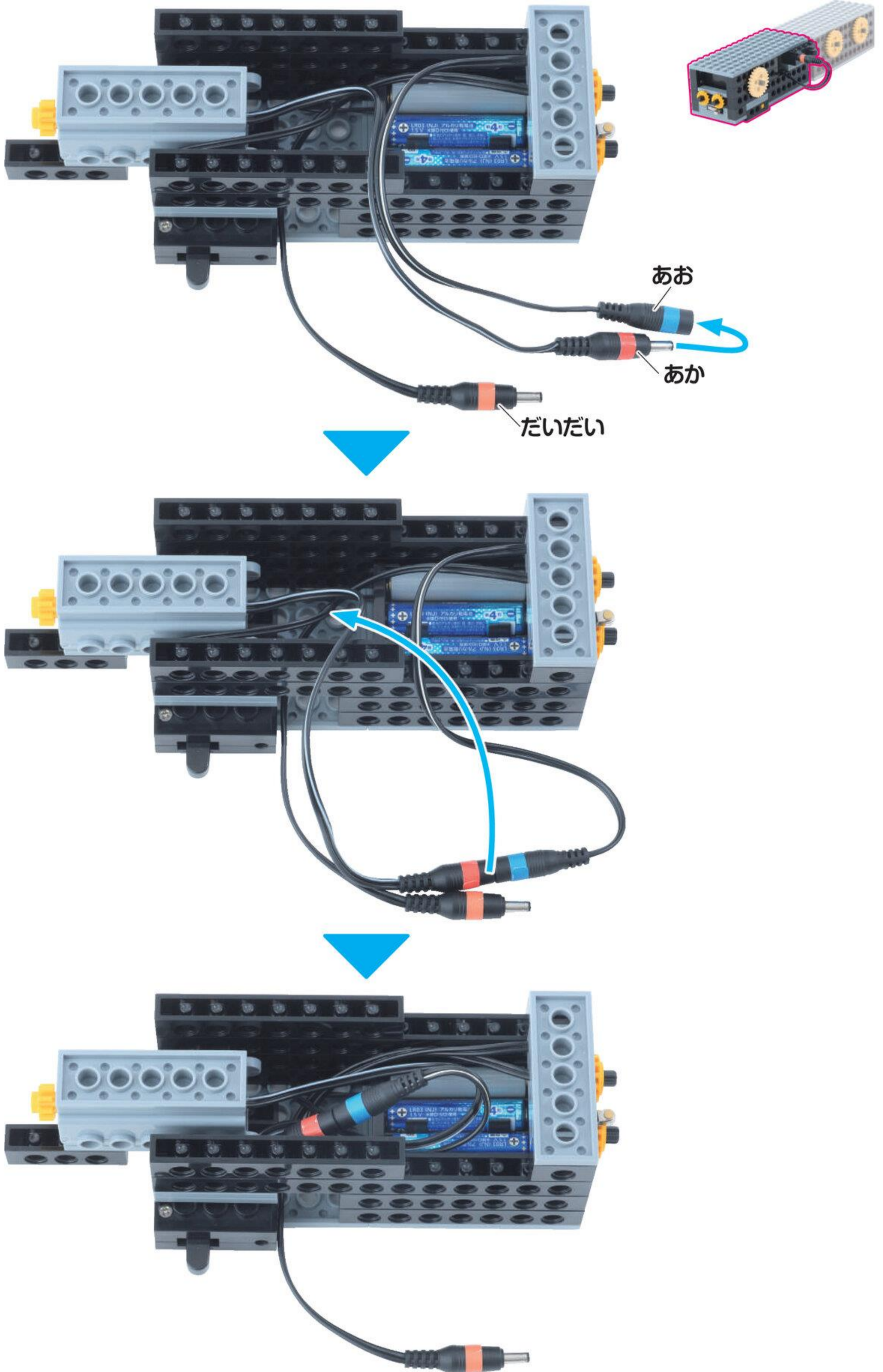

しゃふとろくほち
シャフト 6 ポチ 1こ



ぐろめつと
グロメット 4こ



ぶっしゅ
ブッシュ 4こ

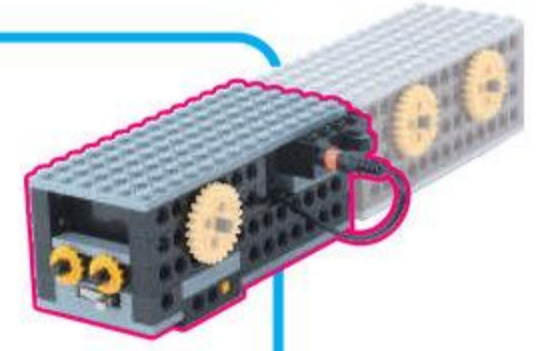

15



びいむ ん ぼち
ビーム 4 ポチ 2 こ



ほそぶ れ え と ん ぼち
細プレート 4 ポチ 2 こ

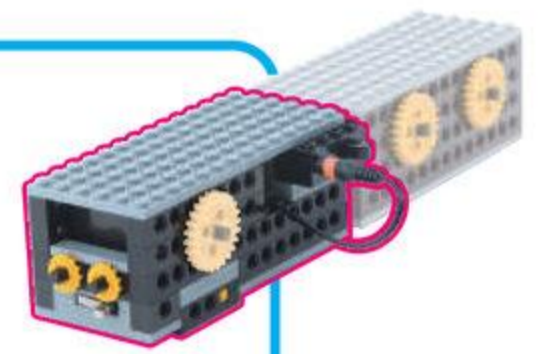

16

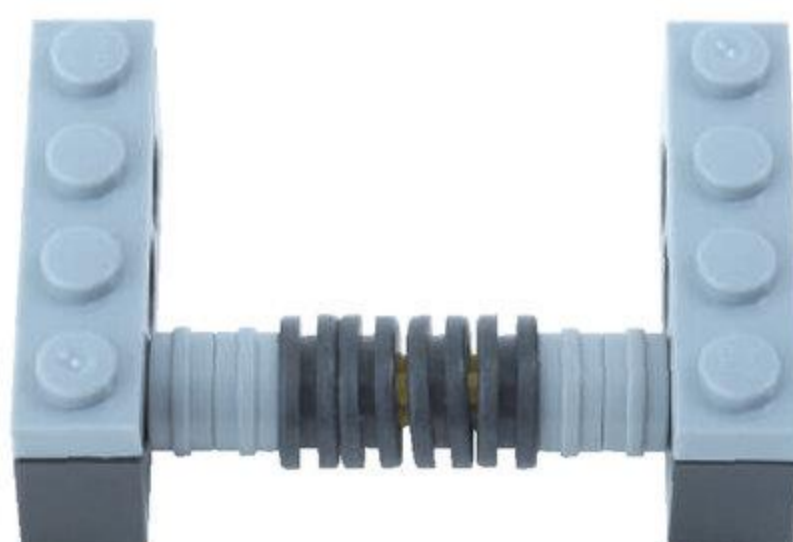
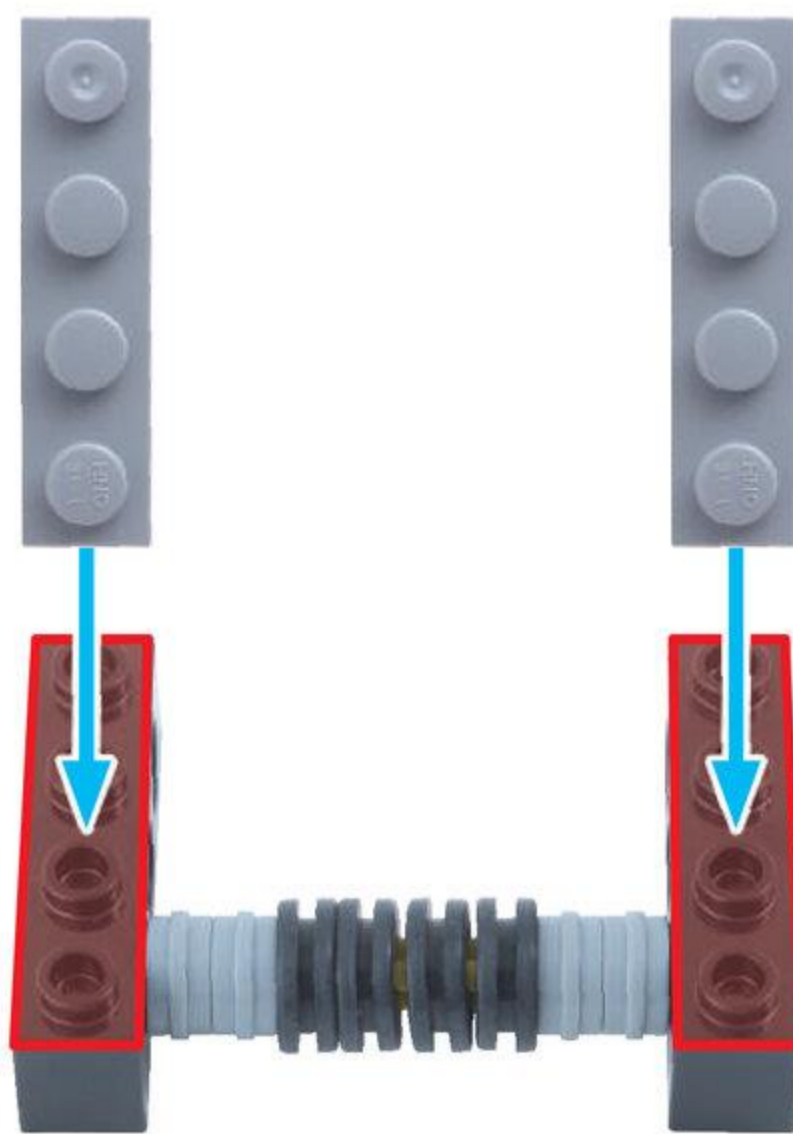

ふとぶれえとろくほち
太プレート 6 ポチ 1 こ



ほそぶれえとほち
細プレート 2 ポチ 2 こ

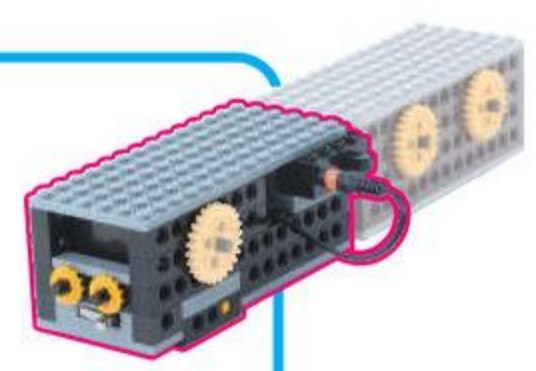

17

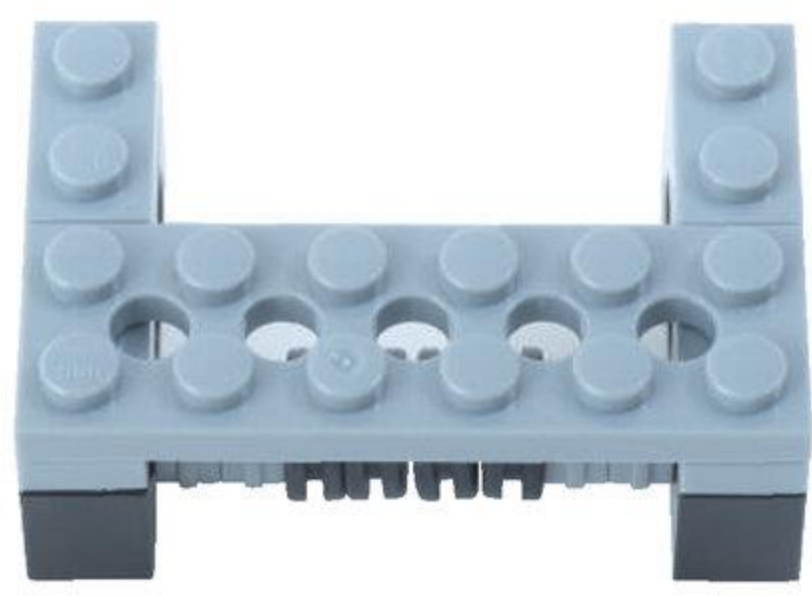
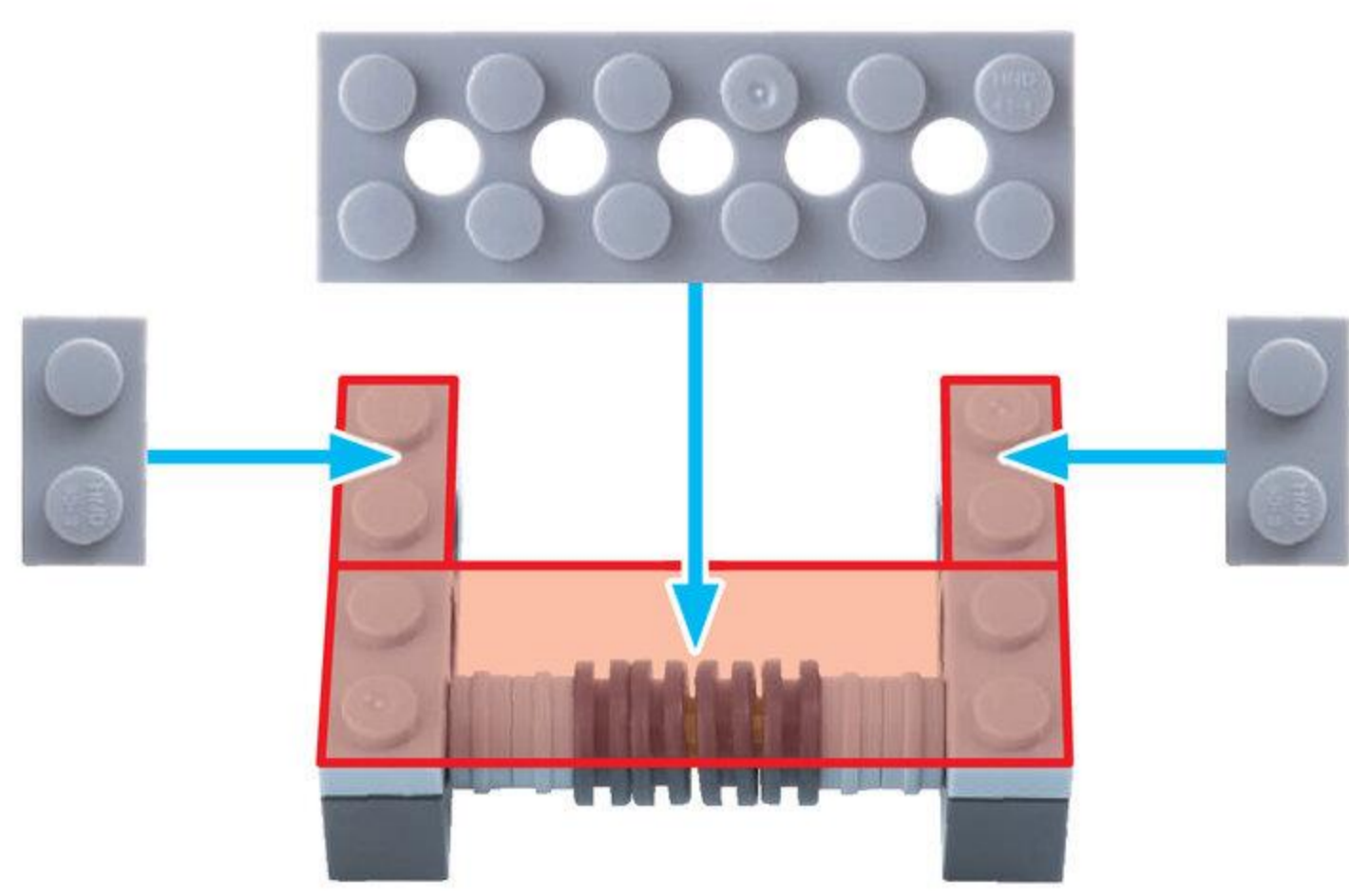

くみたてた^{ばあつ}パーツを
うらがえすよ

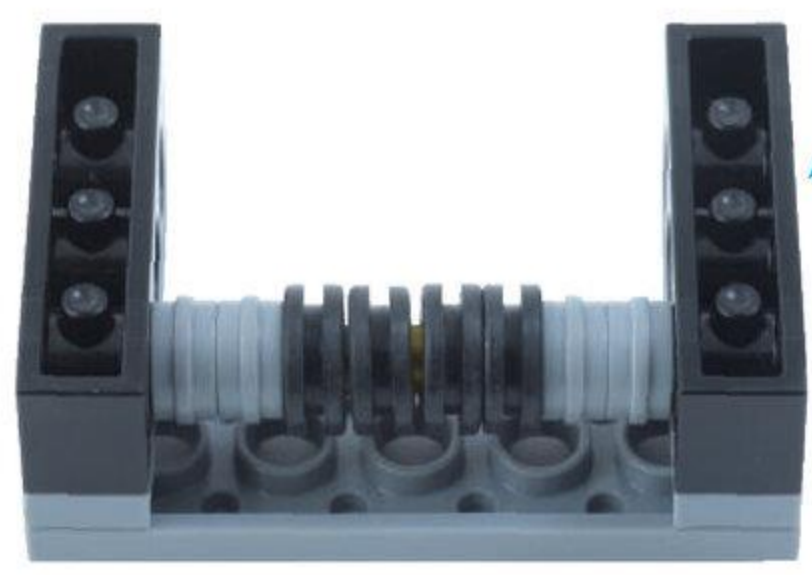
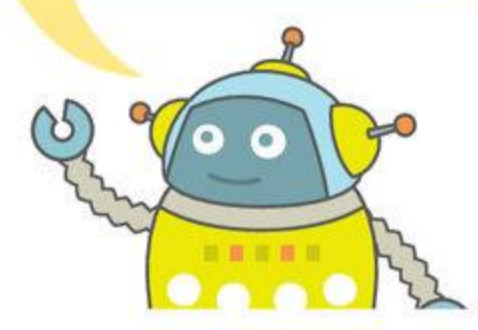

18

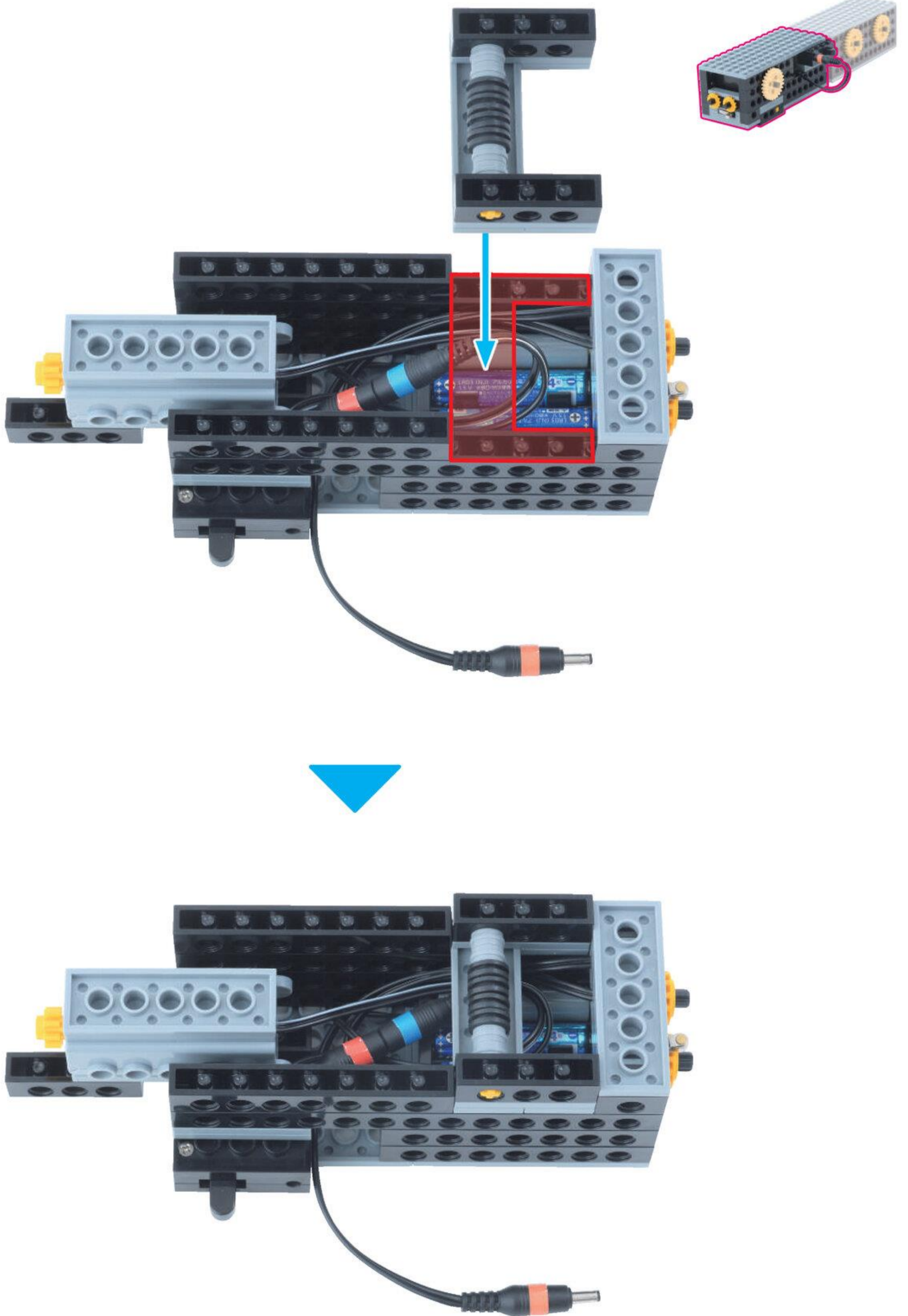

ぶれえとる プレート L1 **1**こ

うら

ほそぶれえといちほち 細プレート 1ポチ **2**こ

うら

19

うらがえして おこ

うらがえして おこ

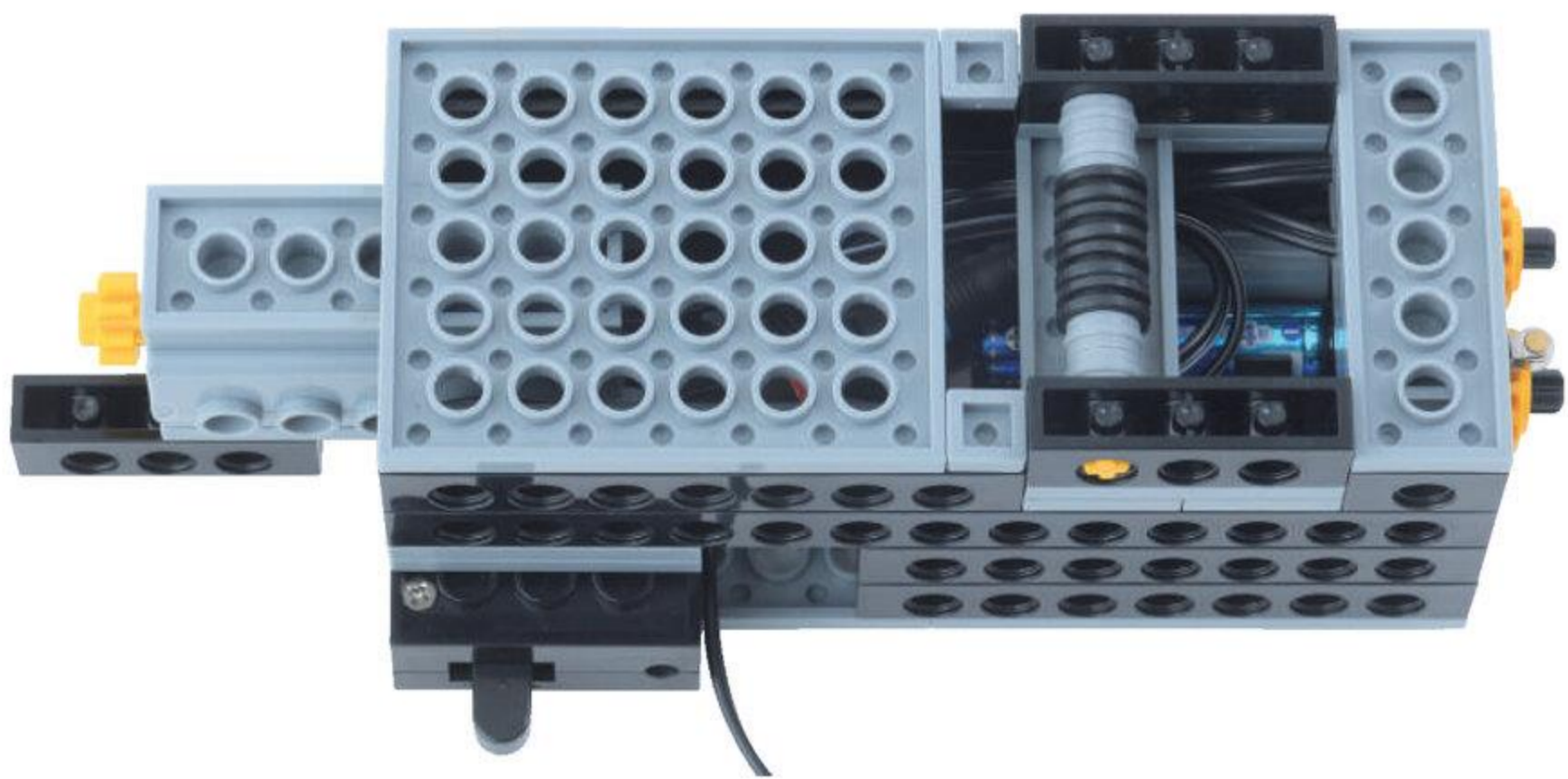
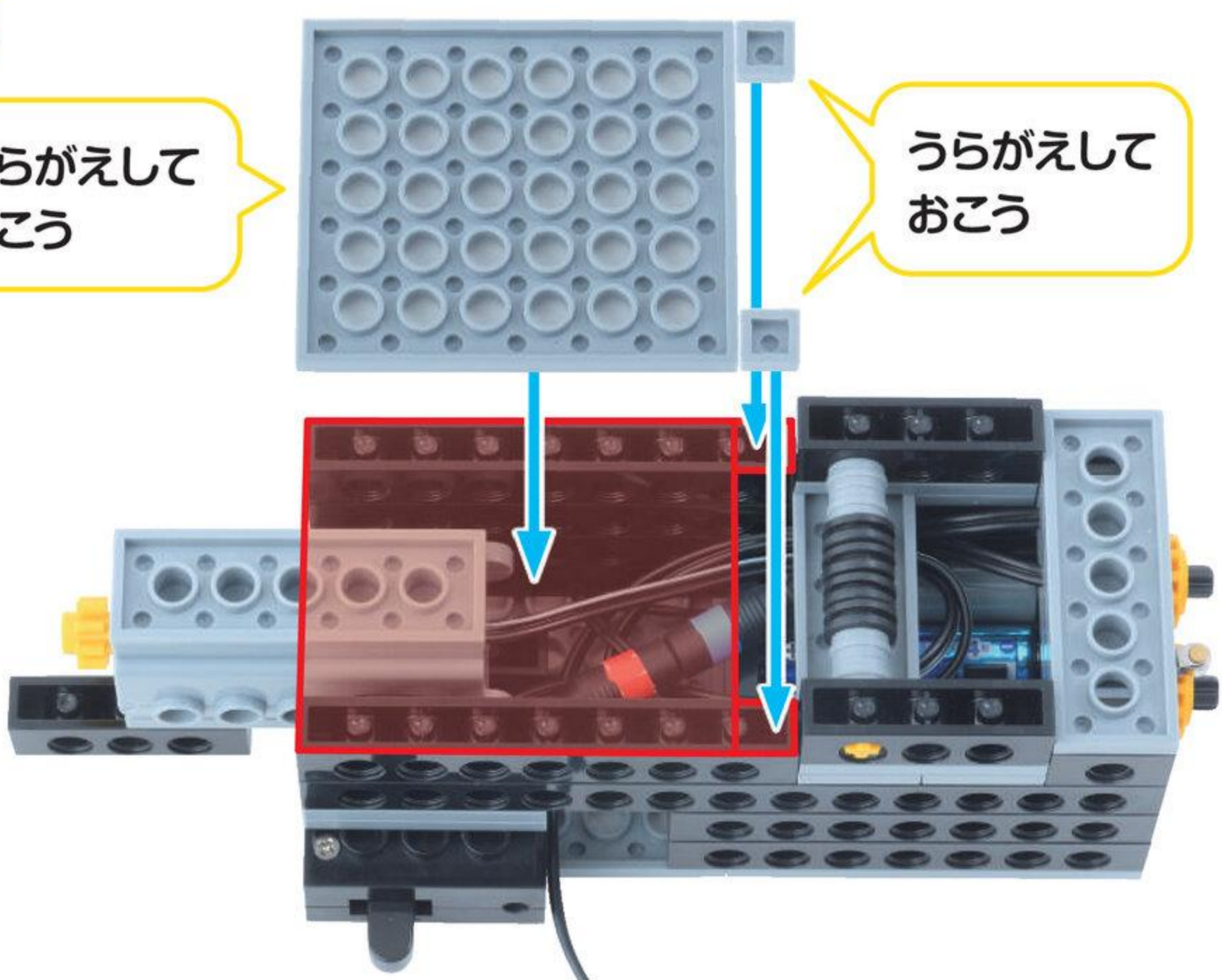

まえの しゃりょうが かんせい!

やったね!

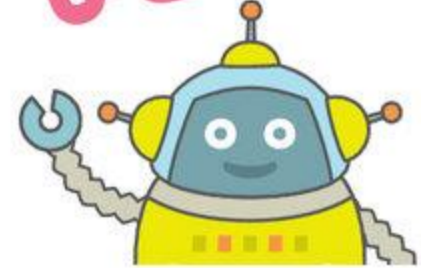

2 うしろのしゃりょう

めやす 15 ぶん

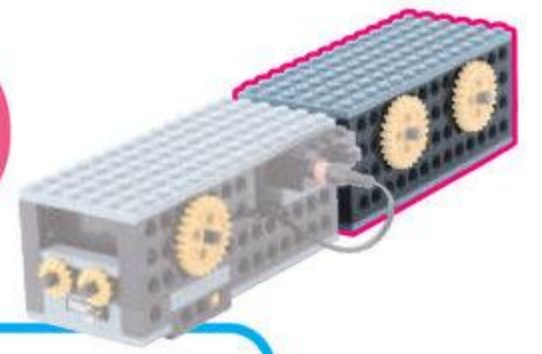

びいむじゅうんほち
ビーム 14 ポチ 4 こ



1

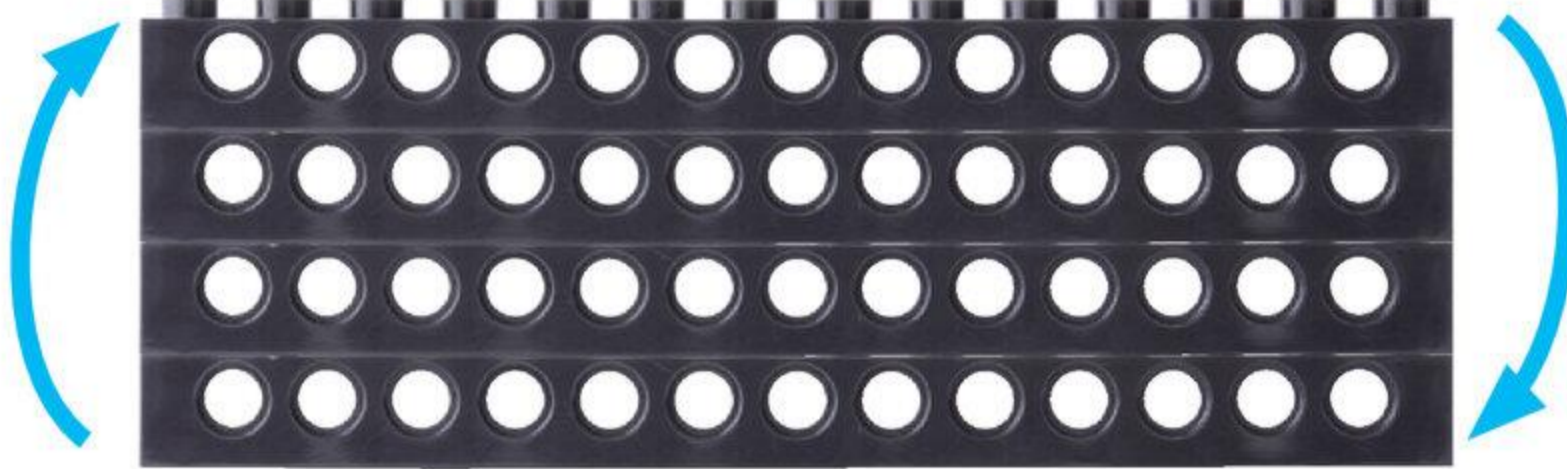

くみたてたパーツを
じょうげぎやくに
するよ

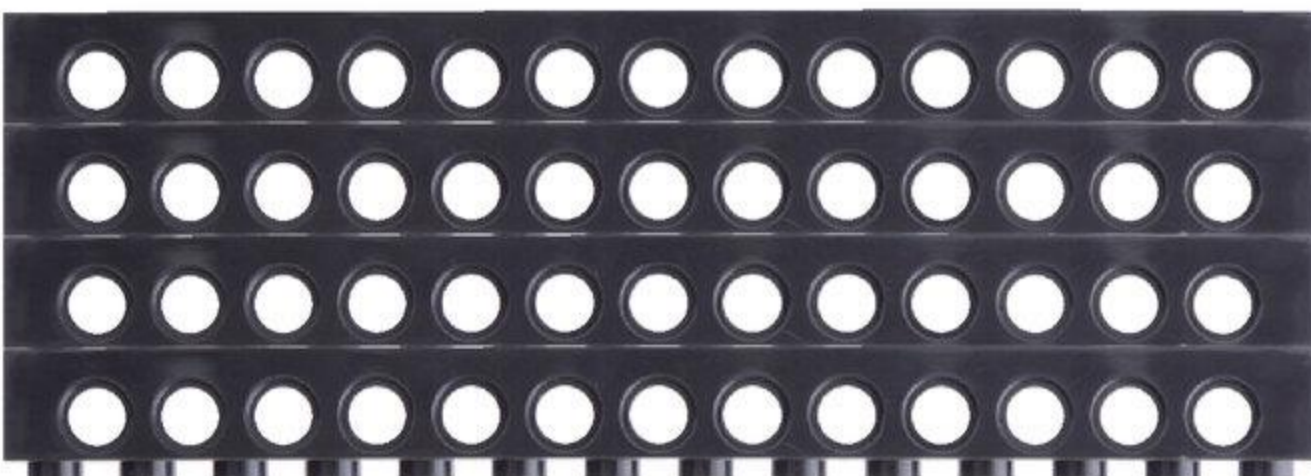
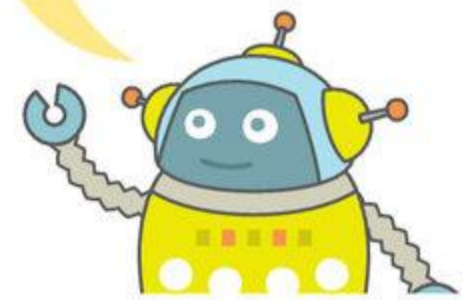

ぶれえとろ
プレートL 2こ

うら

2

うらがえしておこう

ながさに ちゅうい
ながい

みじから

しゃふとペグ
シャフトペグ 1こ



びにおんぎあ
ピニオンギアうす 1こ

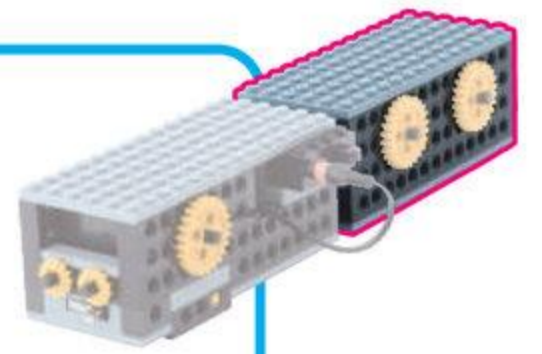

3

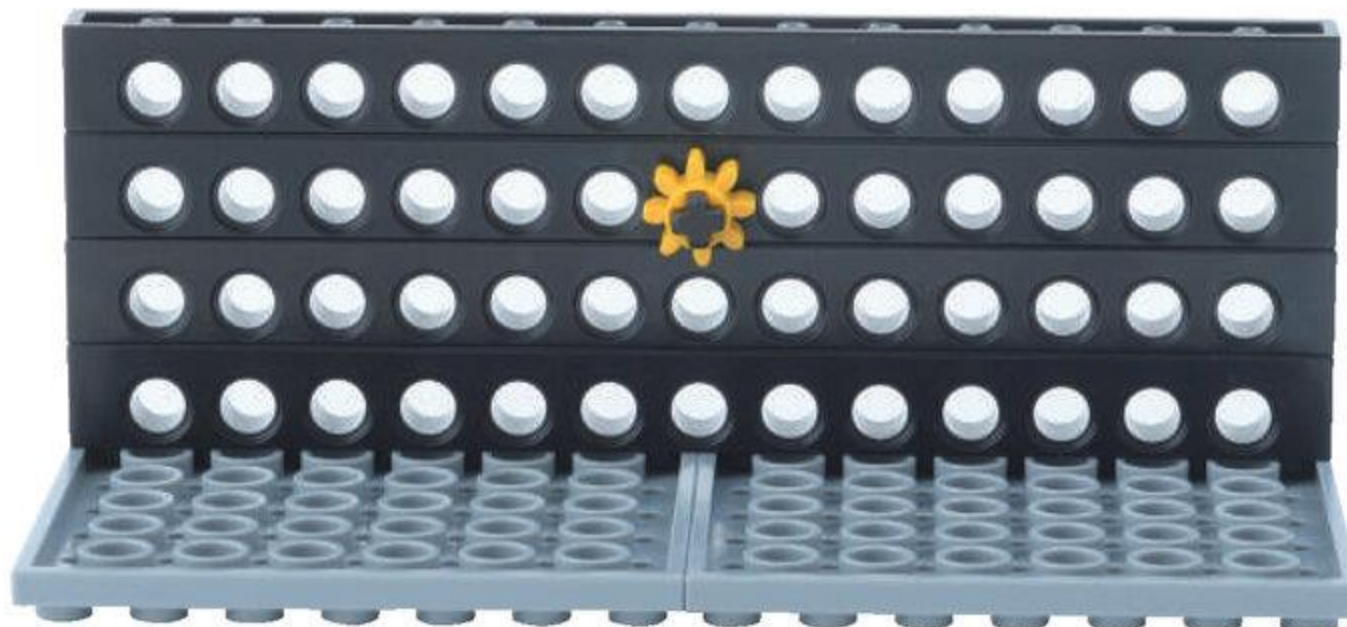
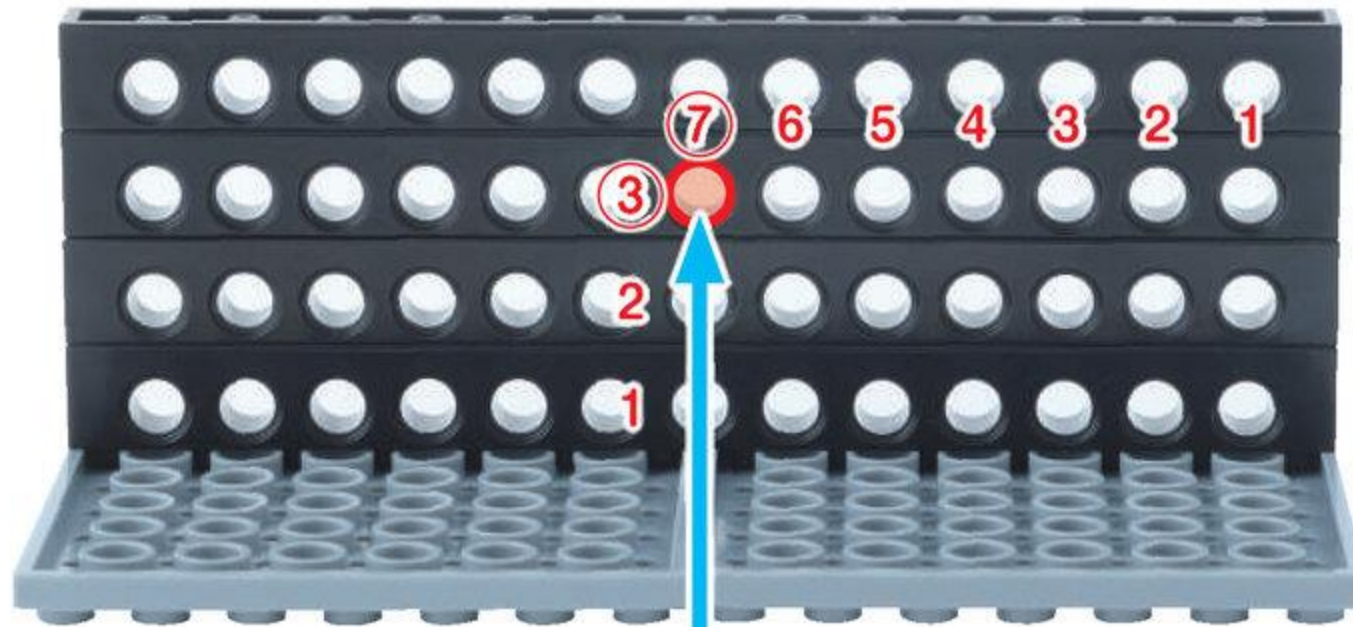

しゃふとろくほち
シャフト 6 ポチ 1こ

ぎあえる
ギア L 1こ

たいやえる
タイヤ L 1こ

ぶっしゅ
ブッシュ 1こ

4

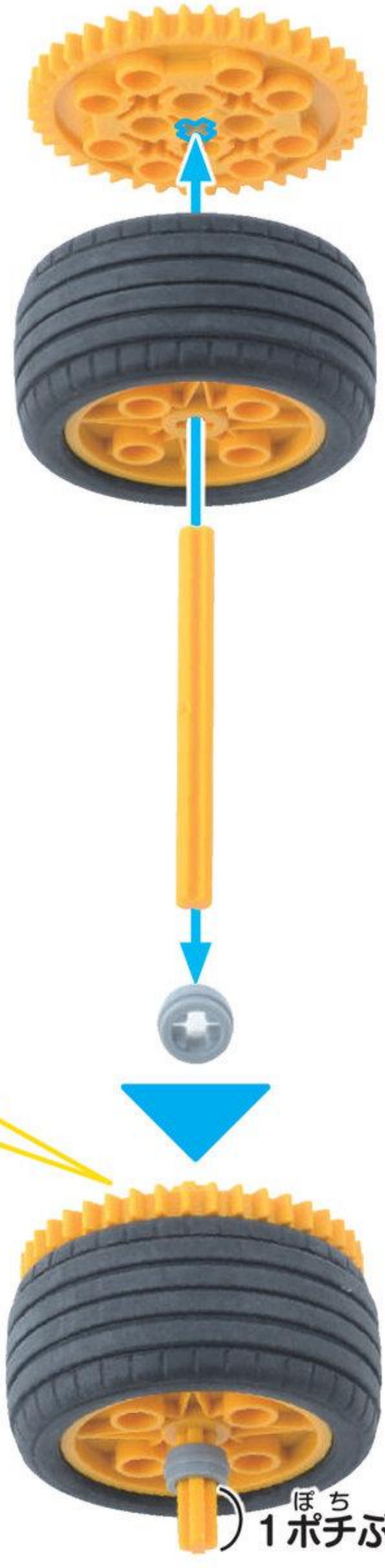

ぎあえる
ギア L がわは
しゃふとろくほち
シャフト 6 ポチが
ほち
1 ポチぶん でているよ

ほち
1 ポチぶん

5

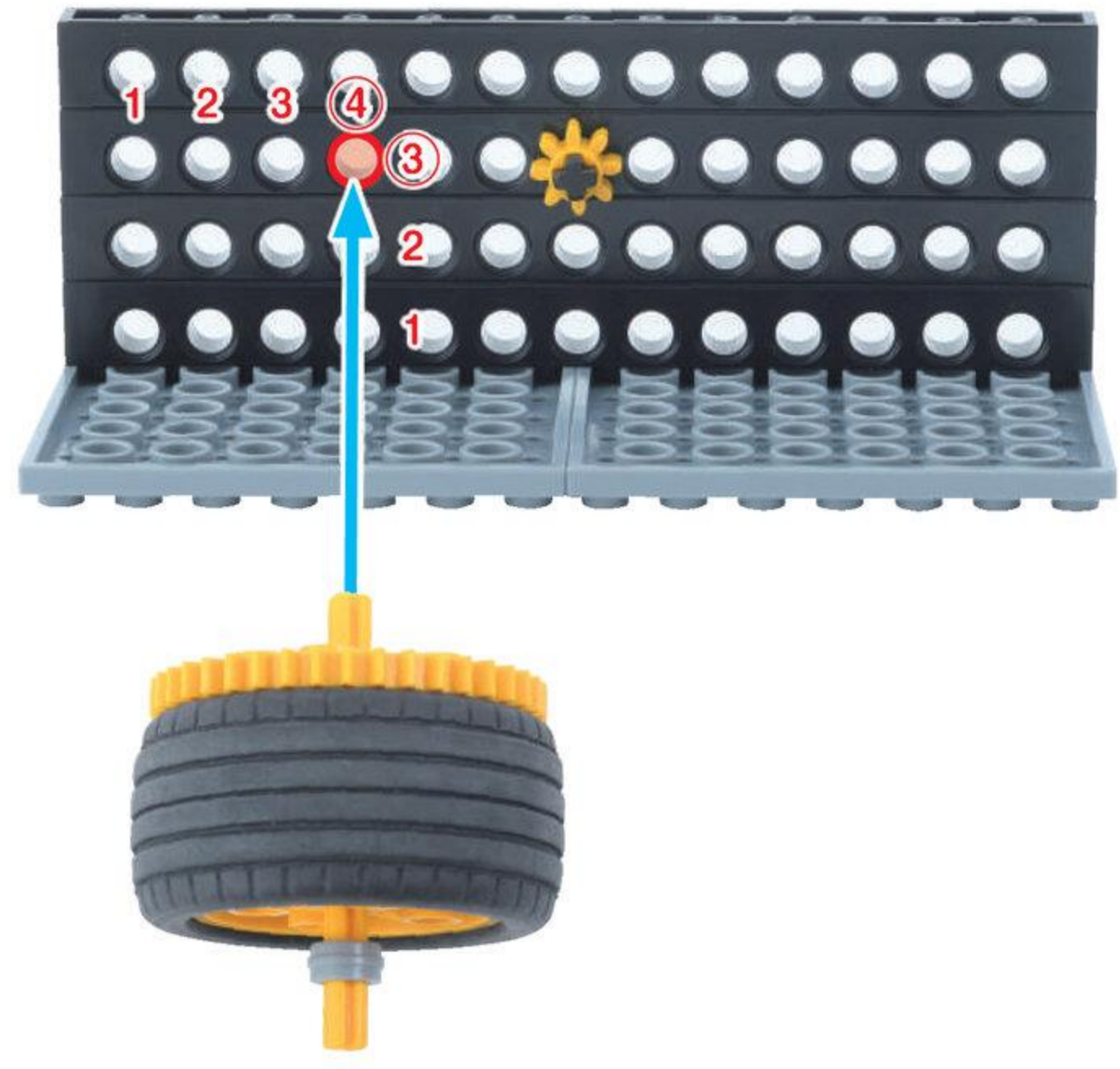
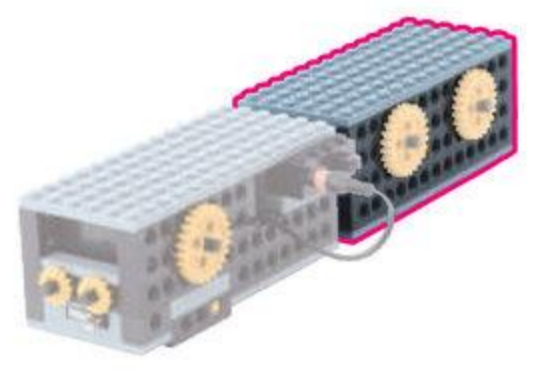

しゃふとろくぼち
シャフト 6 ポチ 1 こ

ぎあえむ
ギア M うす 1 こ

ぴにおんぎあ
ピニオンギア うす 1 こ

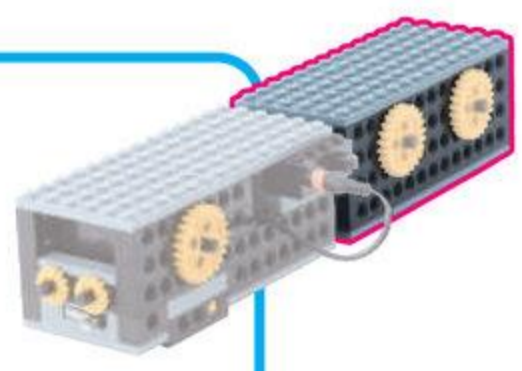

6

ぼち 1 ポチぶん

ぼち 1 ポチぶん

びいむ
ビームを つかっ て あけ る こ と も で き る よ !

ギアセットと
ギアセット

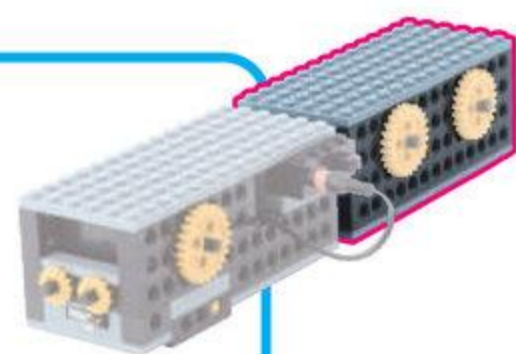

7

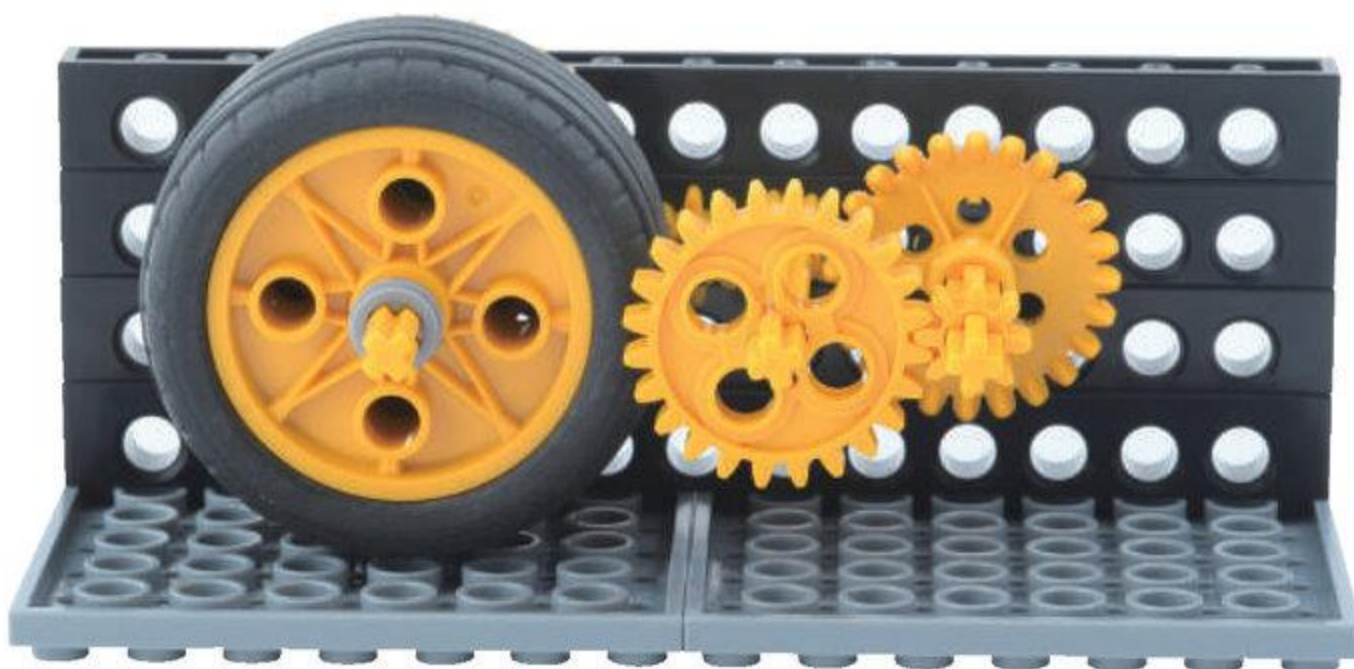
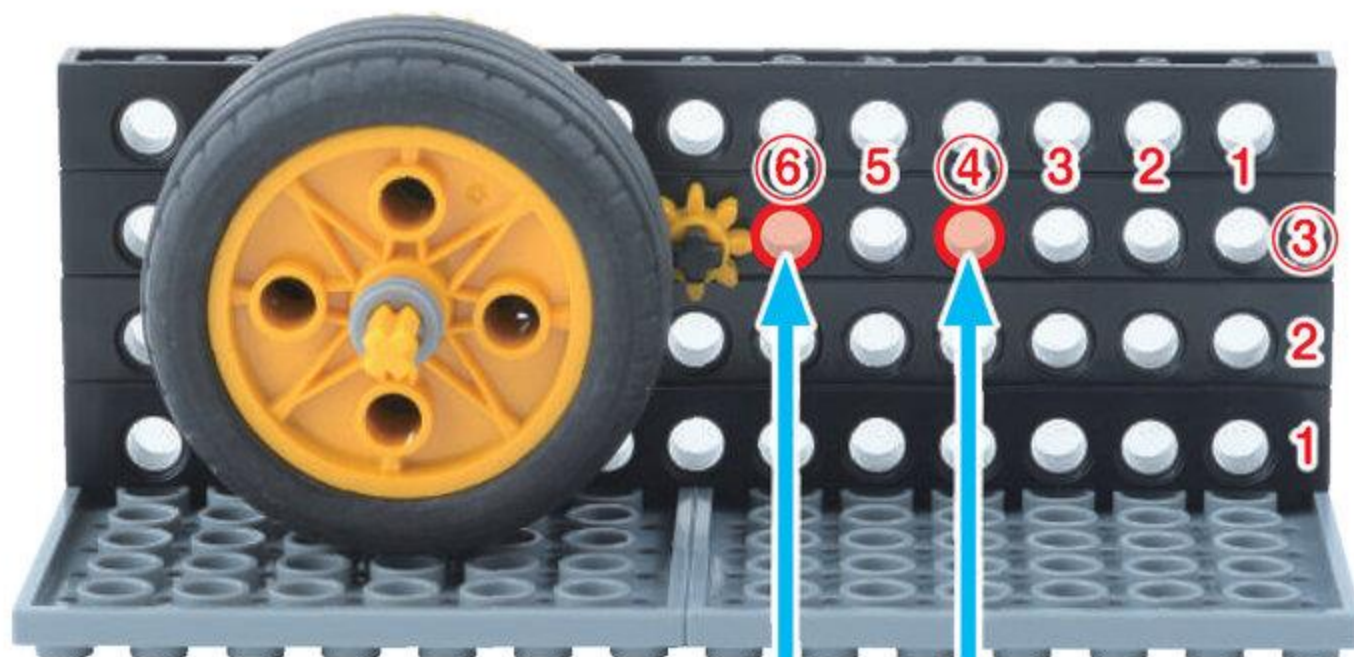

びいむじゅうよんぼち
ビーム 14 ポチ **2**こ

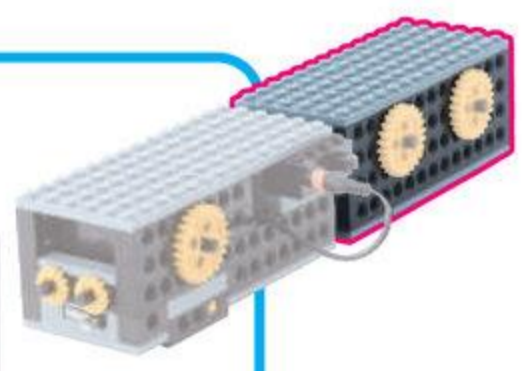

8

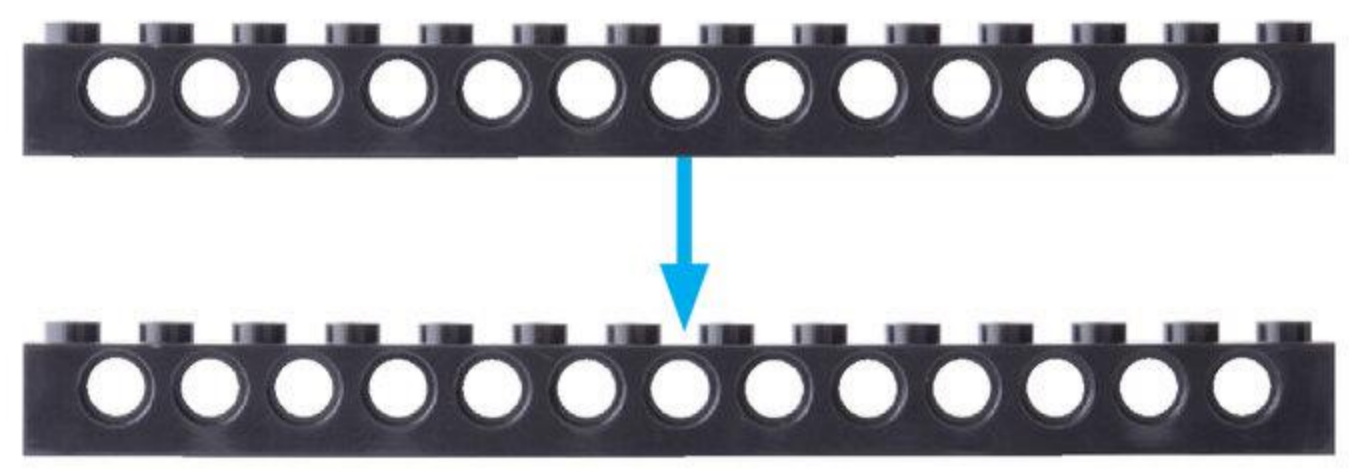

くみたてた^{ぼあつ}パーツを
じょうげ ぎやくに
するよ

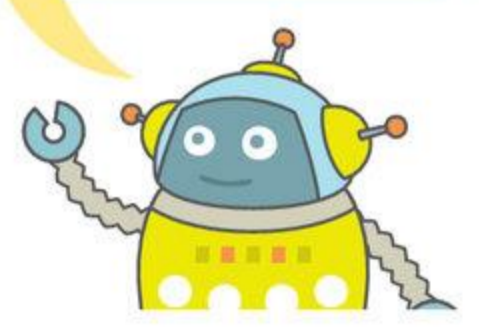

9

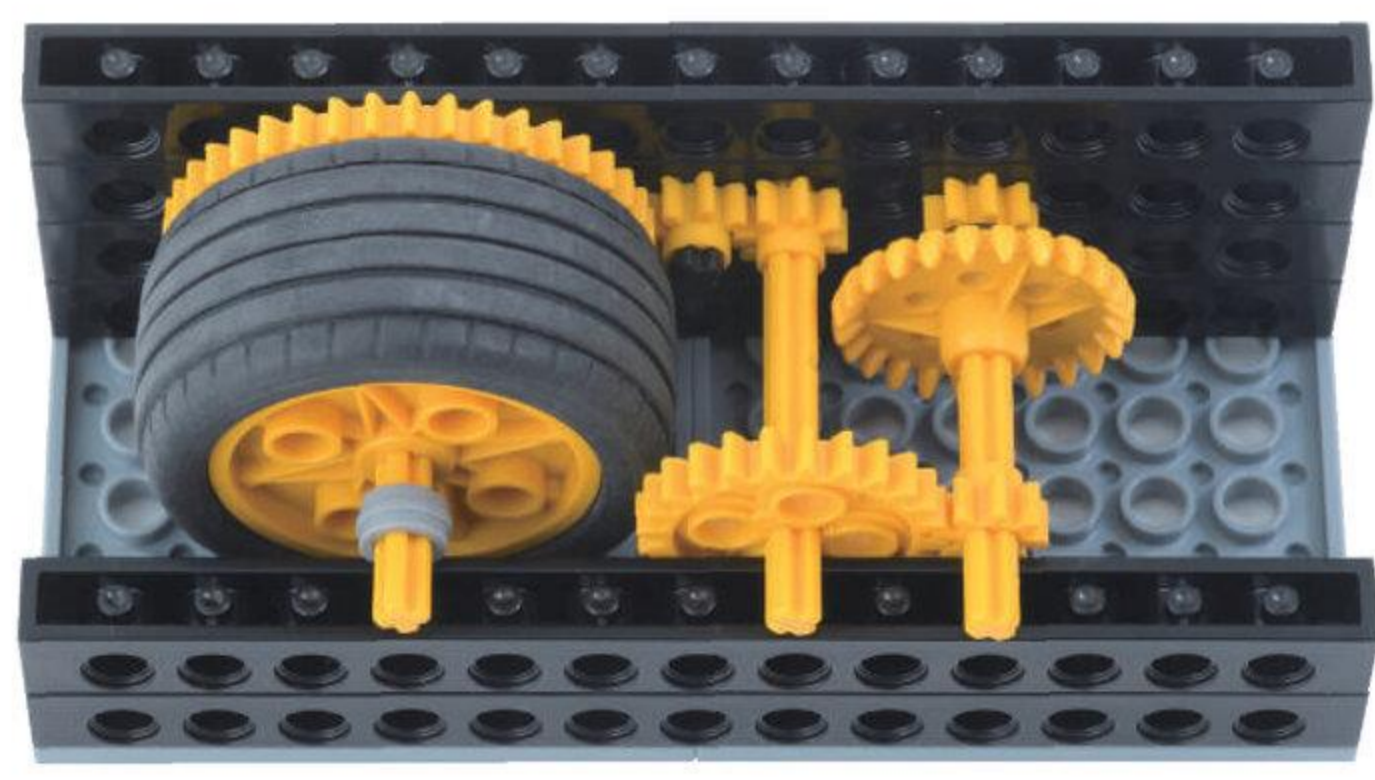
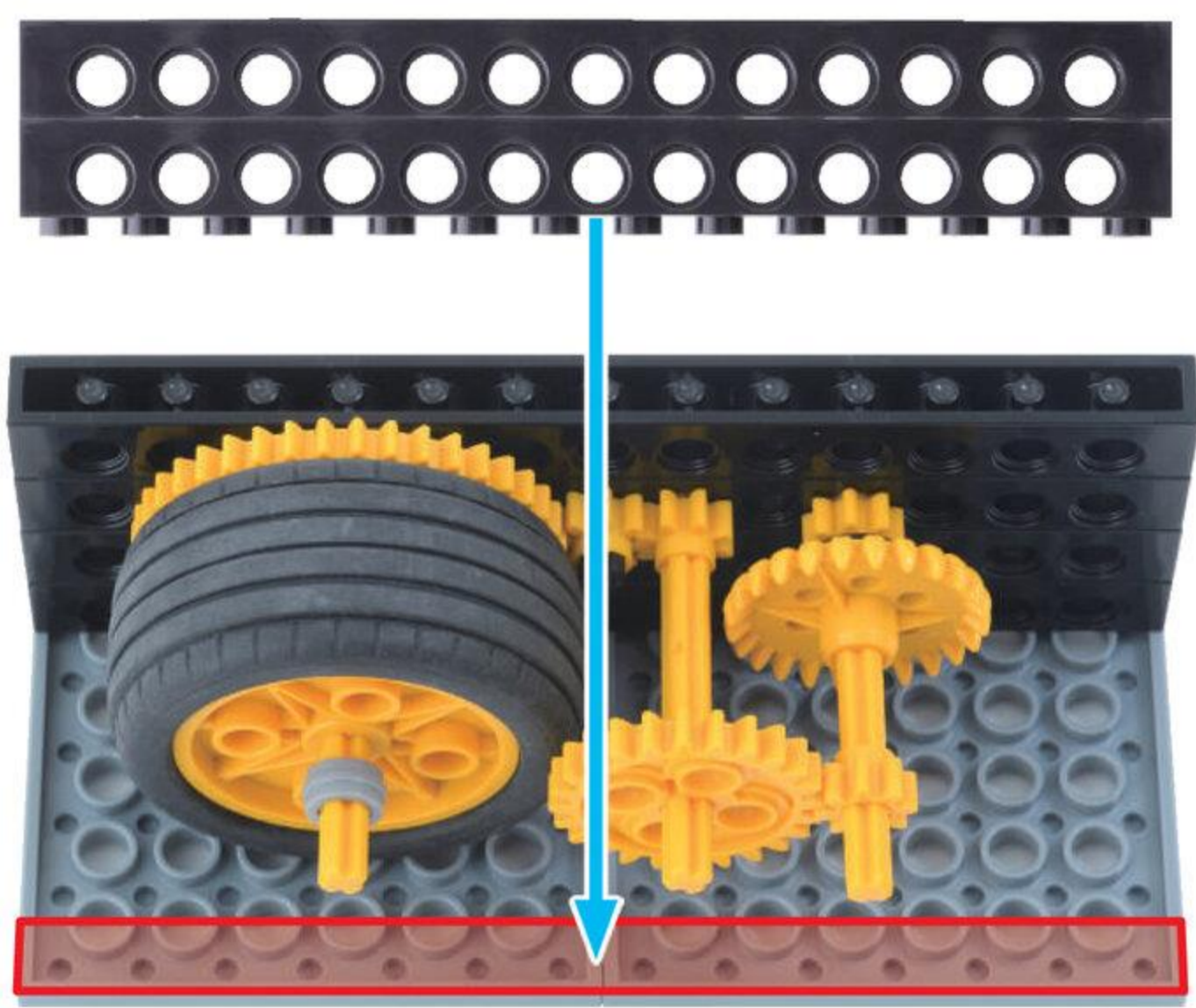
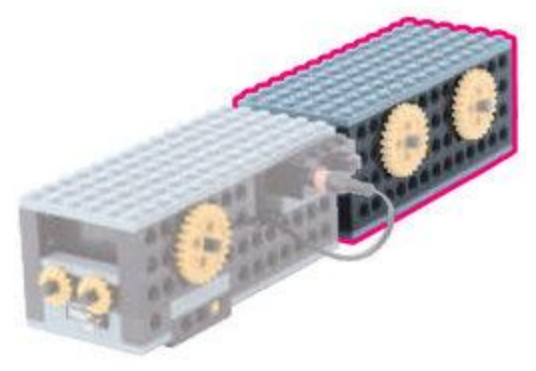

びいむじゅうよんぼち
ビーム 14 ポチ 2こ

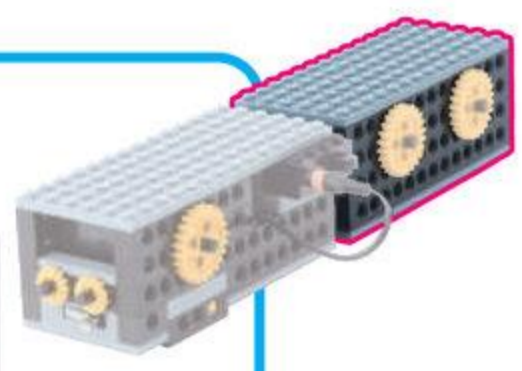

10

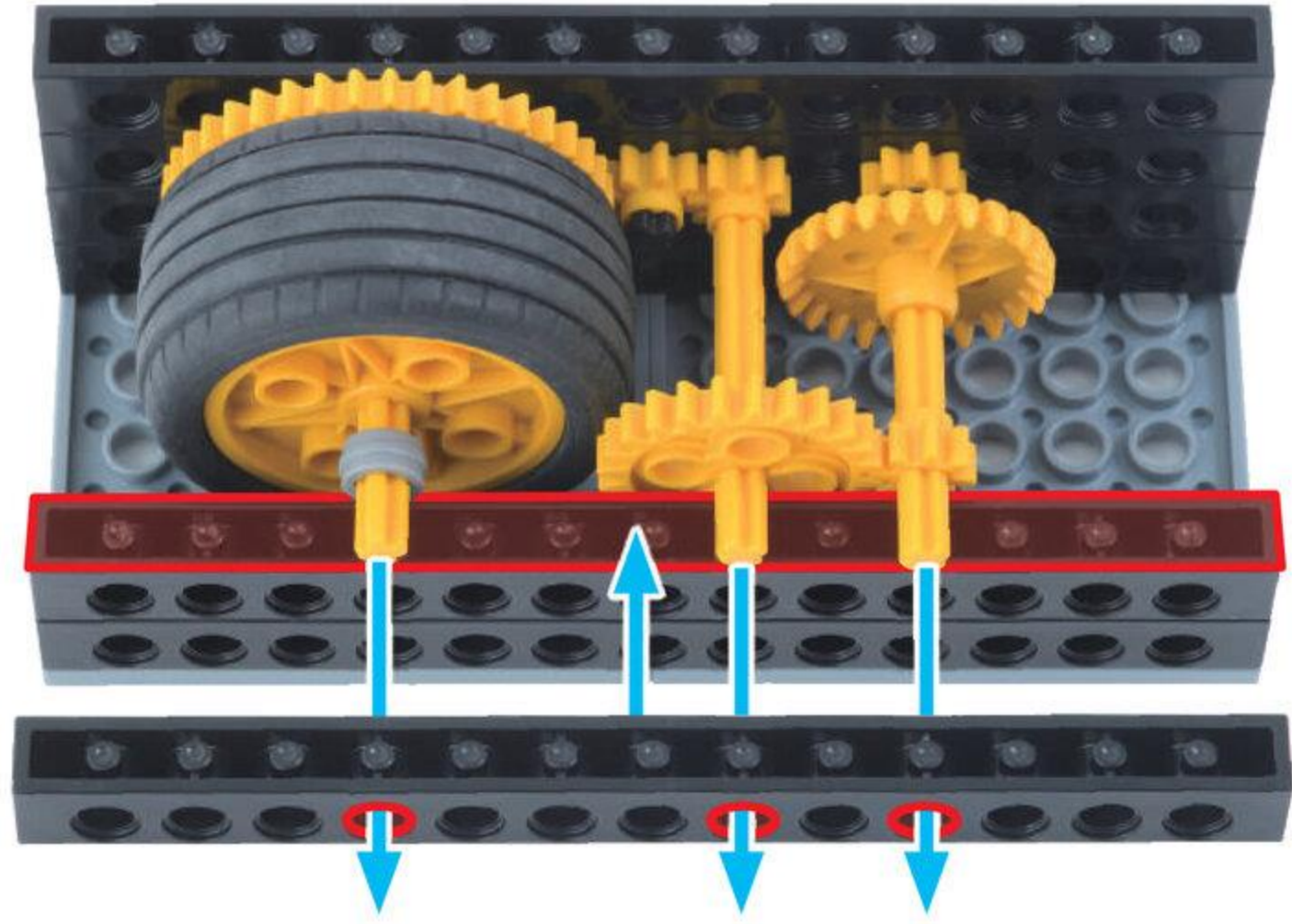

うらがえして
おこそう

うらがえして
おこそう

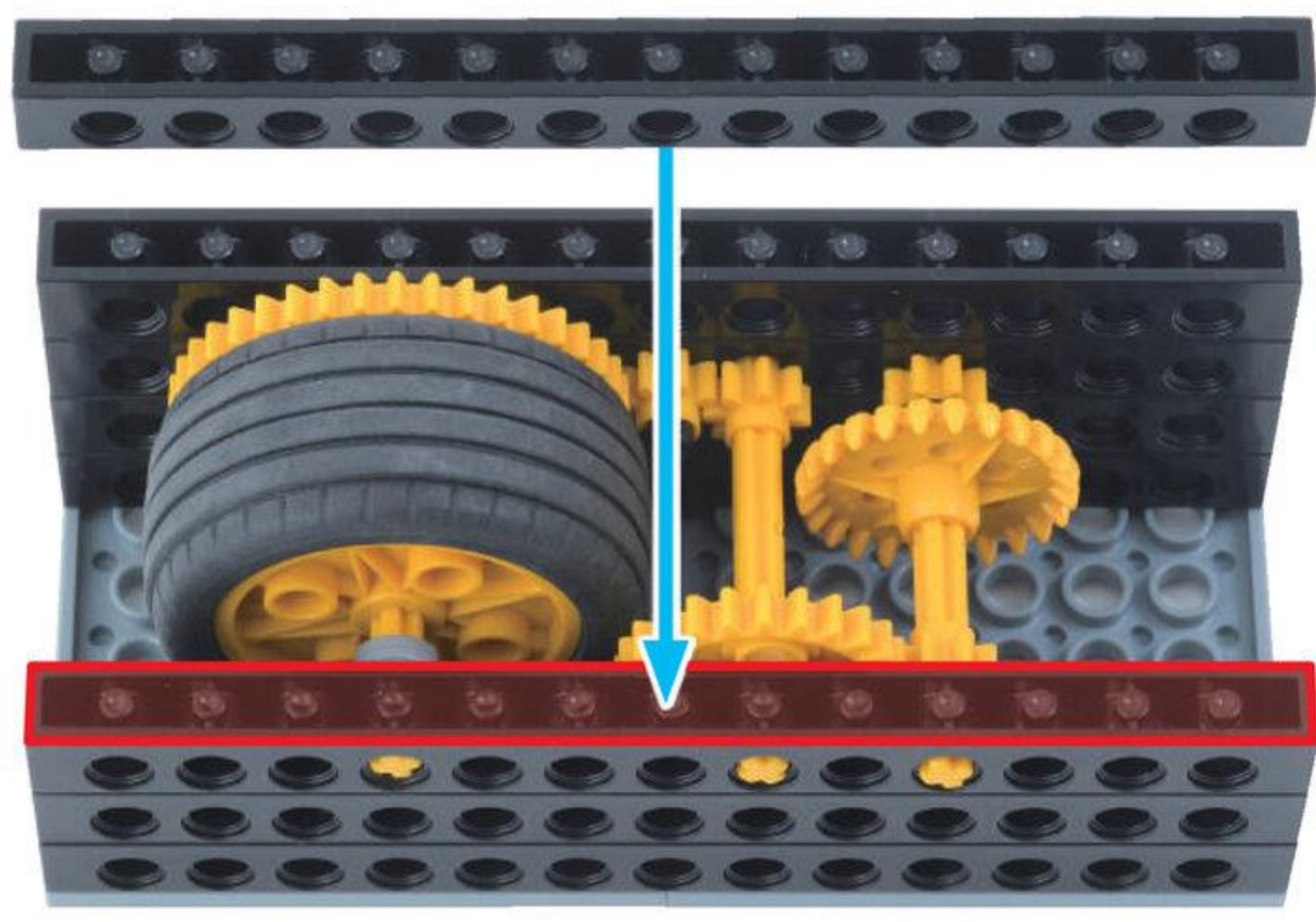

ぎあ
ギアが かみあっているか
かくにんしよう

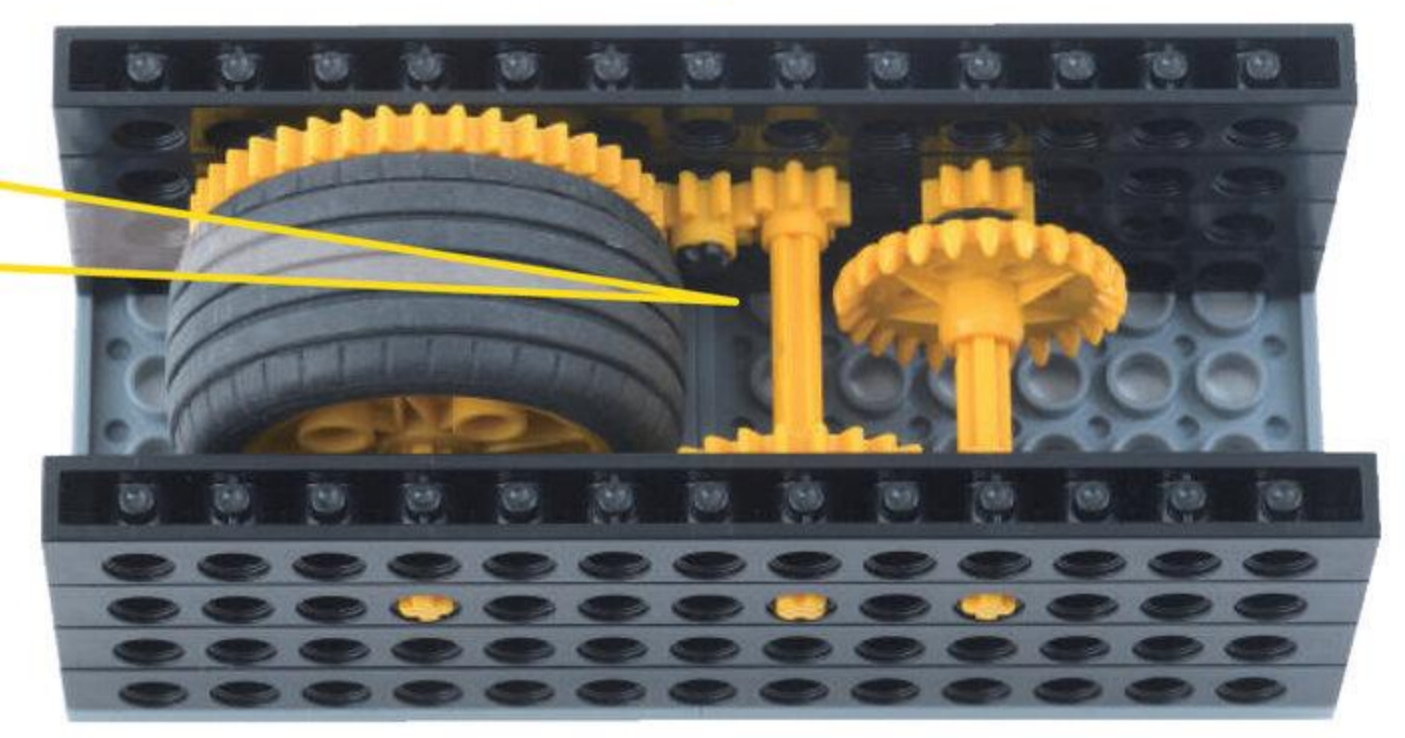
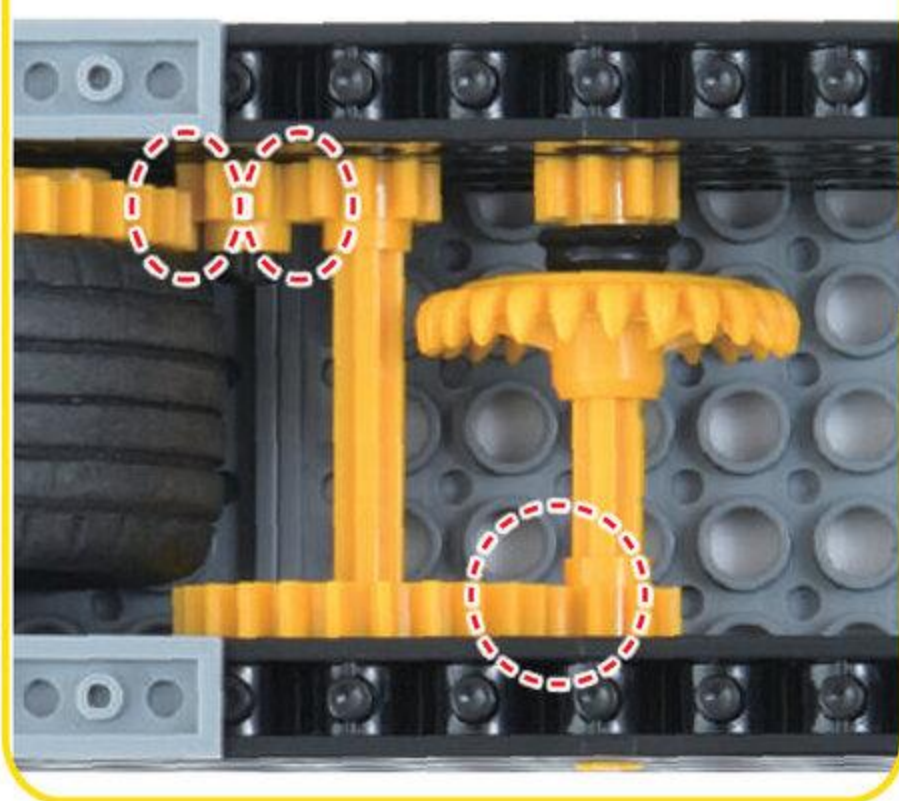

びいむよんぼち
ビーム 4 ポチ 2こ



しゃふとぺぐ
シャフトペグ 2こ



まいたぎあ
マイタギア 2こ

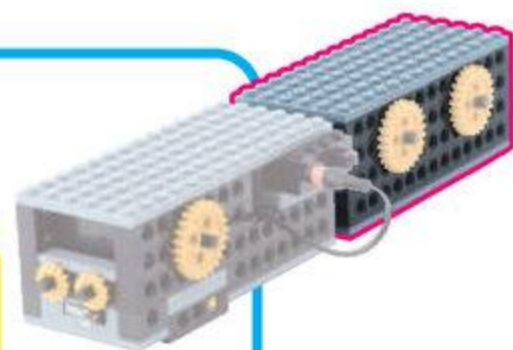

ほそぶれえとろくぼち
細プレート 6 ポチ 1こ



たいる
タイル 1こ

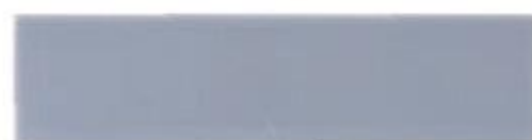

11

うらがえして
おこそう

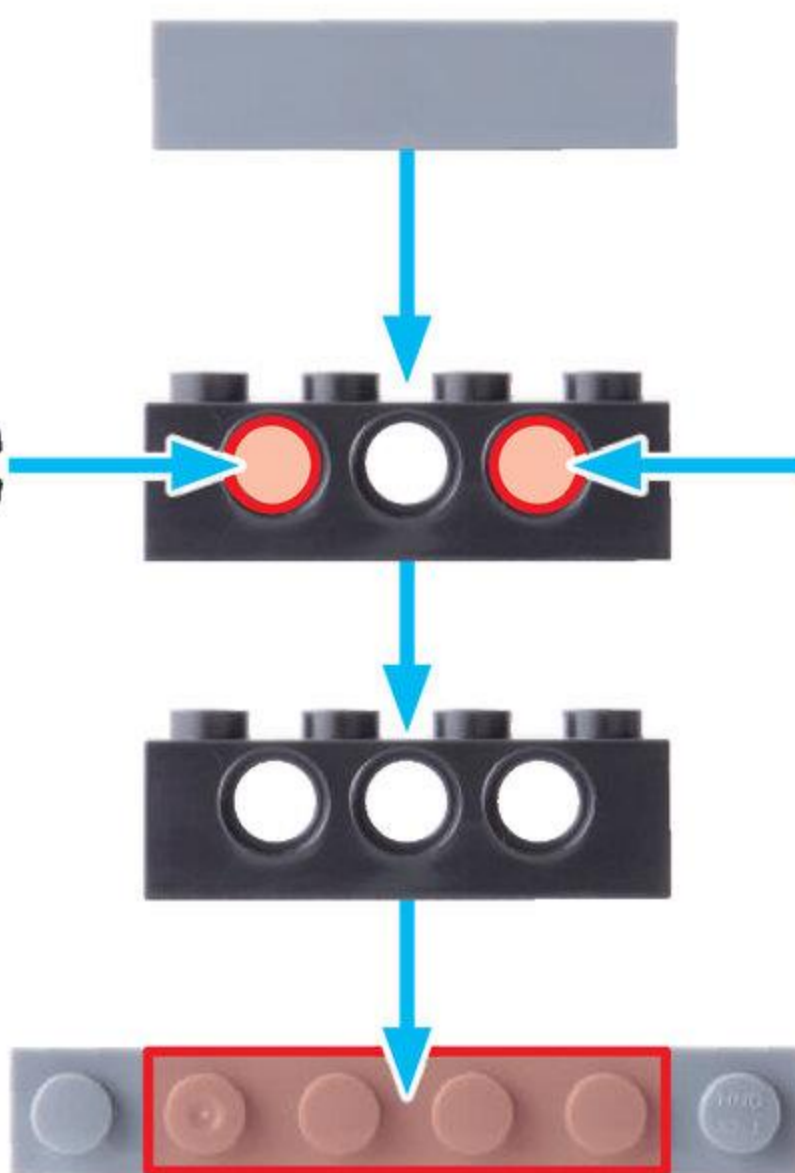

うらがえして
おこそう

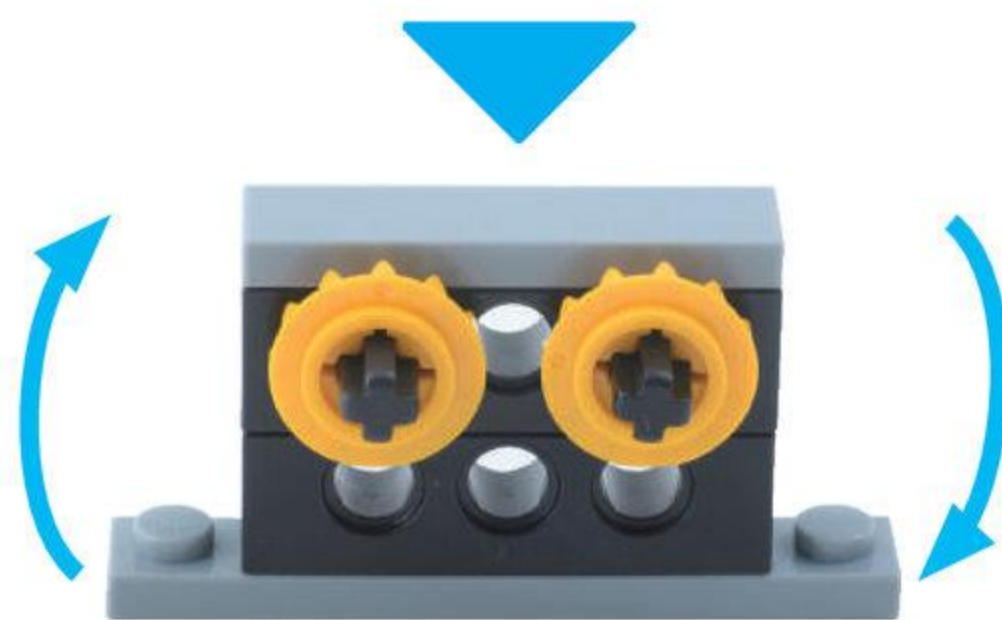

くみたてた^{ばあっ}パーツを
じょうげ ぎやくに
するよ

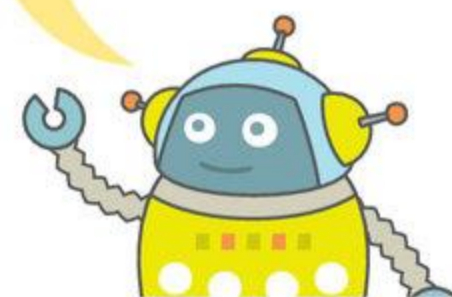

ほそぶれえとろくぼち
細プレート6ポチ **2**こ



うら

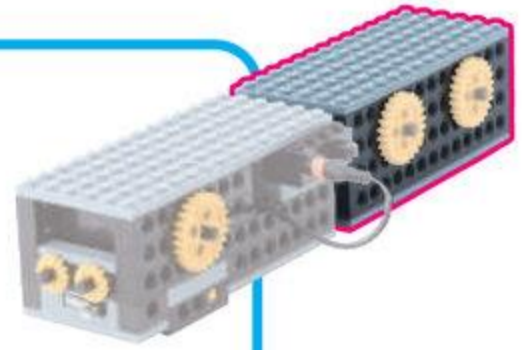

12

うらがえしておこう

うらがえしておこう

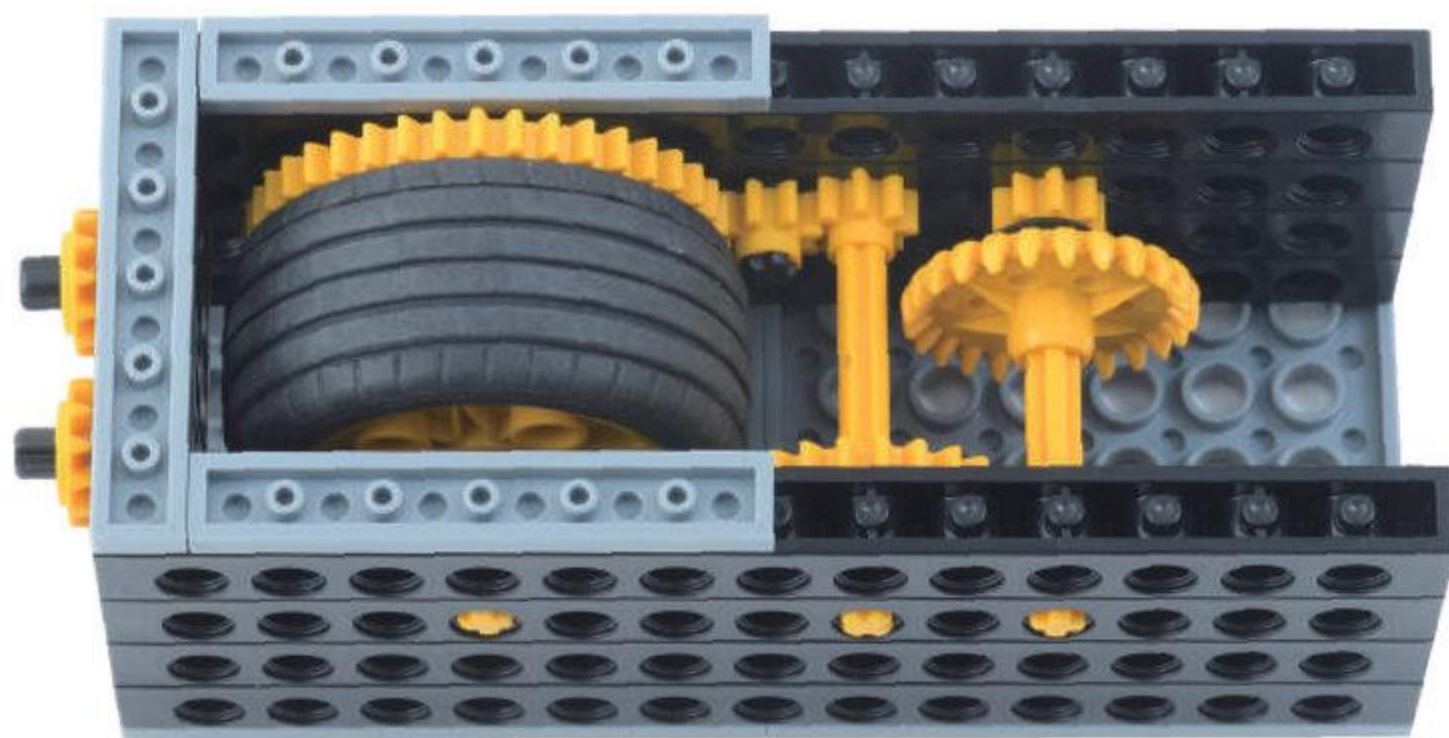
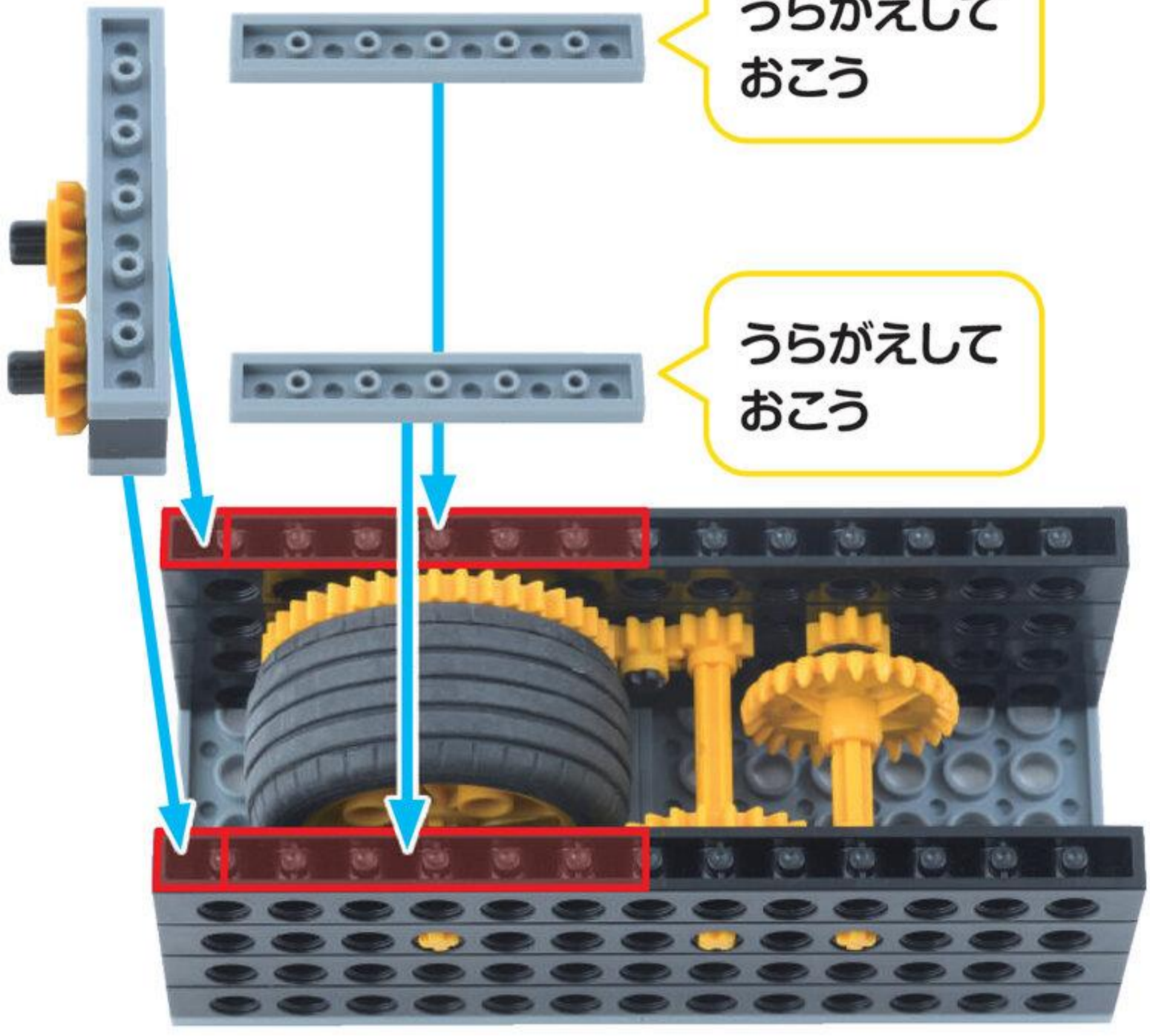

うしろのしゃりょうが
かんせい!

やったね!

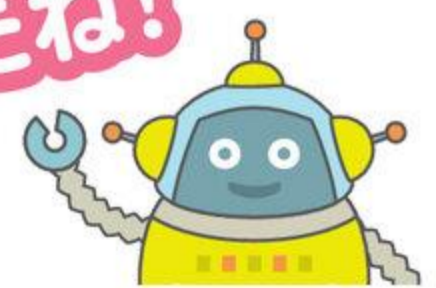

3 れんけつ

めやす 15 ぶん

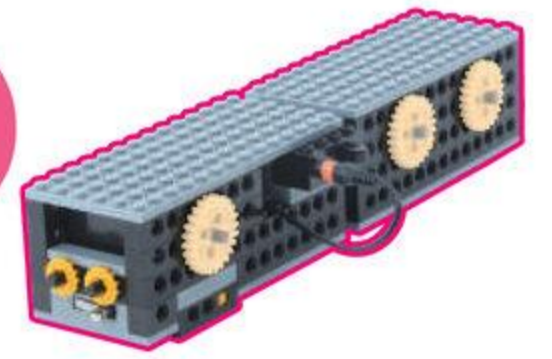

1

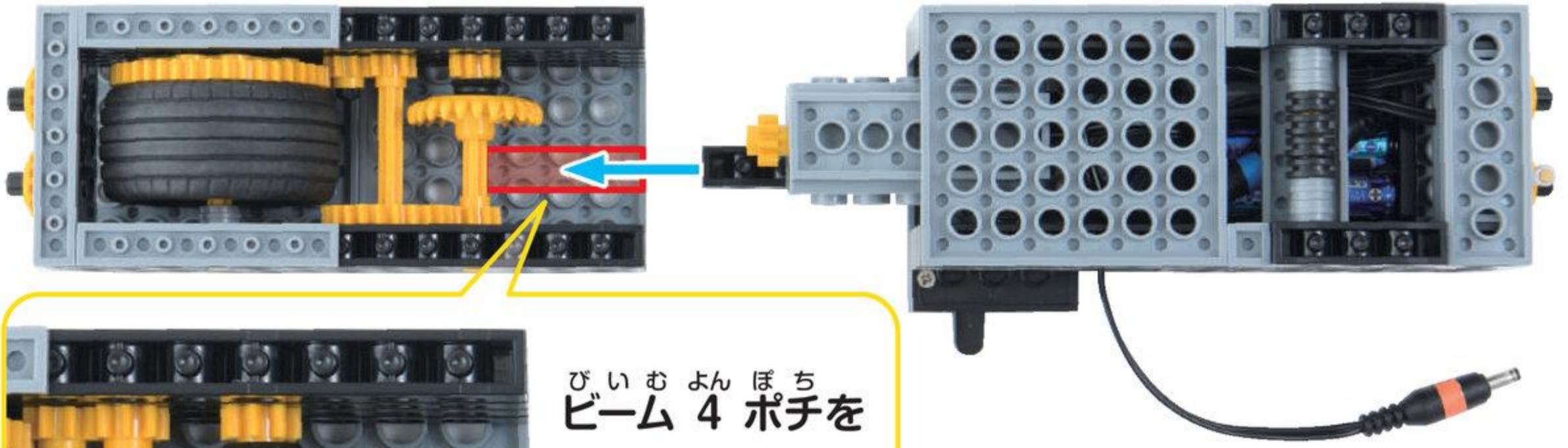

びいむよんぼち
ビーム 4 ポチを
はめる いちを
かくにんしよう

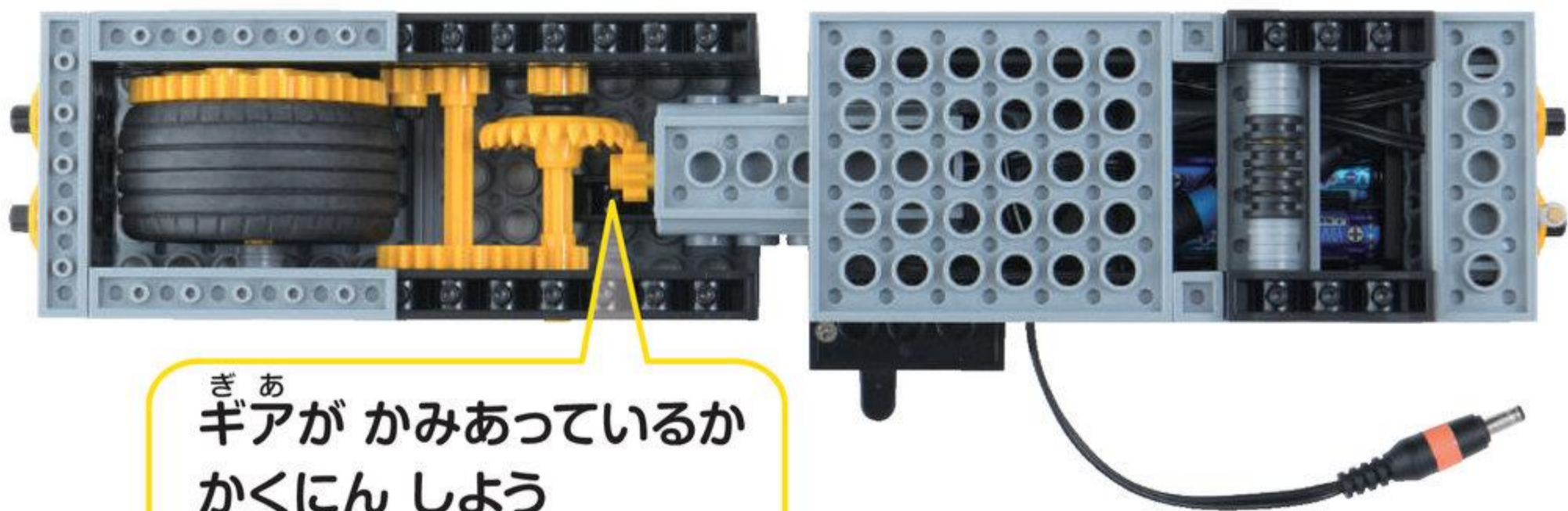

ぎあ
ギアがかみあっているか
かくにんしよう

ぶれえとえろ
プレートL 1こ

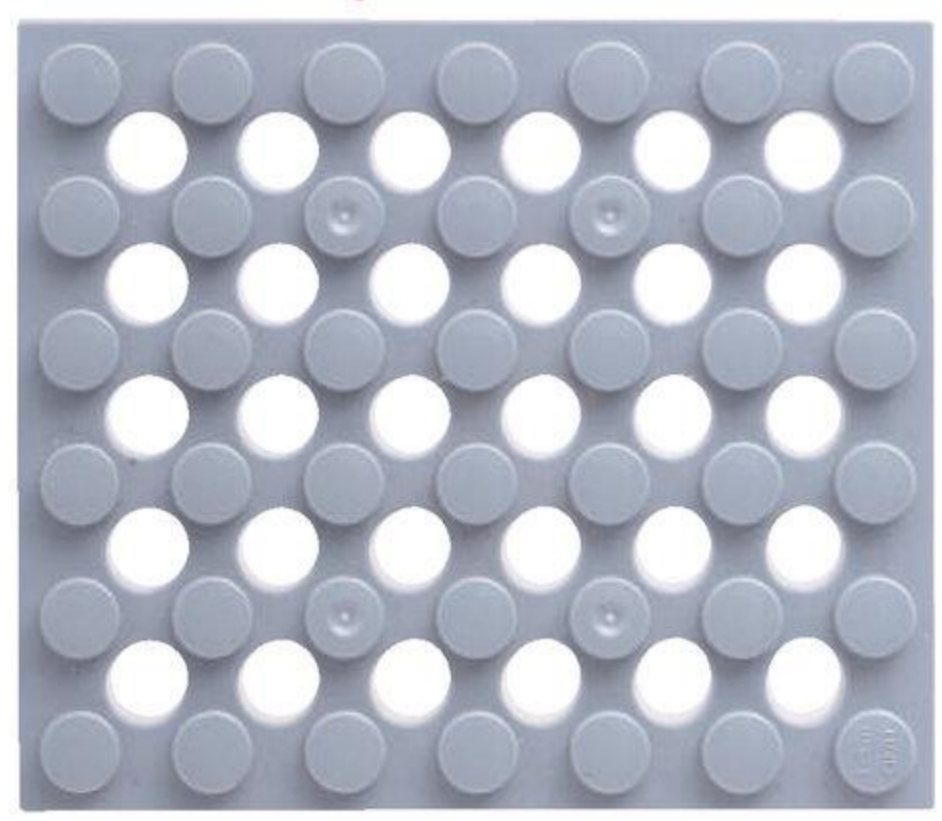

うら

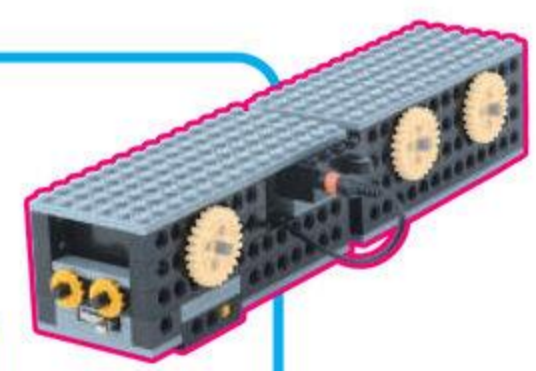
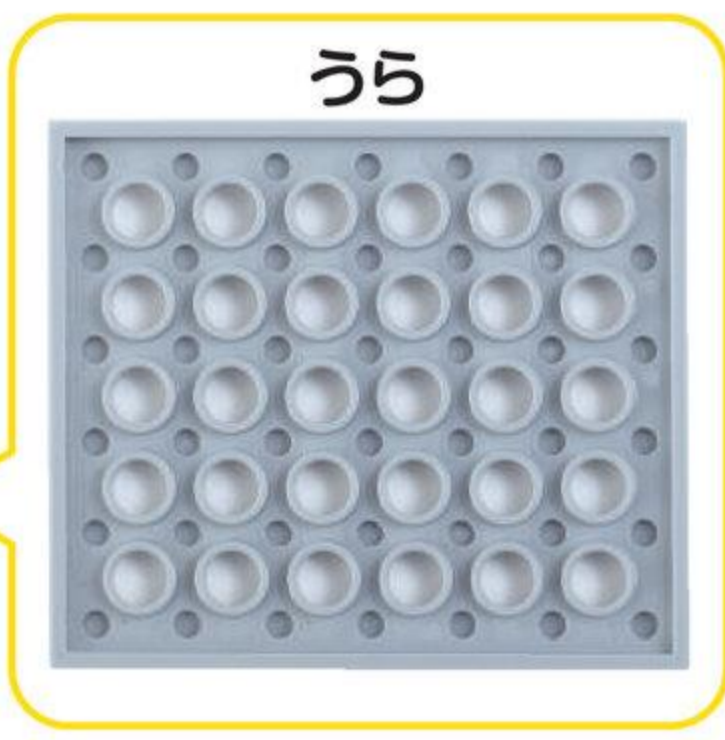

2

うらがえして
おころう

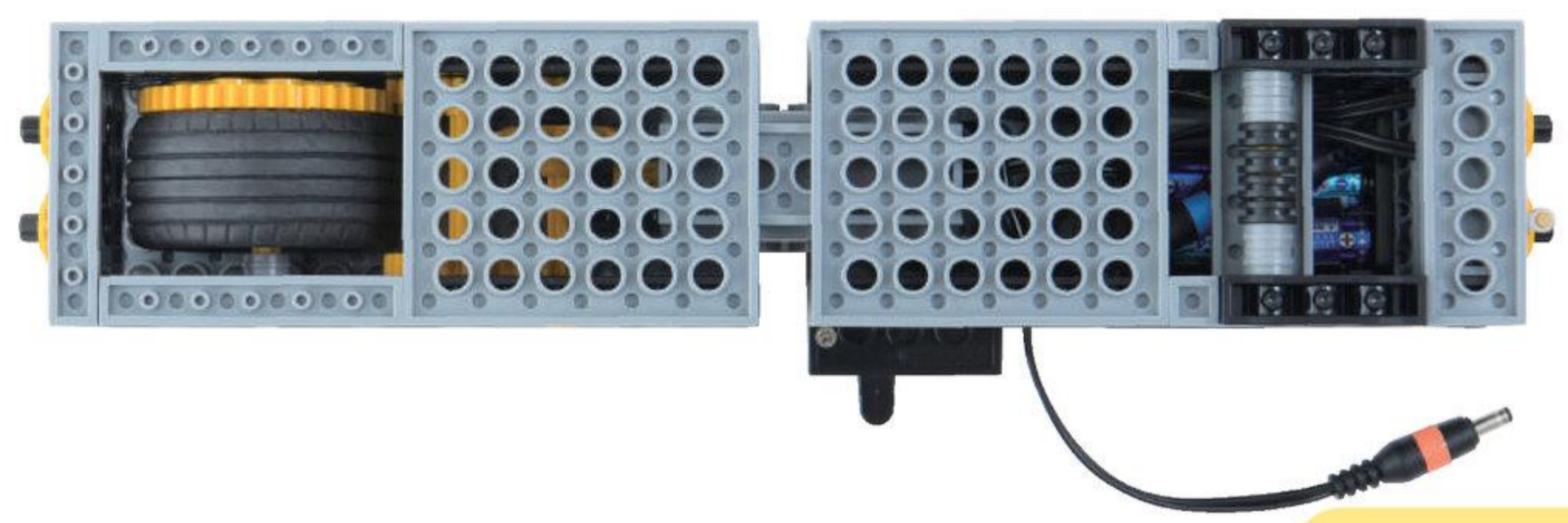
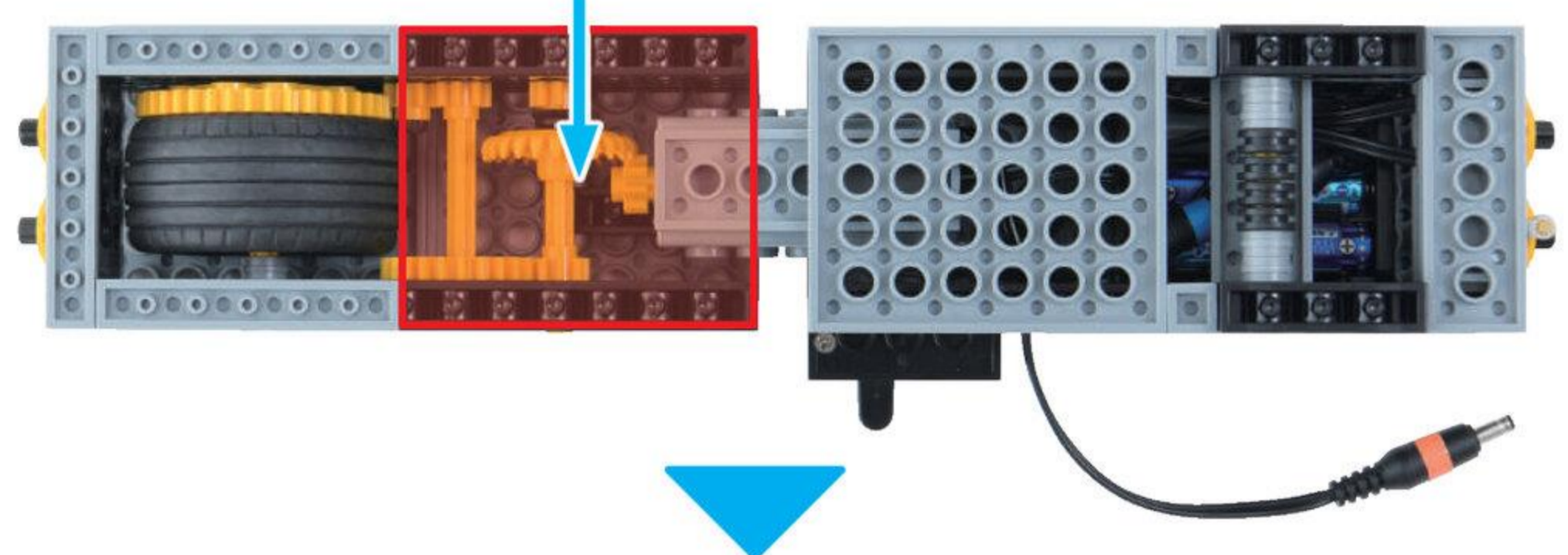
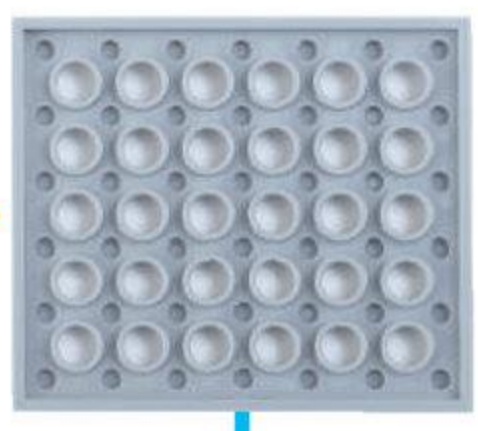

れんけつが
かんせい!

やったね!

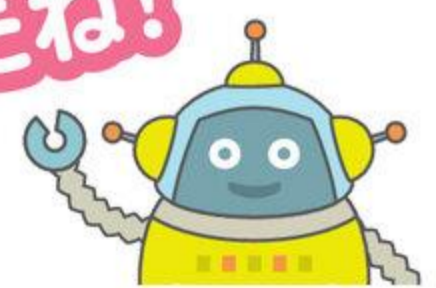

4 まど

めやす 5 ぶん



ぎあえむ
ギア M うす 7こ

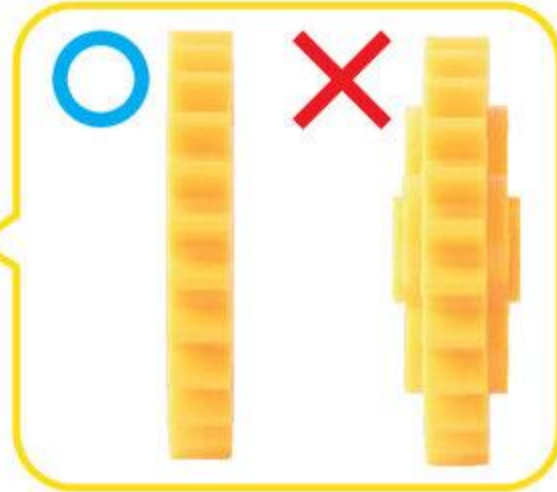
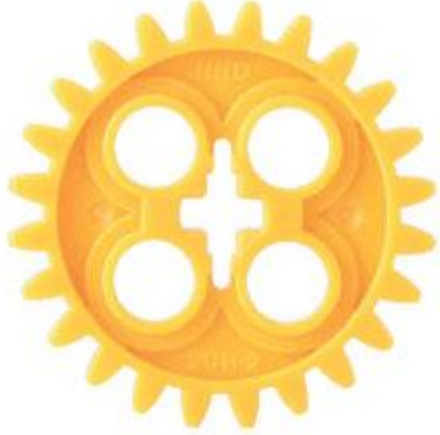

しゃふとぺぐ
シャフトペグ 7こ



1

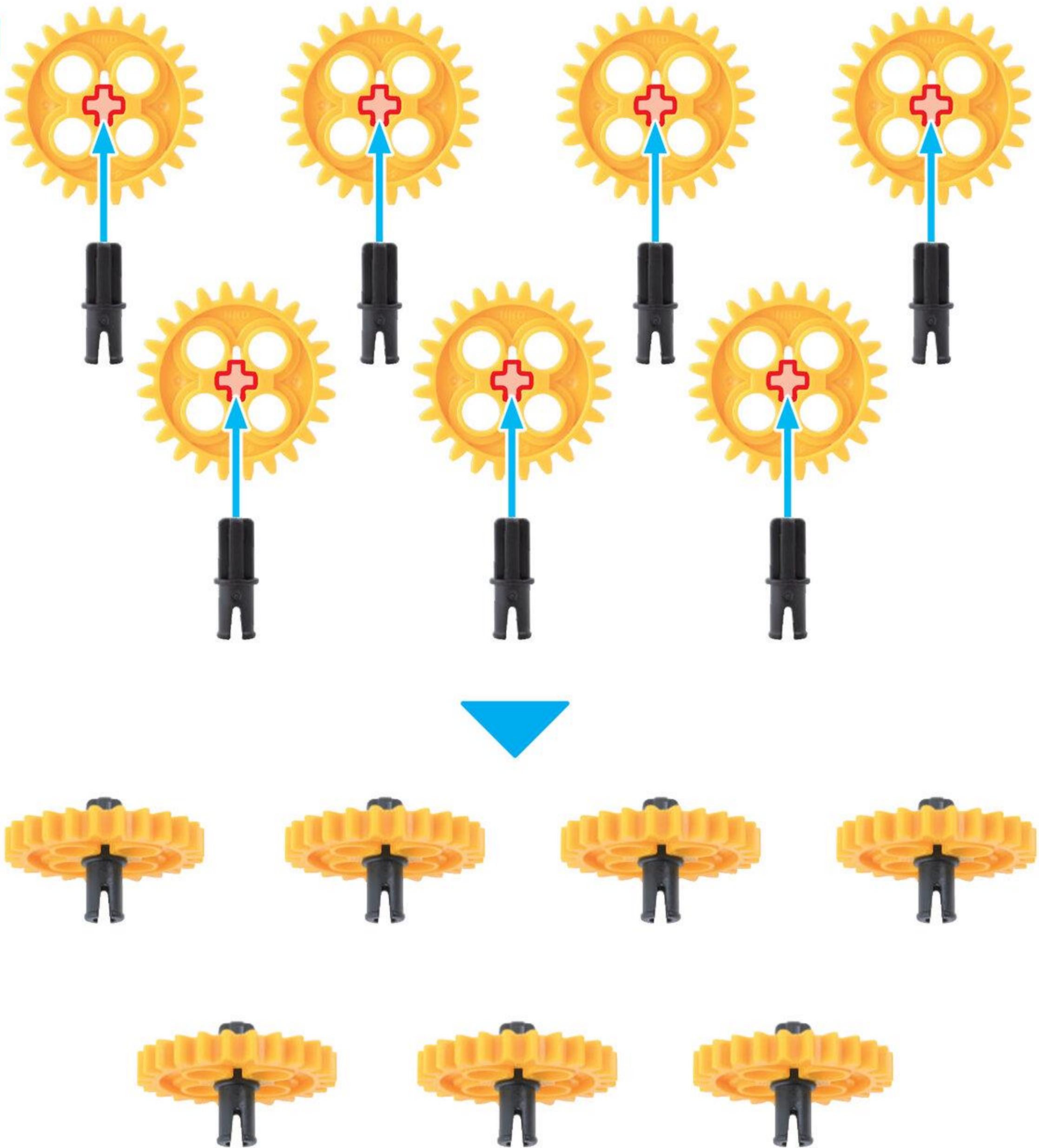

2

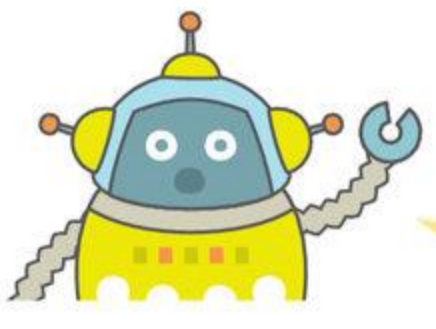

るぼっと
ロボットは おもてに しておこう

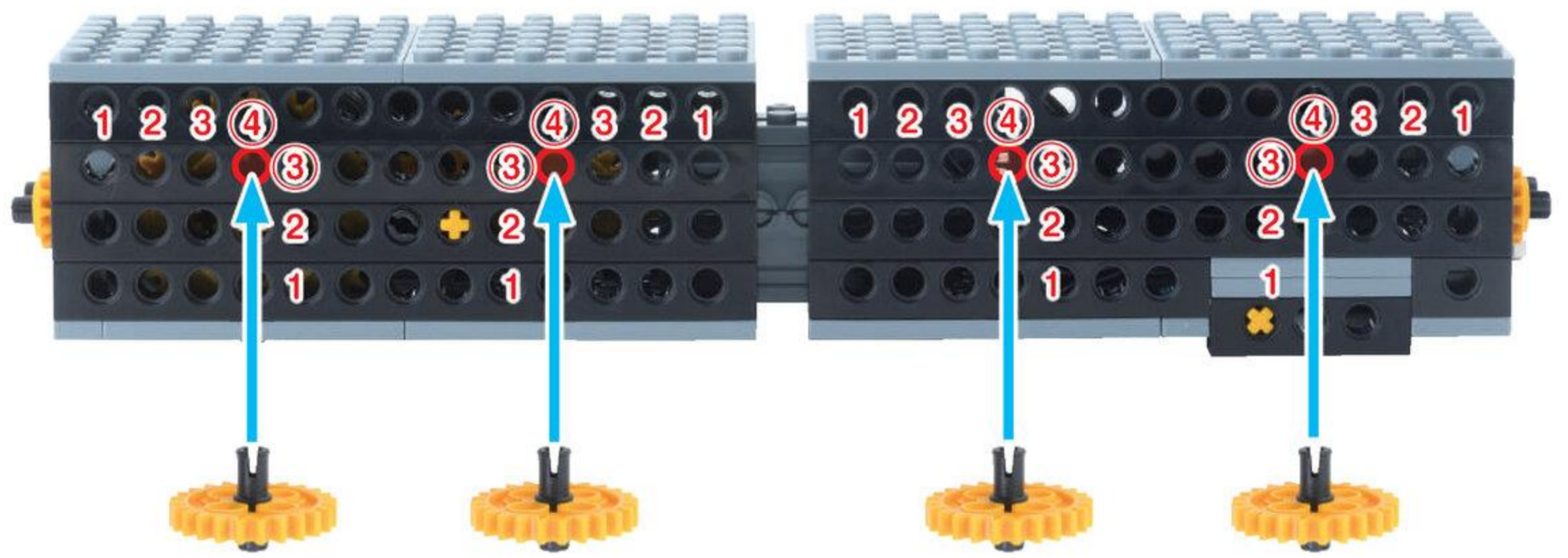
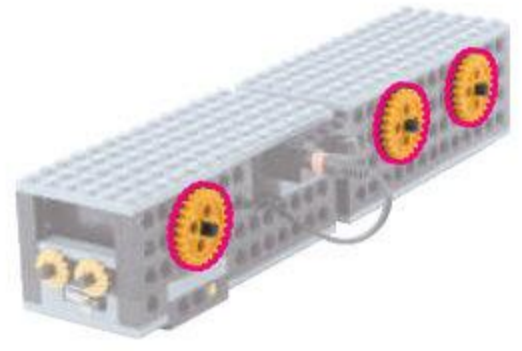

3

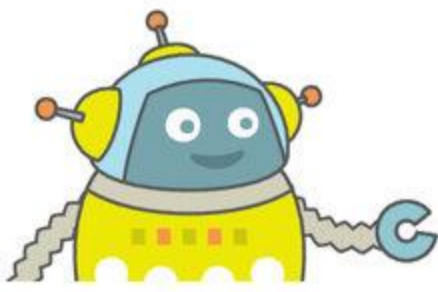

はんたいがわの まども とりつけるよ

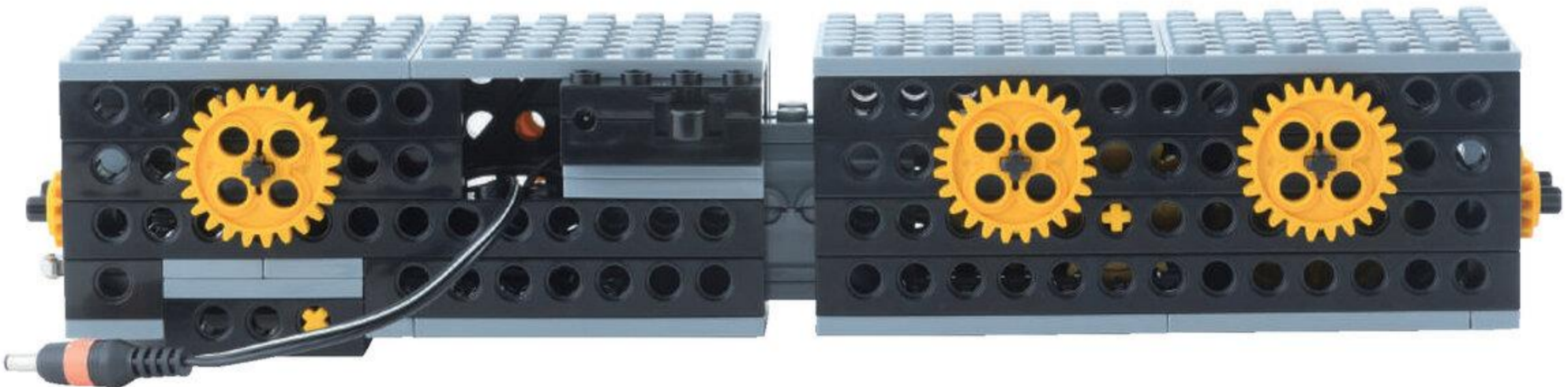
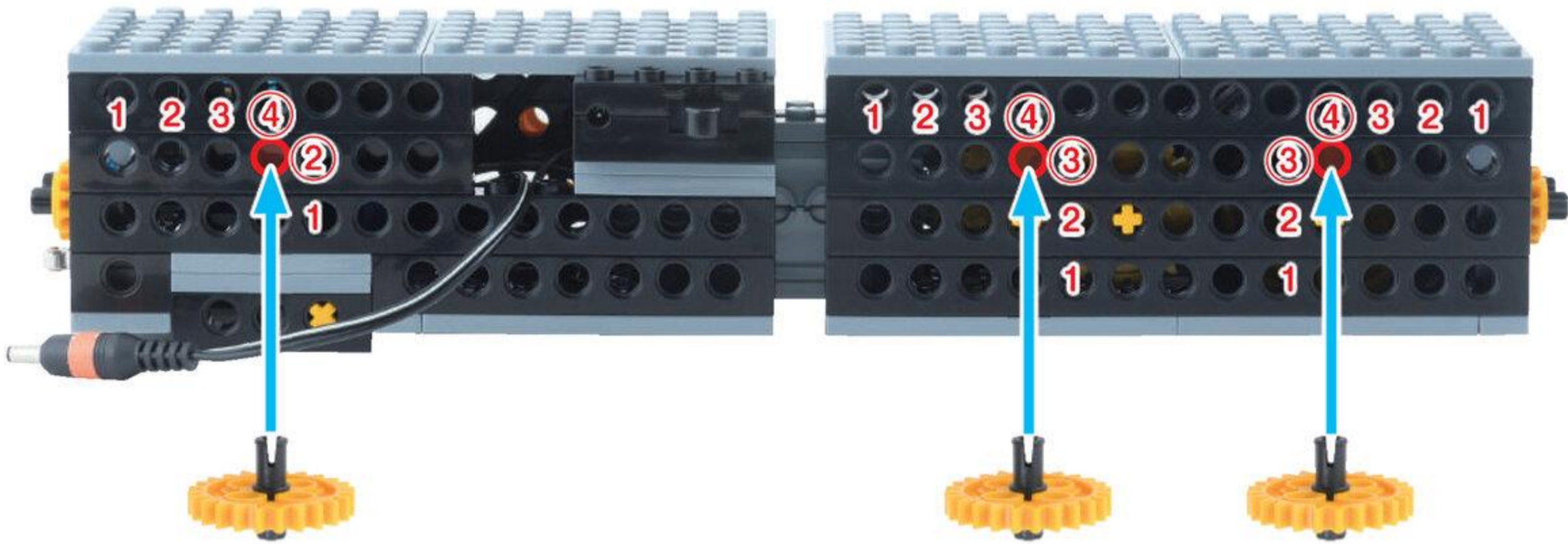
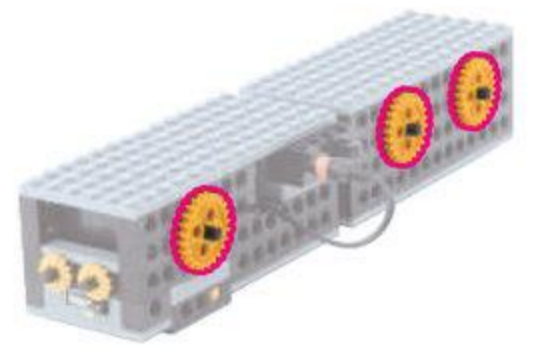

これで
かんせい!

よくできました!

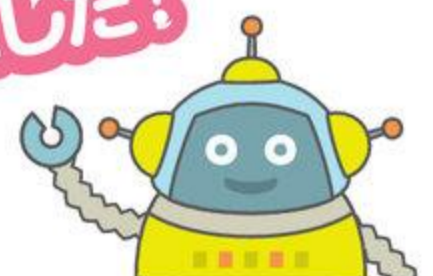

ロボットをうごかさう

めやす 5 ぶん

コードをつなごう

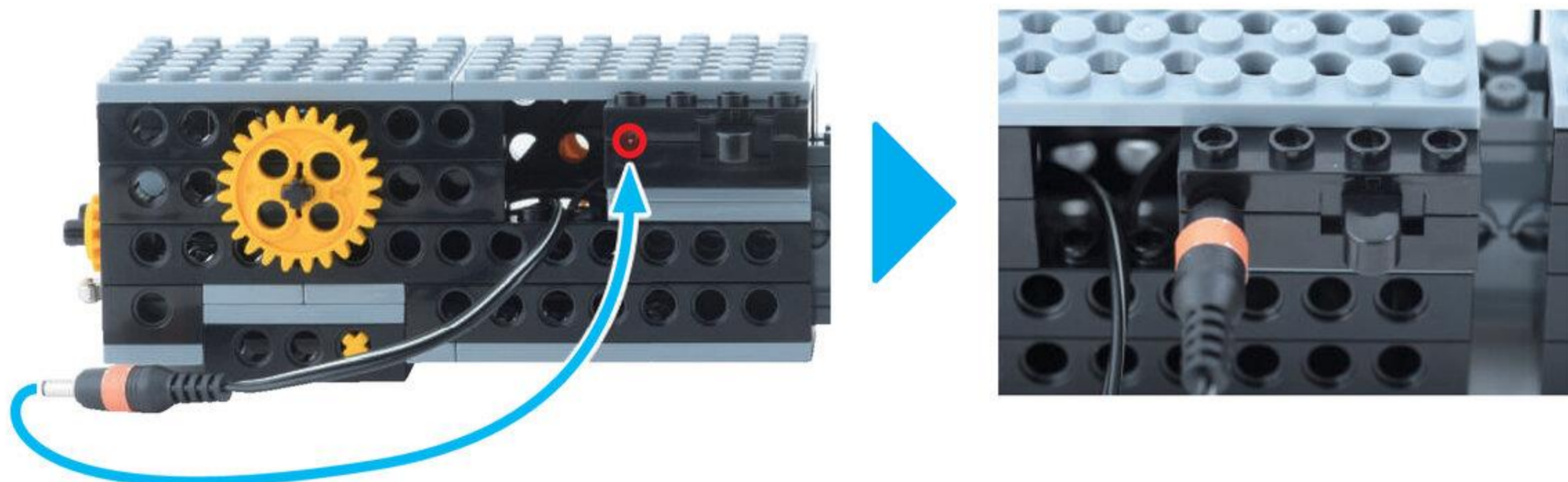

スイッチをいれてうごかさう

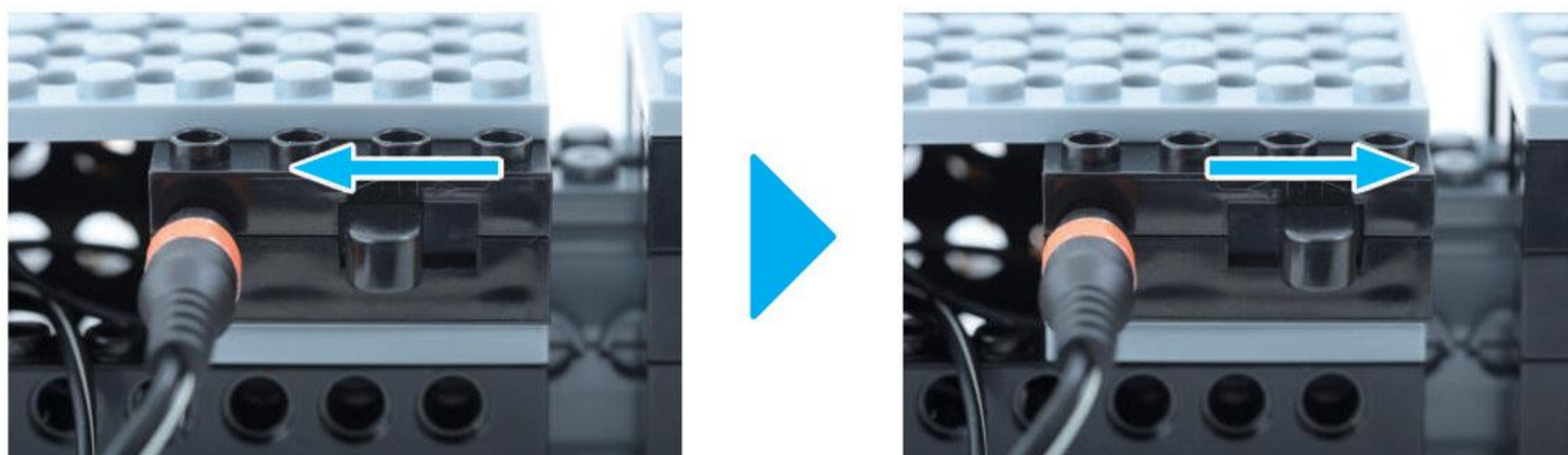

うまくすすむかな？
スイッチをいれる
ほうこうをかえると
すすむむきが変わるよ

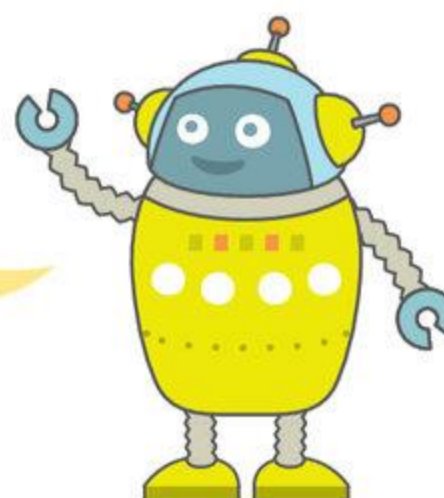

Q1 ^{ばあつ} パーツの なまえと しゃしんを せんで つなごう 

^{ふとぶれえと はちほち}
太プレート 8 ポチ ●



^{ほそぶれえと ろくほち}
細プレート 6 ポチ ●



^{ふとぶれえと ろくほち}
太プレート 6 ポチ ●



^{ほそぶれえと にほち}
細プレート 2 ポチ ●



^{ほそぶれえと よんほち}
細プレート 4 ポチ ●



^{ふとぶれえと よんほち}
太プレート 4 ポチ ●



^{ほそぶれえと いちほち}
細プレート 1 ポチ ●



Q2 ^{ぶれえと} プレートを なんまい かさねると ^{びいむ} ビームと おなじたかさに なるかな? ためしてみよう

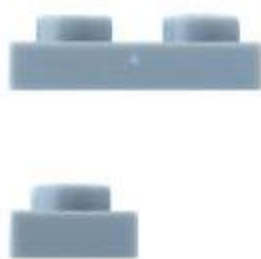

^{どれかに} (2 ・ 3 ・ 4) まい 



ヒューマンアカデミー ジュニア
STEAMスクール



ロボット教室

ロボットのきょうかしよ

プレプライマリーコース

2

しゅっぱつしんこう「ロボレール」



★だい2かい

2023 ねん

10 がつ

にち

なまえ

もくじ

だい 2 かい

きょうの よてい	47	2ふん
くみたて		
1. えき	48~56	80ふん
2. レールガイド <small>れえるがいと</small>	57~59	
3. レール <small>れえる</small>	60~80	
ロボットを うごかそう <small>ろぼっと</small>	81	
じゆうに かいぞう してみよう	82	
まちがい さがし	83	3ふん
かたづけ		5ふん

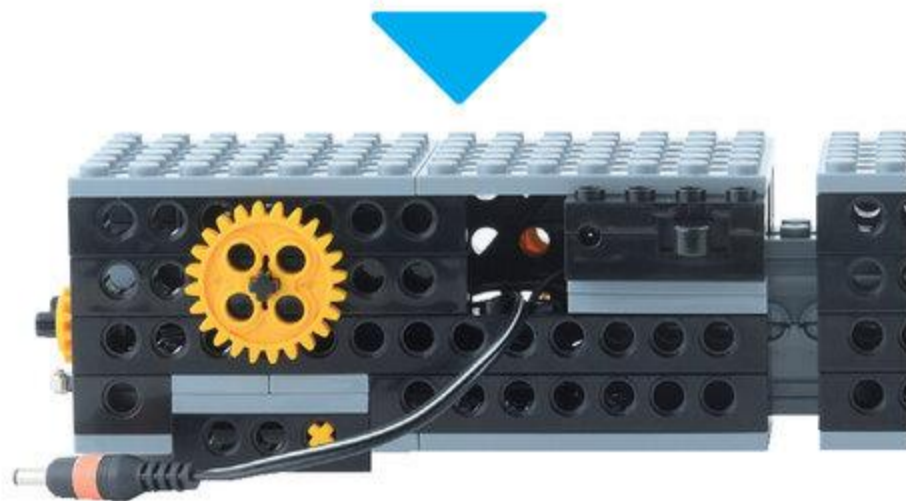
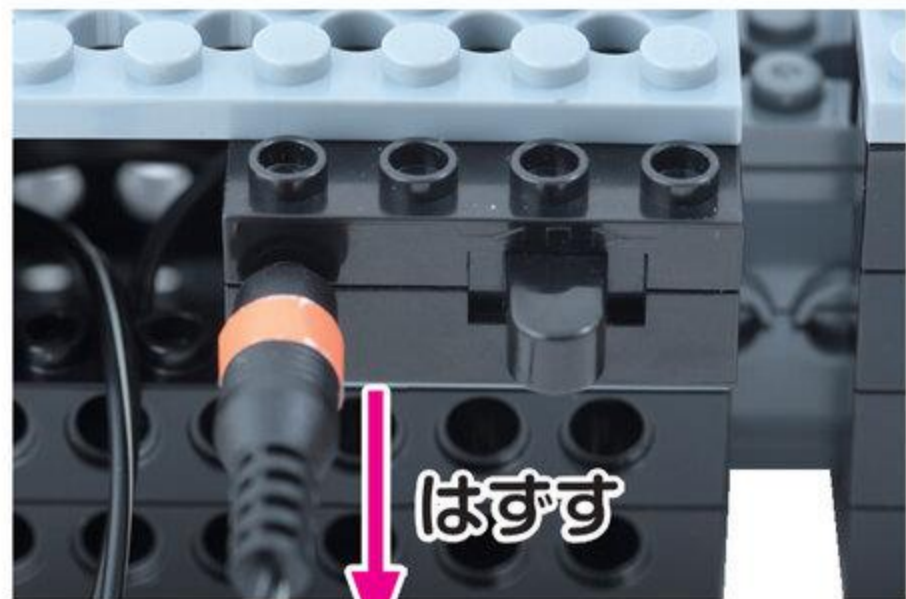

だい1かいで
つないだ こおどコードは
はずそう

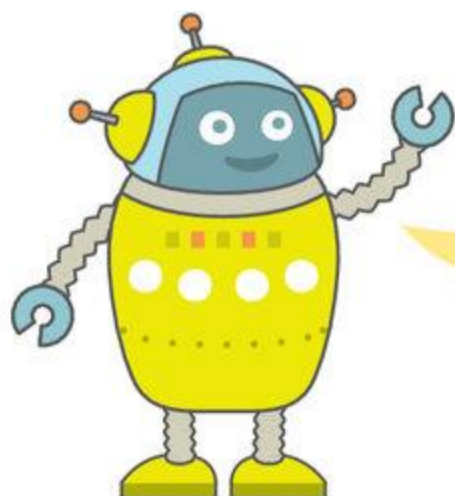
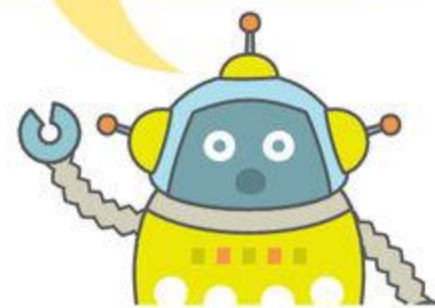

こんかいは
えきや れえるレールをつくるよ

きょうの よてい めやす 2 ふん

このじゅんばんでつくるよ!

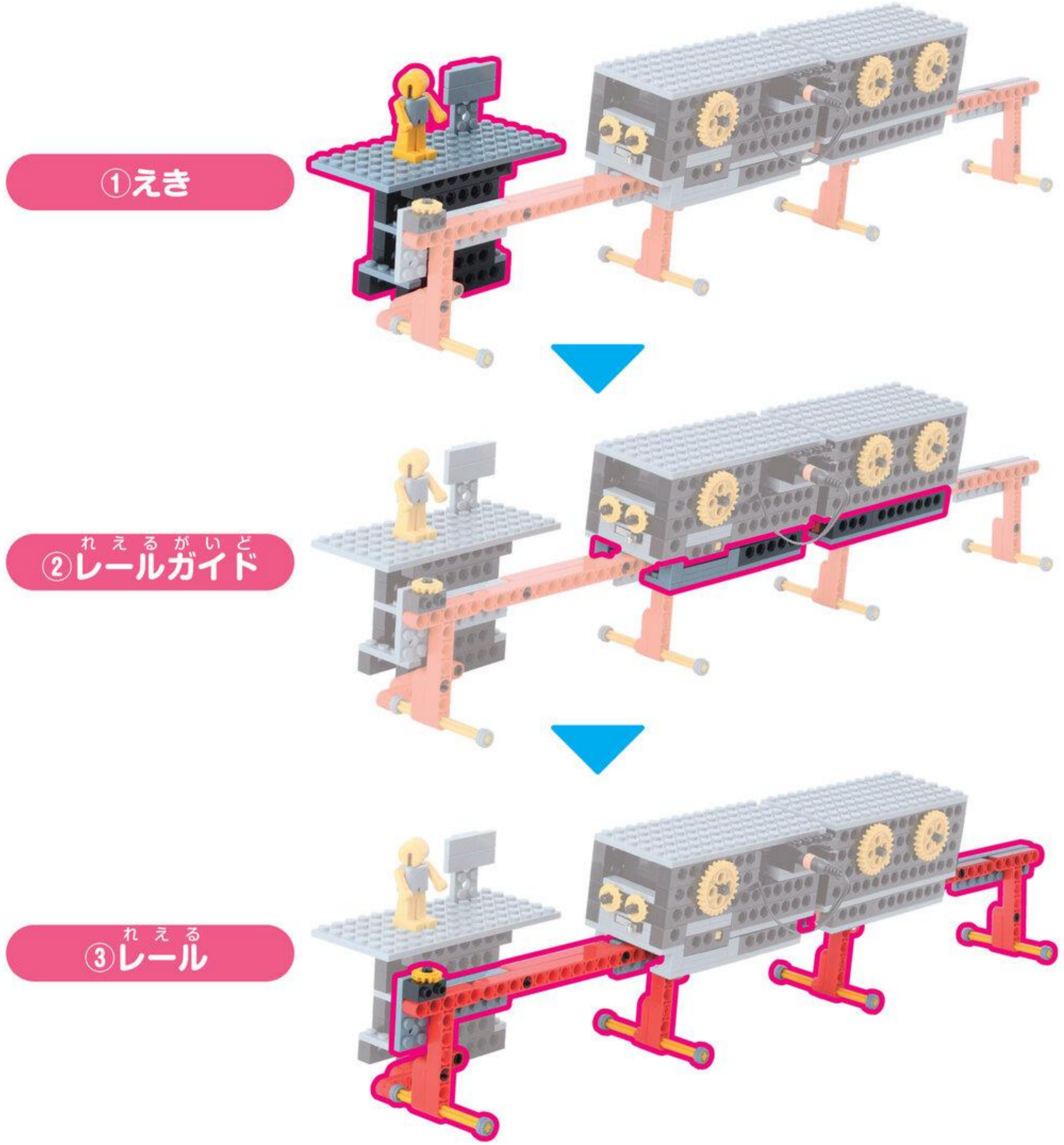
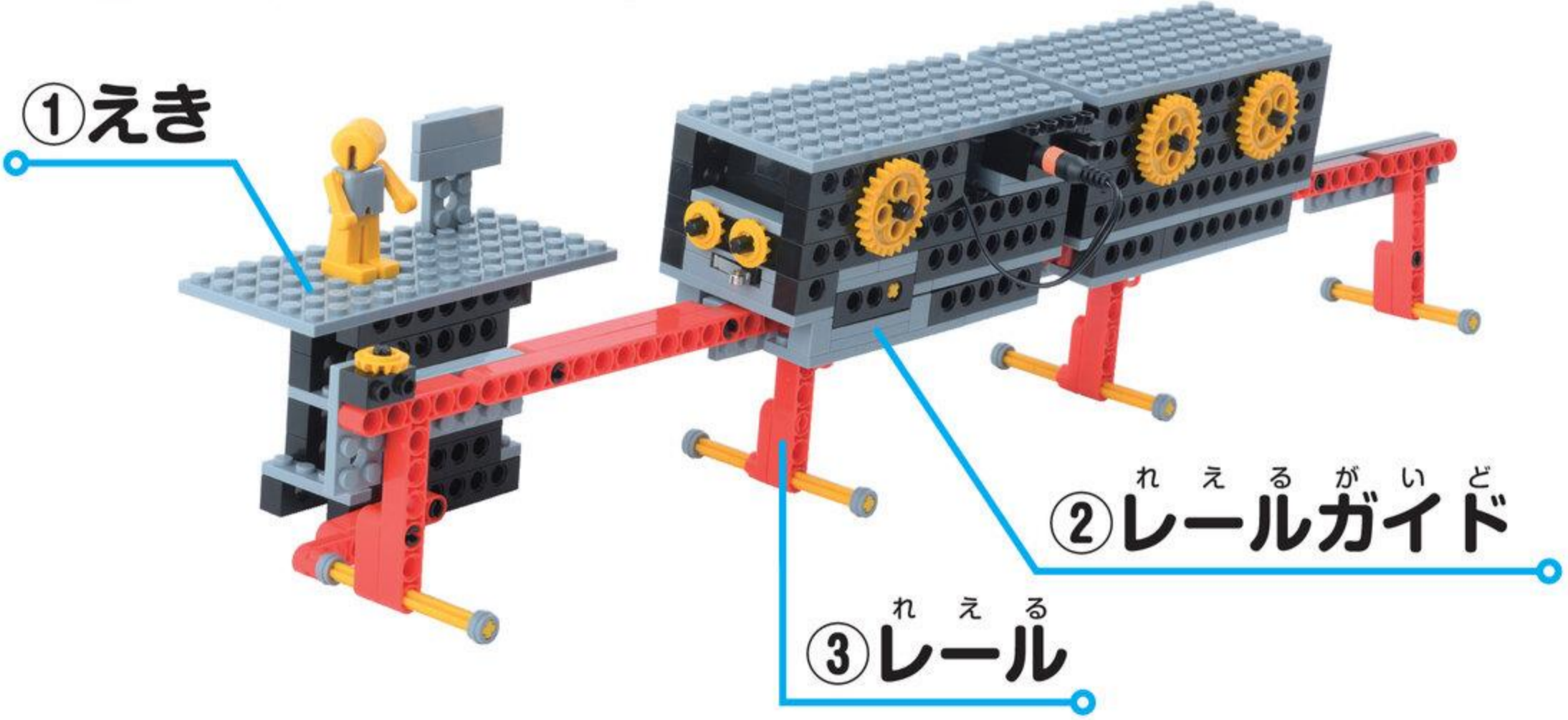



1 えき めやす 15 ぶん

ぶれえとろ プレート L 2こ

うら

びいむはちほち ビーム 8 ポチ 2こ

うら

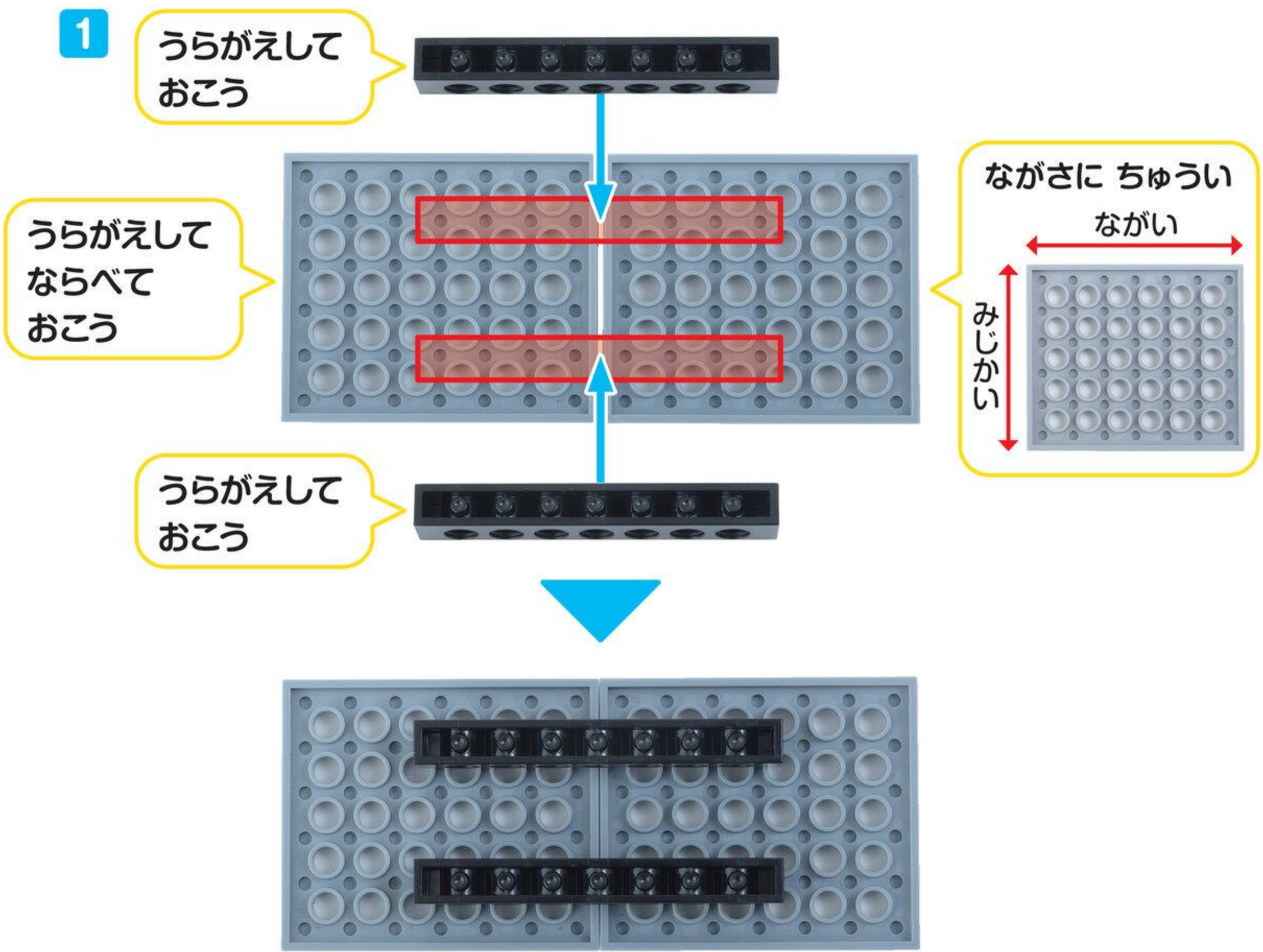

ぱいろっと
パイロット 1こ



ふとぶれえとよんぼち
太プレート4ポチ 1こ



たいる
タイル 2こ



2

おもてにして
おこう

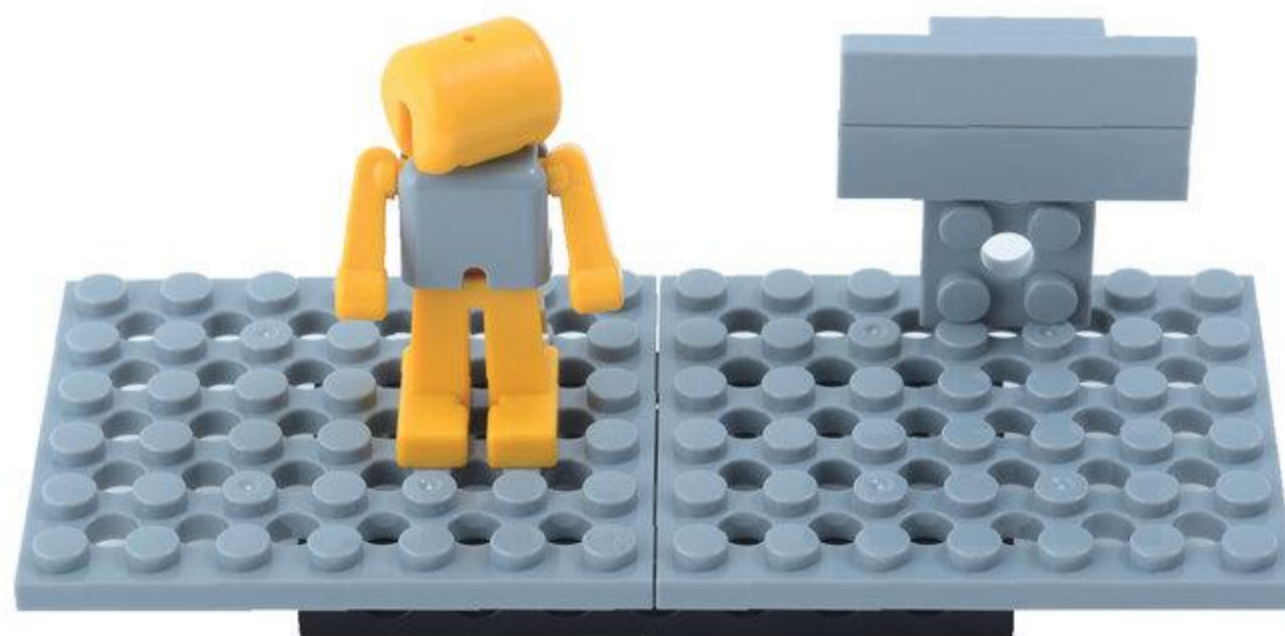
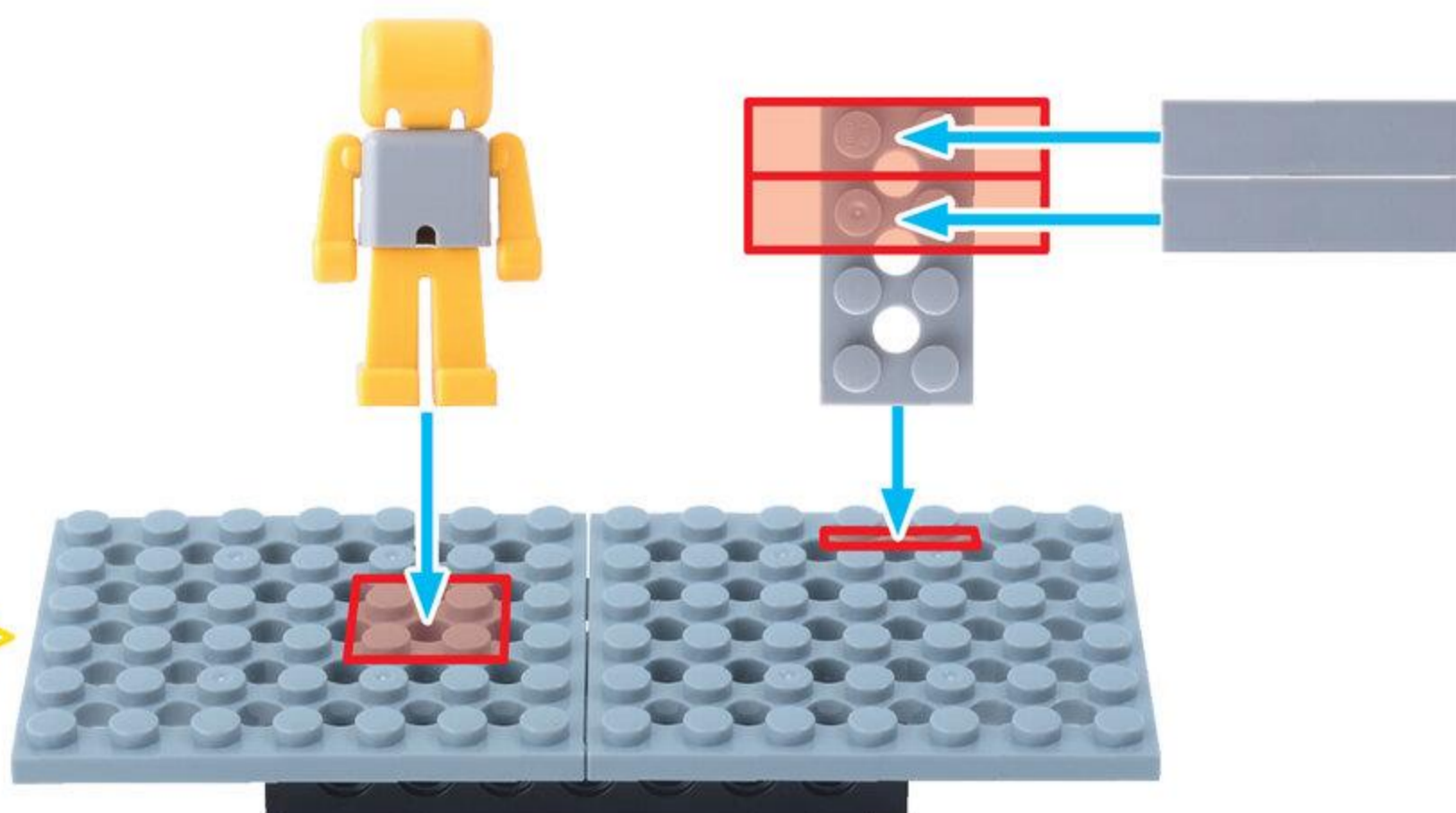

びいむはちほち
ビーム 8 ポチ 2こ



ほそぶれえとよんほち
細プレート 4 ポチ 2こ



3

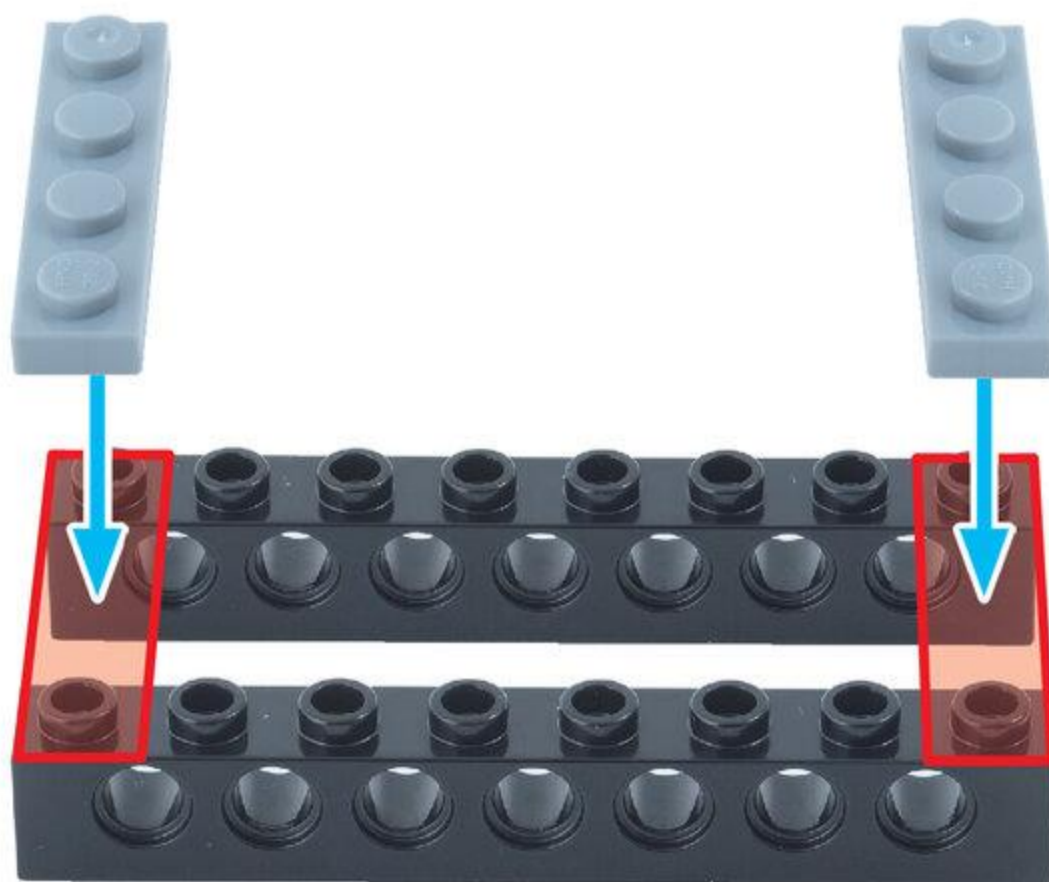

びいむろほち
ビーム6ポチ 4こ

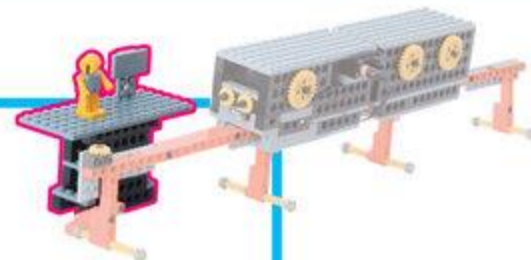

4



5

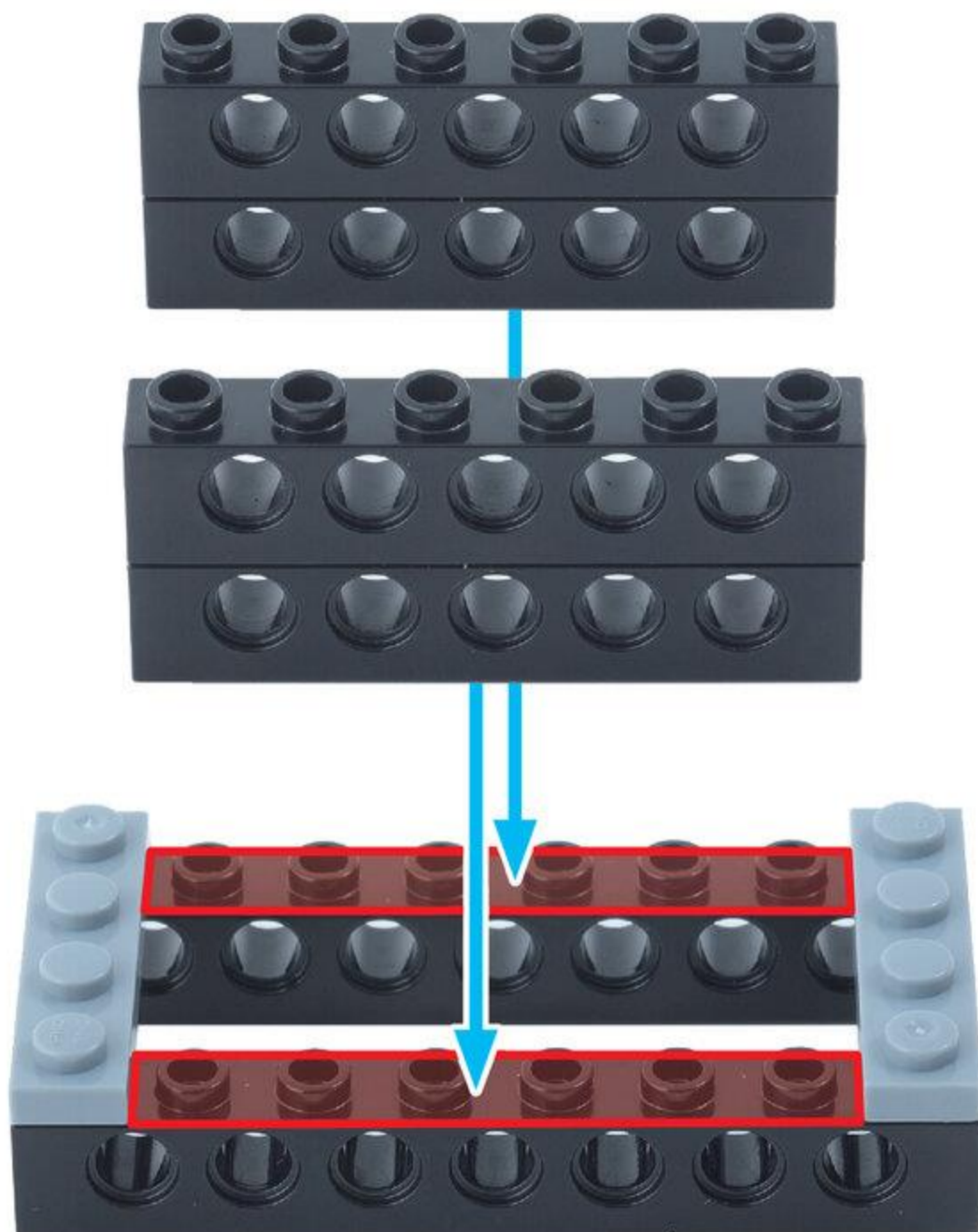

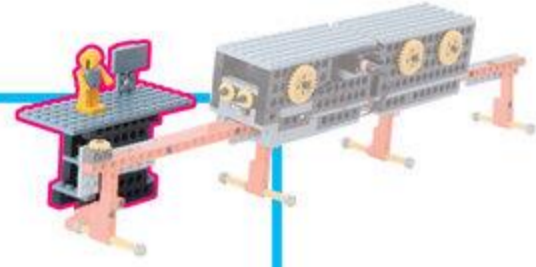

ふとぶれえとよんぼち
太プレート4ポチ 3こ



6

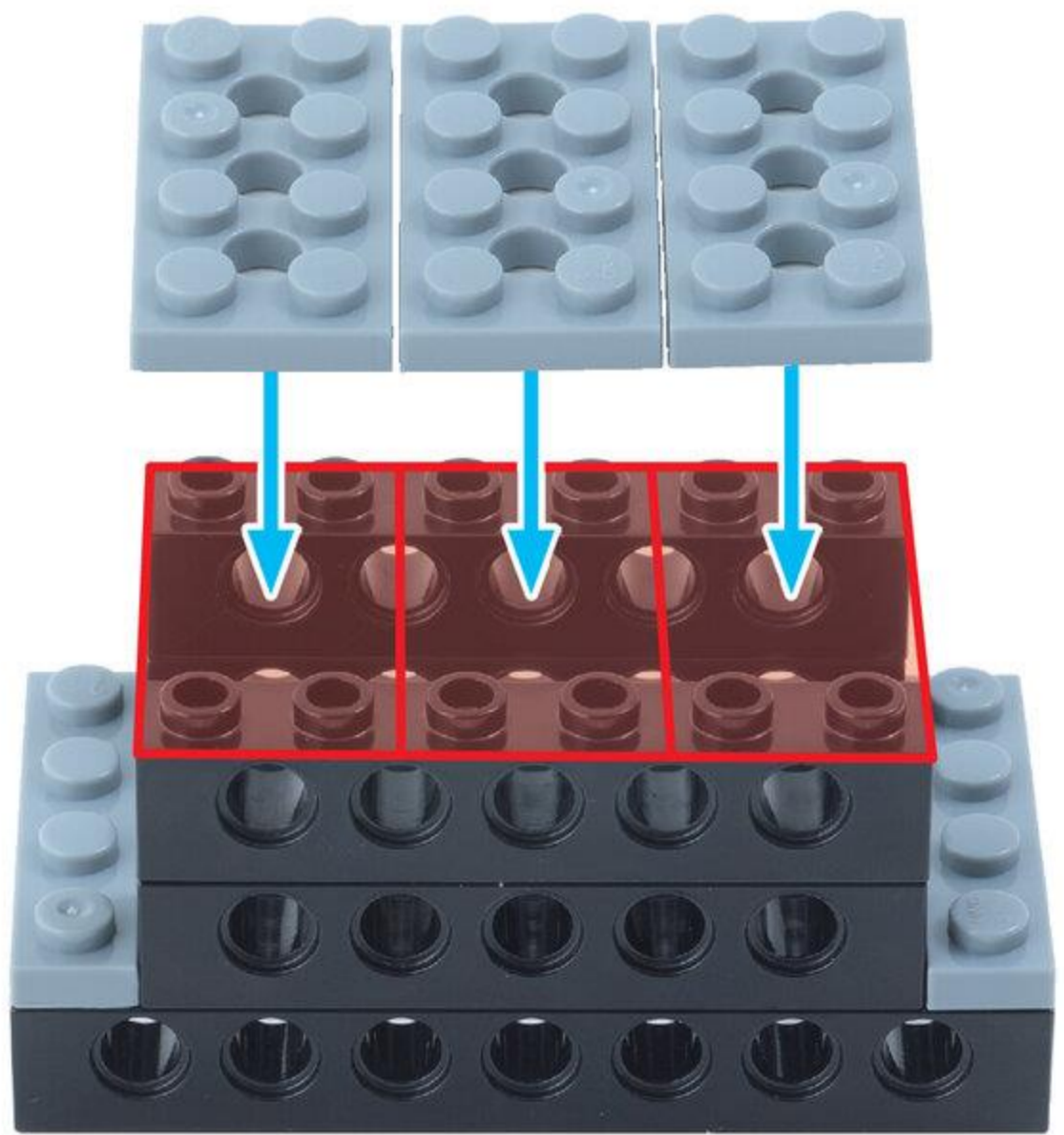



びいむろくほち
ビーム6ポチ 4こ



7



8

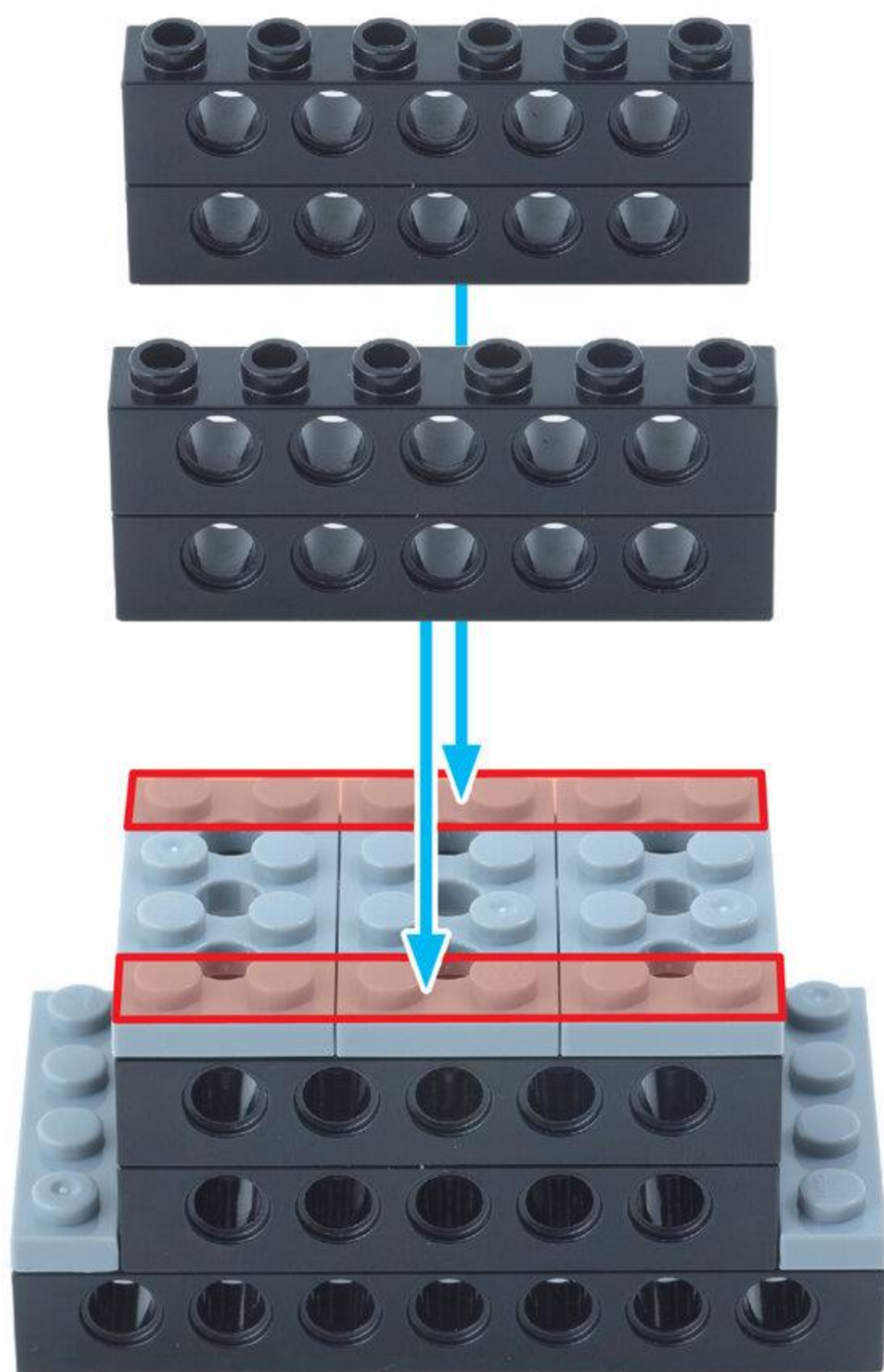

9

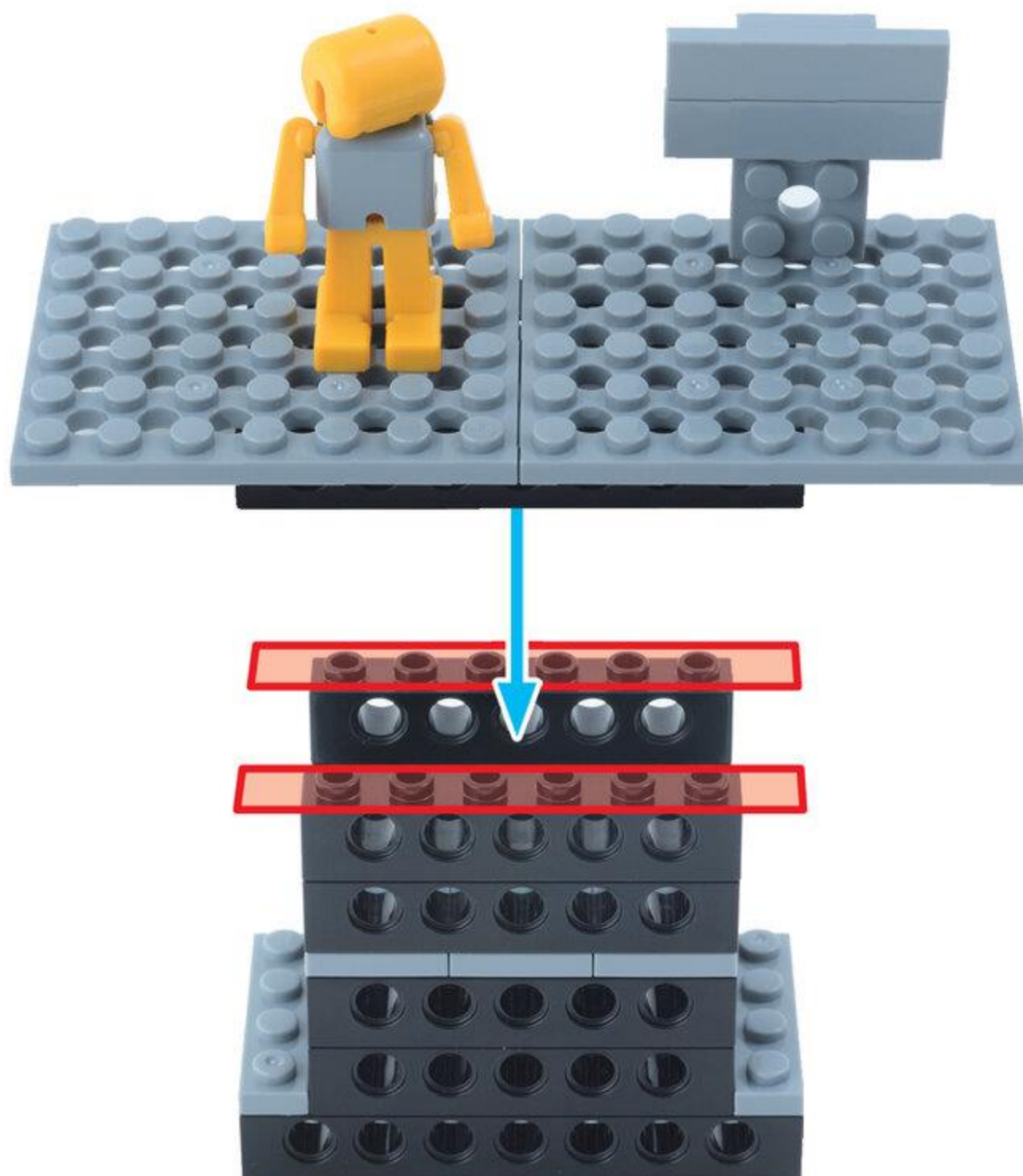

えきが
かんせい!

やったね!

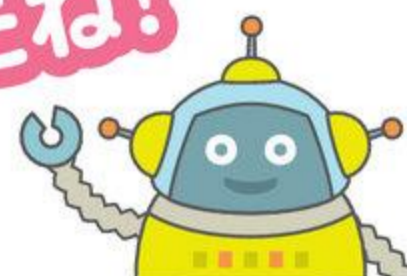



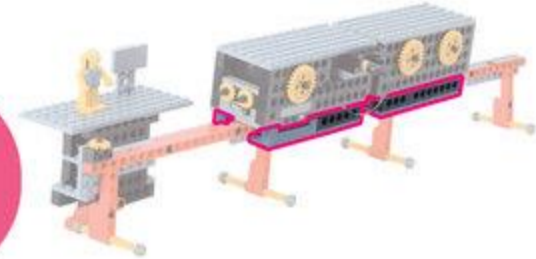

2

れえるがいど
レールガイド

めやす 10 ぶん



びいむはちほち ビーム 8 ポチ 2こ 	びいむよんほち ビーム 4 ポチ 2こ 
ふとぶれえとはちほち 太プレート 8 ポチ 2こ 	ふとぶれえとよんほち 太プレート 4 ポチ 2こ 
ろっどごあな ロッド 5 アナ 2こ 	

1

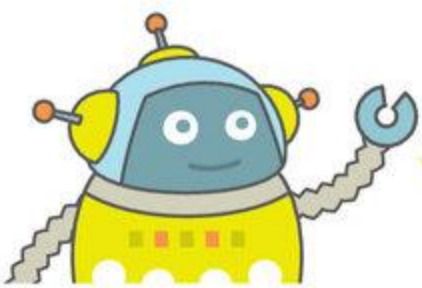

うしろよの ^{れえるがいど}レールガイドを
むかいあわせで 2こ つくるよ

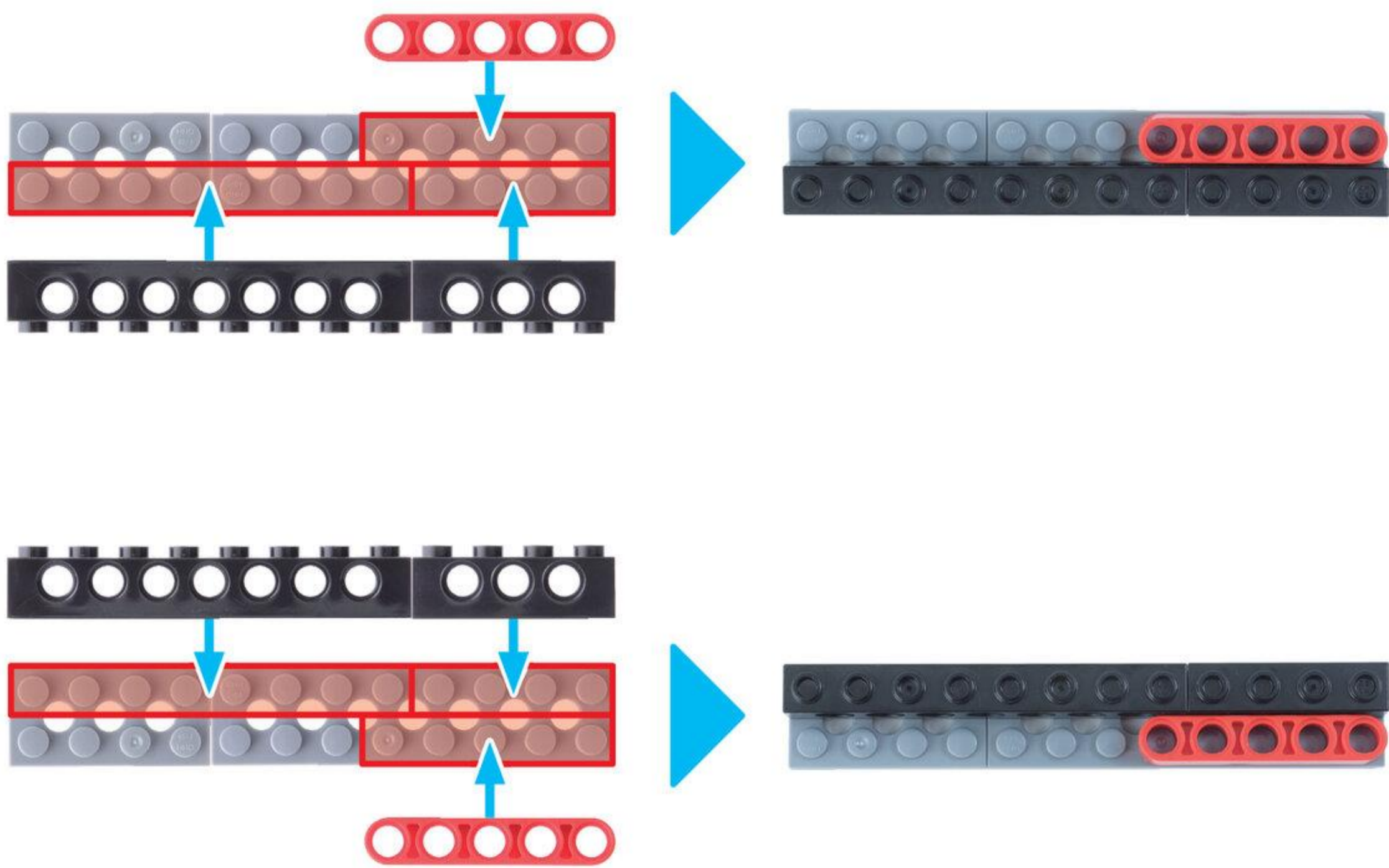

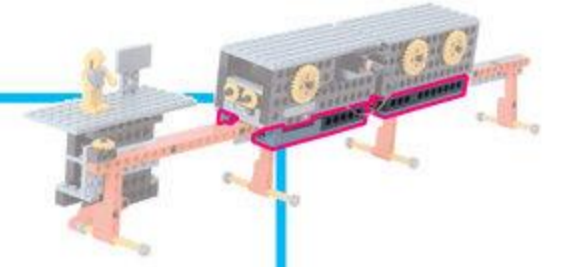

びいむろくぼち
ビーム 6 ポチ 2こ



ふとぶれえとはちぼち
太プレート 8 ポチ 2こ



ろっどごあな
ロッド 5 アナ 2こ



びいむいちぼち
ビーム 1 ポチ 4こ



ふとぶれえとよんぼち
太プレート 4 ポチ 2こ



ほそぶれえとよんぼち
細プレート 4 ポチ 4こ



2

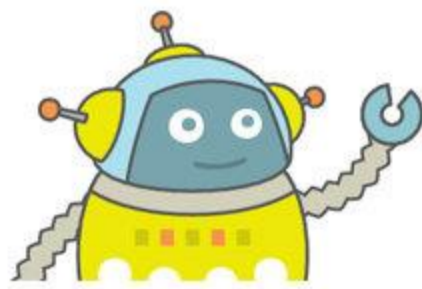

まえようの ^{れえるがいと} レールガイドを
むかいあわせで 2こ つくるよ

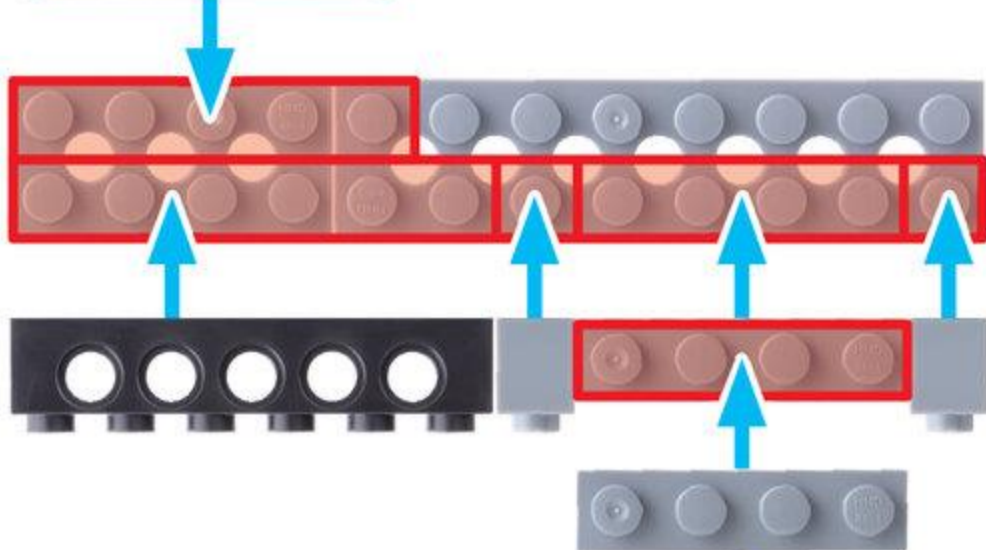

2まい
かさねる

2まい
かさねる

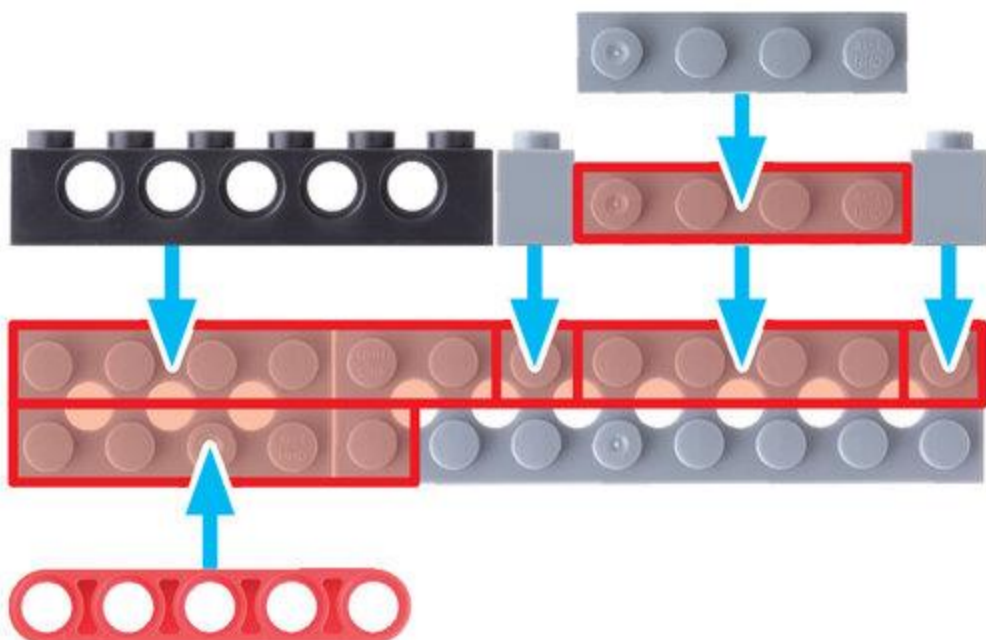

3

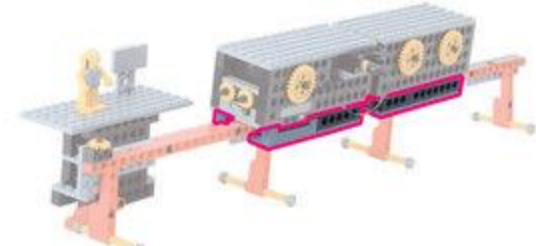

うらがえして
おこご

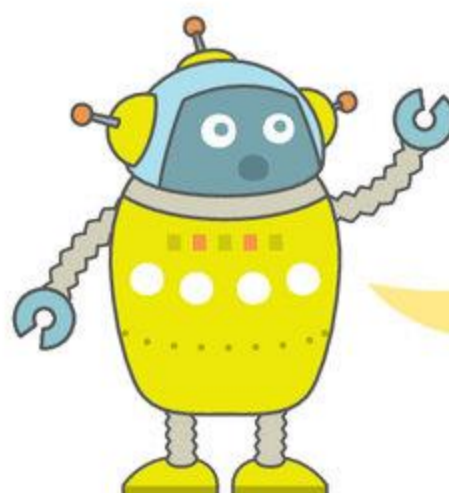
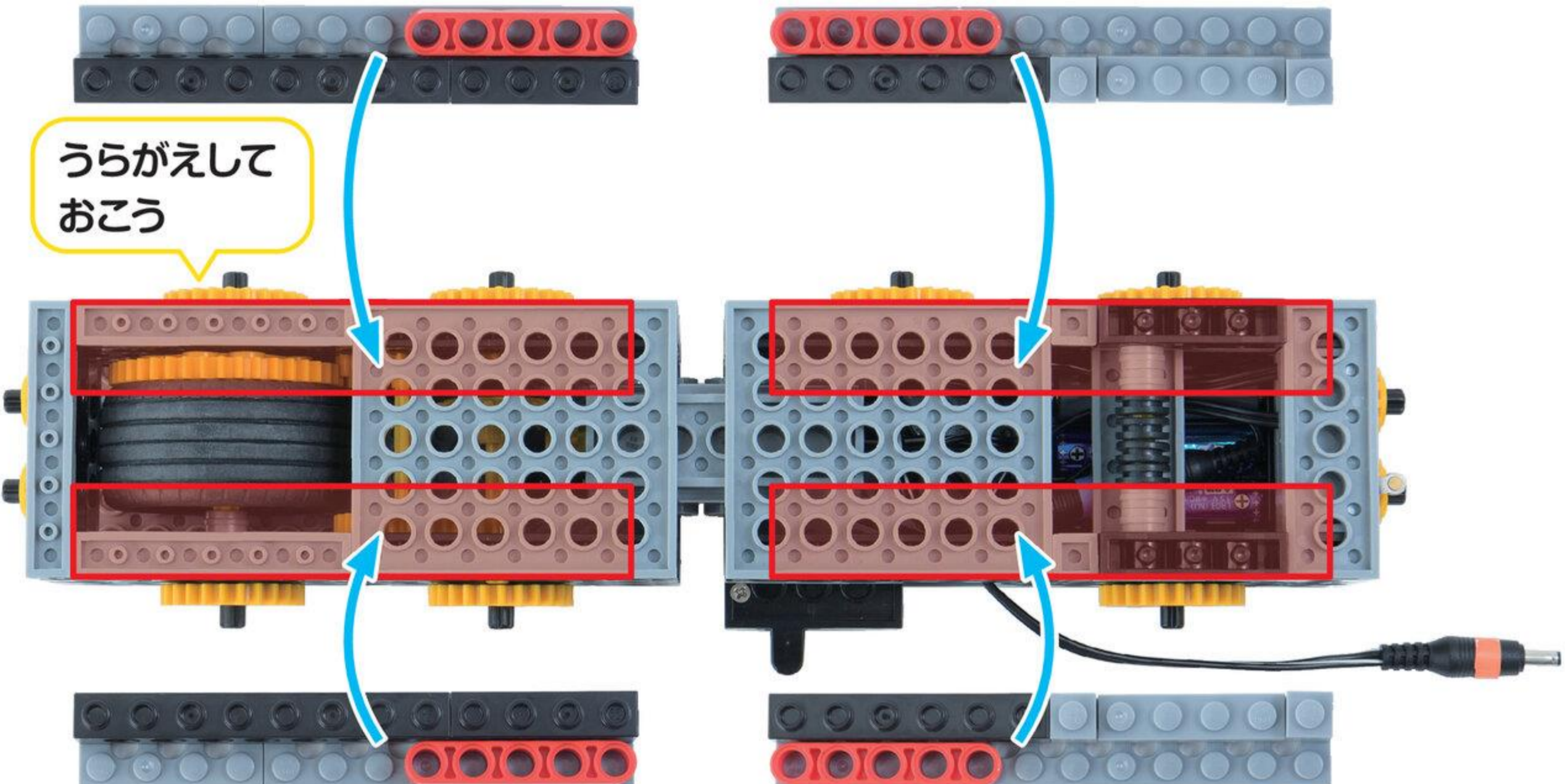

うらがえして
とりつけよう



れえる
レールのうえを
はしれるようになったよ!

やったね!

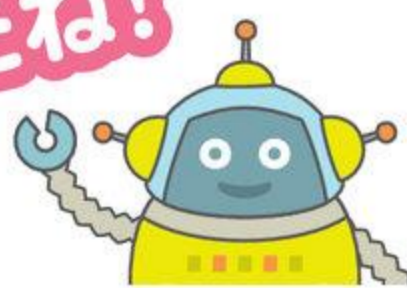

3

れ える
レール

めやす 20 ぶん

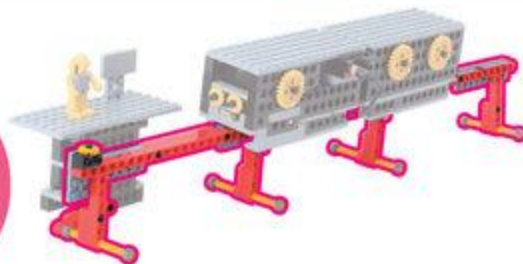

てい るっど
T ロッド 1こ

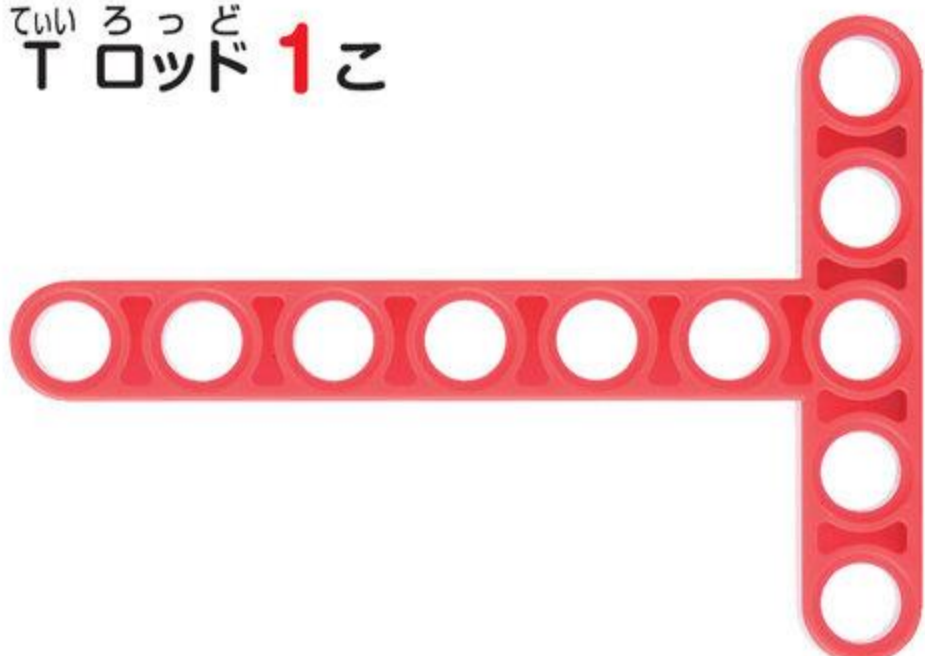

るっどさんあな
ロッド3アナ 1こ



しゃふとぺぐ
シャフトペグ 1こ



1



れ える
レールのいちばんまえをつくるよ

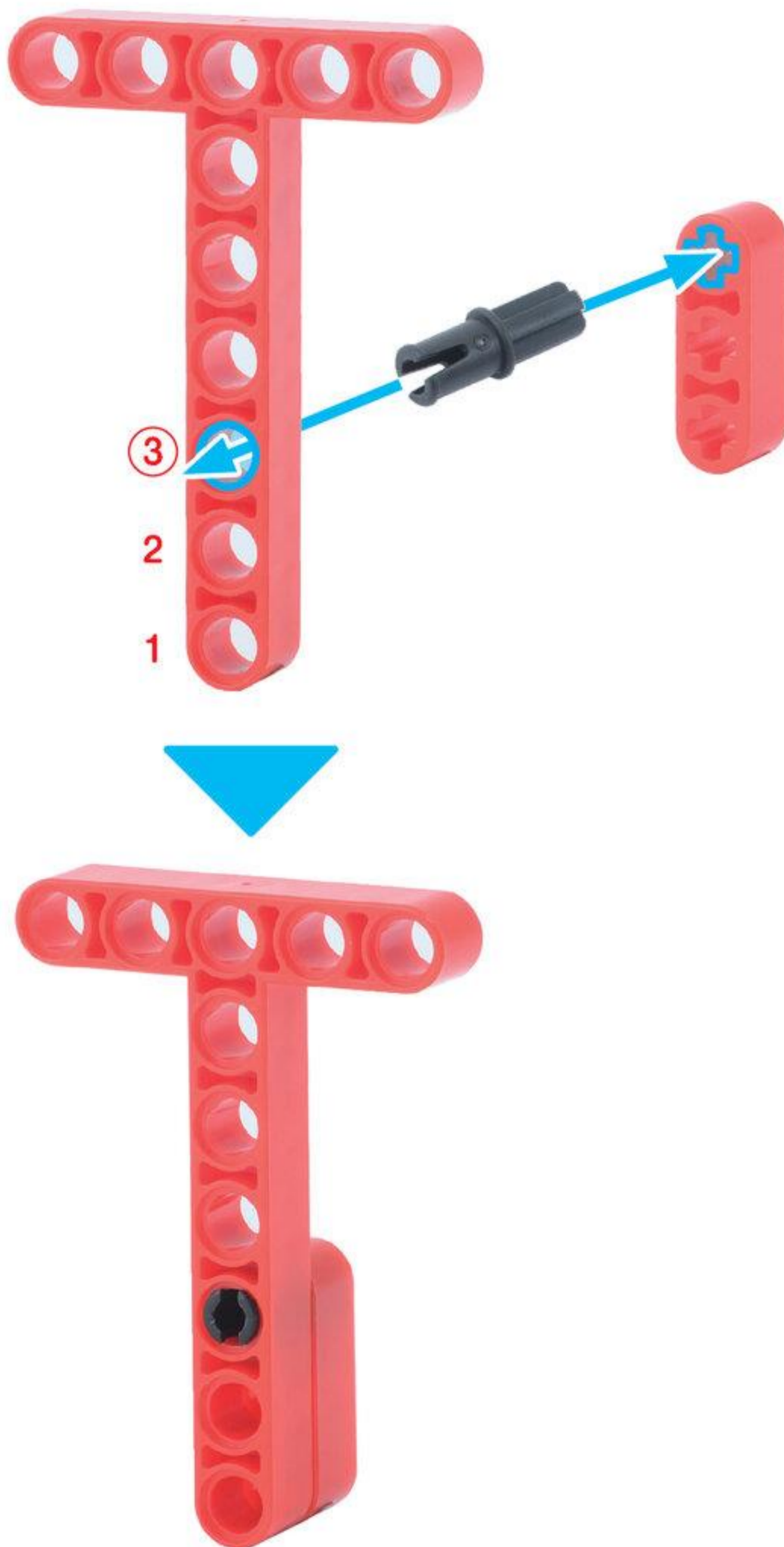

ろっどごあな
ロッド5アナ 1こ



くらんく
クランク 1こ

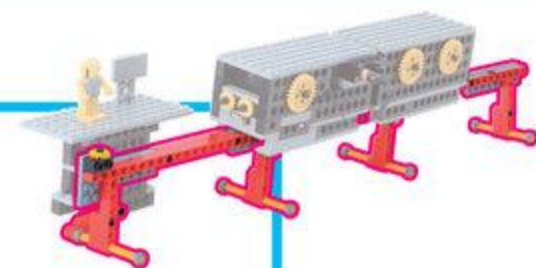

2

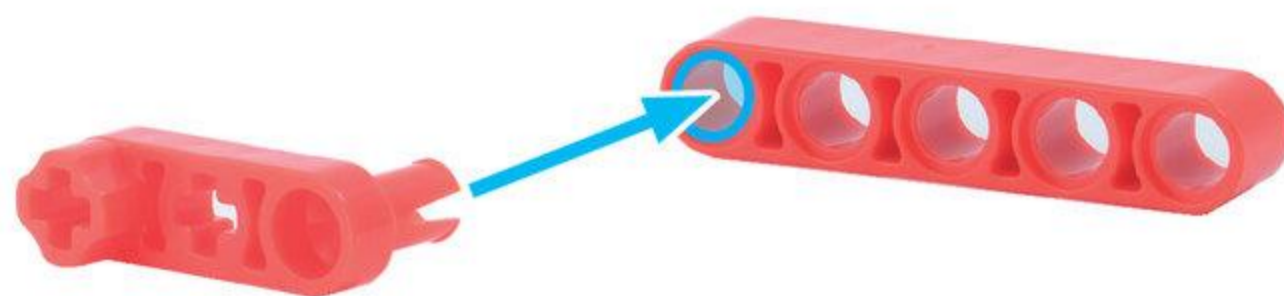

シャフト 8 ポチ 1こ



ながさに
ちゅうい

ぶっしゅ 2こ

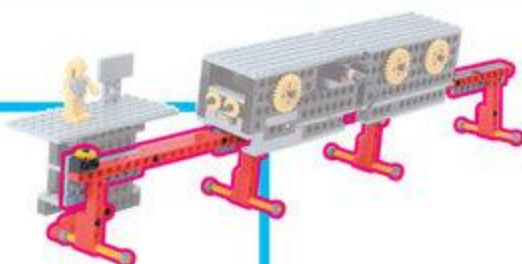

3



ふとぶれえとろくぼち
太プレート6ポチ 1こ



ほそぶれえとろくぼち
細プレート6ポチ 1こ

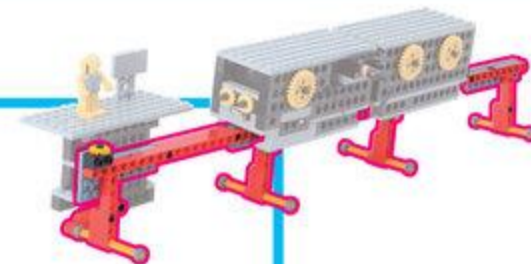

4

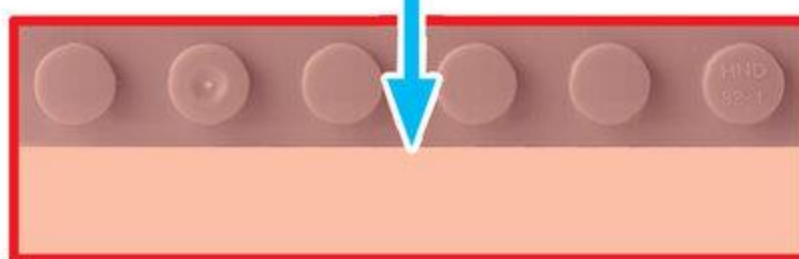

うらがえして
みたところだよ

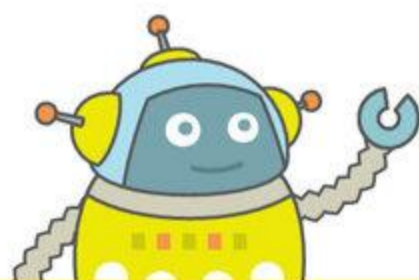

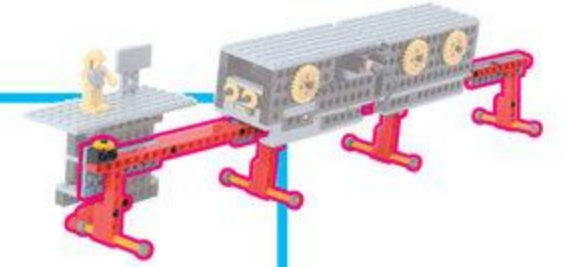

ふとぶれえとよん ぼち
太プレート 4 ポチ 1 こ



まいたぎあ
マイタギア 1 こ



しゃふとびいむに ぼち
シャフトビーム 2 ポチ 1 こ



くろしゃふと ぼち
黒シャフト 1.5 ポチ 1 こ



5

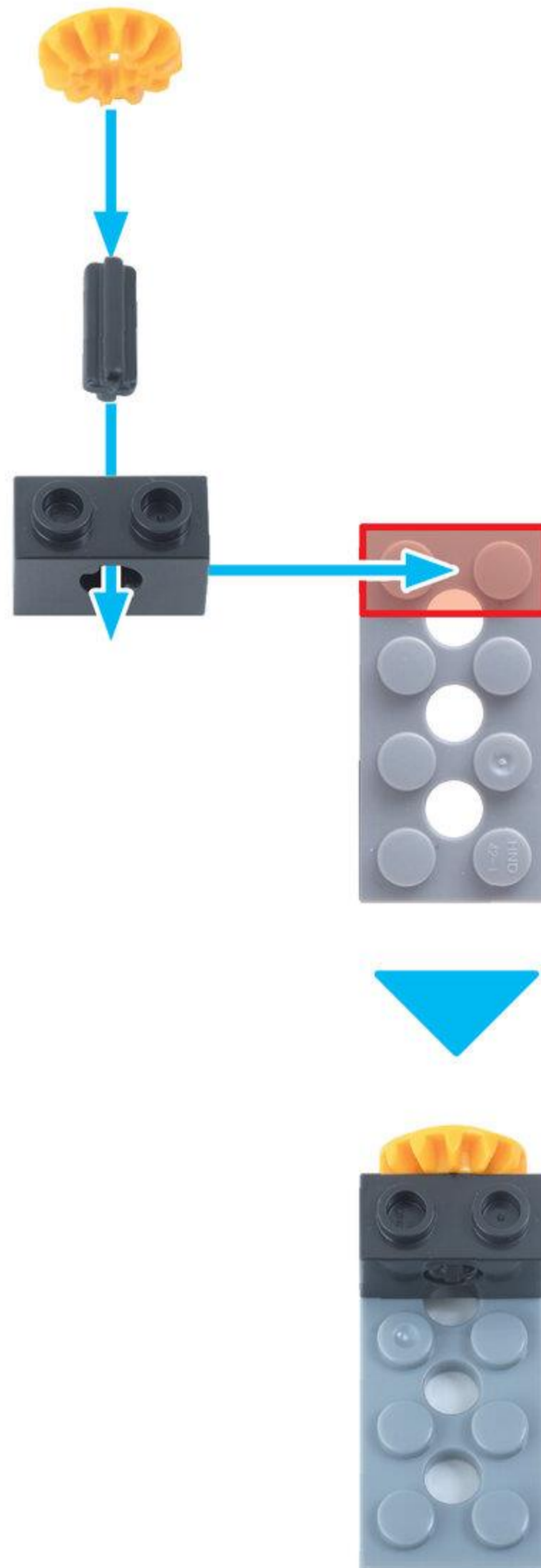

6

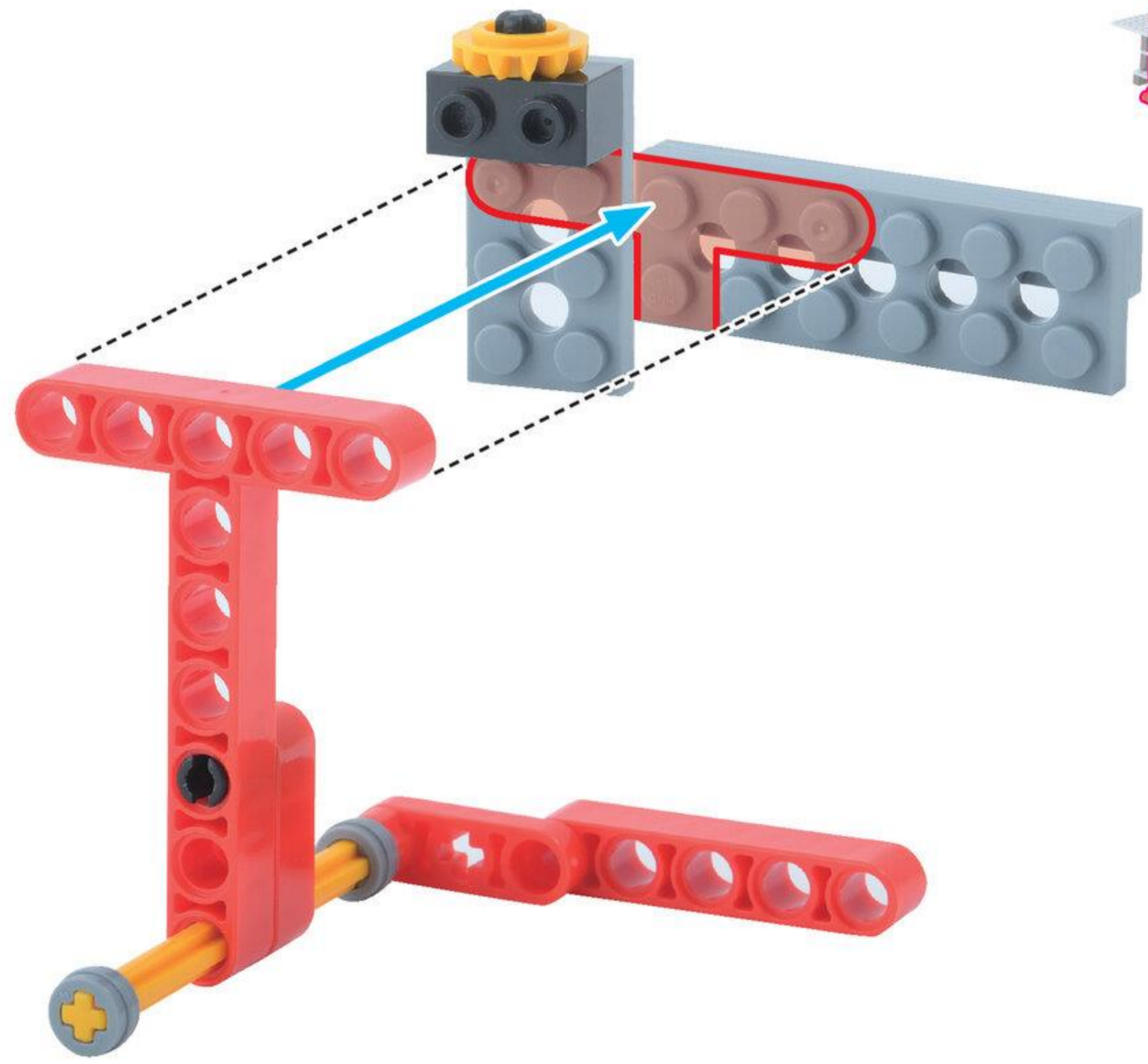
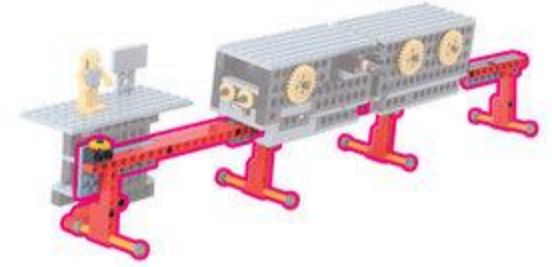

れえる
レールの
いちばんまえが
かんせい!



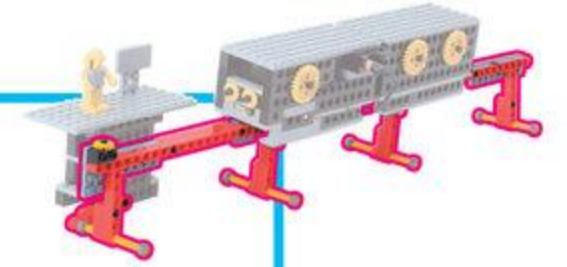

てい ろっど
T ロッド 1こ

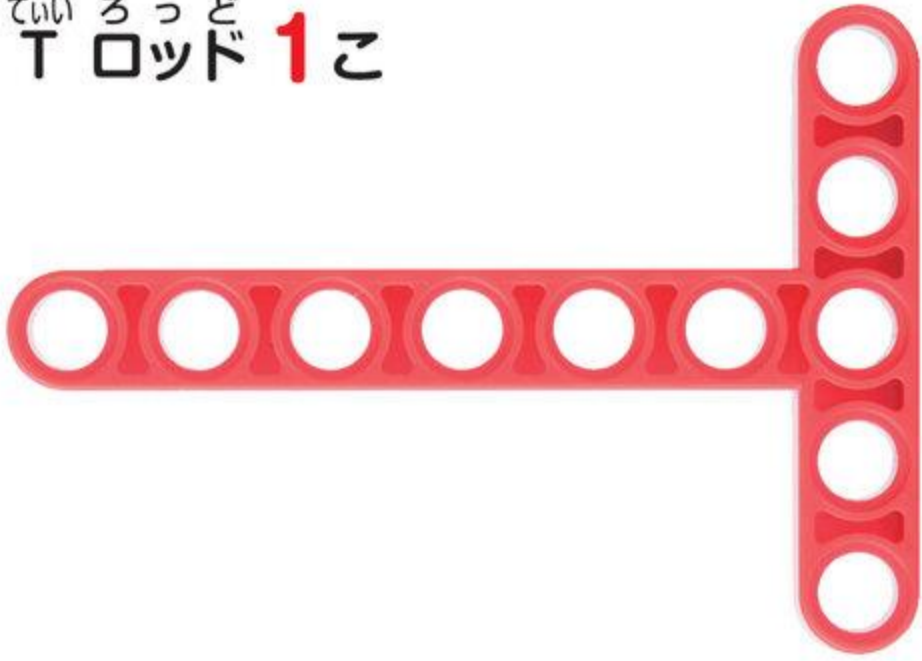

ろっどさんあな
ロッド3アナ 1こ



しゃふとべぐ
シャフトペグ 1こ



7

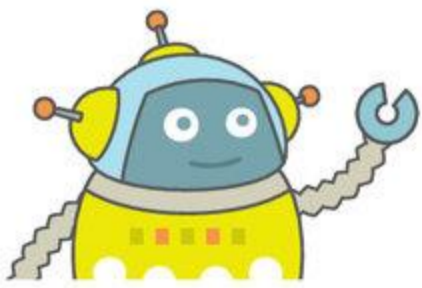

れえる
レールのいちばんうしろをつくるよ

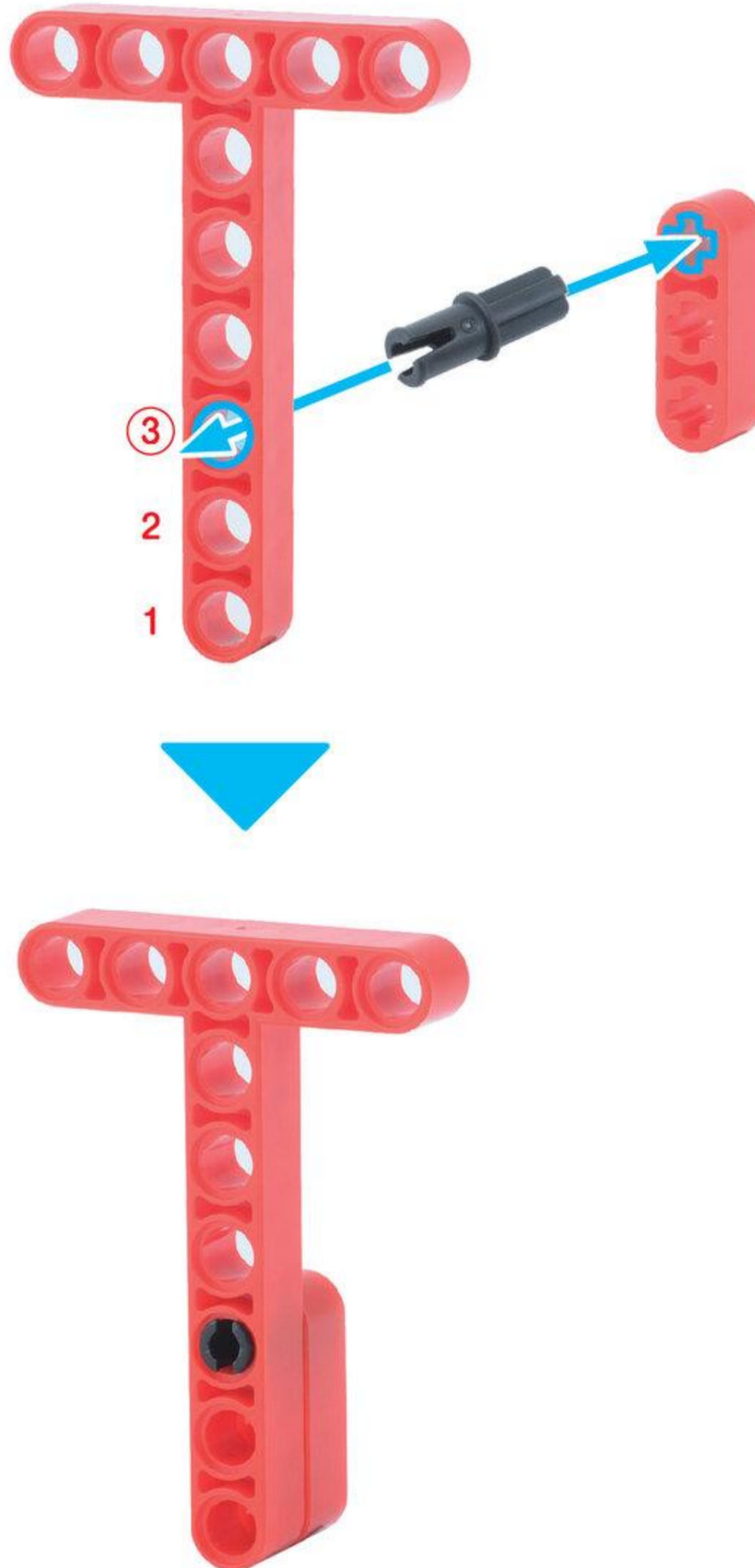

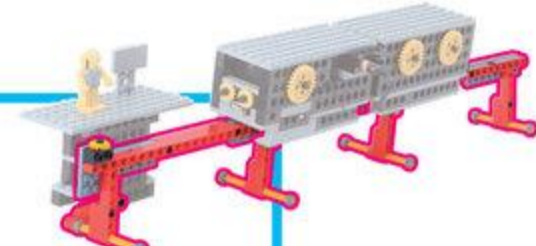

ふとぶれえとはちほち
太プレート 8 ポチ 1 こ



ほそぶれえとにほち
細プレート 2 ポチ 1 こ



ほそぶれえとろくほち
細プレート 6 ポチ 1 こ



8

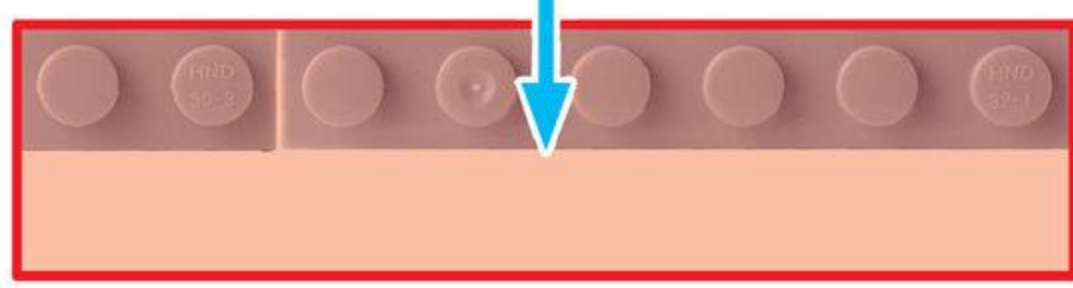
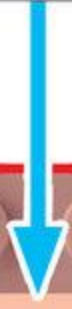

うらがえして
みた ところだよ

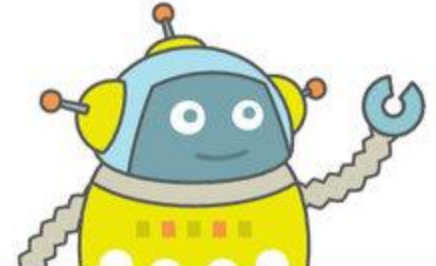

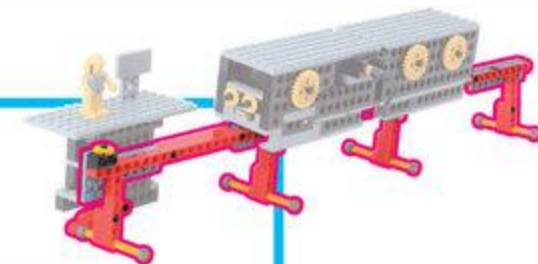

ろっど^{じゅうご} 15 アナ^{あな} 1こ



ろっど^{きゅう} 9 アナ^{あな} 1こ



ペグ^{へぐ} S^{えす} 2こ



9

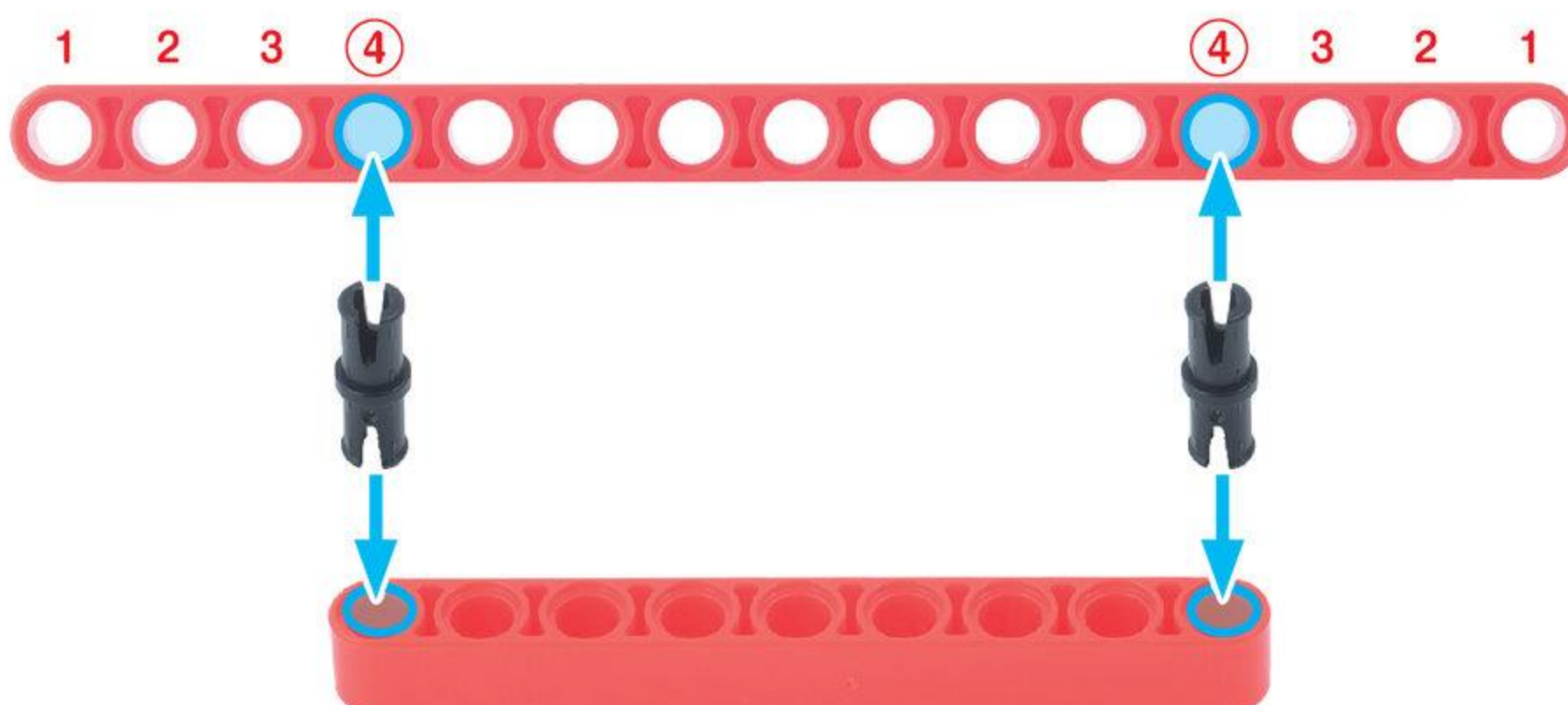

10

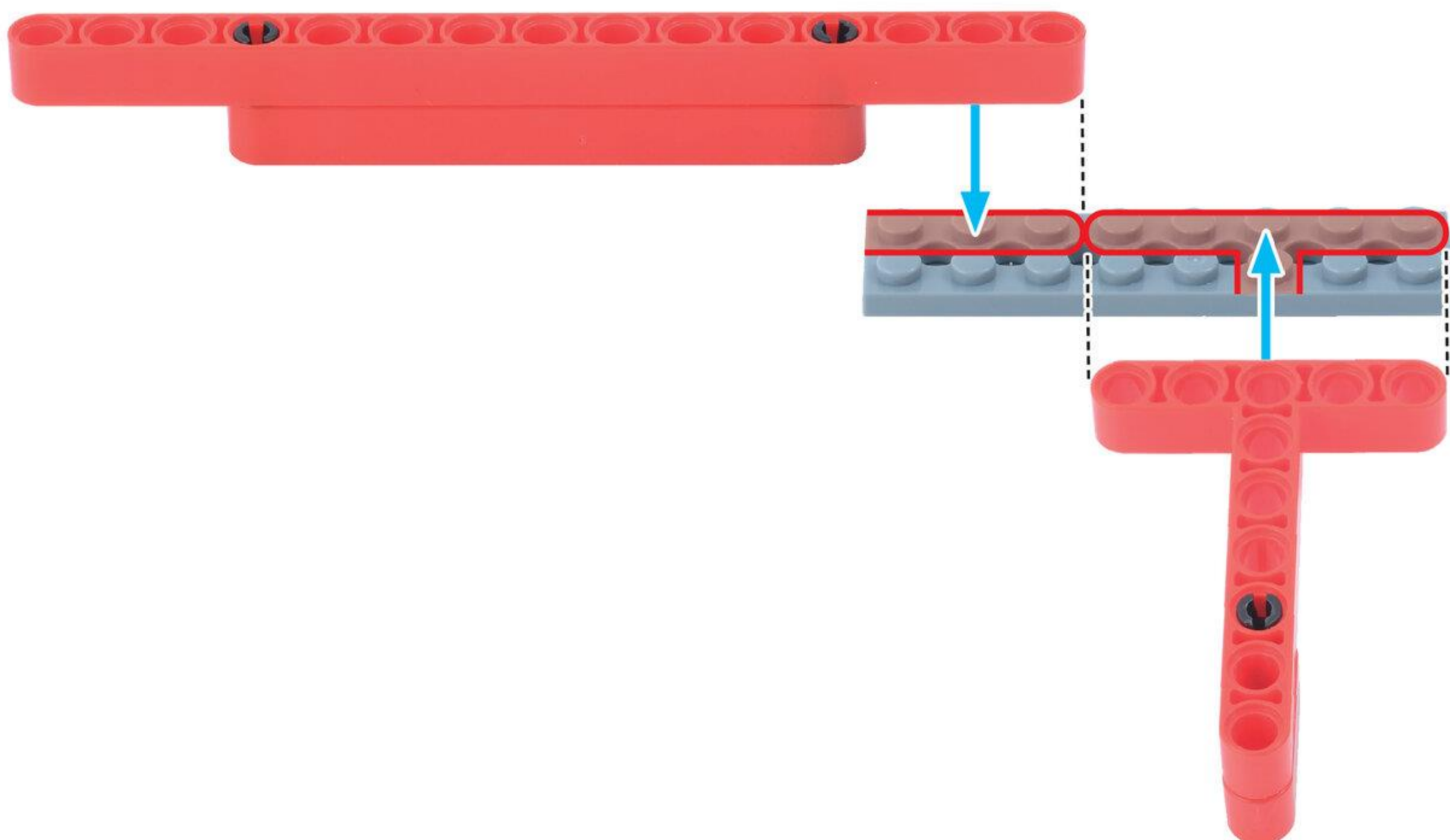
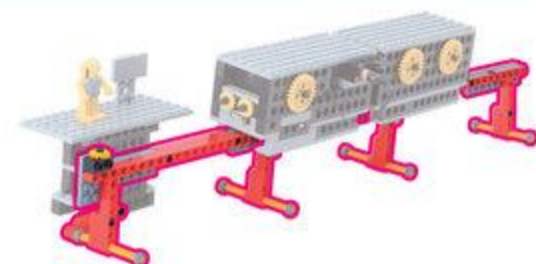

しゃふとはちぼち
シャフト 8 ポチ 1こ



ながさに
ちゅうい

ぶっしゅ
ブッシュ 2こ

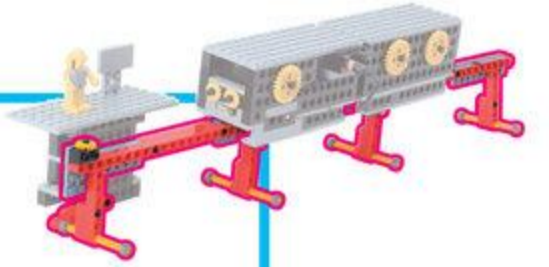

11

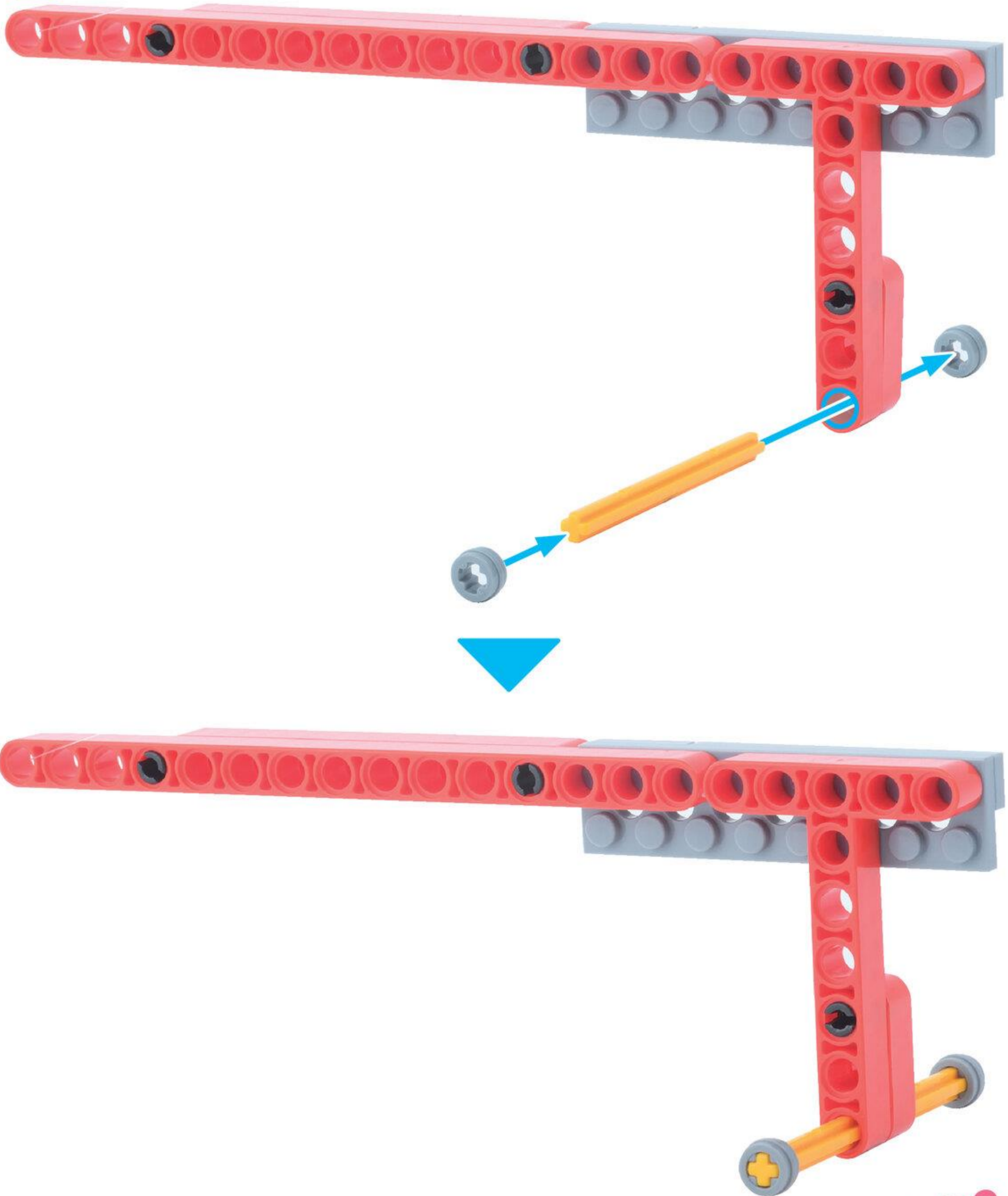

れえる
レールの
いちばんうしろが
かんせい!

やったね!

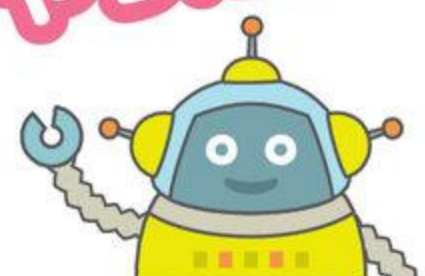

ろっど なあな
ロッド7アナ 1こ



くらんく
クランク 1こ

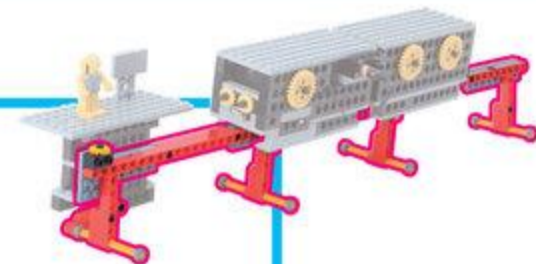

12

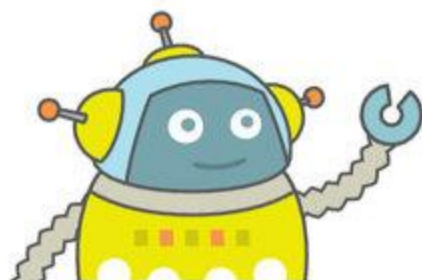

れえる
レールの まんなかをつくるよ

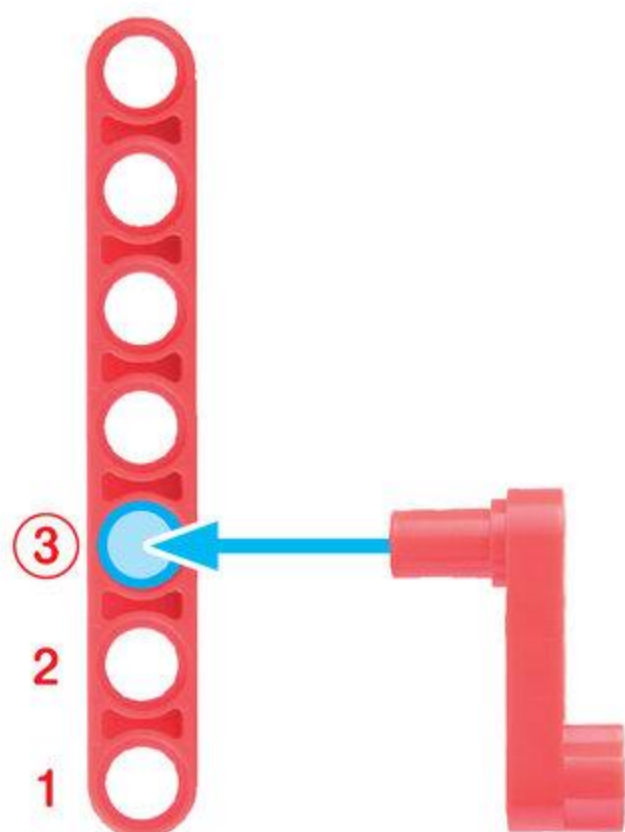

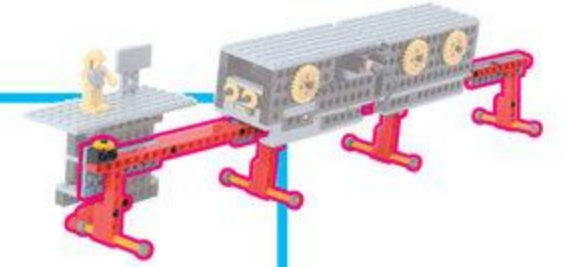

ふとぶれえとはちぼち
太プレート 8 ポチ 1 こ



ほそぶれえとにぼち
細プレート 2 ポチ 1 こ



ほそぶれえとろくぼち
細プレート 6 ポチ 1 こ



13

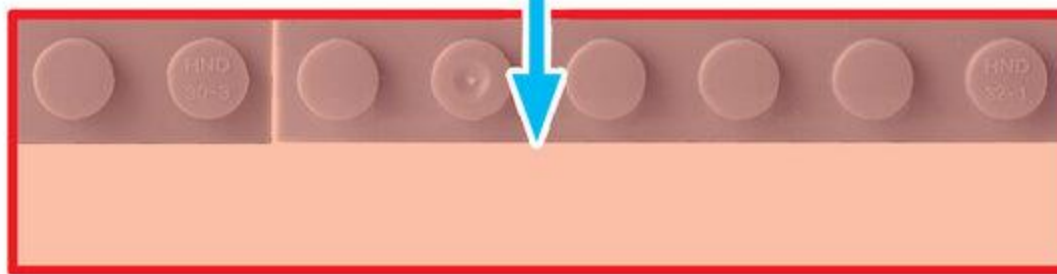

うらがえして
みた ところだよ

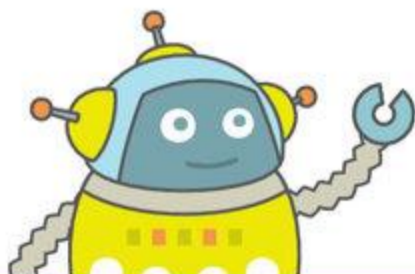

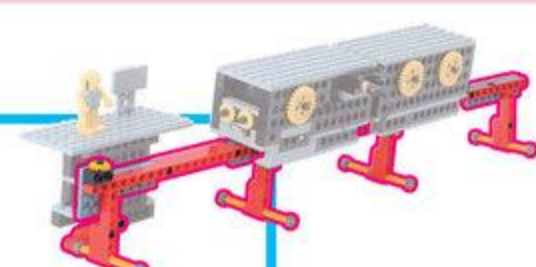

ろっど じゅうご あな **1**こ
ロッド 15 アナ

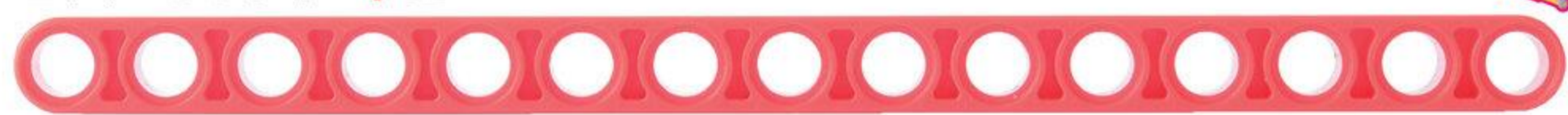

ろっど きゅう あな **1**こ
ロッド 9 アナ



ペグ へい **2**こ
ペグ S



14

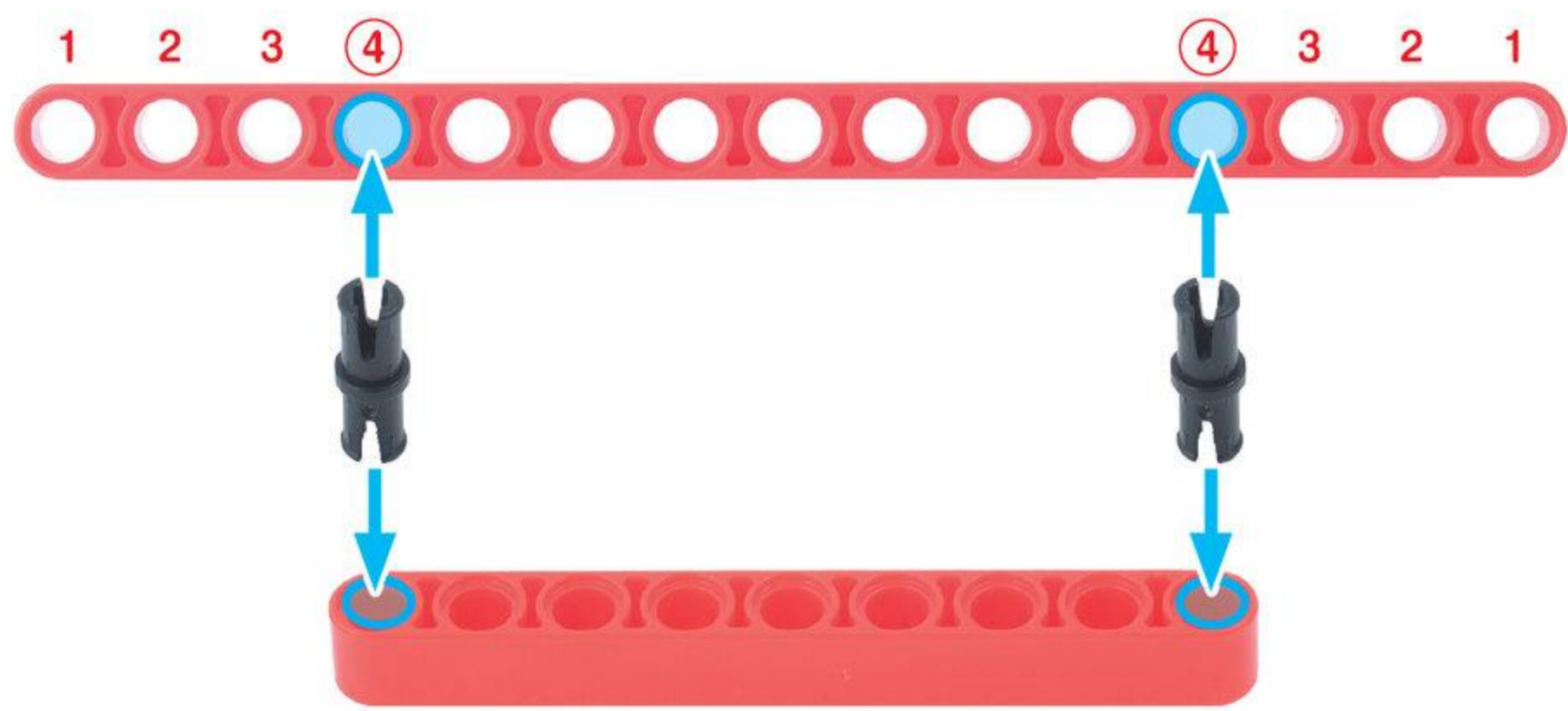

くろすじょいんと
クロスジョイント 1こ

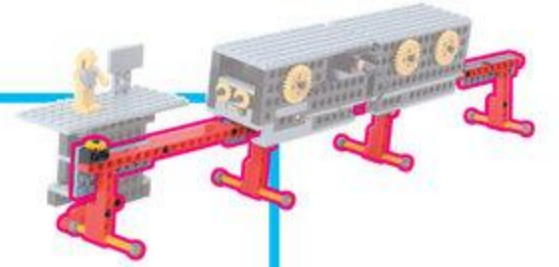

15

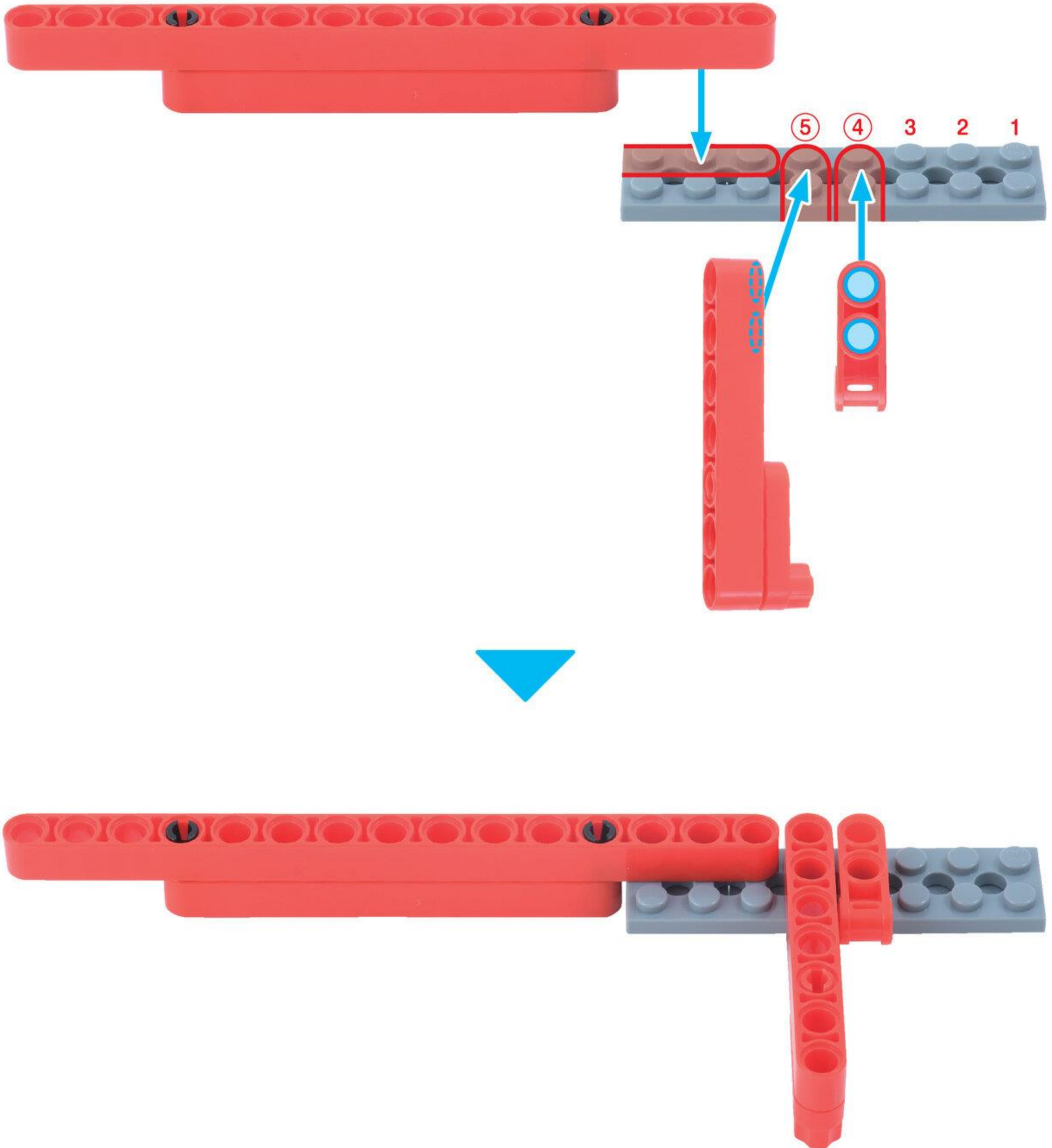

シャフト 8 ポチ 1こ



ながさに
ちゅうい

ぶっしゅ 2こ

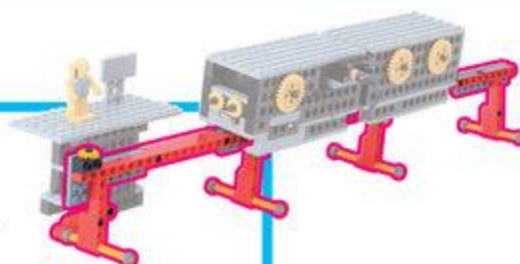

16

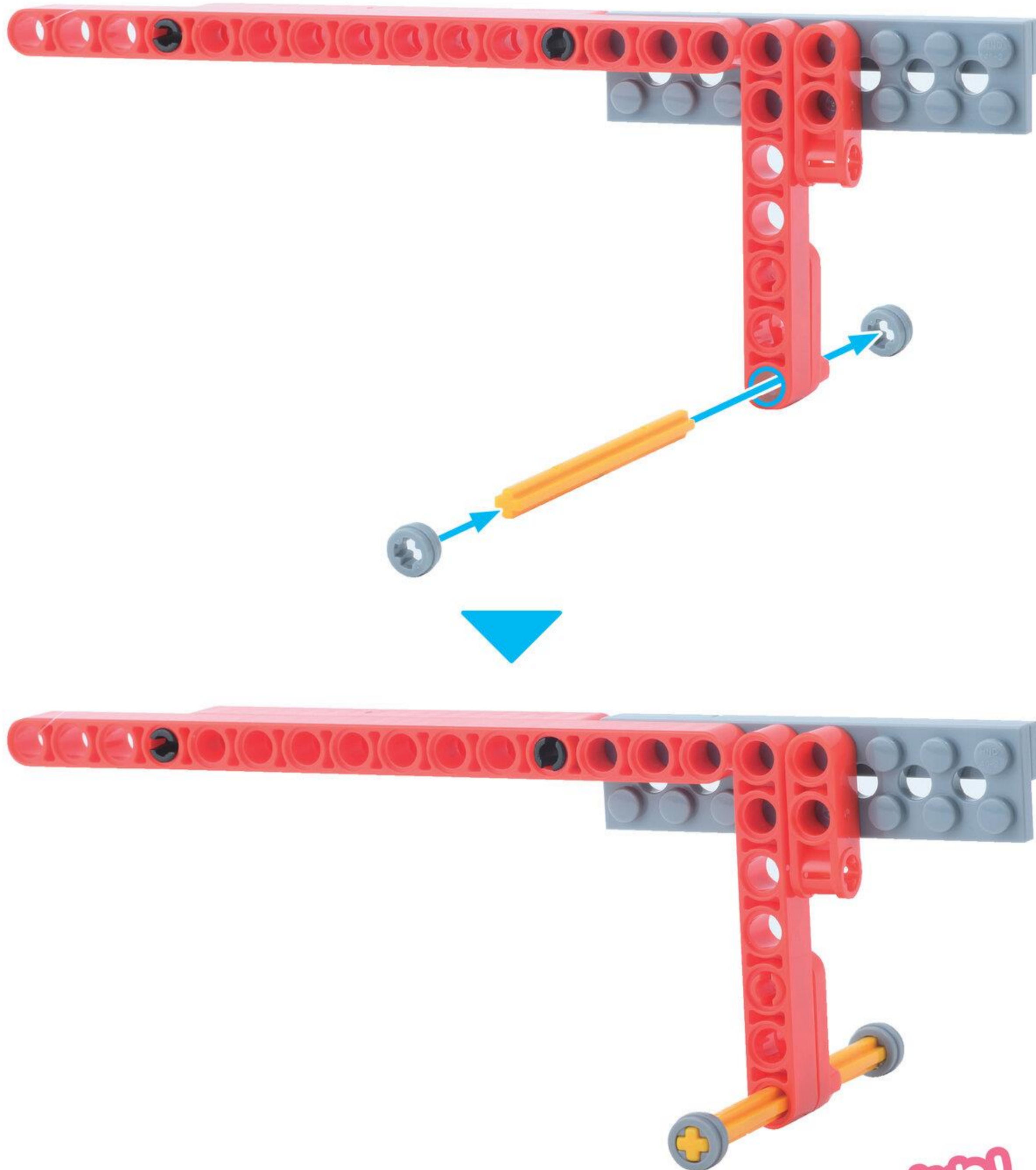

れえる
レールの
まんなか
1つ かんせい!



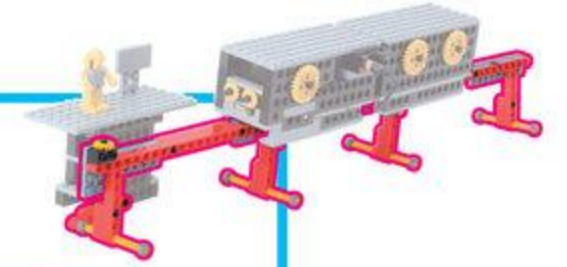

ろっど^{じゅうご}アナ 1こ
ロッド 15 アナ 1こ



ろっど^{きゅう}アナ 1こ
ロッド 9 アナ 1こ



ペグ^すS 2こ



ろっど^なアナ 1こ
ロッド 7 アナ 1こ



くらんく 1こ



ふとぶれえとはちぼち
太プレート 8 ポチ 1こ



くろすじょいんと
クロスジョイント 1こ



ほそぶれえとにぼち
細プレート 2 ポチ 1こ



ほそぶれえとろくぼち
細プレート 6 ポチ 1こ



しゃふとはちぼち
シャフト 8 ポチ 1こ



ながさに
ちゅうい

ぶっしゅ 2こ



17

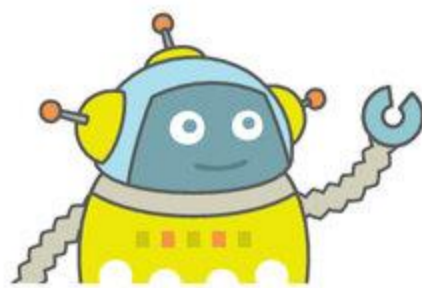

うえの^{ばあつ}パーツをつかって
71 ページにもどって もう1つ つくろう!



18

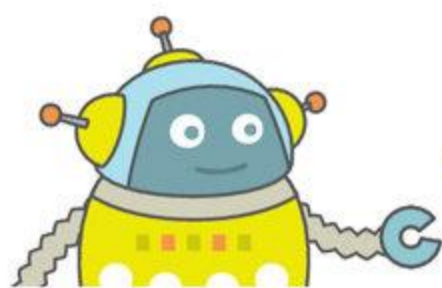

かんせいした^{れえる}レールをつなごう!
まずは まんなかの 2 つをつなぐよ

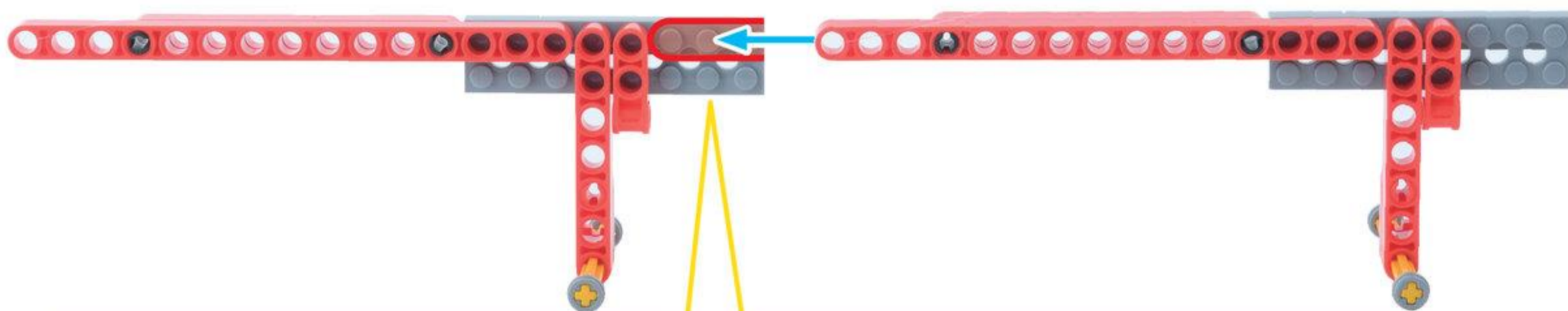
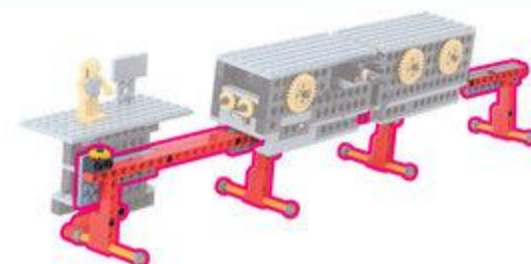

おおきくして
みた ところだよ

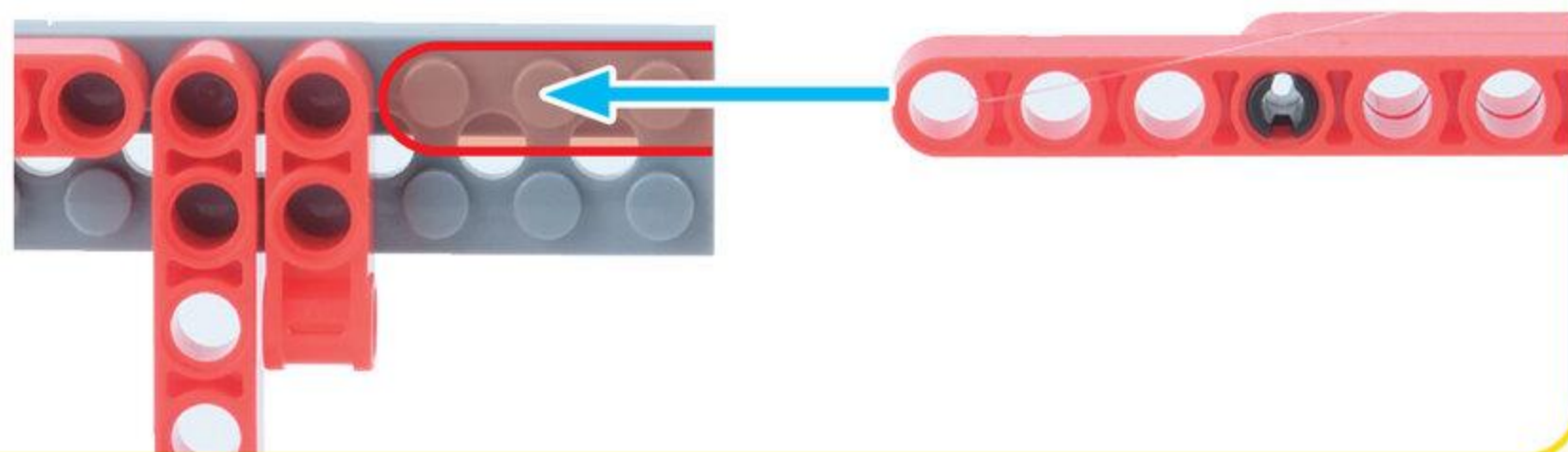
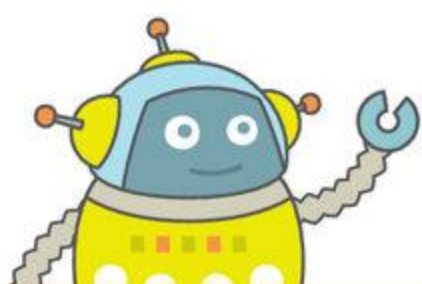

おおきくして
みた ところだよ

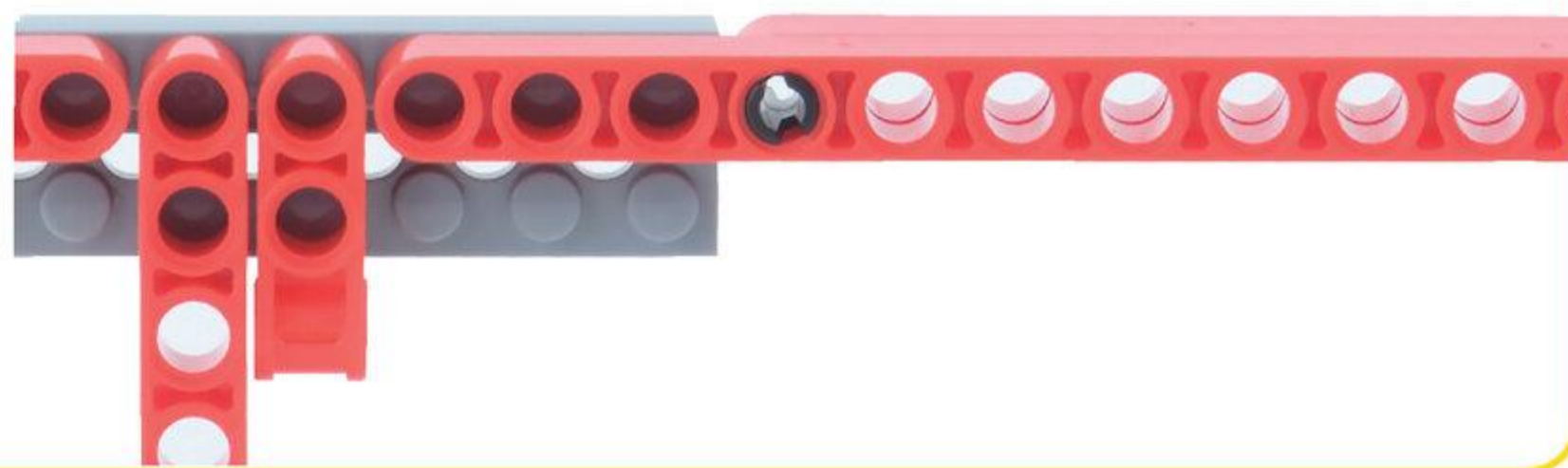
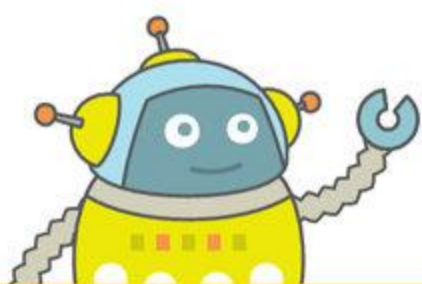

19

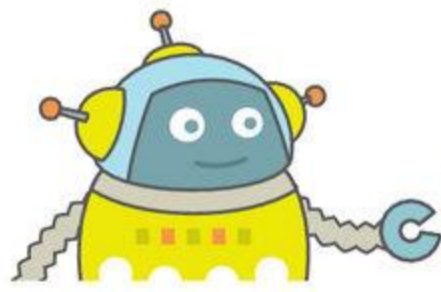

れ える
レールの いちばんまえをつけるよ!

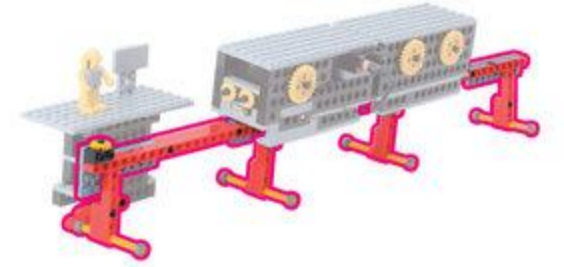

おおきくして
みた ところだよ

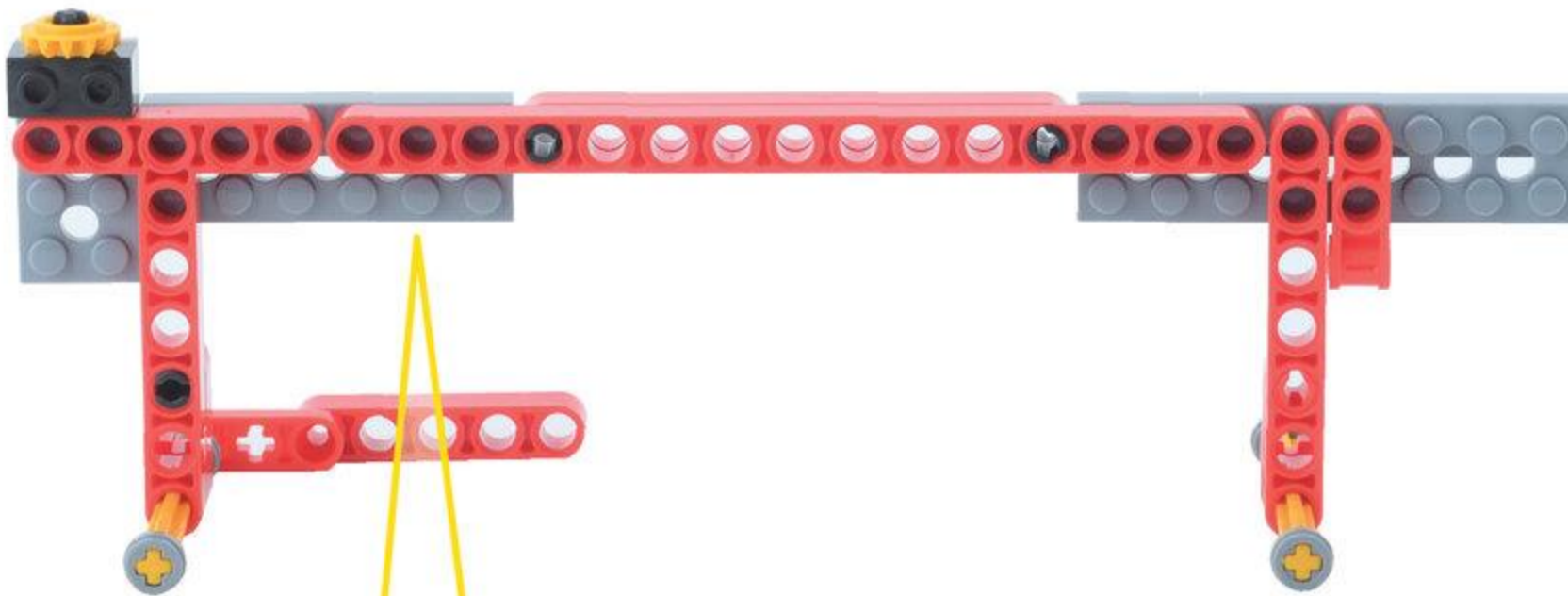
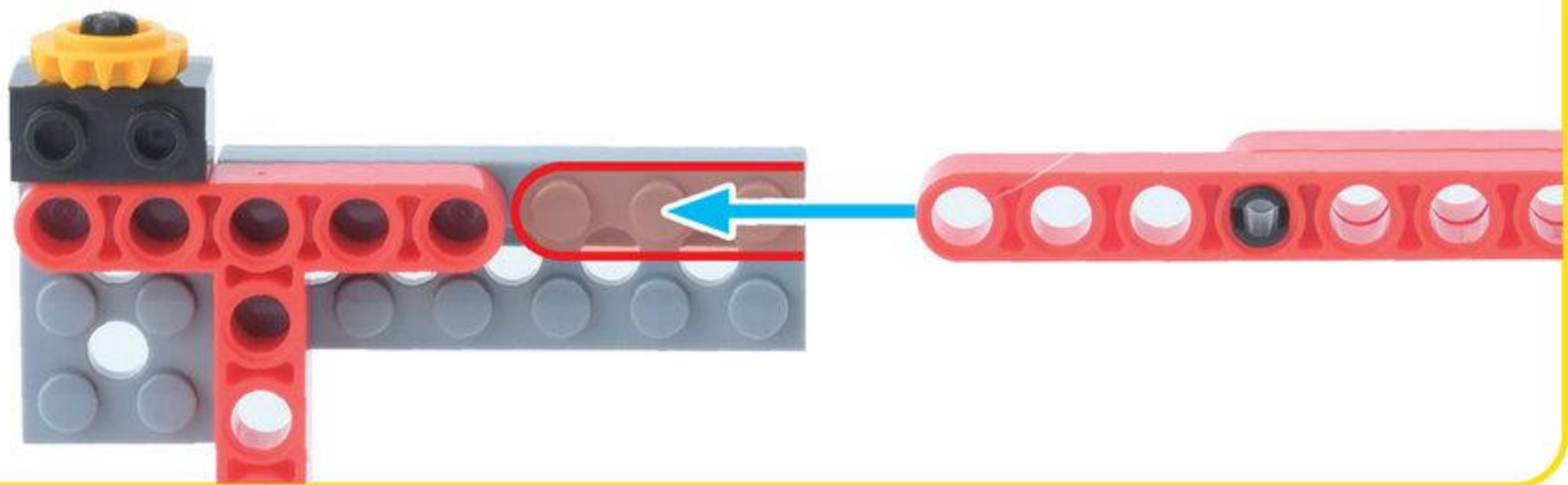
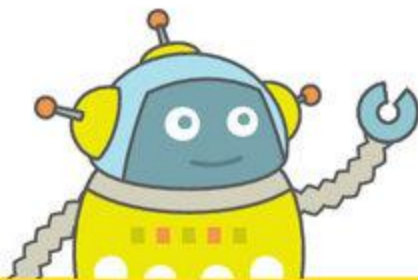

おおきくして
みた ところだよ

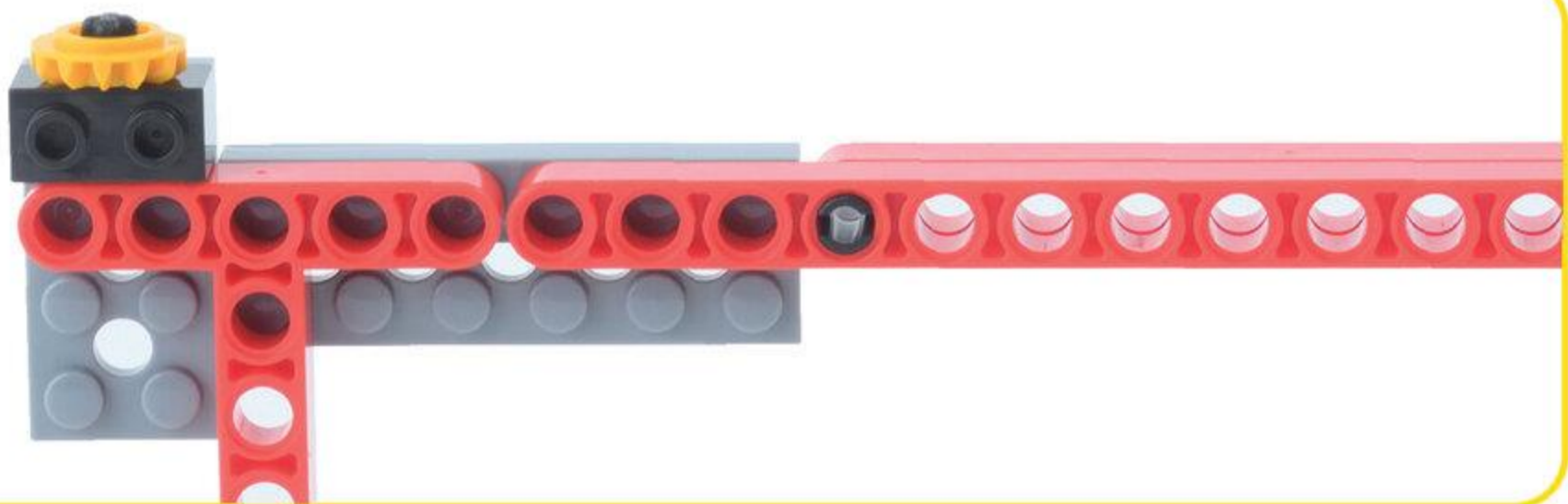
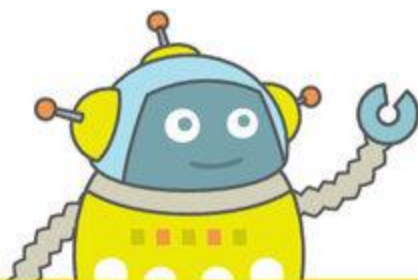

20

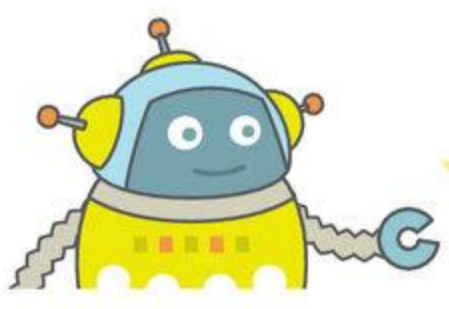

れ える
レールの いちばんうしろをつけるよ!

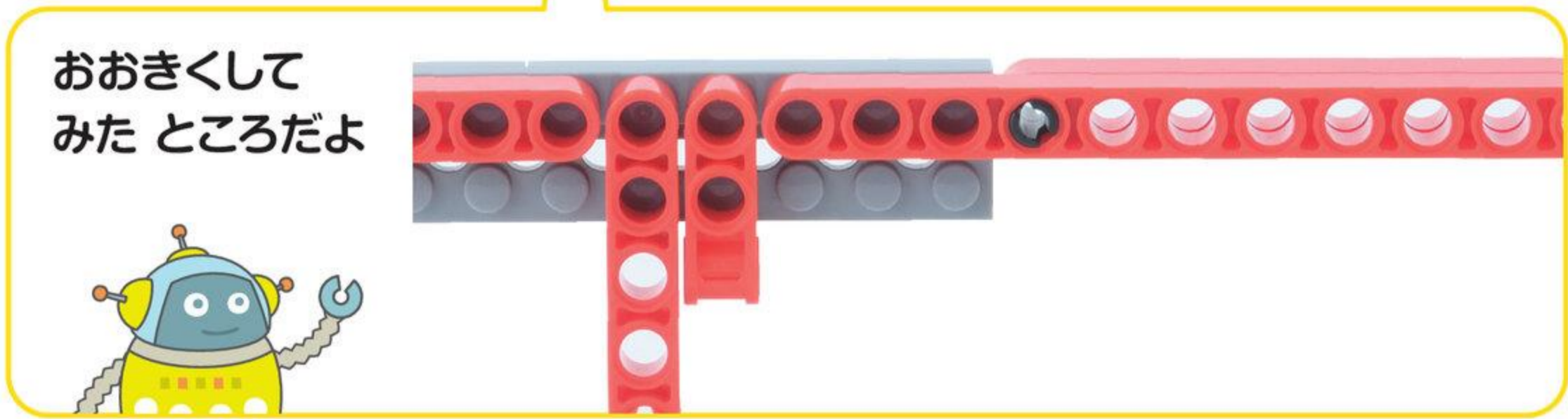
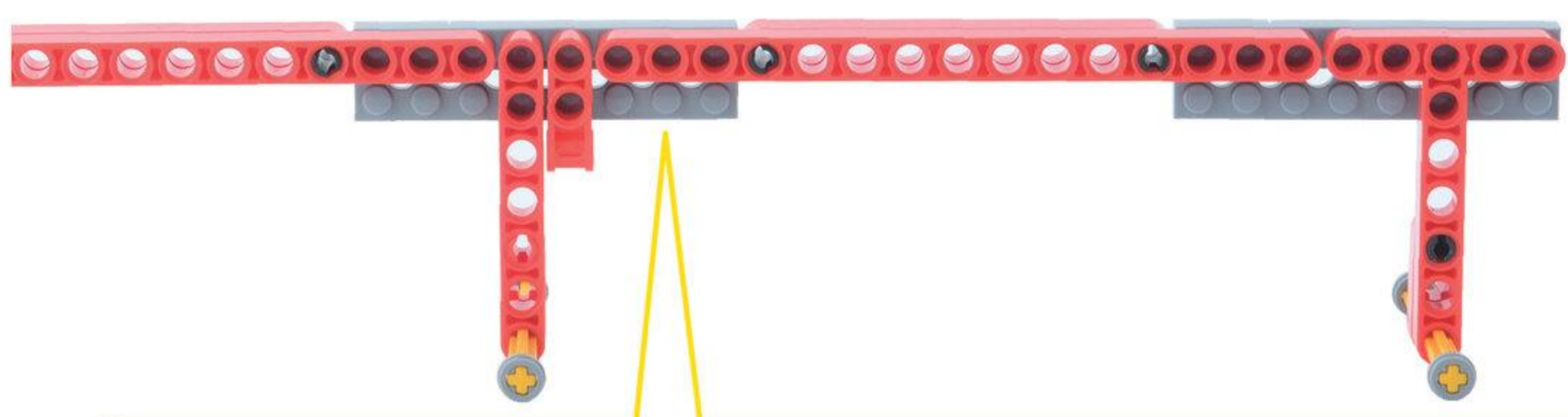
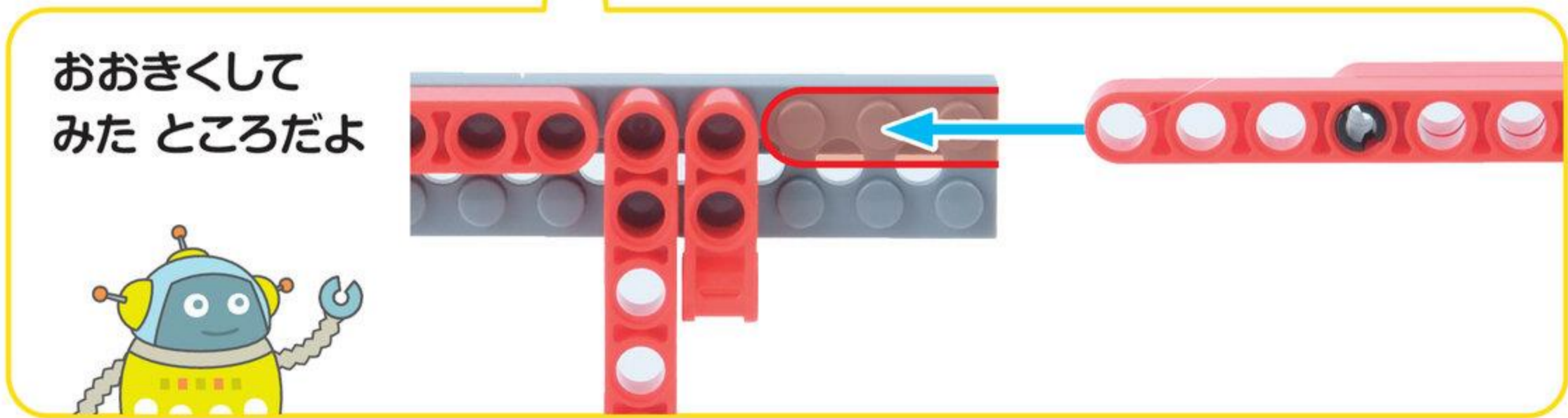
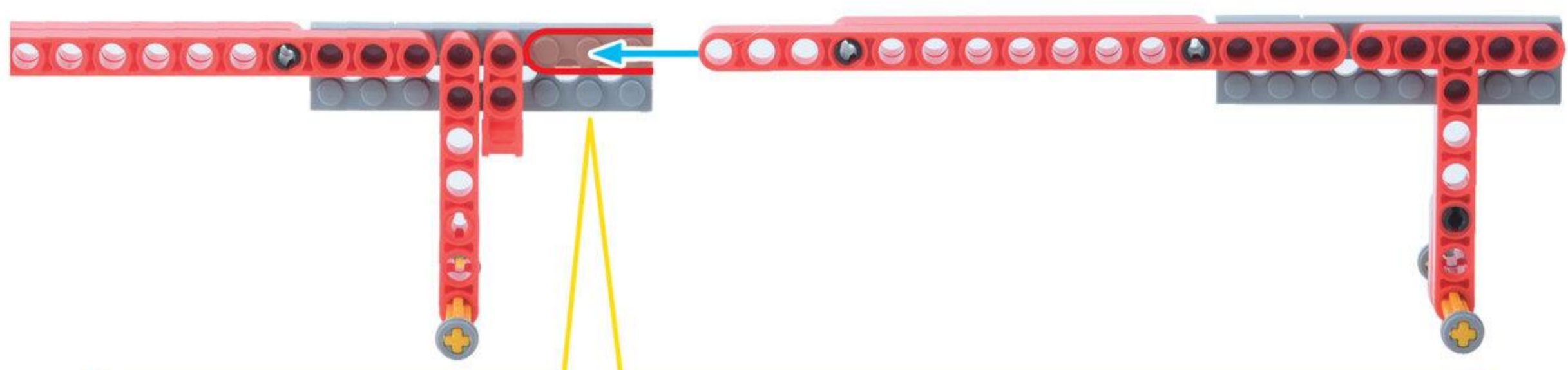
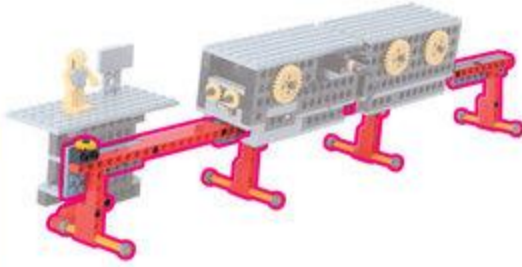

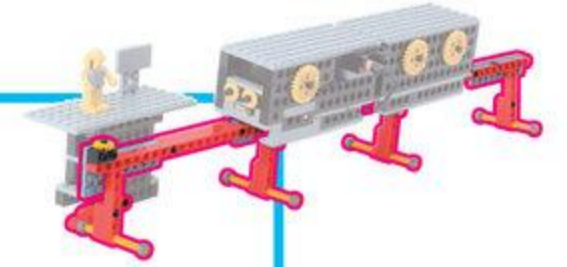

こ 1 S 対 ぐ へ



21

えきを
つけるよ!

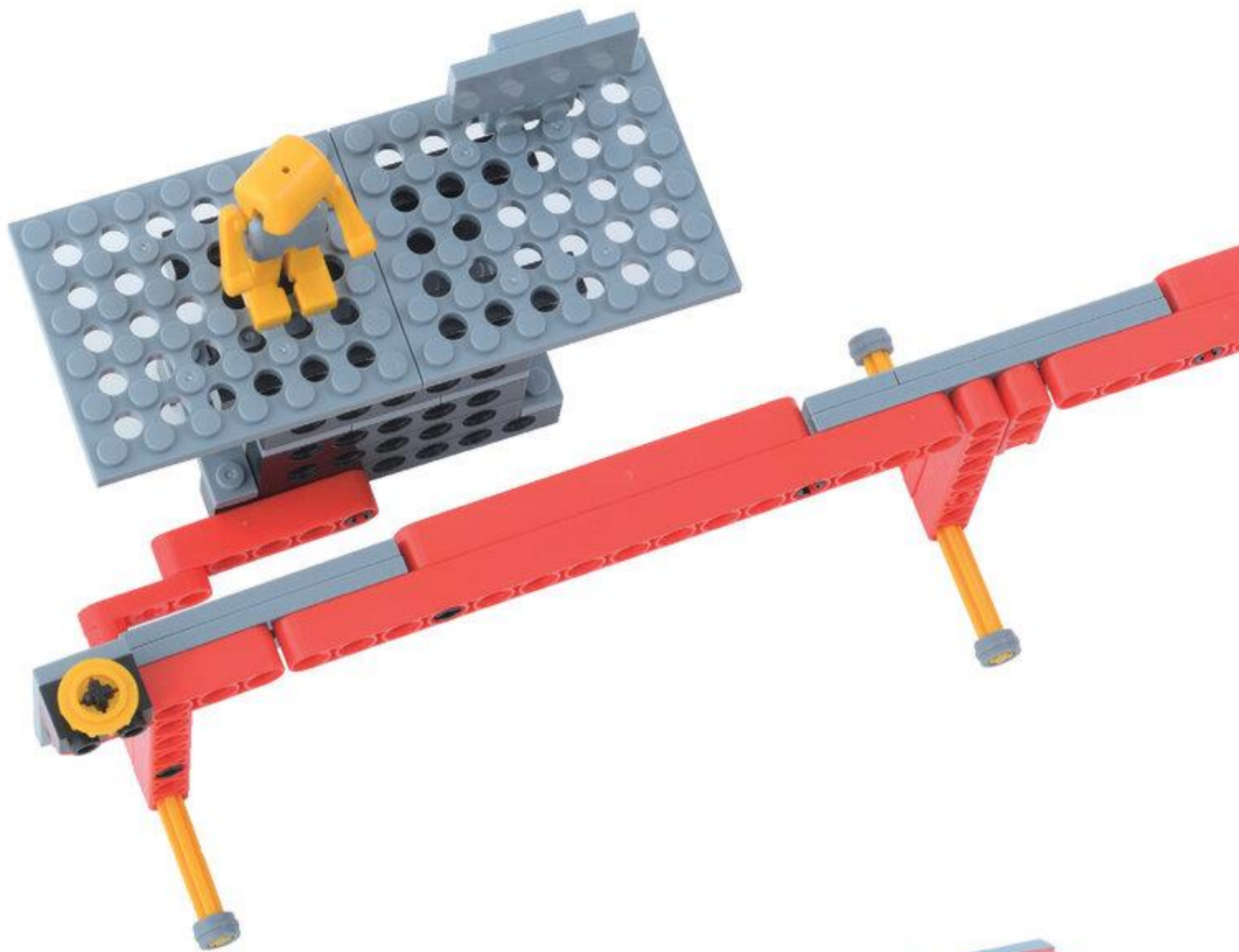
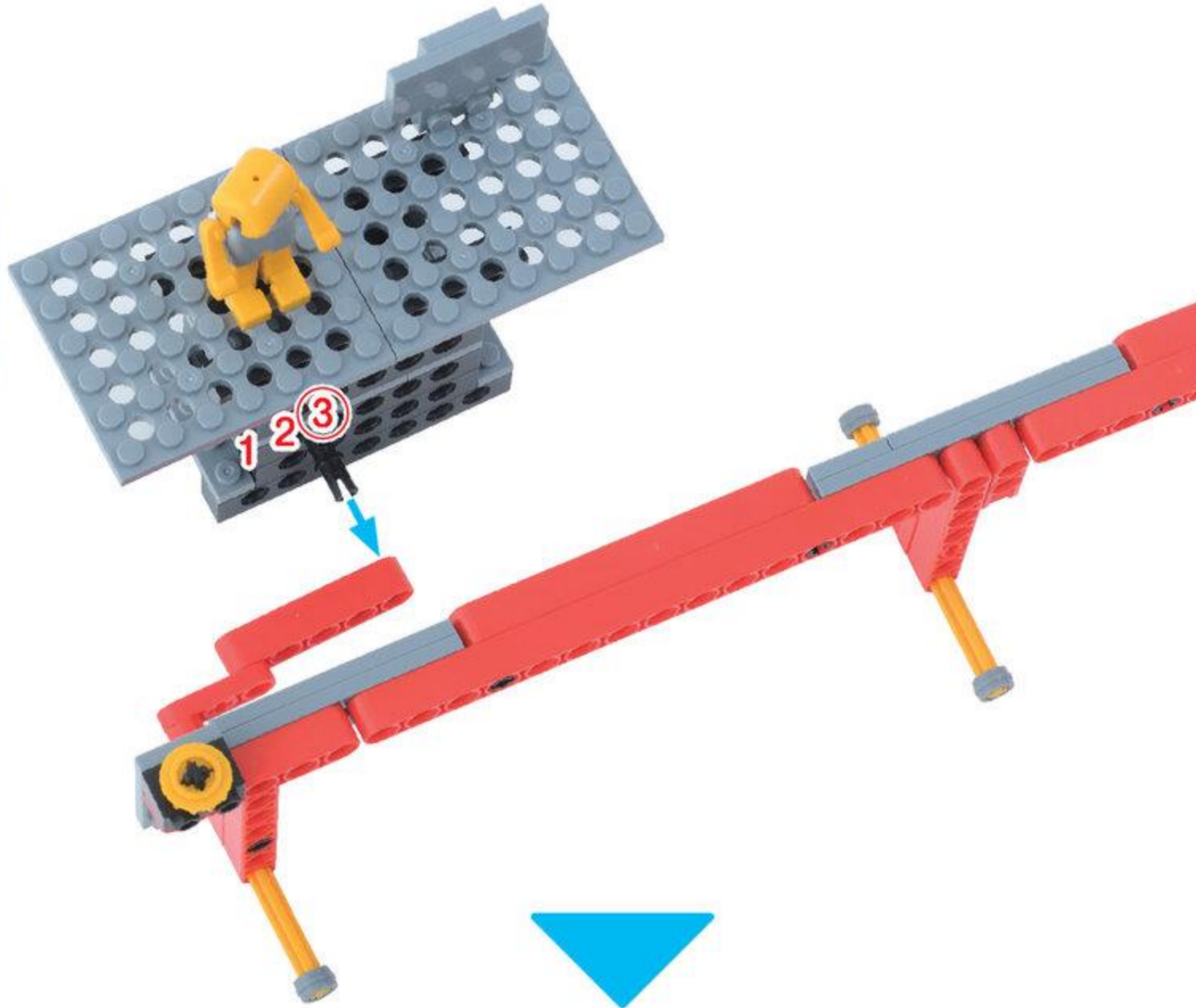
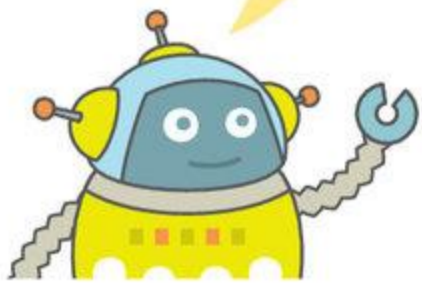

これで
かんせい!

よくできました!

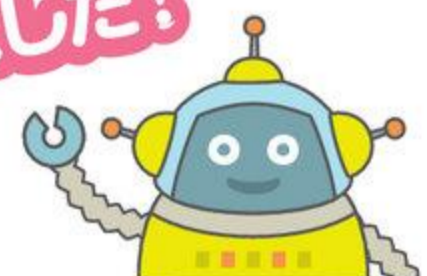

ロボットをうごかそう

めやす 5 ぶん

コードをつなごう

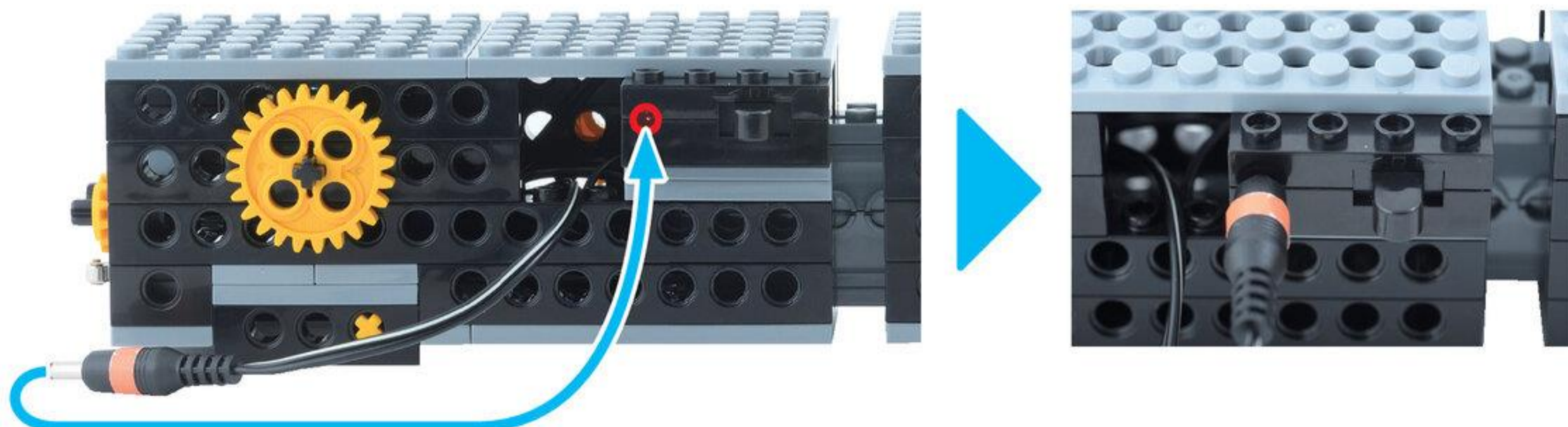

レールにのせよう



レールガイドの
あいだに
レールを
はさむように
のせよう!

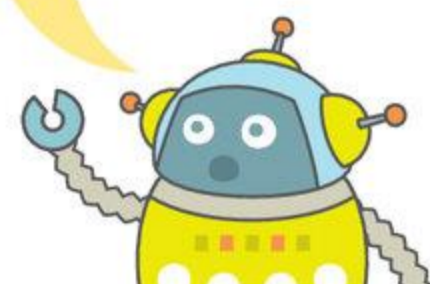

スイッチをいれてうごかそう

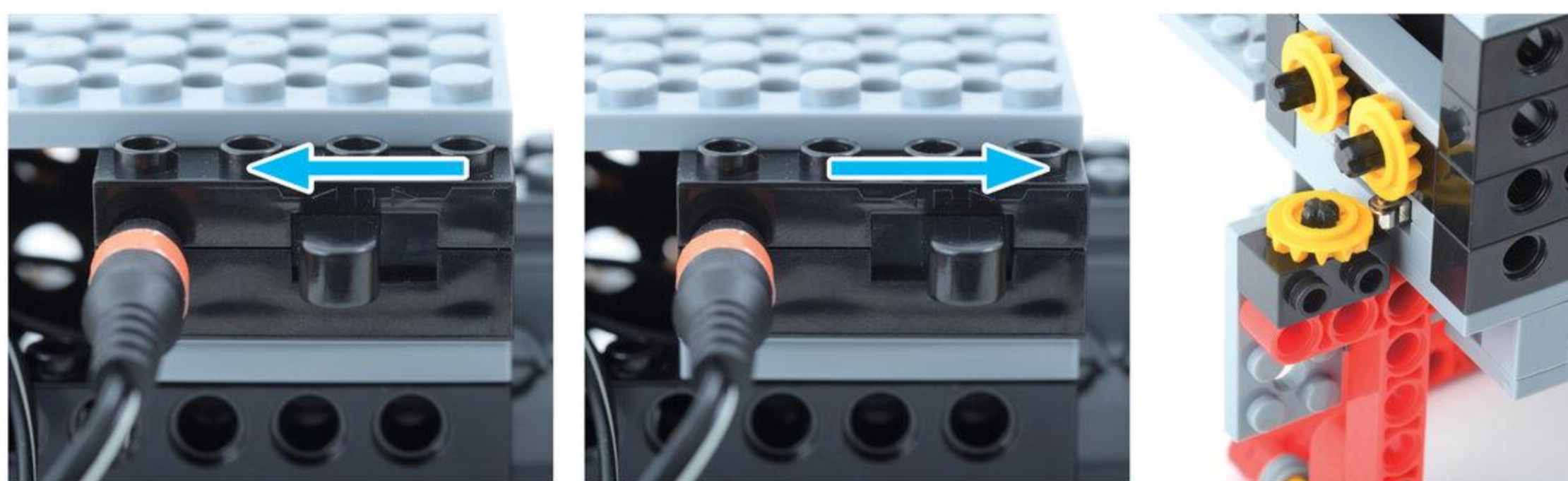

レールの
はしまでいくと
じどうきにとまるよ!

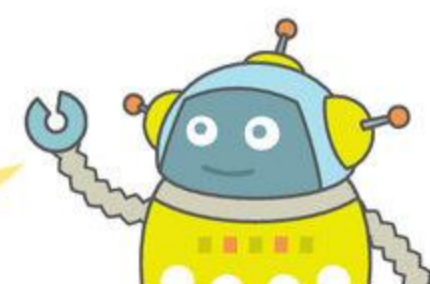

じゆうにかいぞうしてみよう

めやす 30 ぶん



あまった^{ばあっ}パーツで
まんなかの^{れえる}レールは
あと3つ^{れえる}つくれるよ!
レールをながくしてみよう!

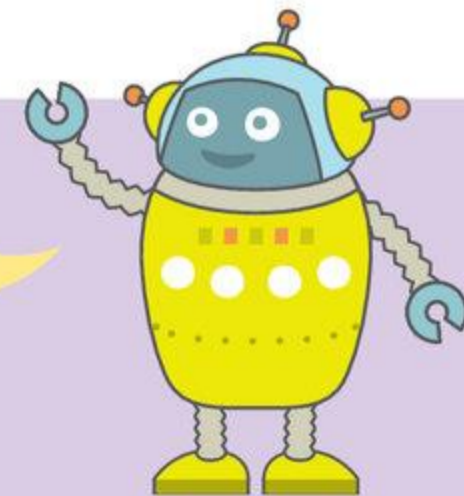

あまった^{ばあっ}パーツで
えきをかいぞう
してみたよ!

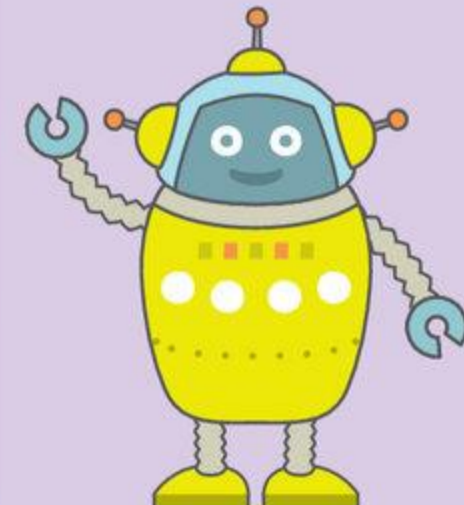

まちがいさがし

めやす 3 ぶん

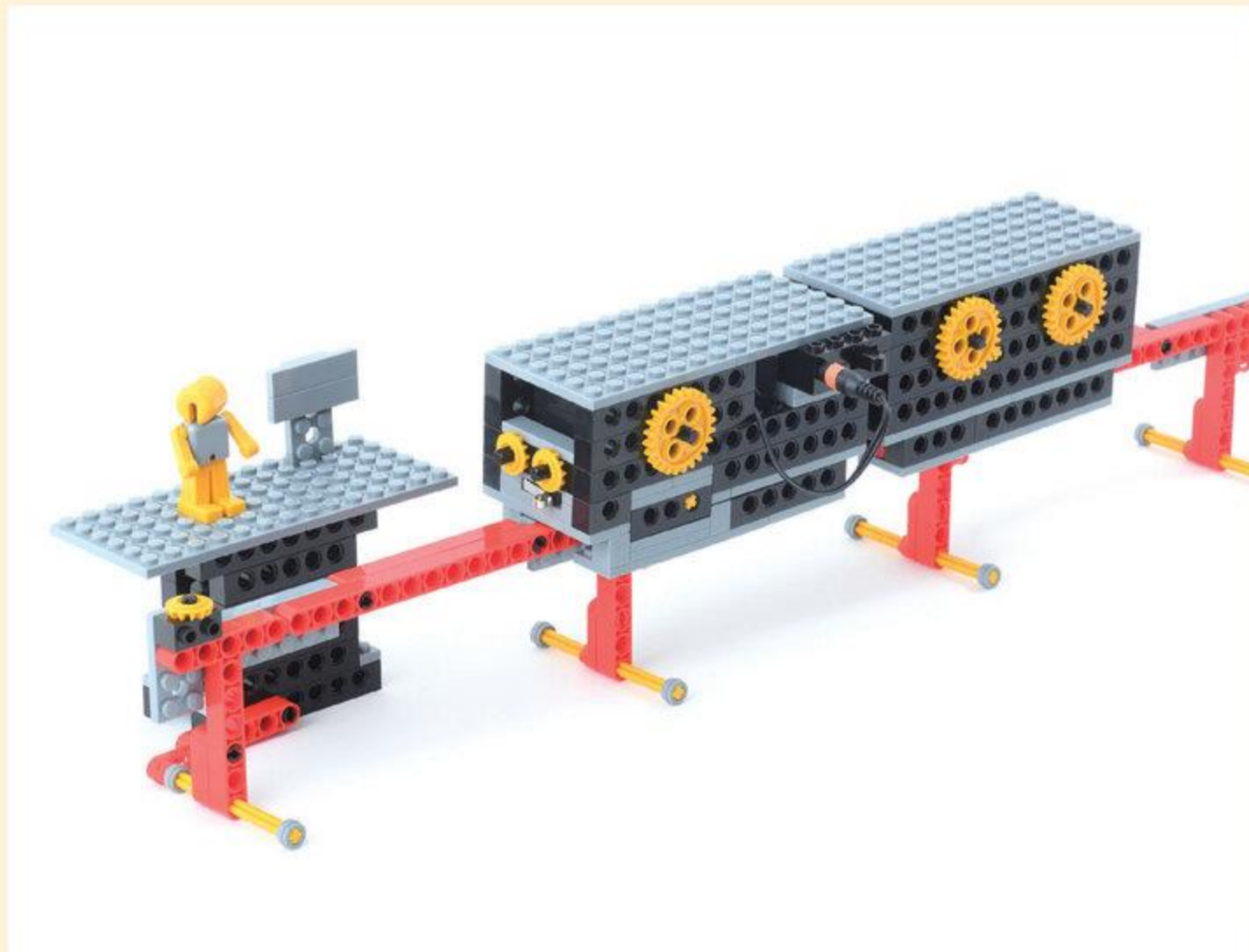

ちがうところを みつけよう
2つあるよ!

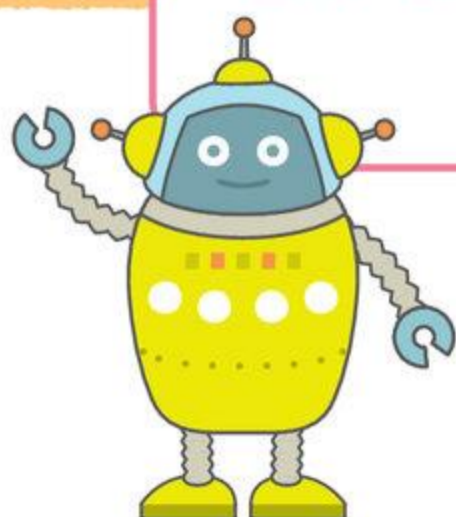

じかいの ロボット

じかいつくる^{るほつと}ロボットは
ぶらんこ^{るほ}ロボ
「ゆらりん」

じどうてきにぶらんこがゆれる
^{るほつと}
ロボットだよ

