



ヒューマンアカデミー ジュニア  
STEAMスクール



ロボット教室

# ロボットのきょうかしよ

プレプライマリーコース 回

1

ぶらんこロボ「ゆらりん」



★だい1かい

2023 ねん

11 がつ

にち

なまえ



## ちゅうい しょう

ばあっ パーツや でんきぶひんを あんぜんにつかうために

### ! ばあっ パーツを くちに いれない

くみたてた ばあっ パーツを とりはずすときは、  
ぜったいにはをつかってはいけません。  
ばあっ パーツを のみこんでは いけません。

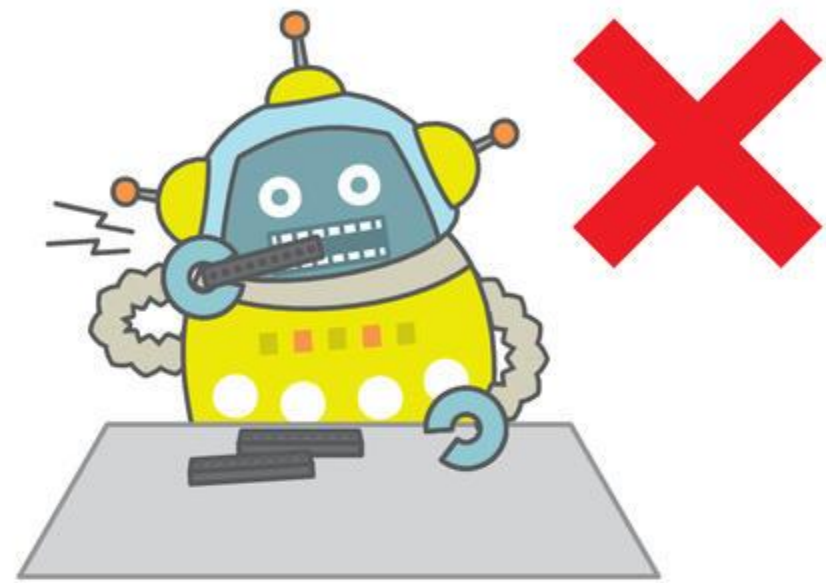

### ! ぶひんを きずつけない

でんきぶひんを はさみや かつたあ カッターなどで  
きずついたり、ばあっ パーツで はさんだりしては  
いけません (しゃしん 1)。

こおど や けえぶる コードや ケーブルは、おりまげたり、  
ひっぱったりしては いけません。

ぶらぐ の めきさしは、ぶらぐぶぶんを  
もって おこないましょう (しゃしん 2)。

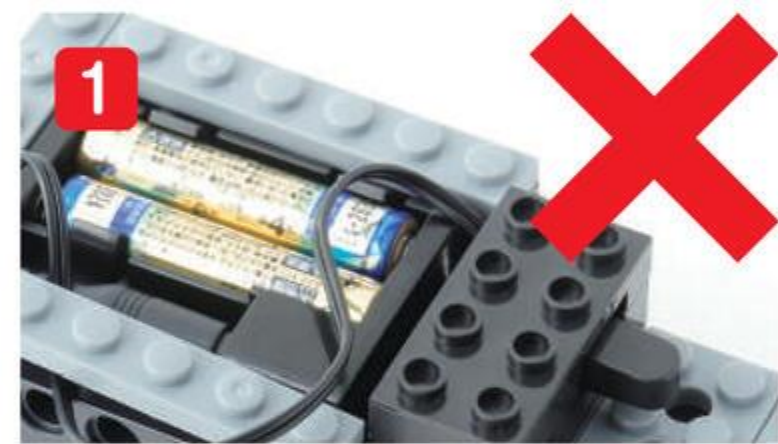

### ! あつい・におうとき、へんなおとが するとき

ろぼっと ロボットを うごかしたときに、でんちや でんきぶひんが  
あつくなったり、へんな においが したり、いつもと ちがうおとが  
したばあいは、すぐに ろぼっと ロボットを とめ、せんせいに しらせましょう。  
ぬれたてで でんきぶひんを さわっては いけません。



# もくじ

だい 1 かい		
ロボット <small>ろぼっと</small> のぶんかい	3	10ぶん
かんがえてみよう	3~4	12ぶん
きょう <small>ばあつ</small> のパーツ	5	
きょうのよてい	6	
くみたて		60ぶん
1. かべ	7~9	
2. じめん	10~20	
3. はしら	21~23	
4. ブランコ <small>ぶらんこ</small>	24~30	
5. もう1つの はしら	31~33	
ロボット <small>ろぼっと</small> を うごかそう	34~35	
クイズ <small>くいず</small>	36	3ぶん
かたづけ		5ぶん

ふるっく  
ブロックはずし



つかうと べんりだよ



10ポチ



このセットは くずさないでね! またつかうよ



## かんがえてみよう

めやす 5 ぶん



ブランコぶらんこに、のったことは あるかな?  
どんなふう に うごくかな?

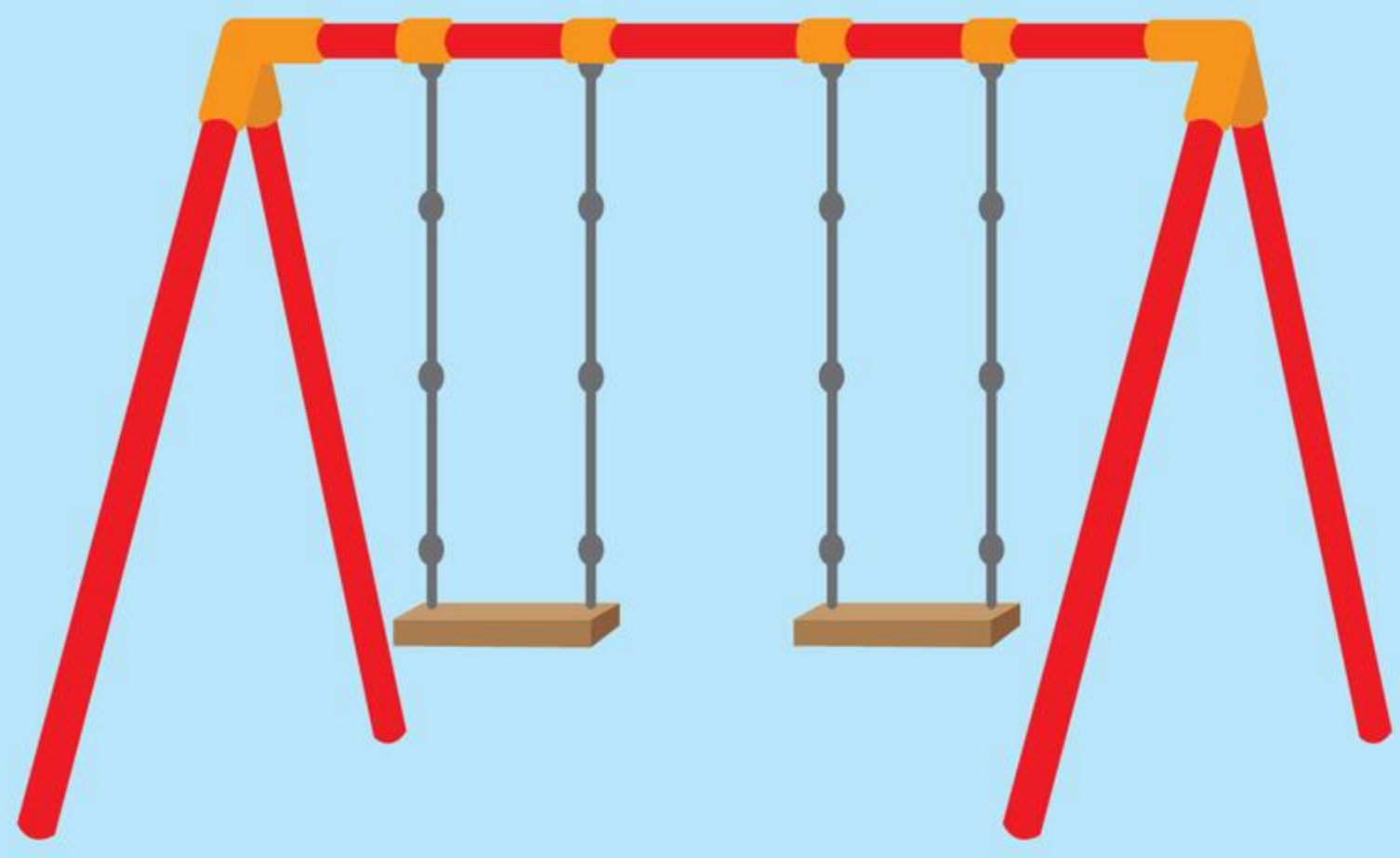





まえと うしろに、いったりきたりするよ!

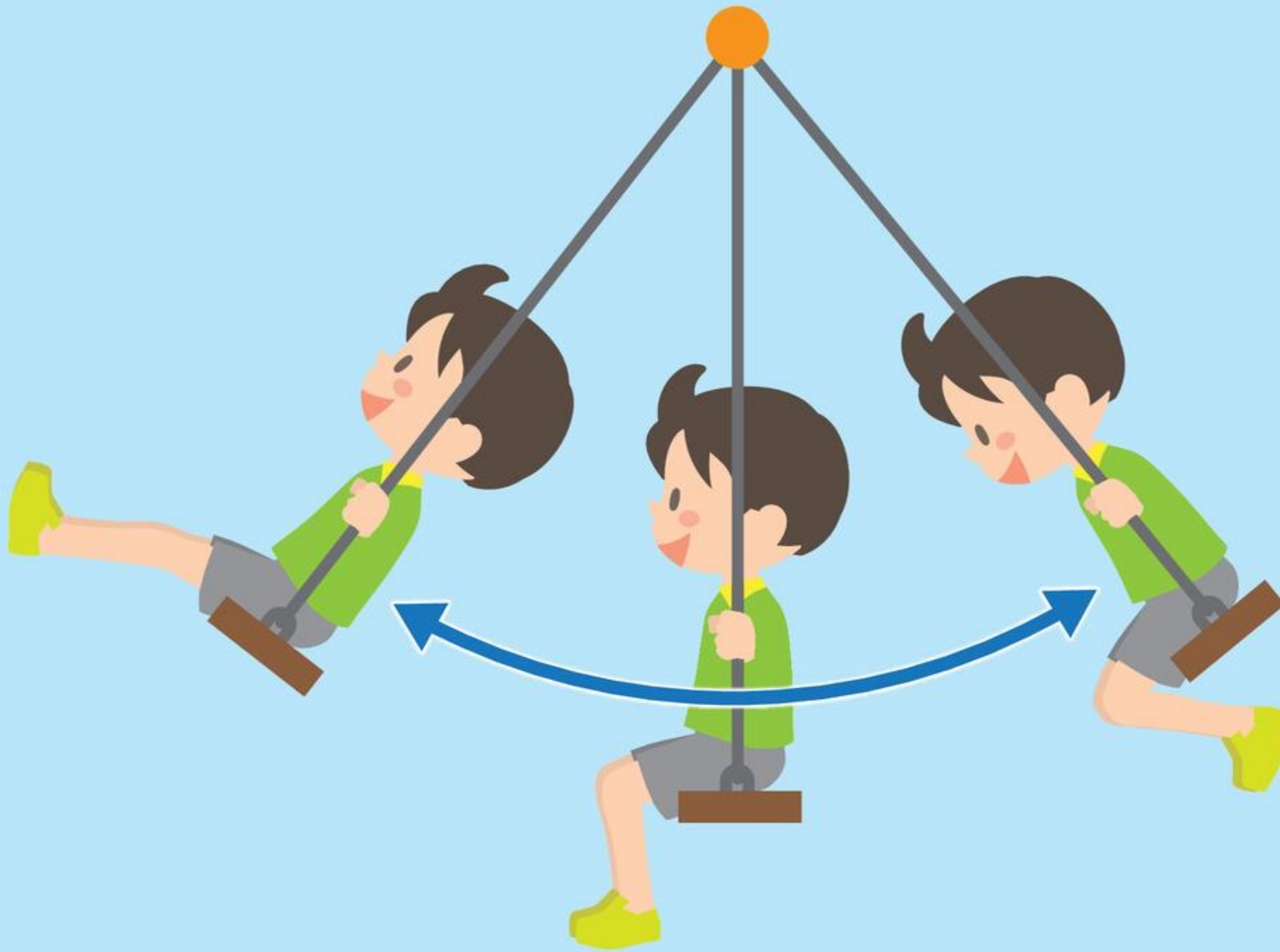

ぶらさがっている いすに すわって、  
まえに いったり、うしろに いったり、  
ゆらゆらうごくよ

だい 1 かいは <sup>て</sup>手で、  
だい 2 かいは <sup>も お た あ</sup>モーターで、ゆらゆら うごかすよ







めやす **5** ぶん

### ていじょいんと くろすじょいんと

# Tジョイント・クロスジョイント

## パーツをみつけよう



### とくちょう

いろいろなかたちの  
アナがあるね!

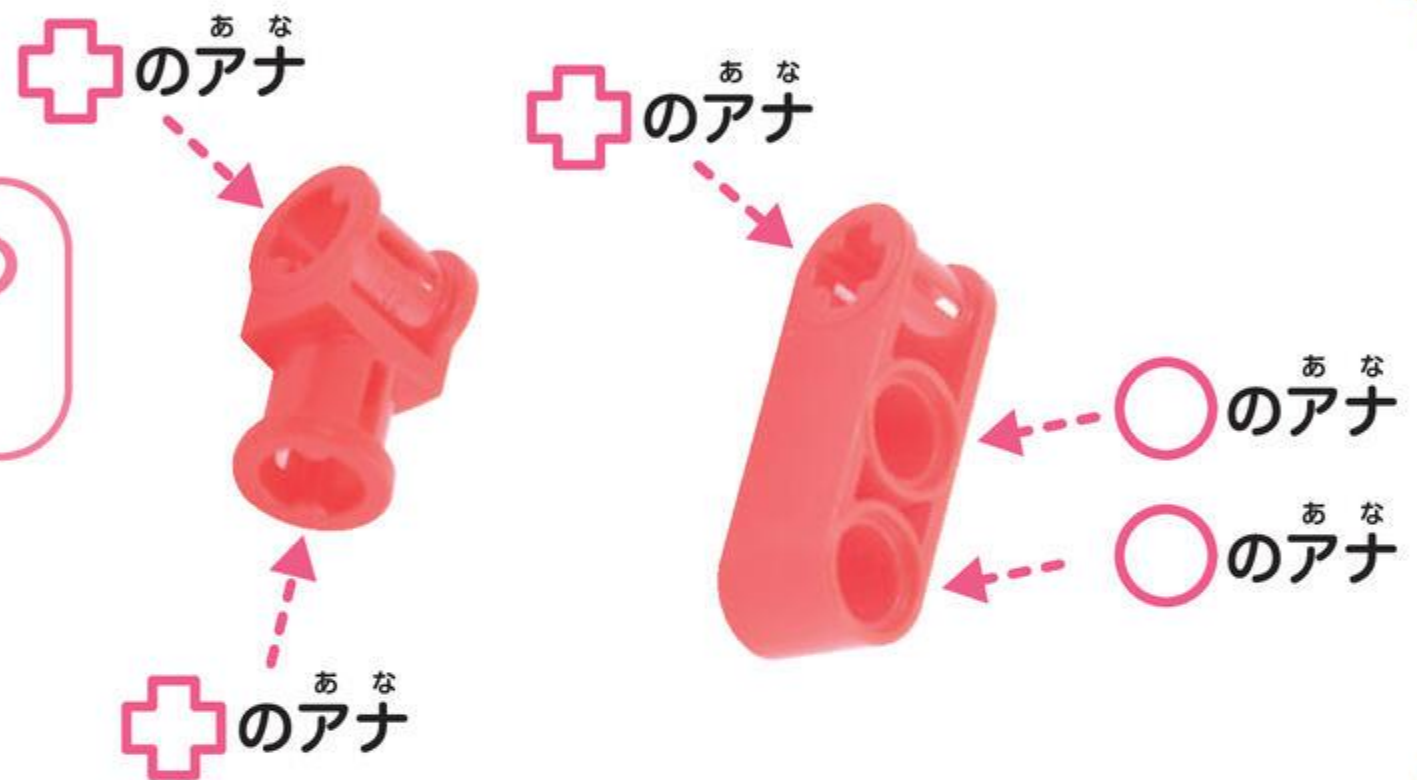
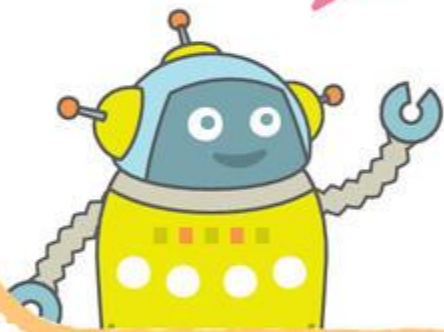

### まずたあ

## マスターしよう

いろいろな ばあつ パーツがとりつけられるよ





# きょうの よてい

めやす 2 ふん

このじゅんばんでつくるよ!

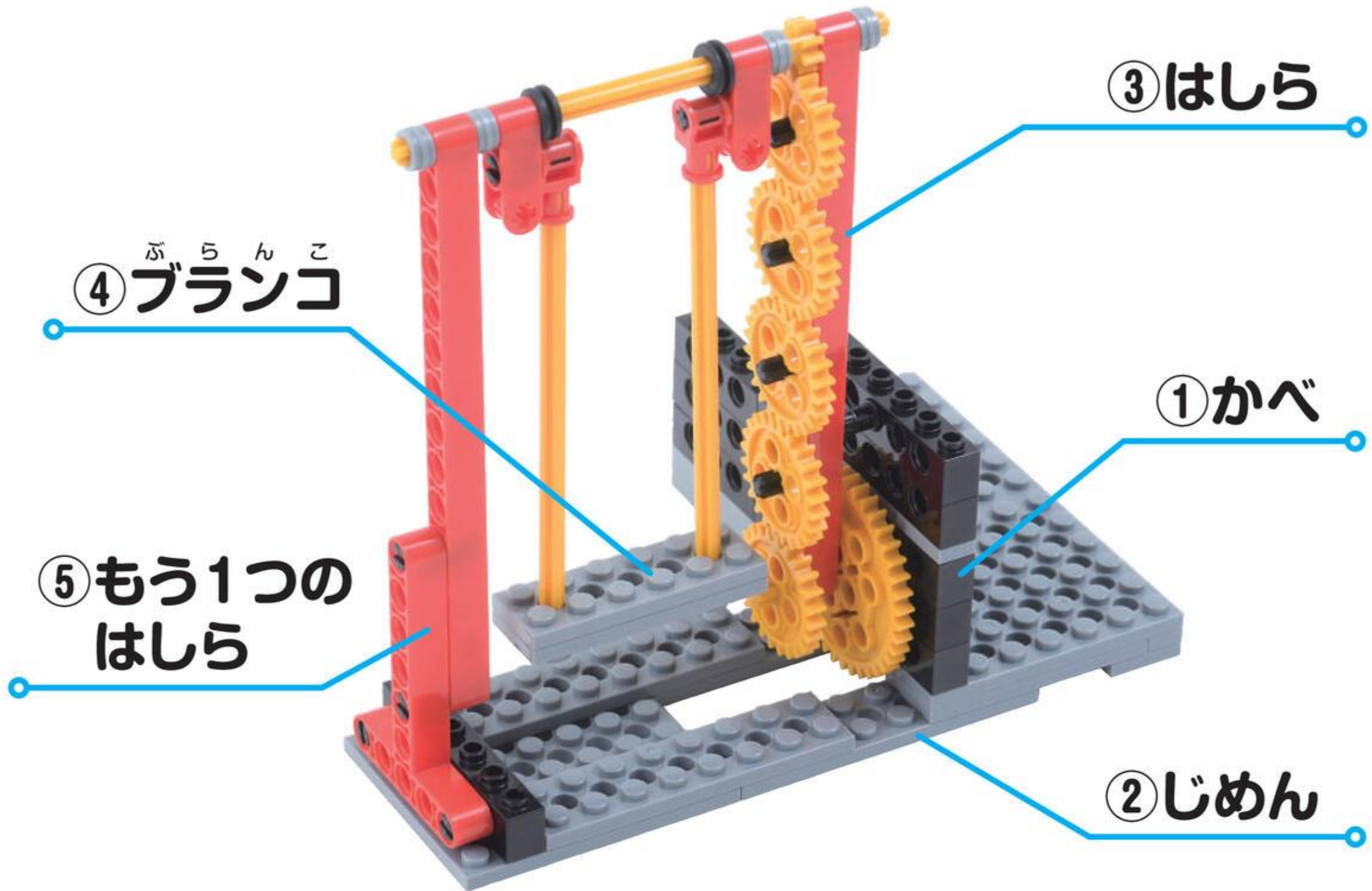

①かべ

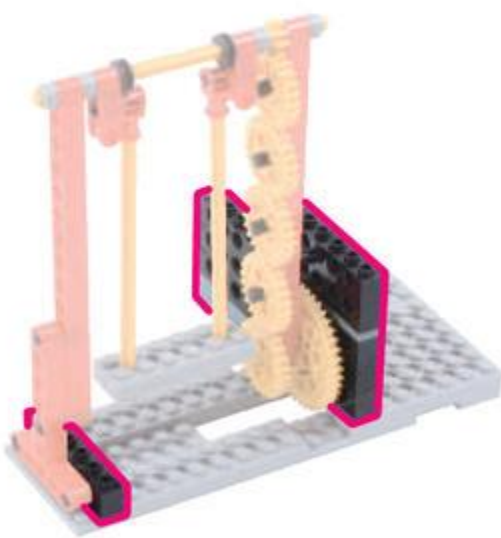

②じめん

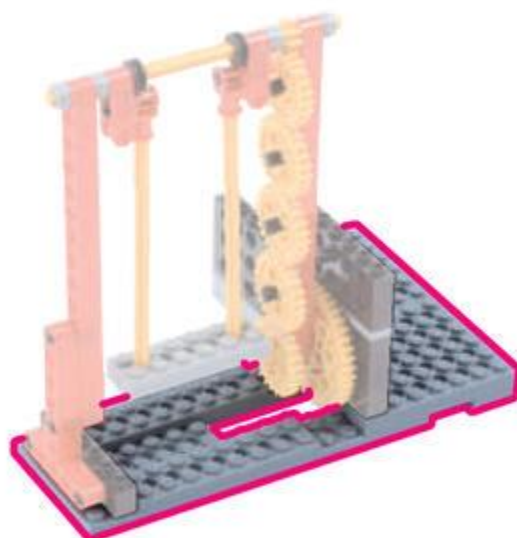

③はしら

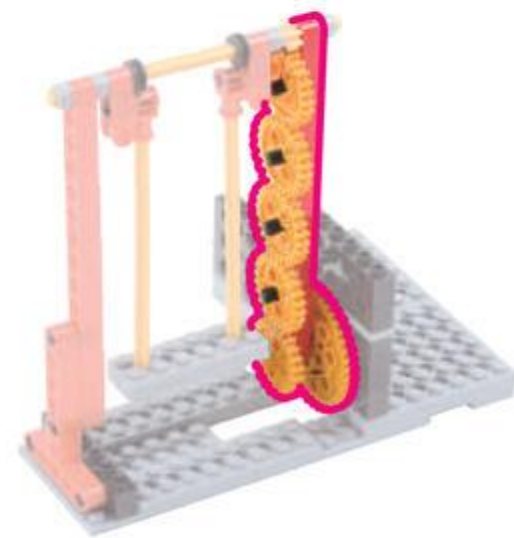

④ブランコ

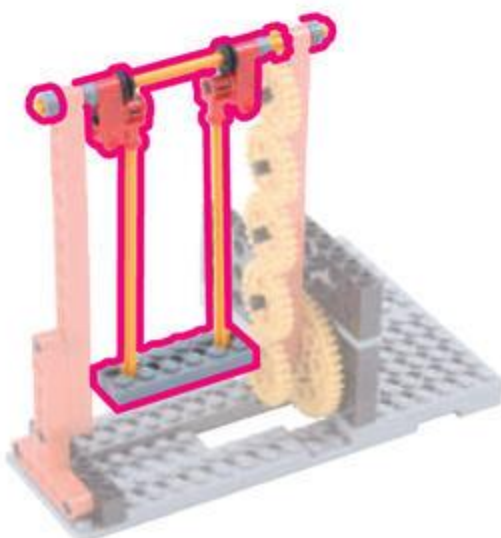

⑤もう1つのはしら

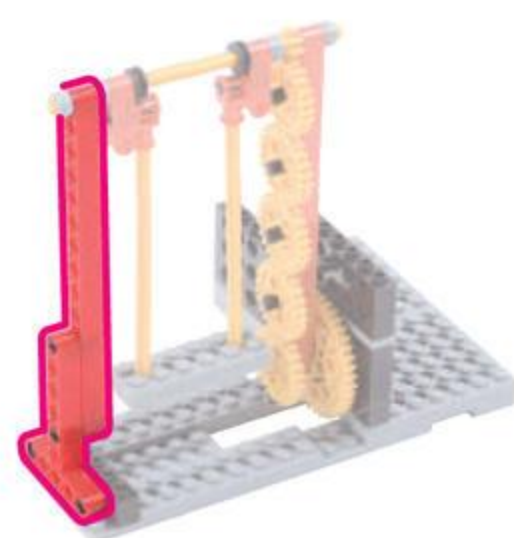



1 かべ めやす 5 ふん

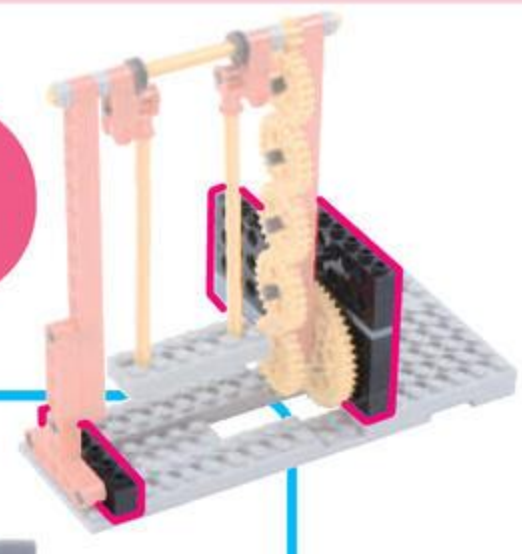

びいむろくほち  
ビーム 6 ポチ 2こ



ほそぶれえとろくほち  
細プレート 6 ポチ 1こ



1





びいむはちほち  
ビーム 8 ポチ 3こ



びいむよんほち  
ビーム 4 ポチ 3こ

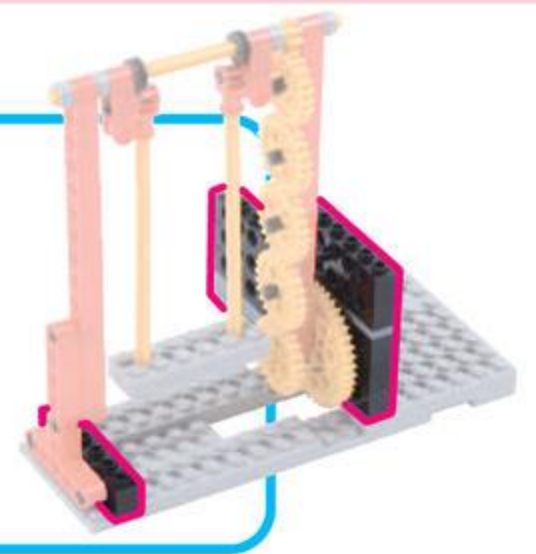

2

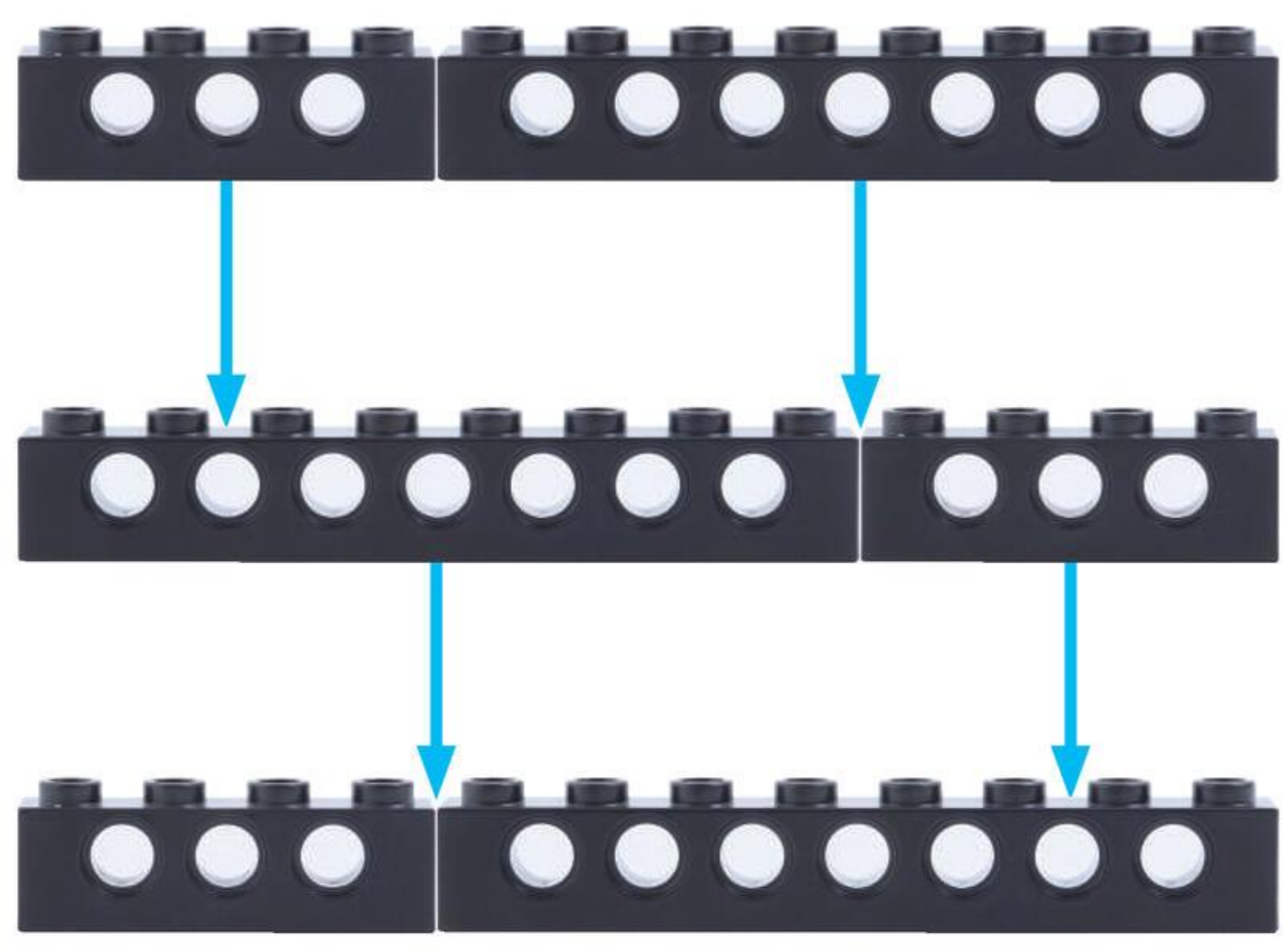



3

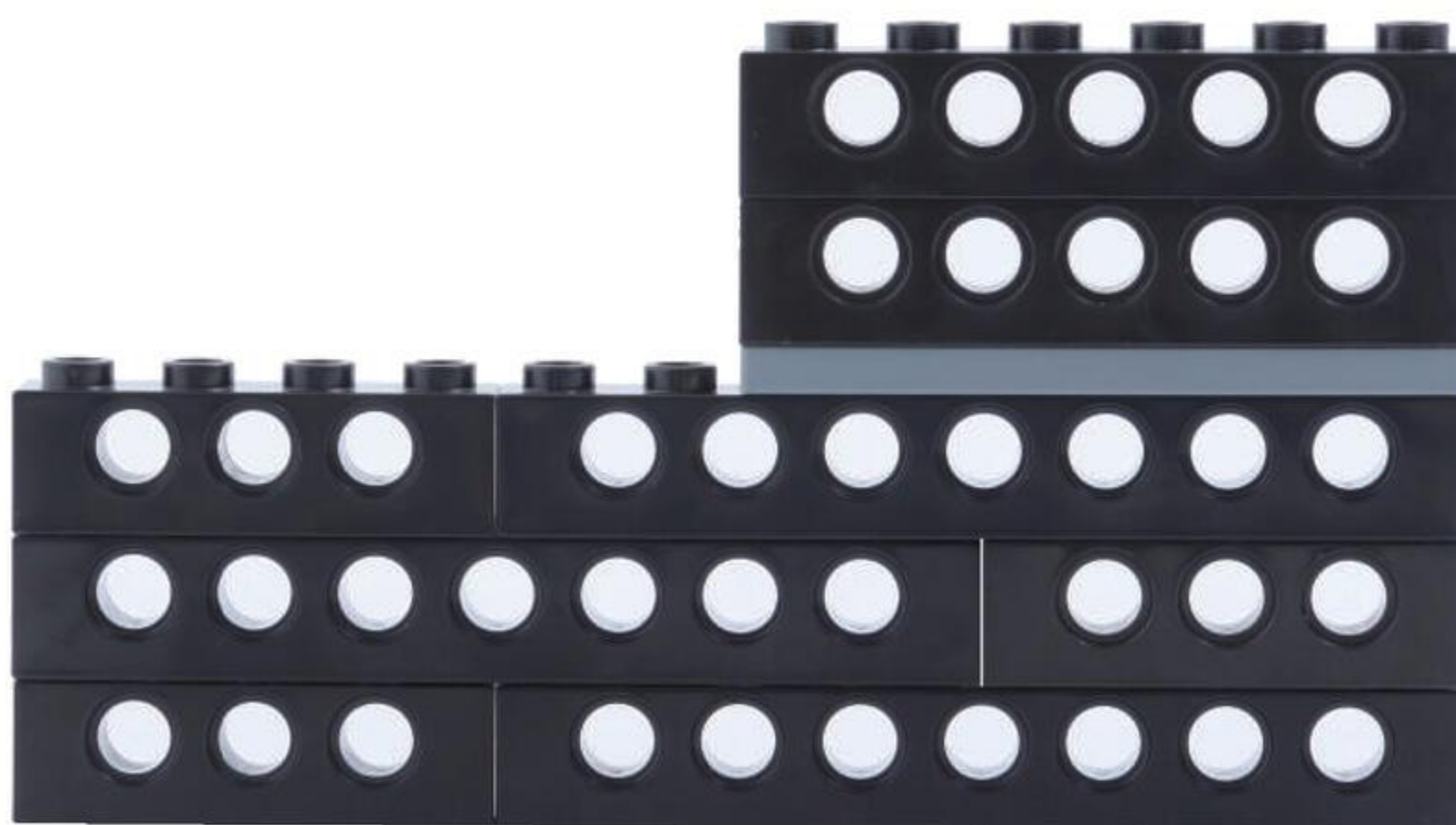
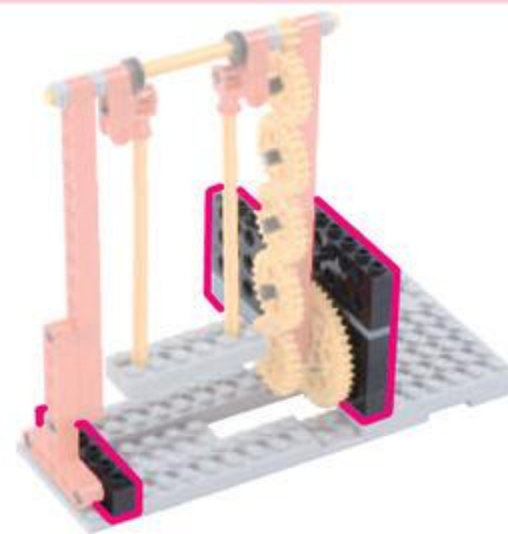

かべが  
かんせい!

やったね!

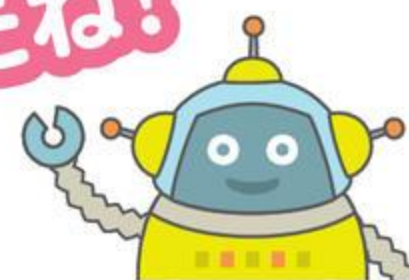



2 じめん

めやす 15 ぶん

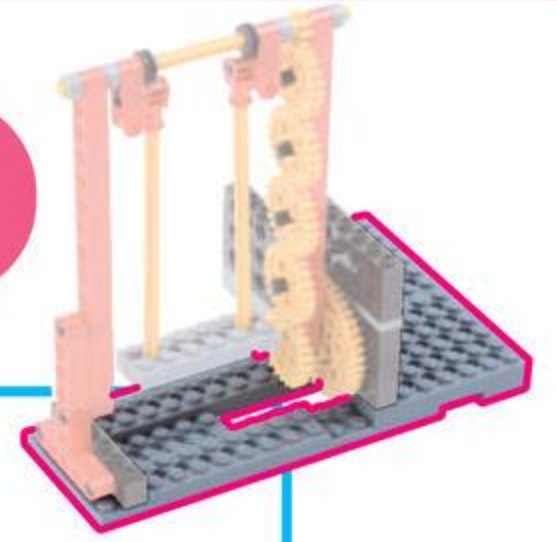

ふれえとろ  
プレートL 1こ

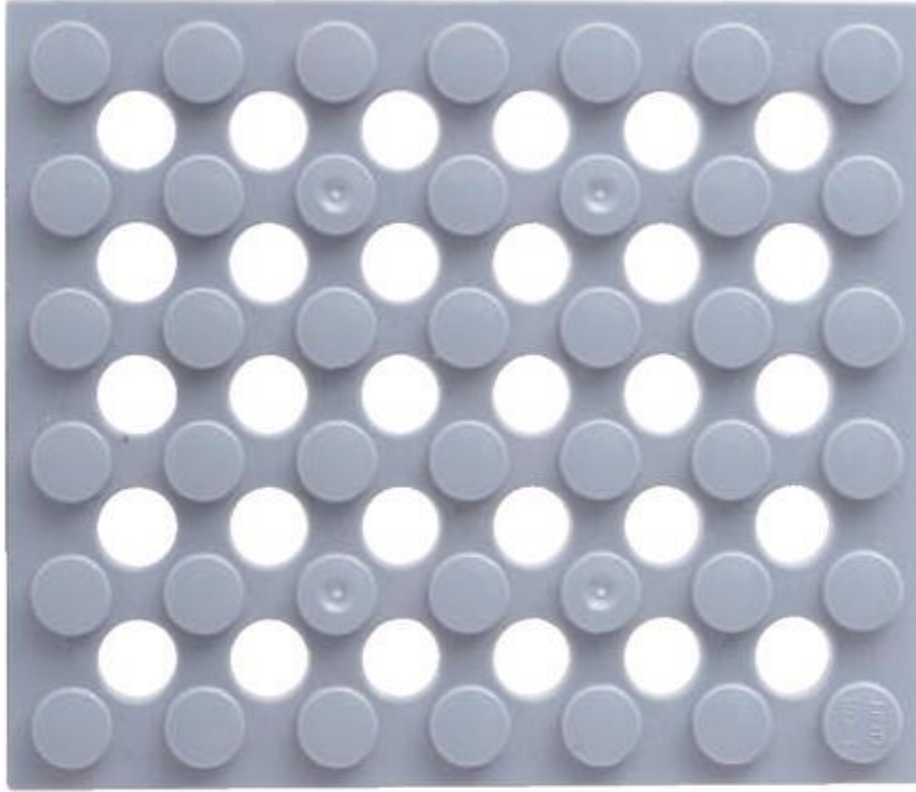

ふとふれえとはちほち  
太プレート8ポチ 4こ



1

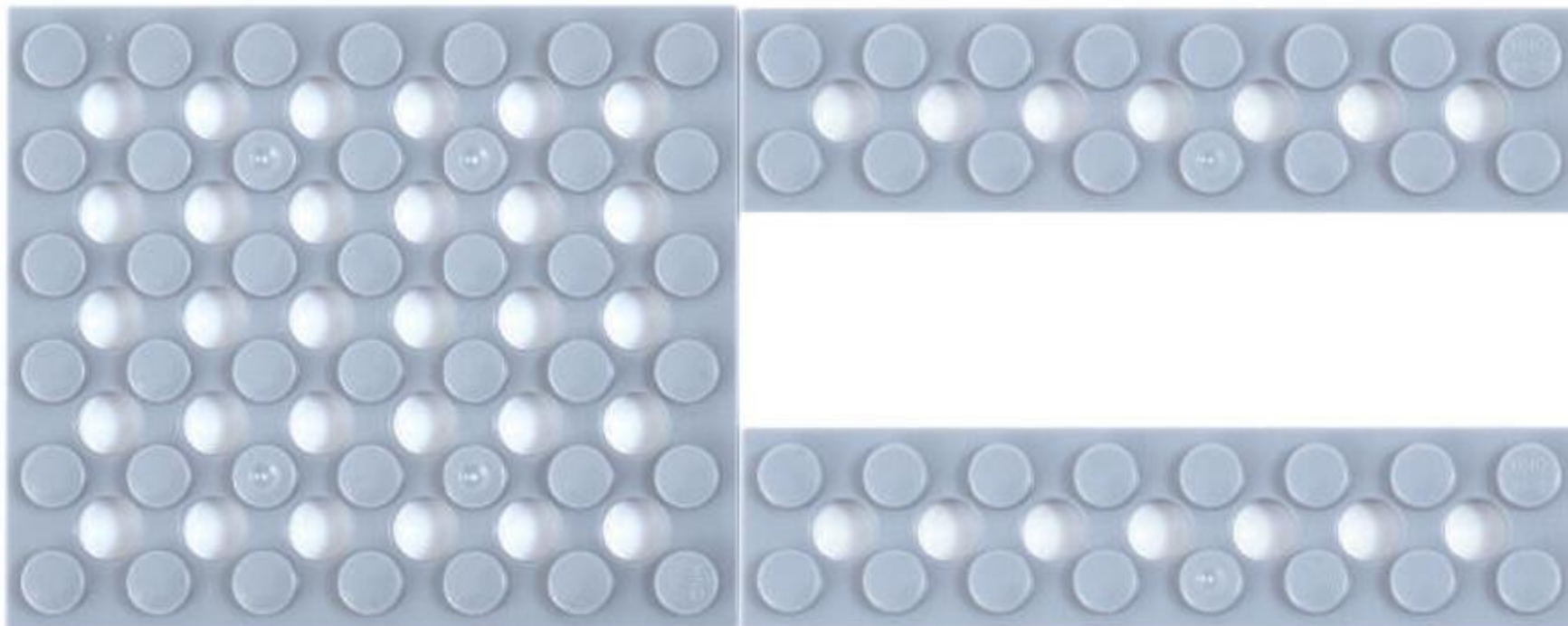



2

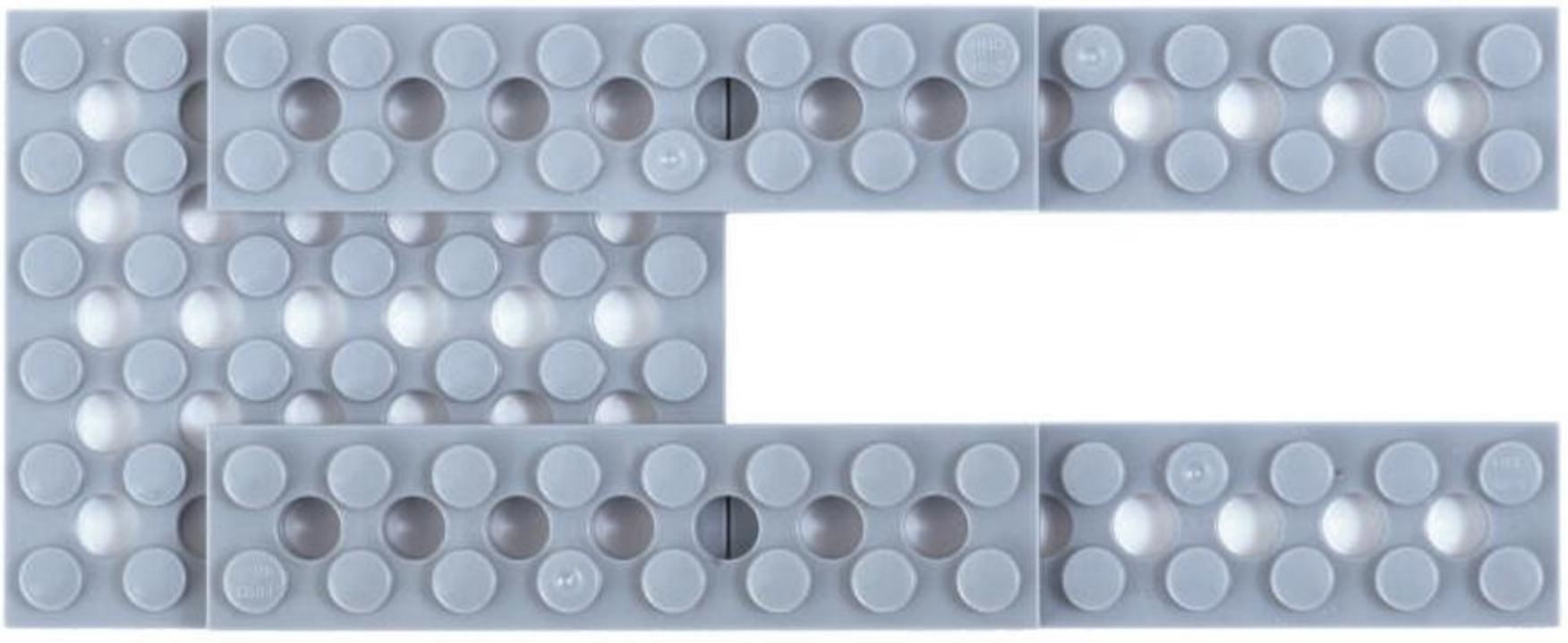
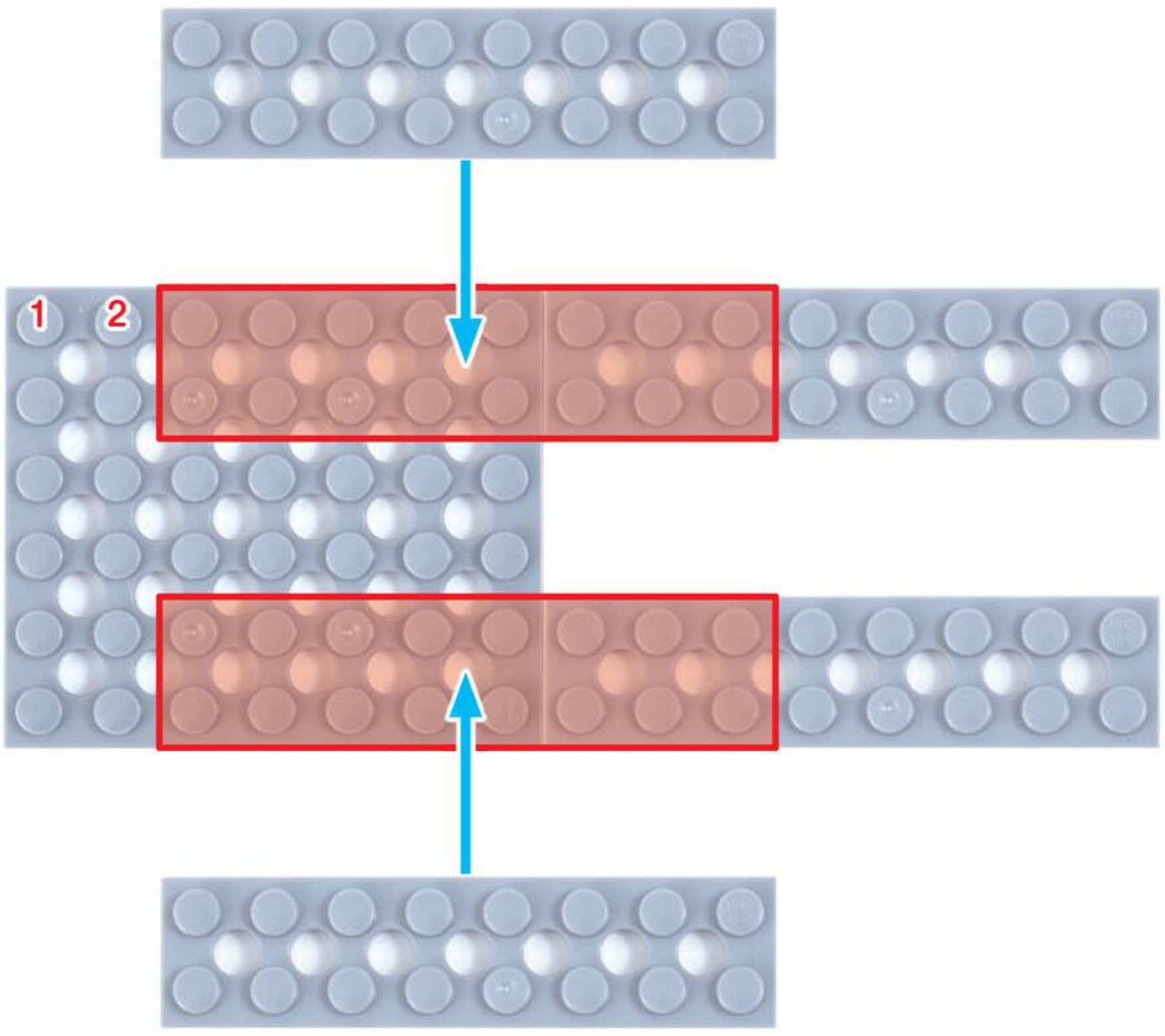
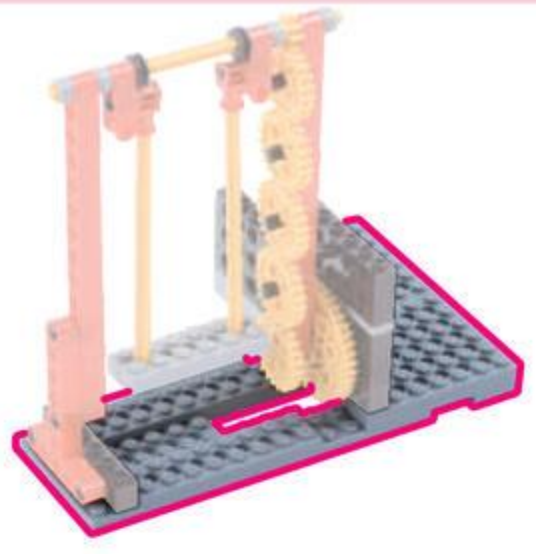



ふとぶれえとろくほち  
太プレート 6 ポチ 1こ



ふとぶれえとはちほち  
太プレート 8 ポチ 1こ

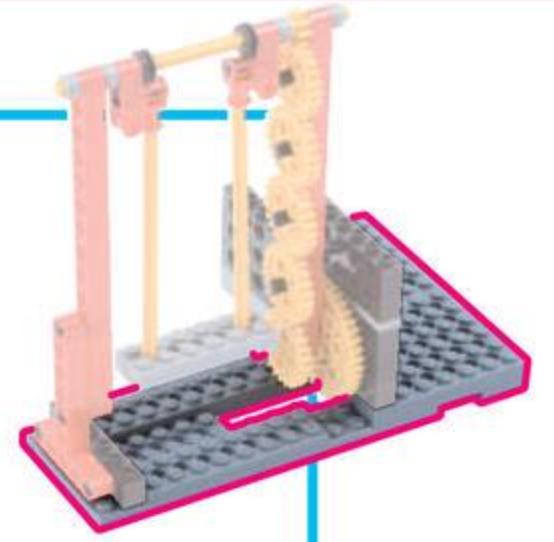

3

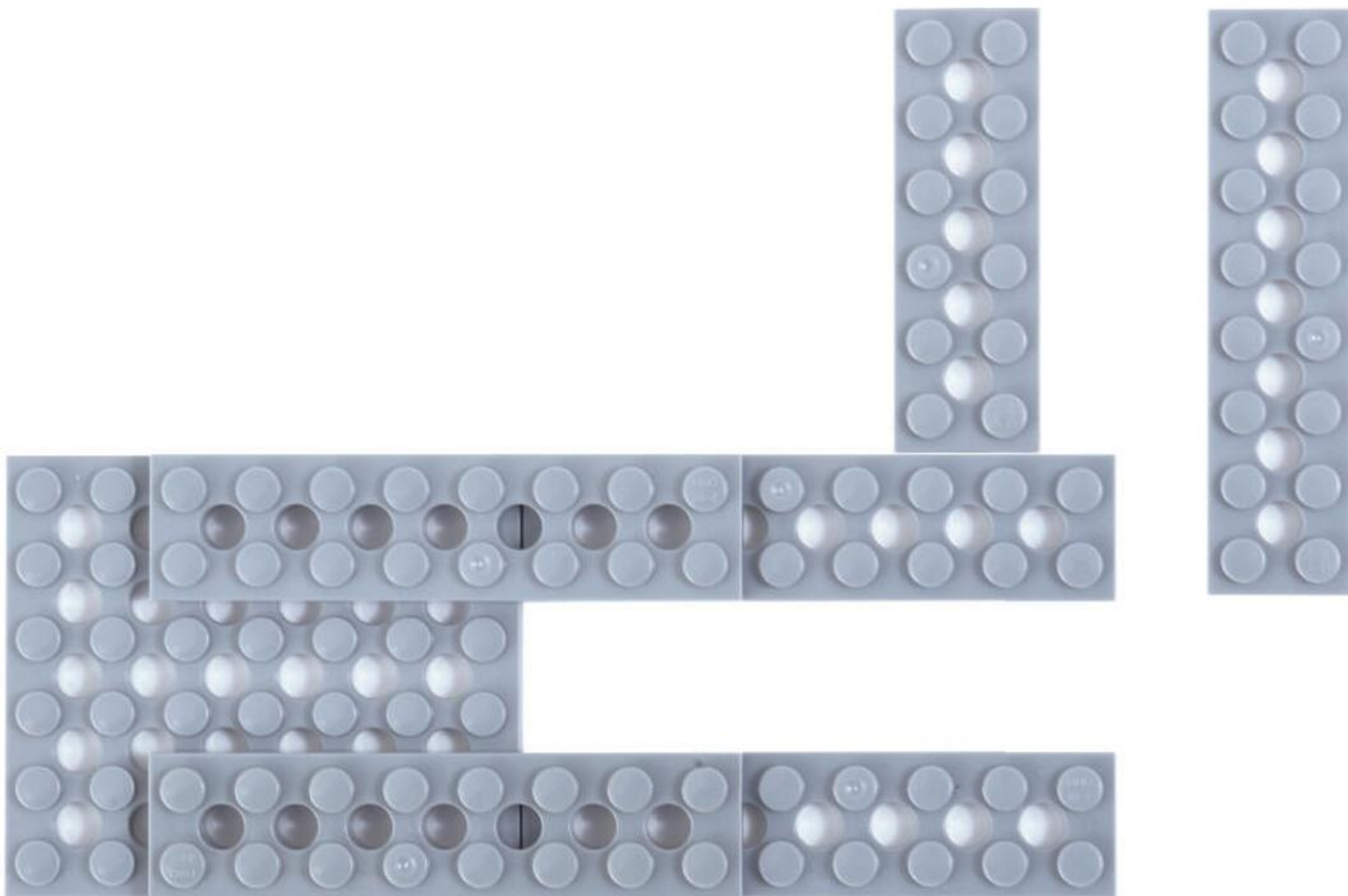



4

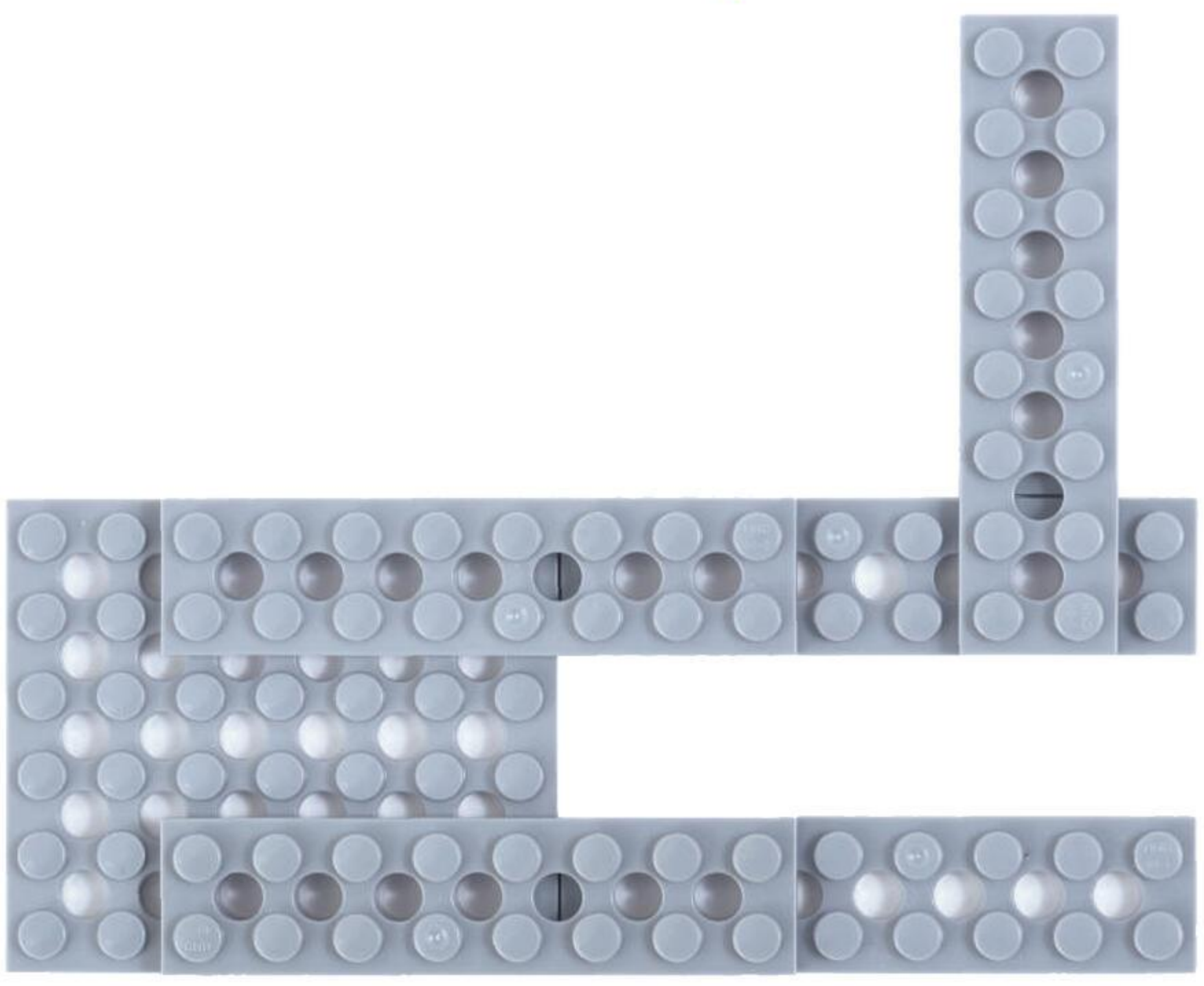
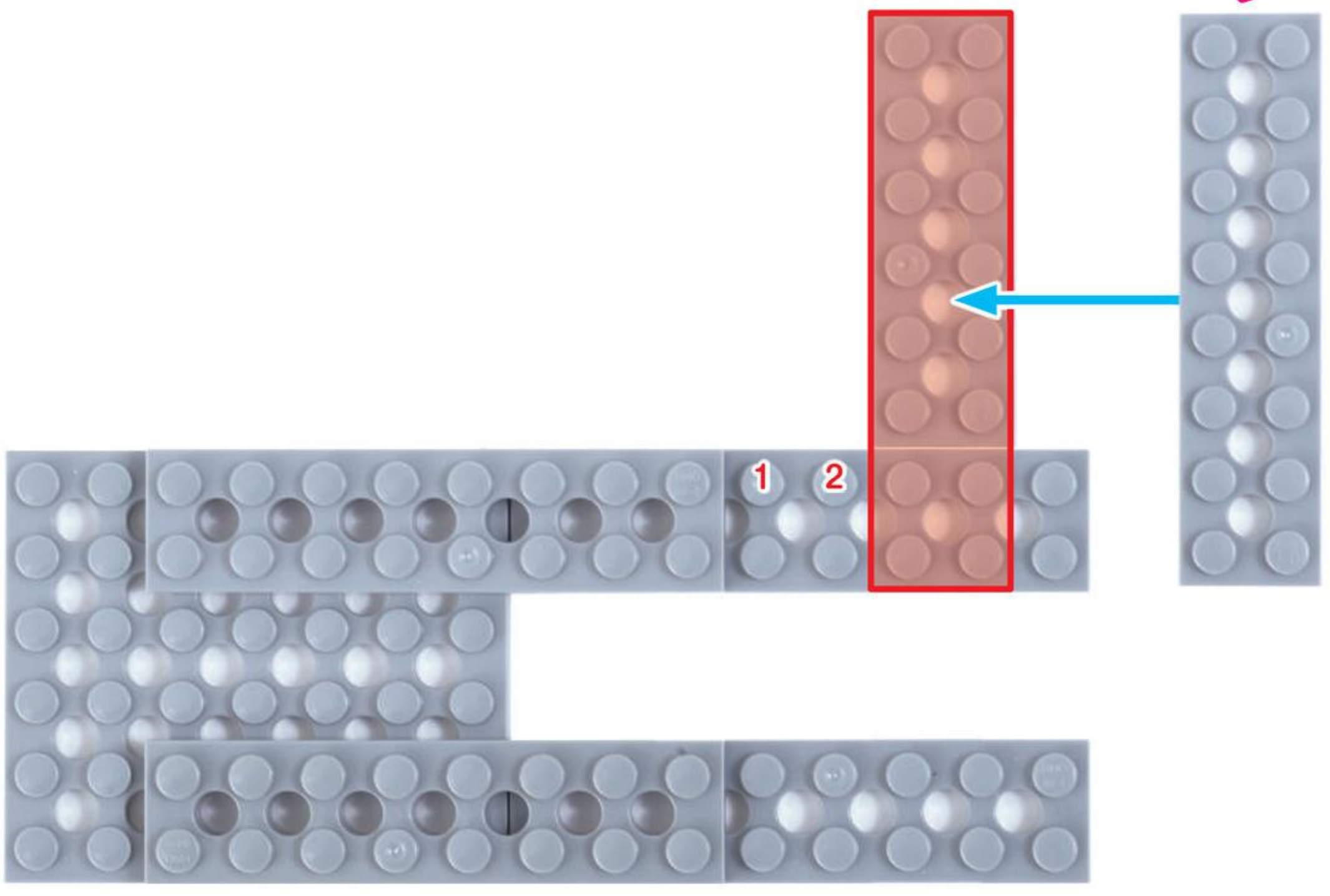



ふとぶれえとよんぼち  
太プレート 4 ポチ 1こ



ふとぶれえとはちぼち  
太プレート 8 ポチ 1こ

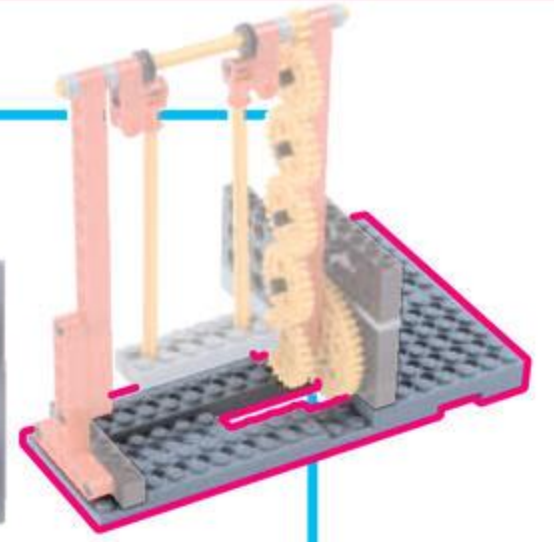

ふとぶれえとろくぼち  
太プレート 6 ポチ 1こ



ほそぶれえとろくぼち  
細プレート 6 ポチ 1こ



5





6

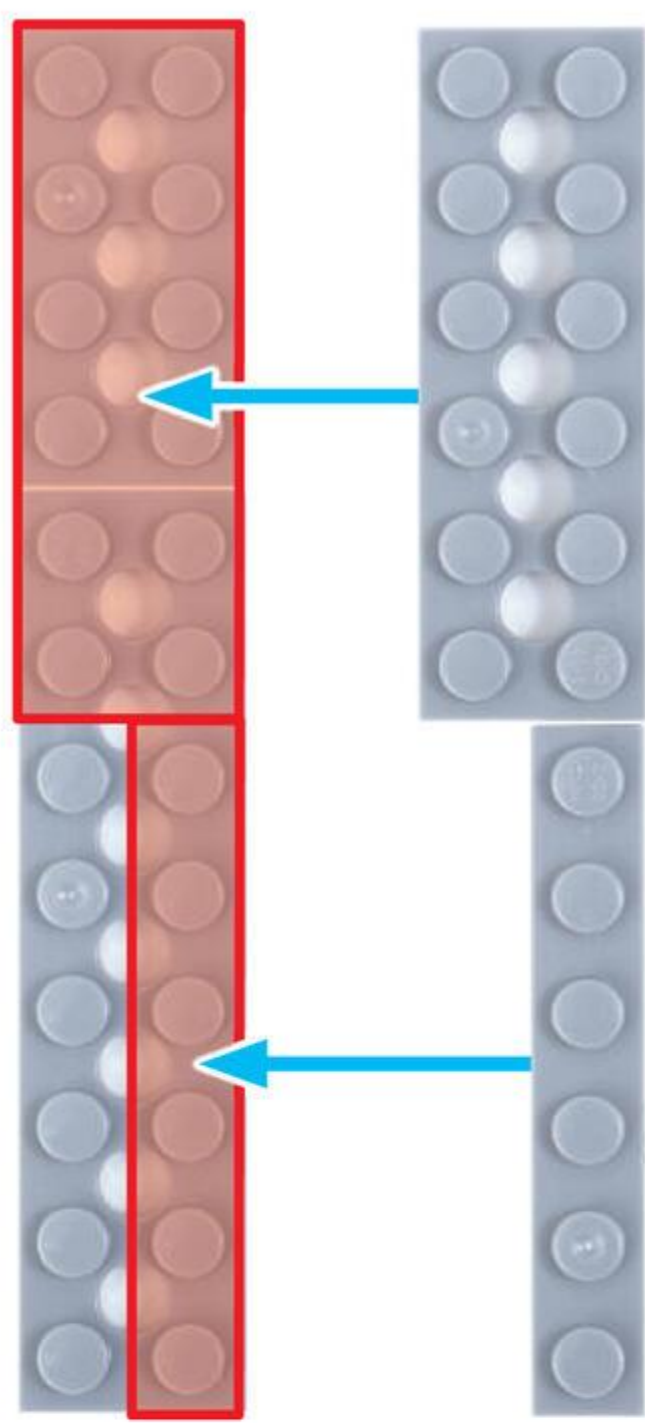



ふとぶれえとろくぼち  
太プレート 6 ポチ 1こ



ふとぶれえとよんぼち  
太プレート 4 ポチ 1こ

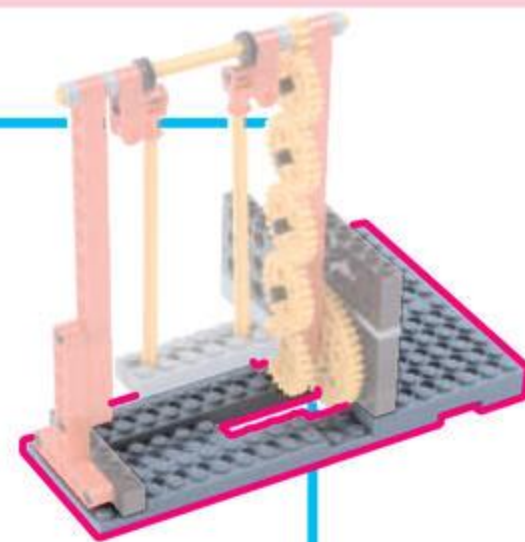

7

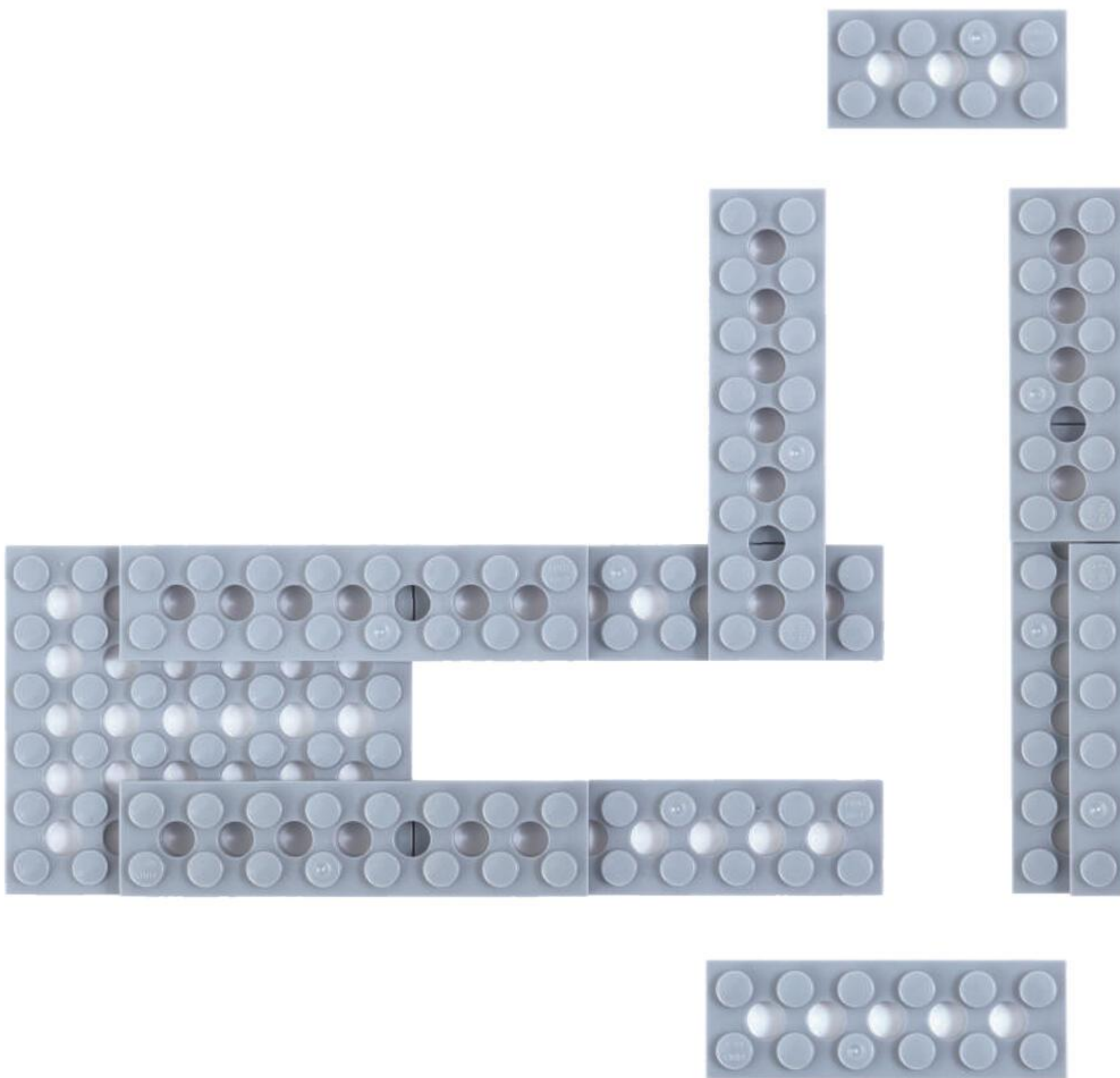



8

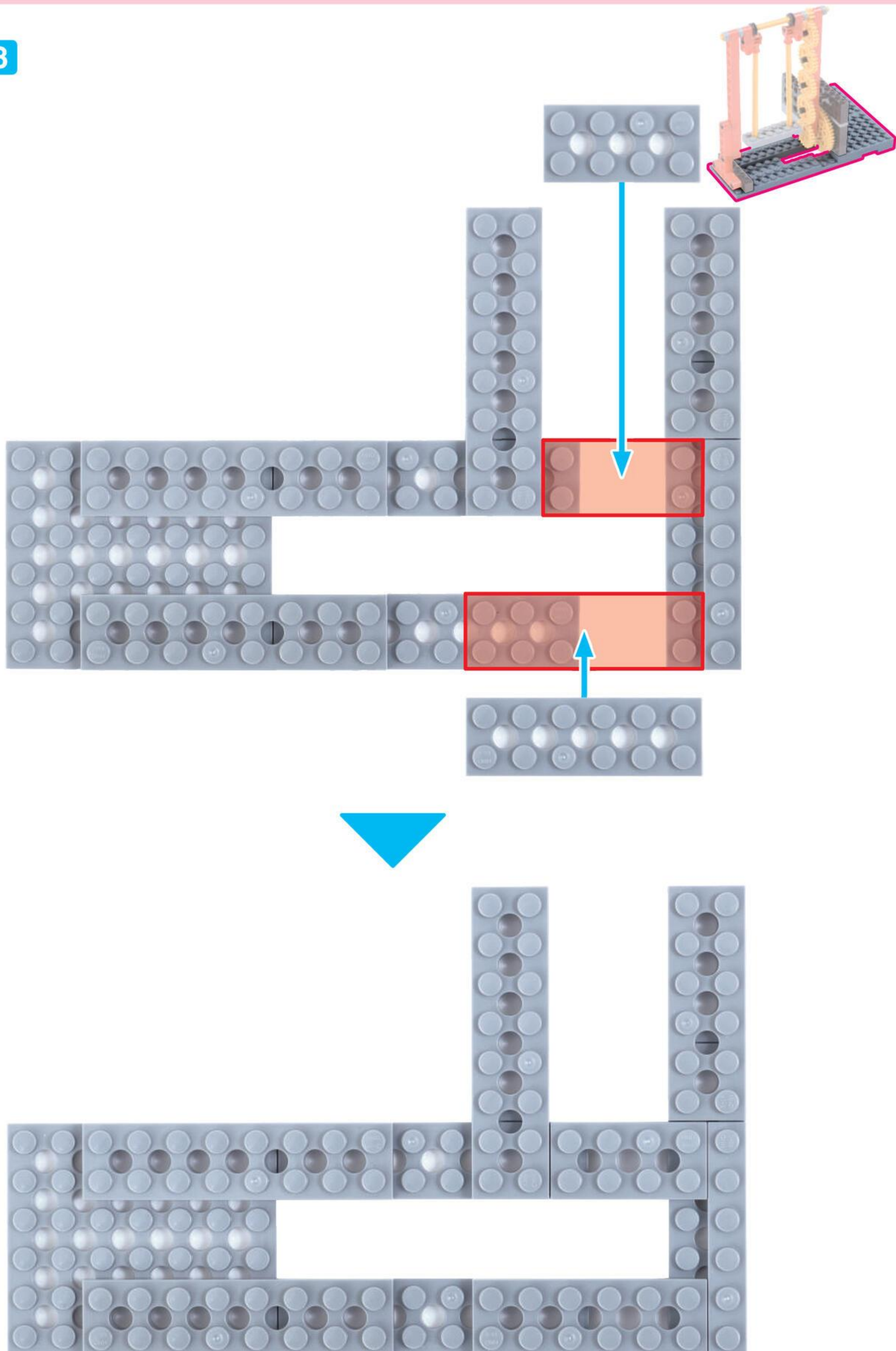



ぶれえとる  
プレートL 2こ

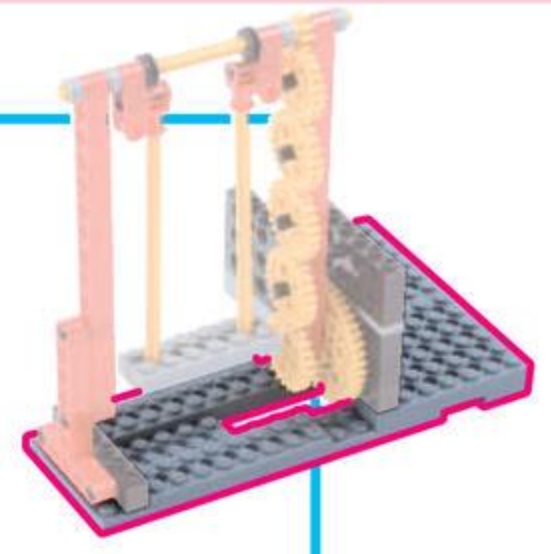
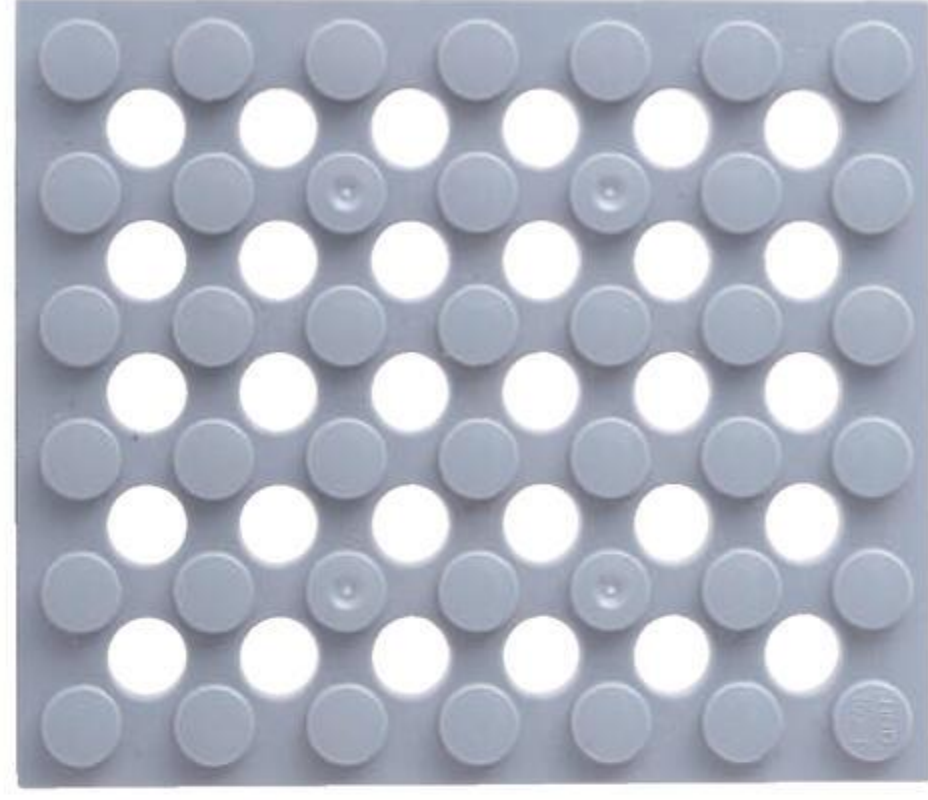

9

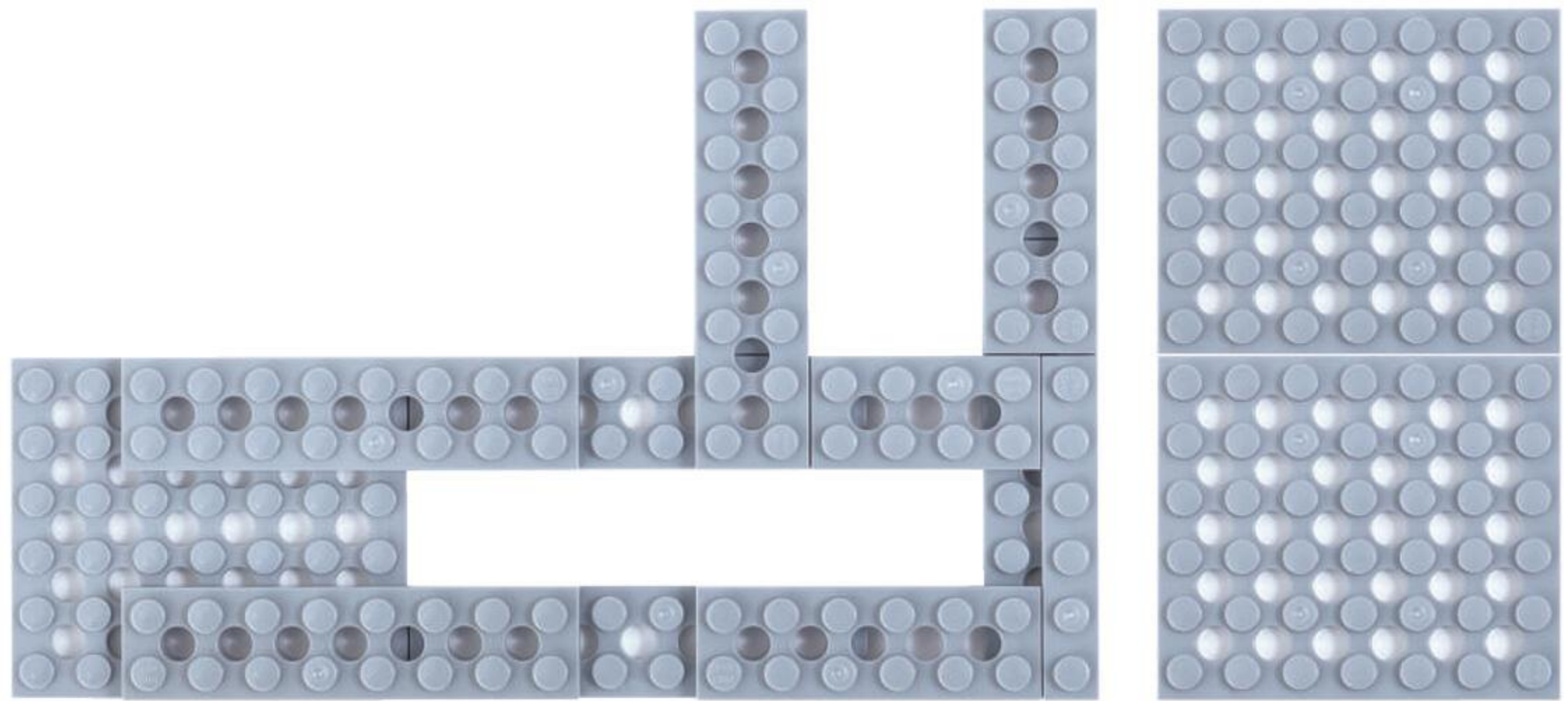



10

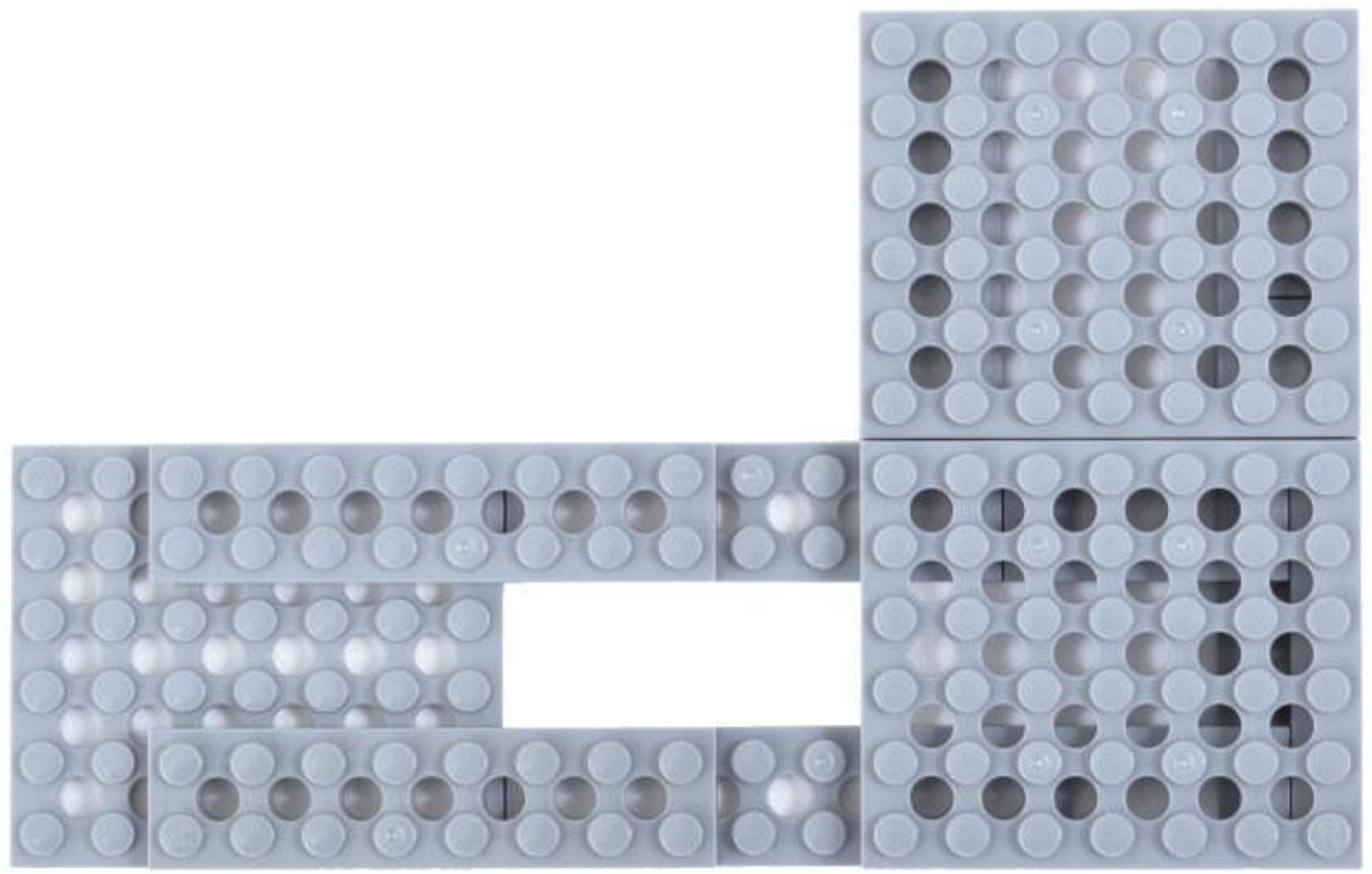
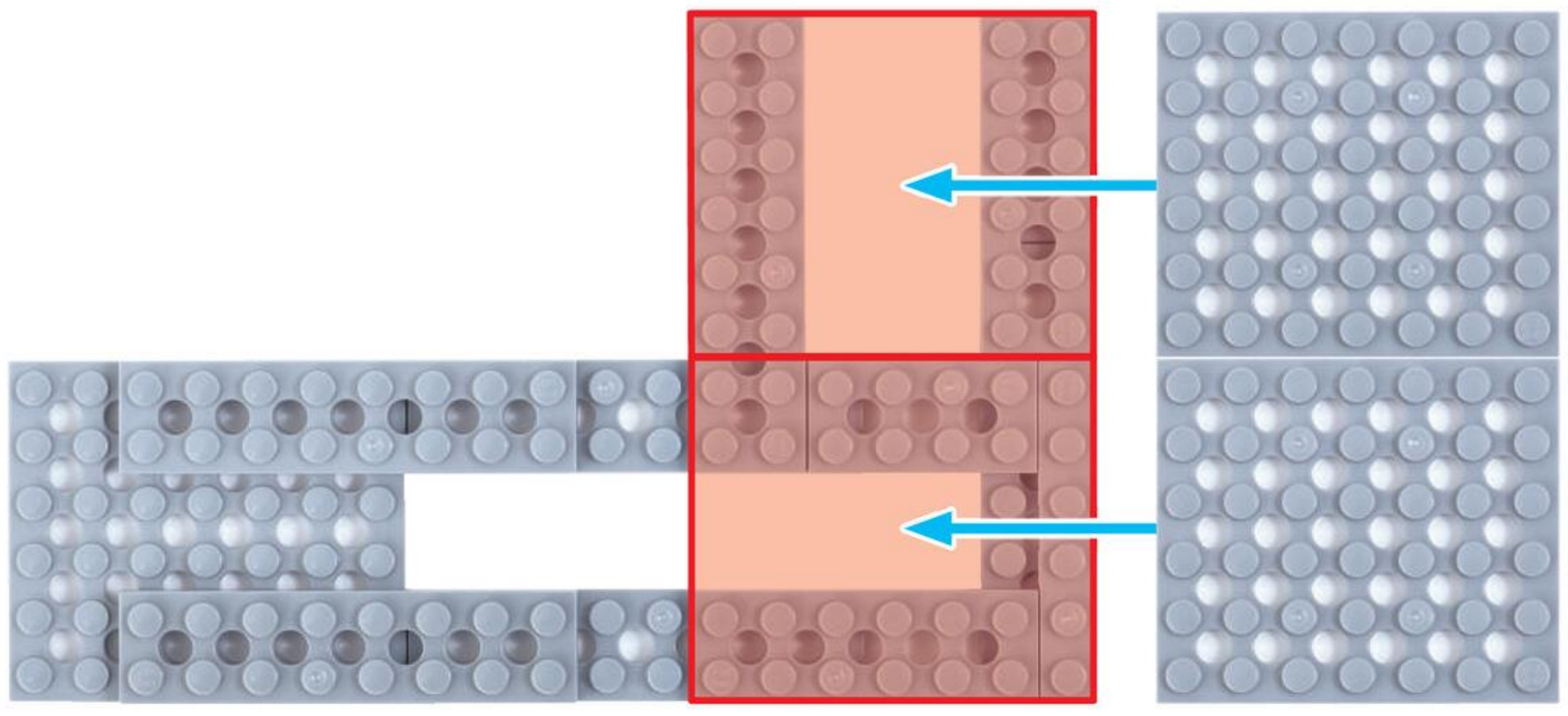



びいむろくほち  
ビーム6ポチ 1こ

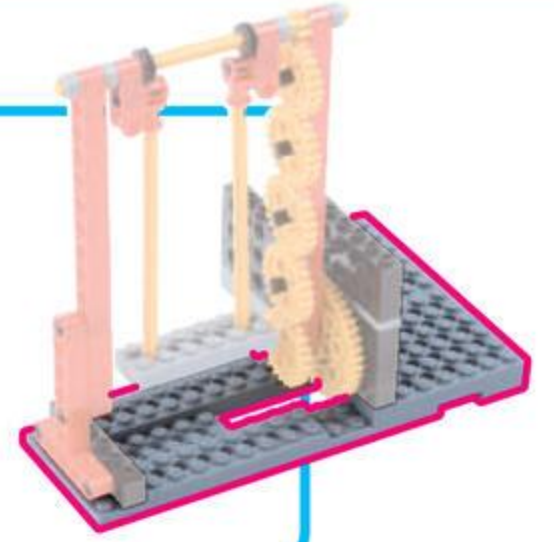

11

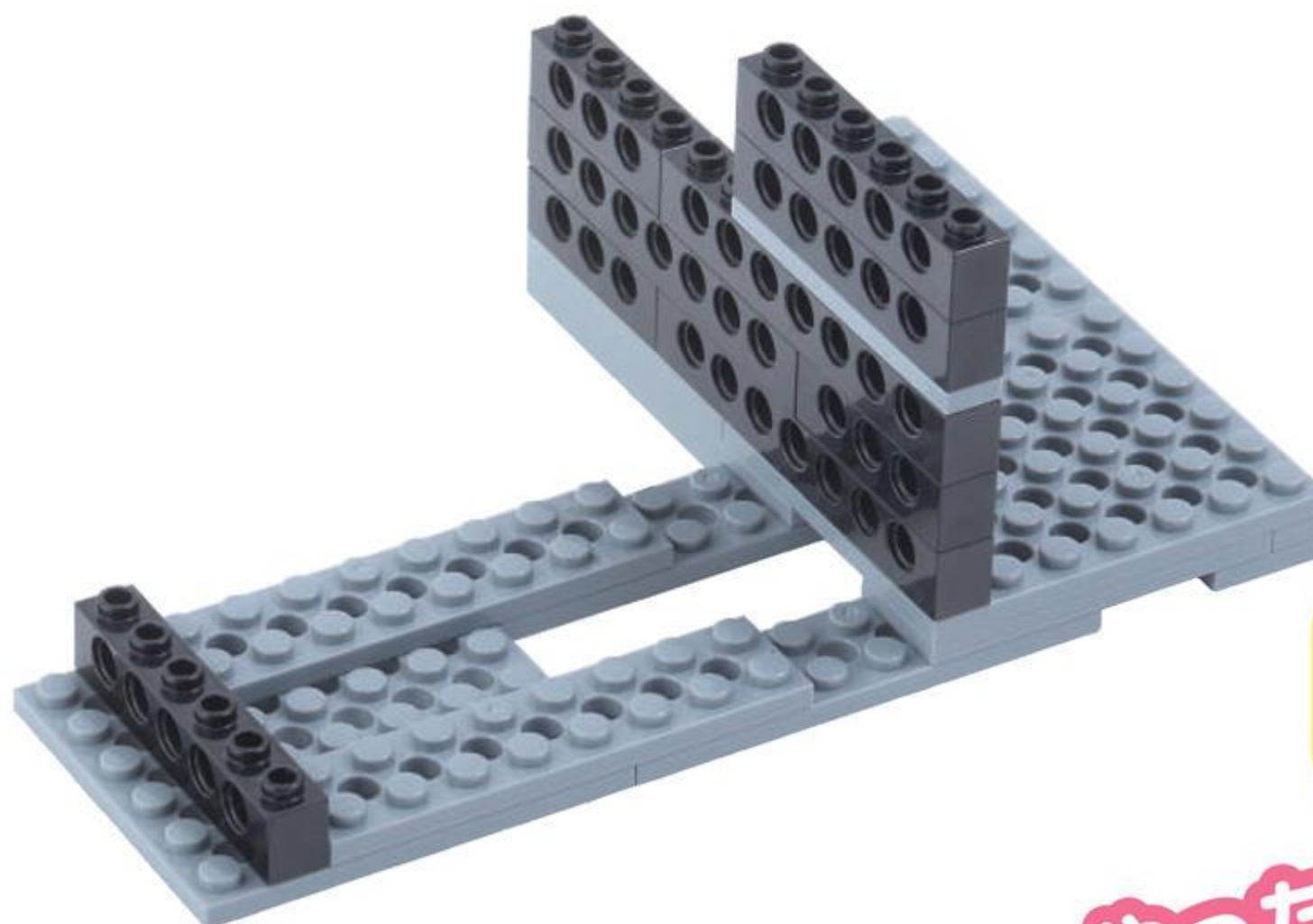
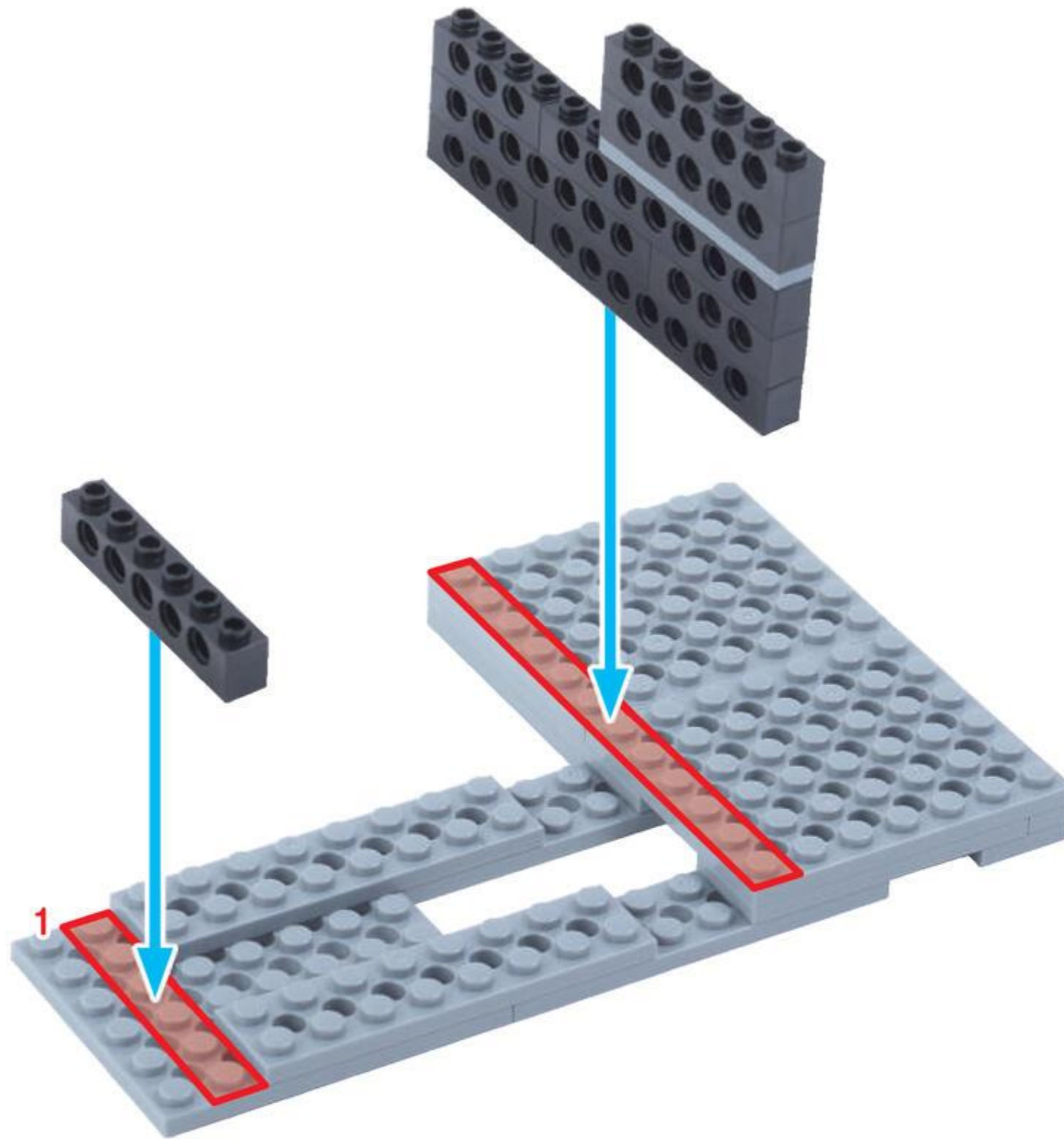

じめんが  
かんせい!

やったね!

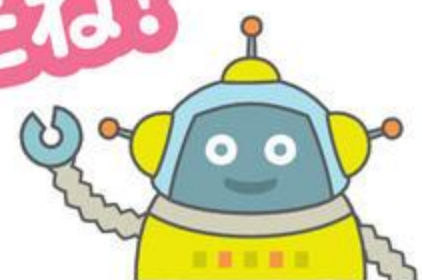



# 3 はしら めやす 10 ぶん

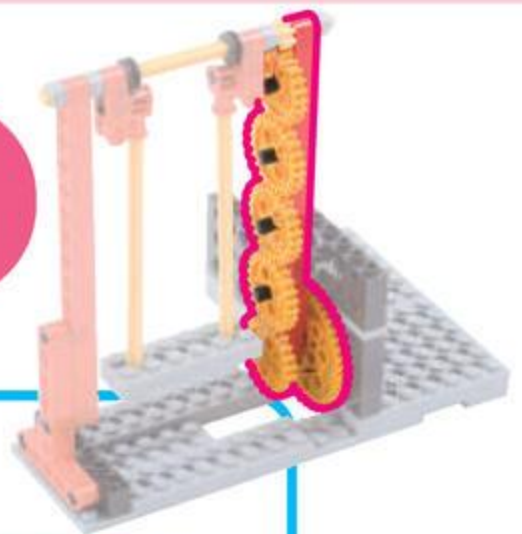

ろっど <sup>しゅうご</sup> <sup>あな</sup> 15 アナ 1 こ

しゃふと <sup>ご</sup> <sup>ぼち</sup> シャフト 5 ポチ 1 こ

ながさに ちゅうい

しゃふと <sup>ぺぐ</sup> シャフト <sup>ぺぐ</sup> 4 こ

ぺぐ <sup>える</sup> 1 こ

1

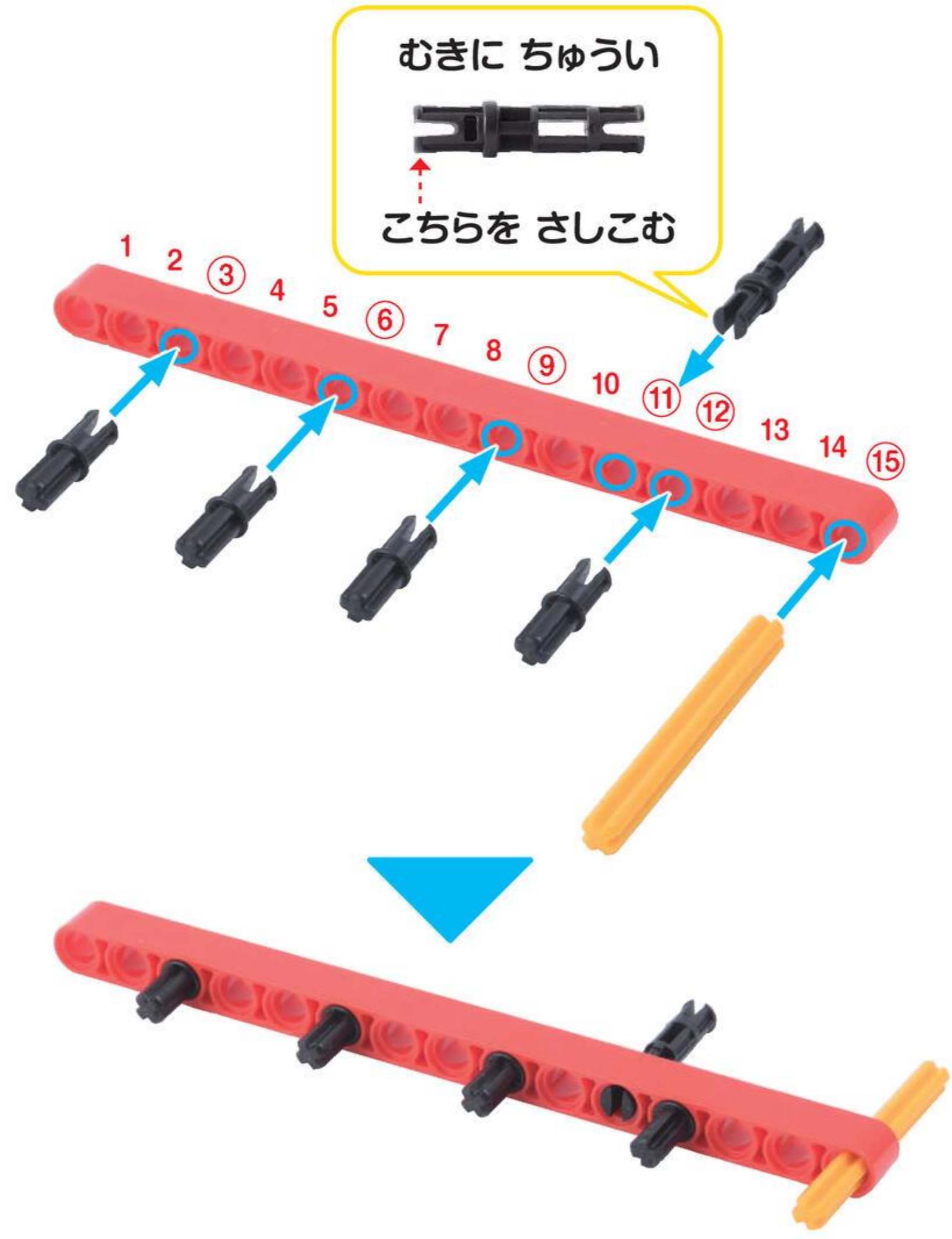



ギア L 1こ

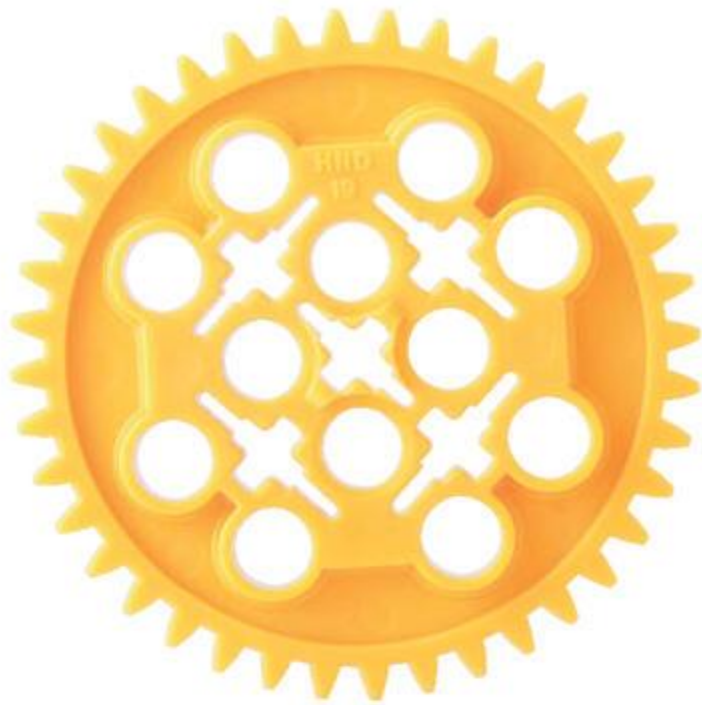

ギア M 5こ

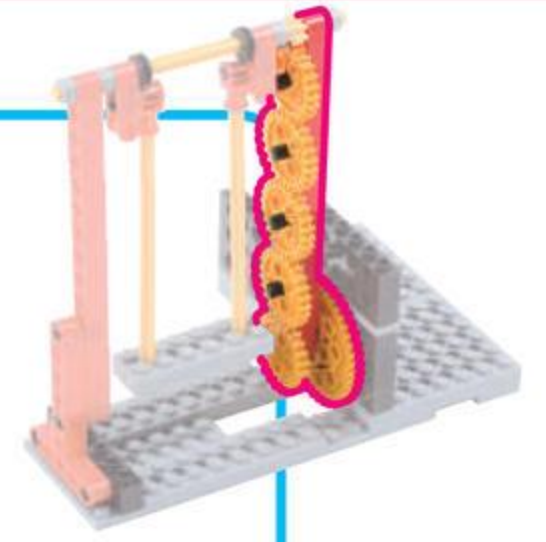
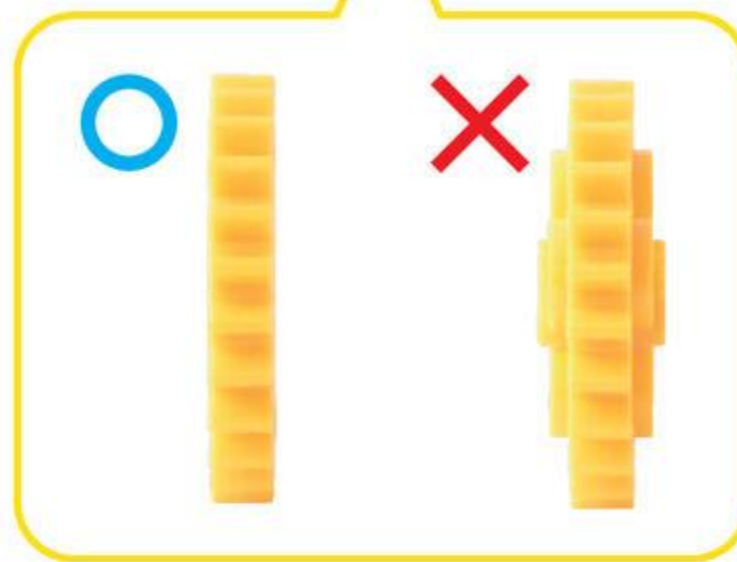

2

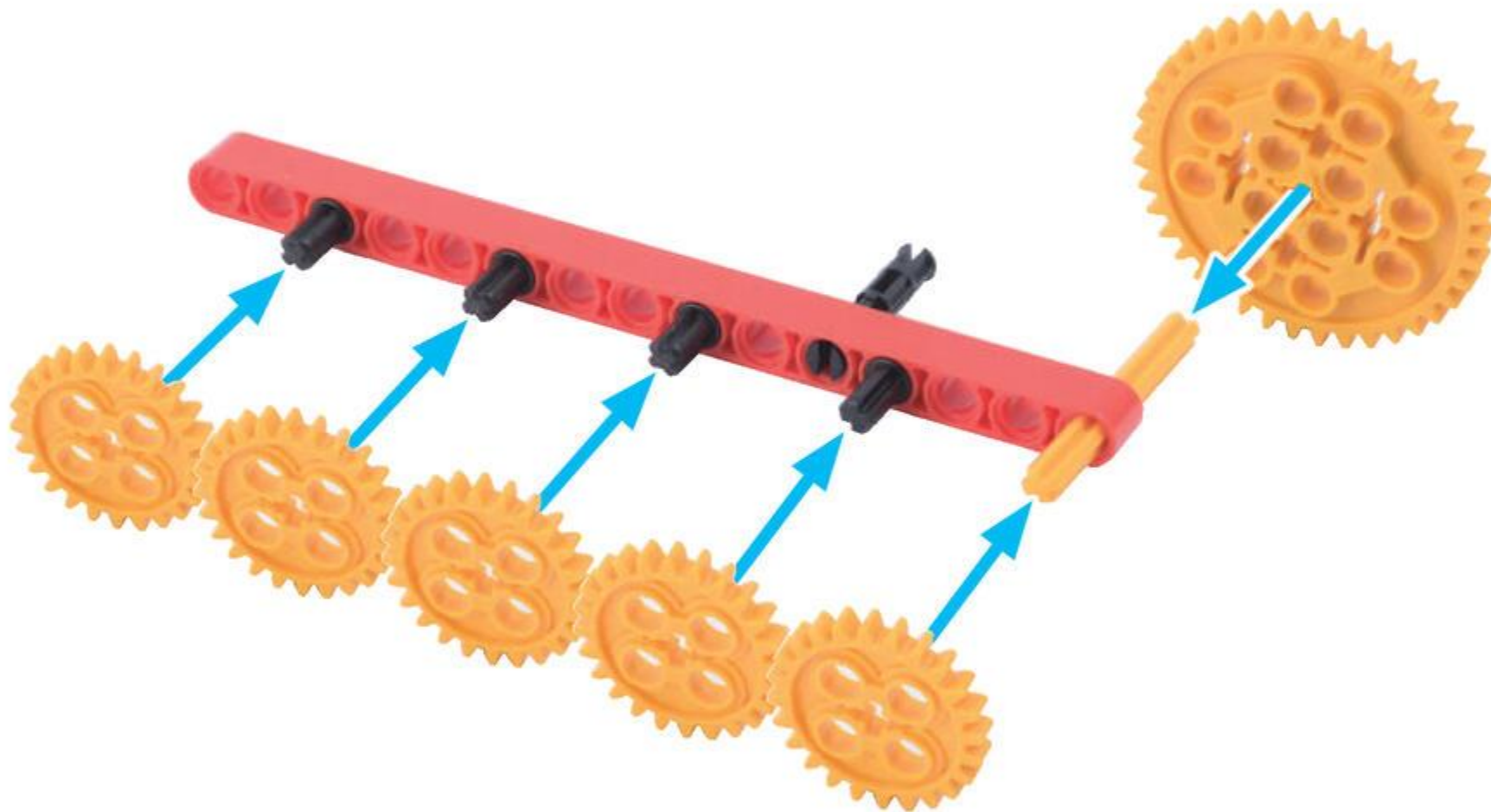



3

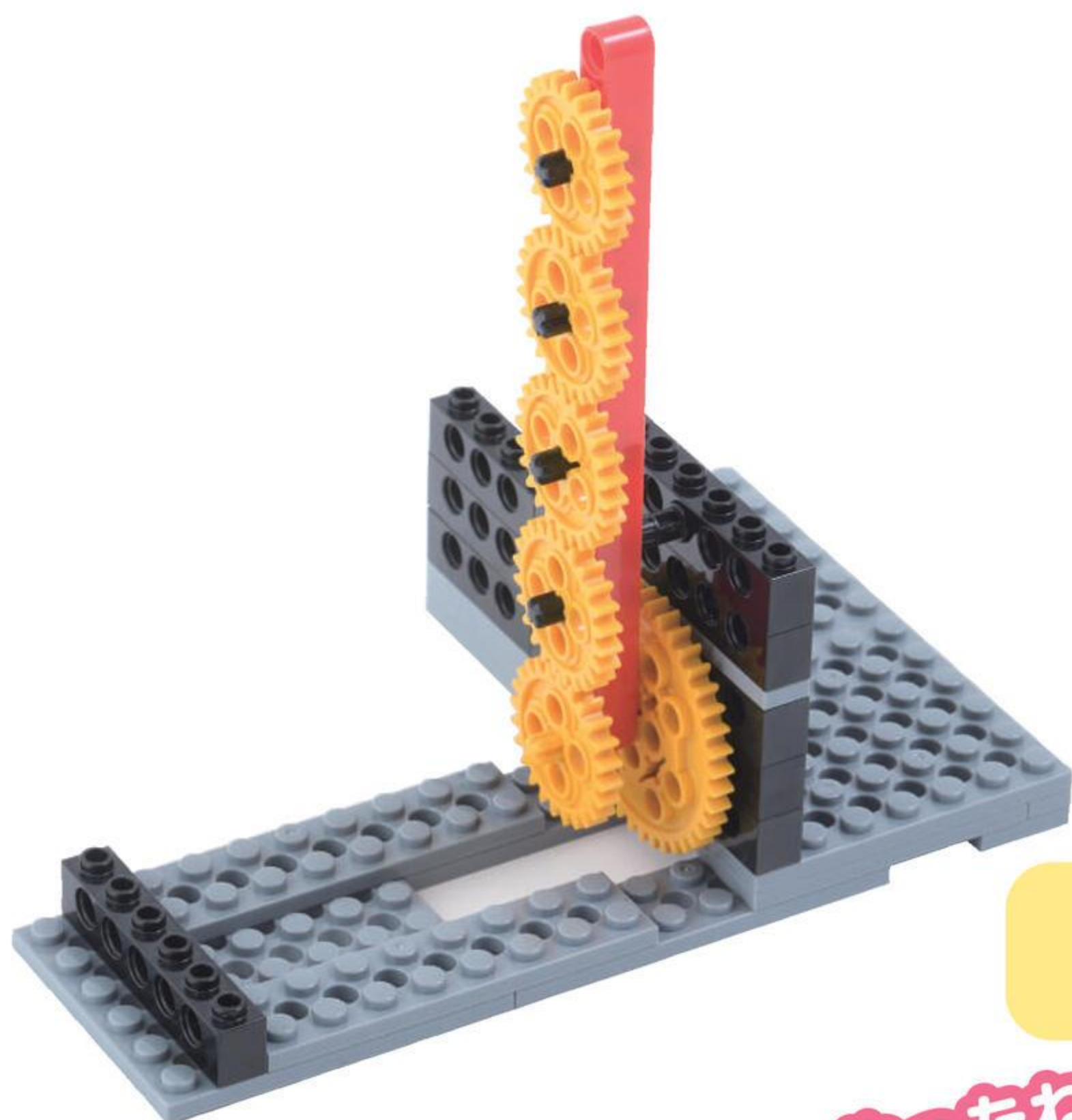
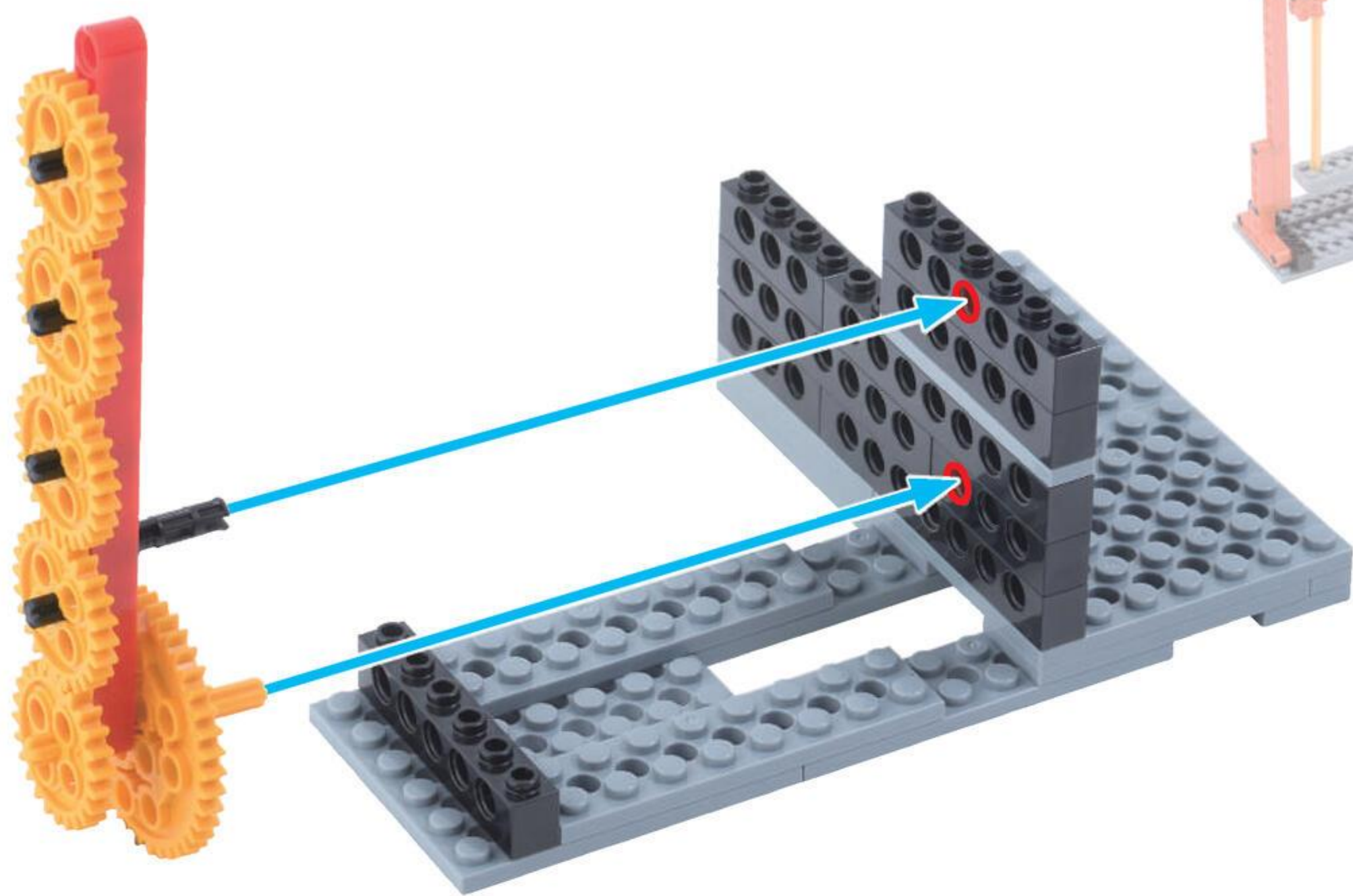

はしらが  
かんせい!

やったね!

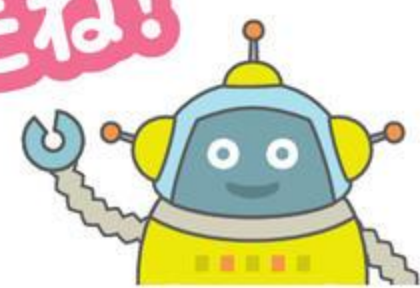



4

ブランコ

めやす 15分

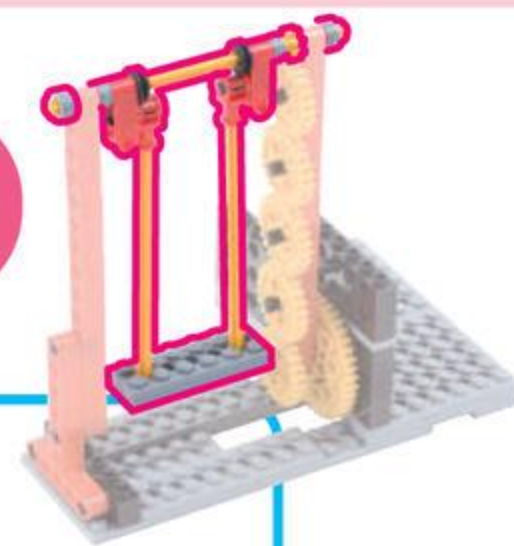

シャフト 12 ポチ 2こ



ブッシュ 2こ



1

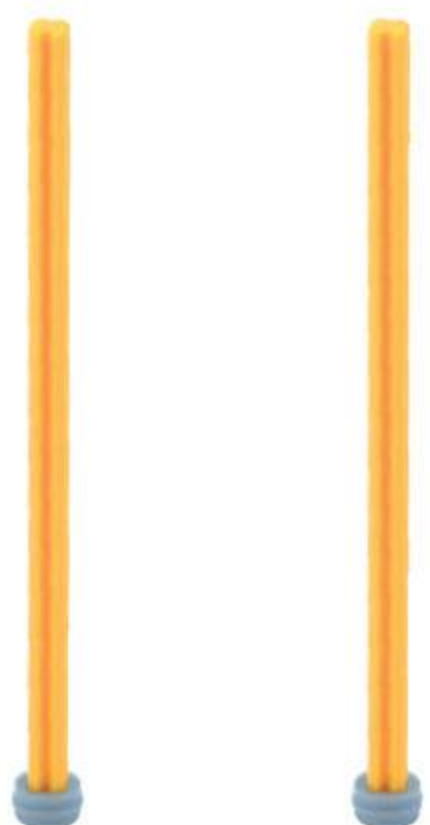



ふとぶれえとろくほち  
太プレート6ポチ 2こ

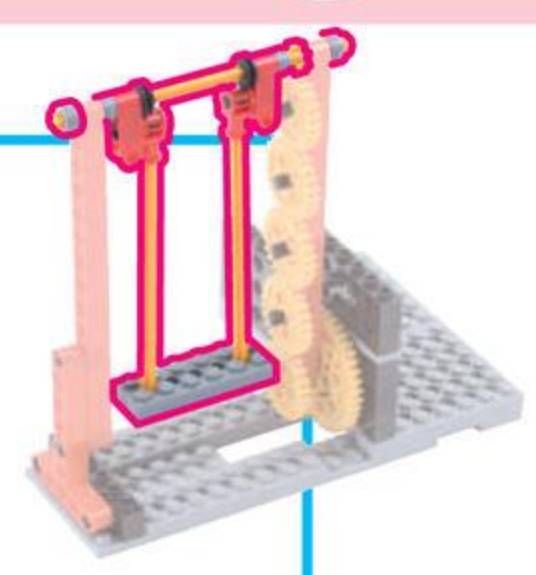

2

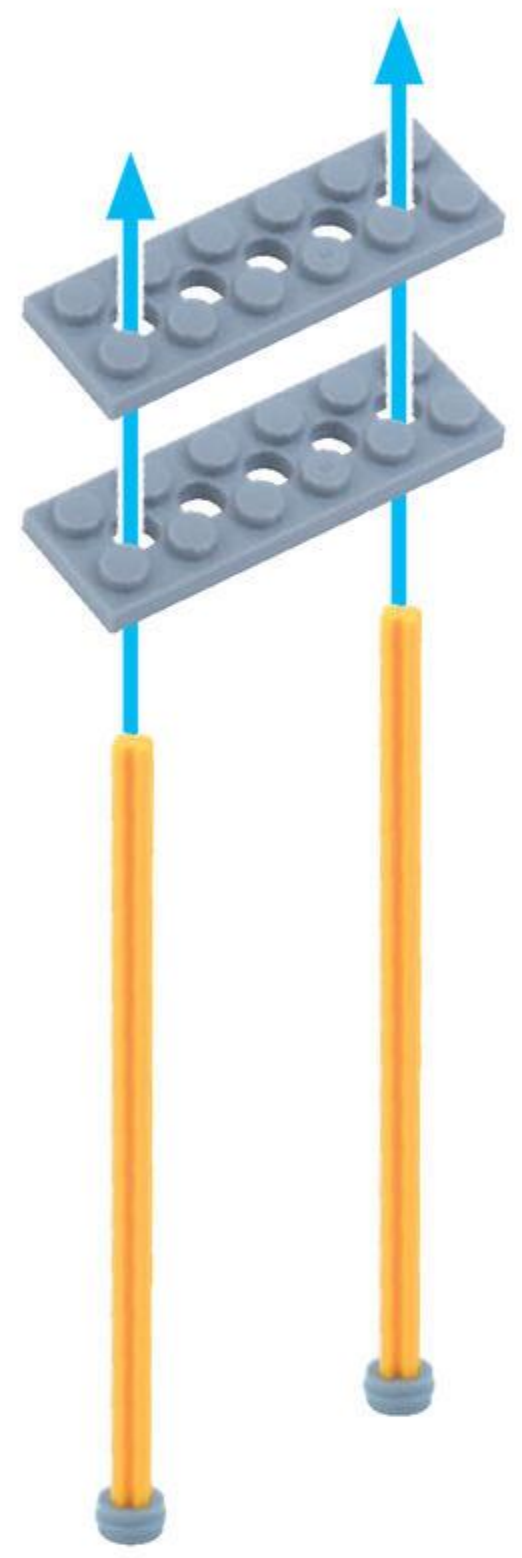



ていじょいんと  
T ジョイント 2こ

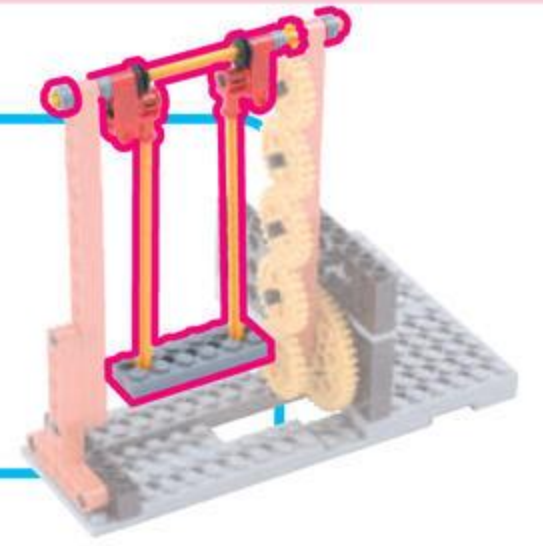

3

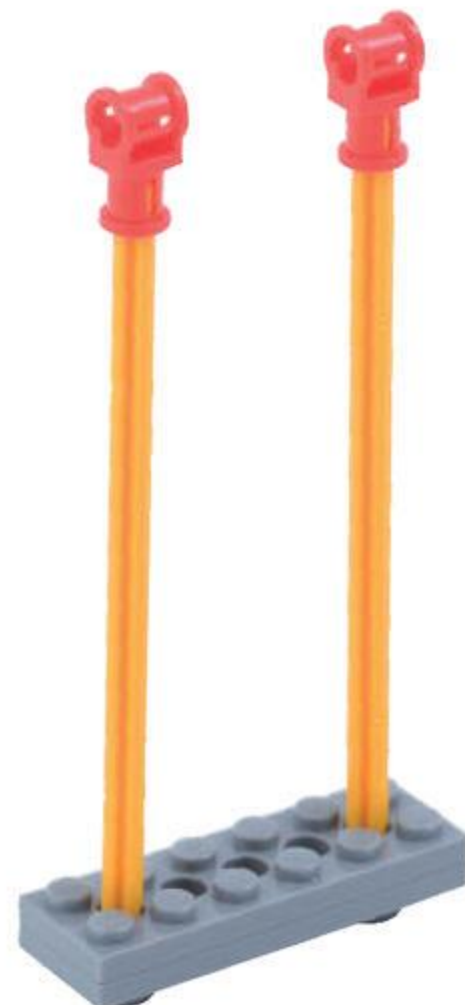
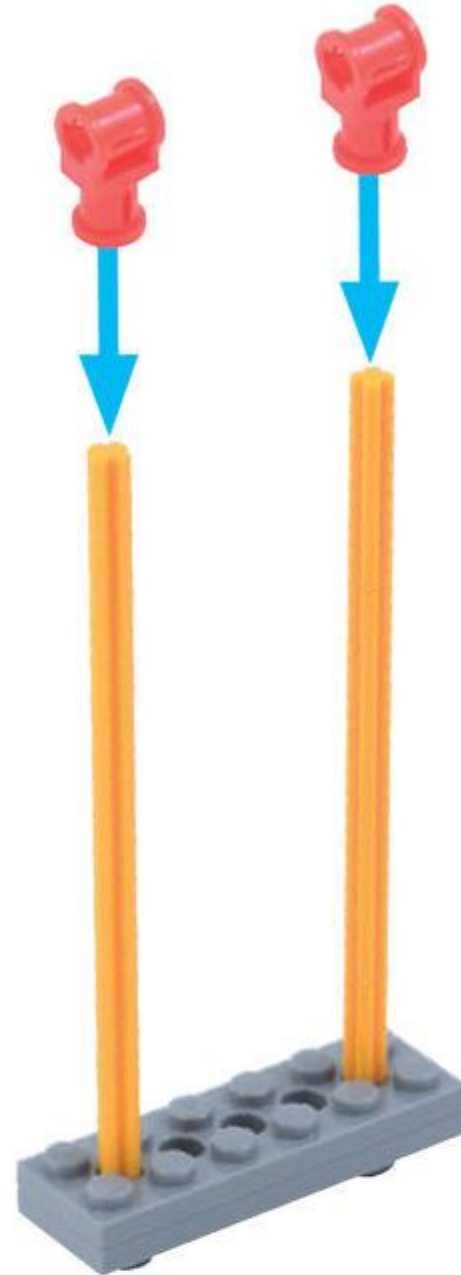



くろすじょいんと  
クロスジョイント 2こ



しゃふとペグ  
シャフトペグ 2こ

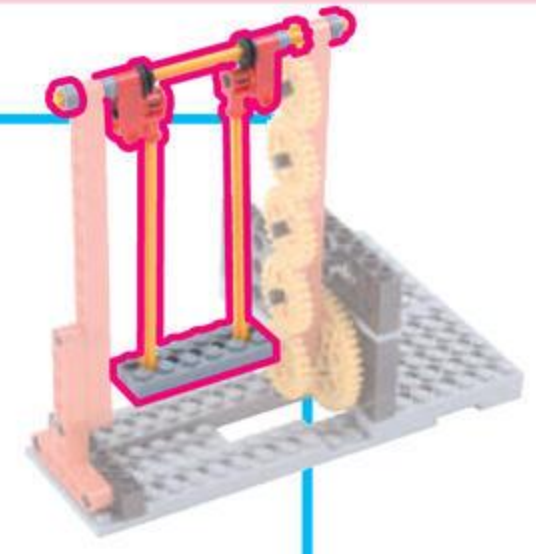

4





しゃふとじゅうにほち  
シャフト 12 ポチ 1こ



ぐろめつと  
グロメット 2こ

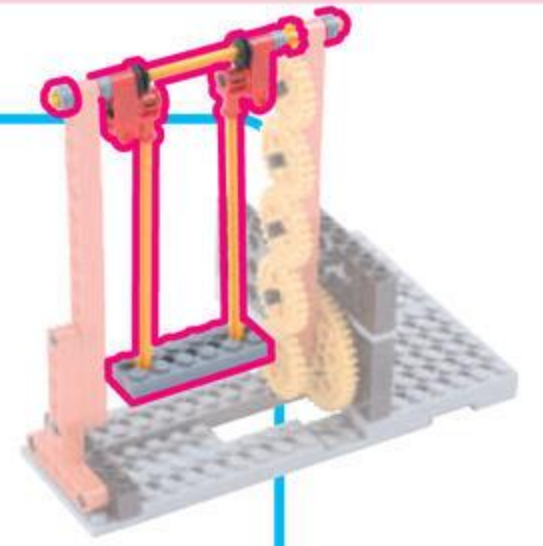

5





ぶっしゅ  
ブッシュ 2こ



びにおんぎあ  
ピニオンギアうす 1こ

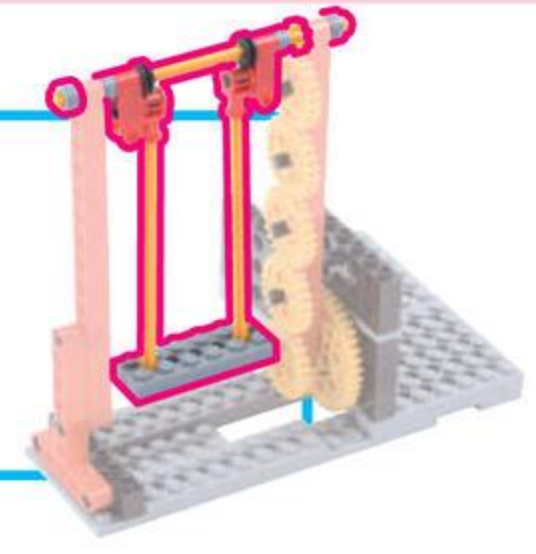

6

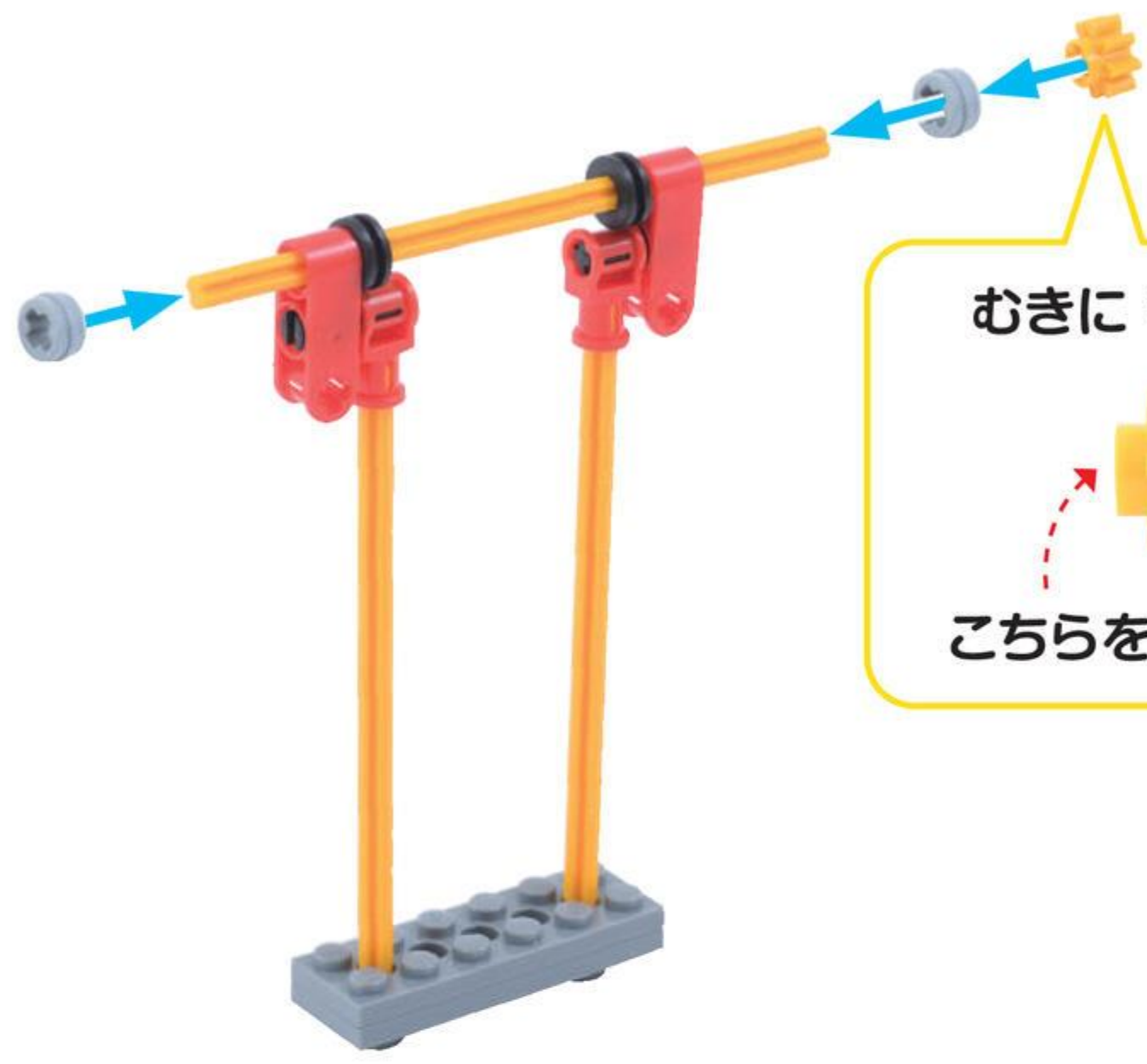

むきに ちゅうい  
こちらを さしこむ





ぶっしゅ  
ブッシュ 1こ

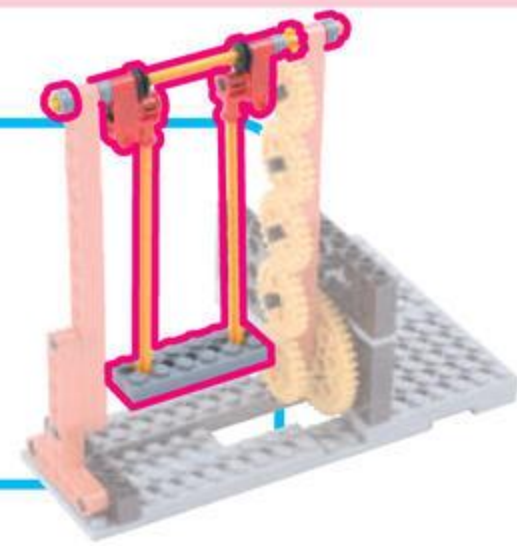

7

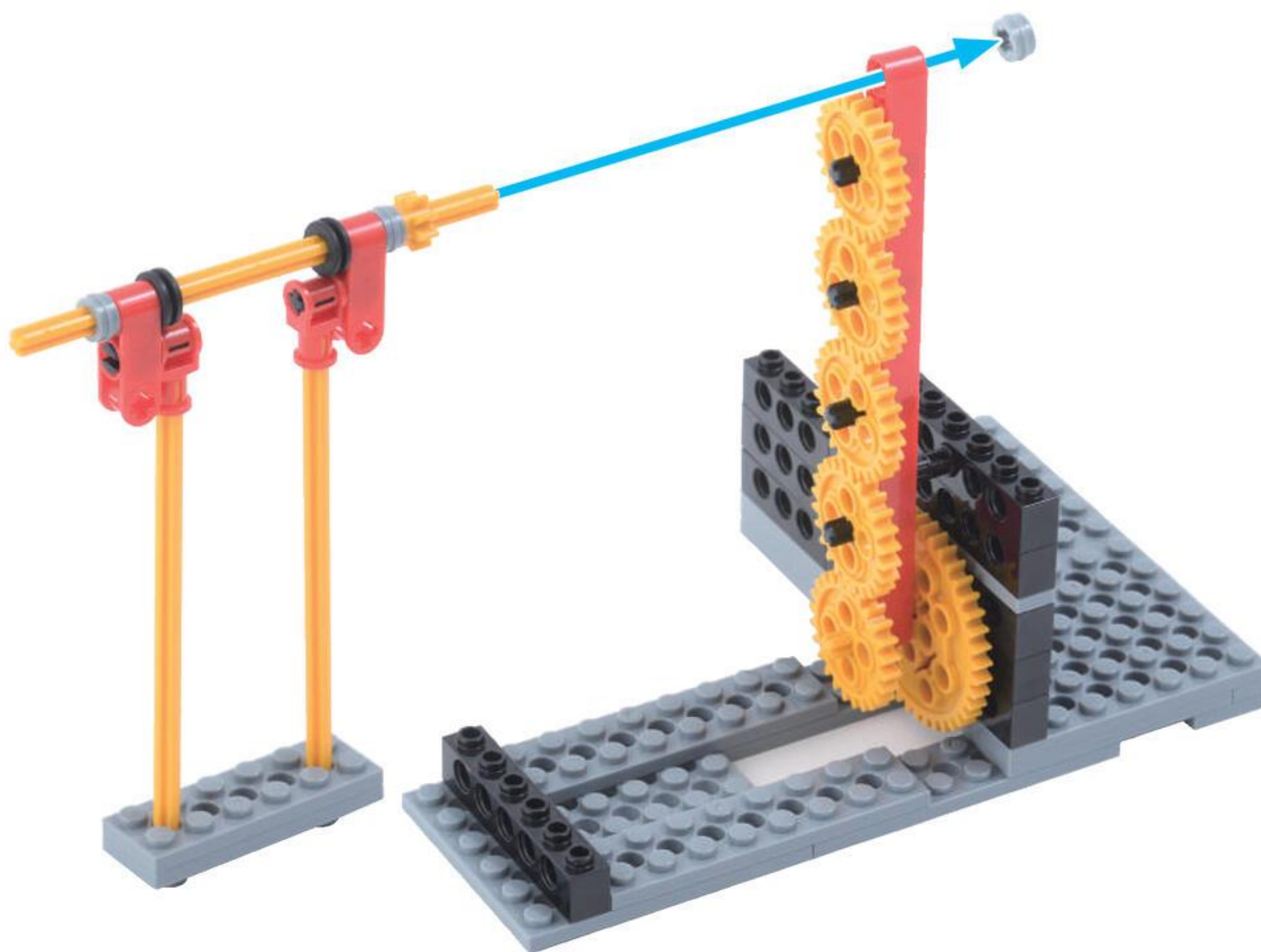

しっかり かみあわせよう

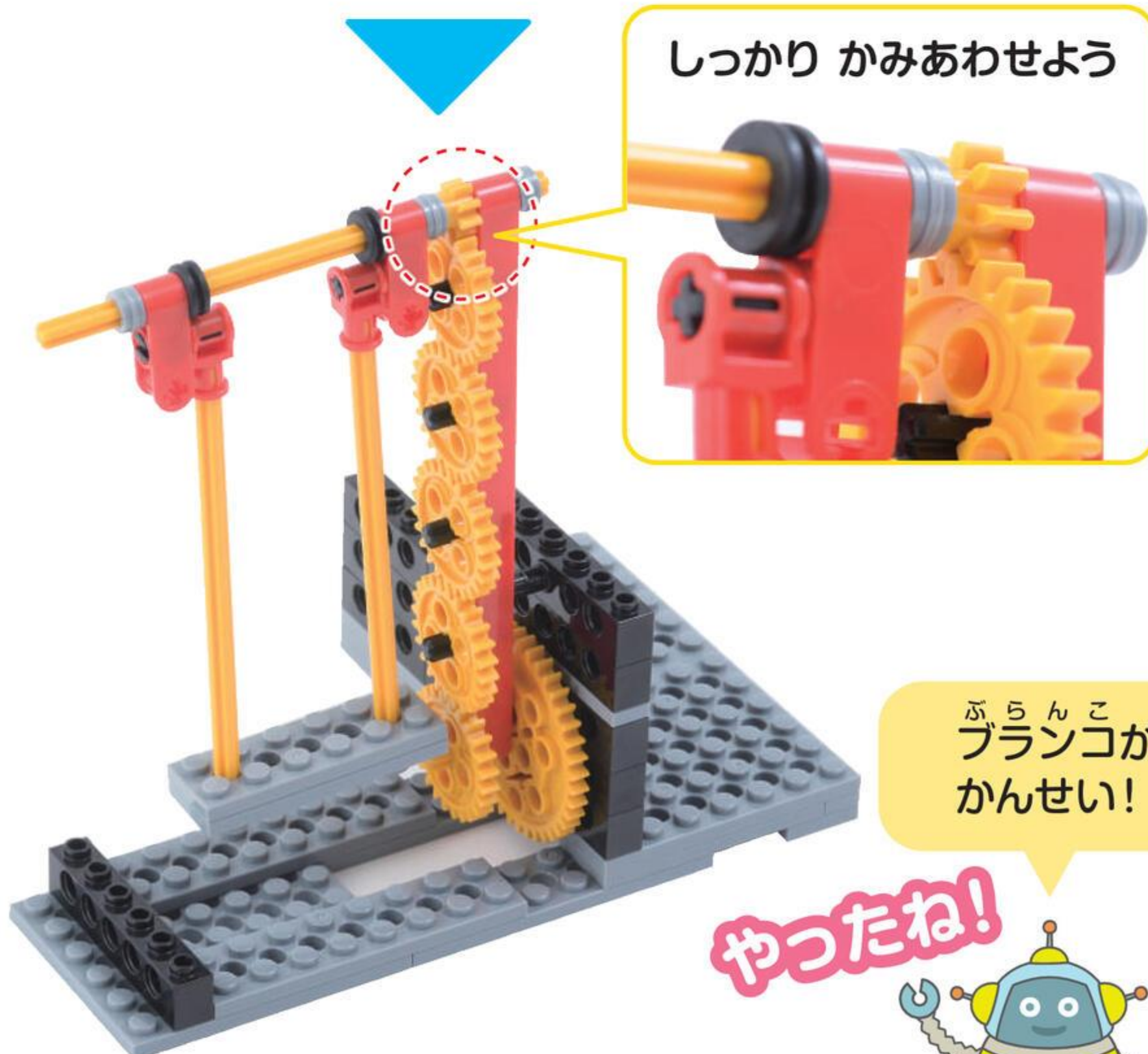

ぶらんこ  
ブランコが  
かんせい!

やったね!

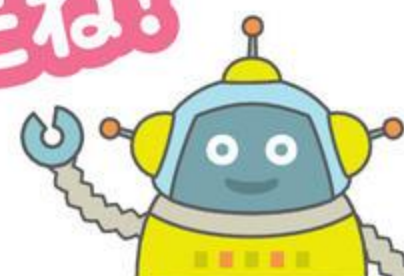



5 もう1つのはしら めやす 5 ぶん

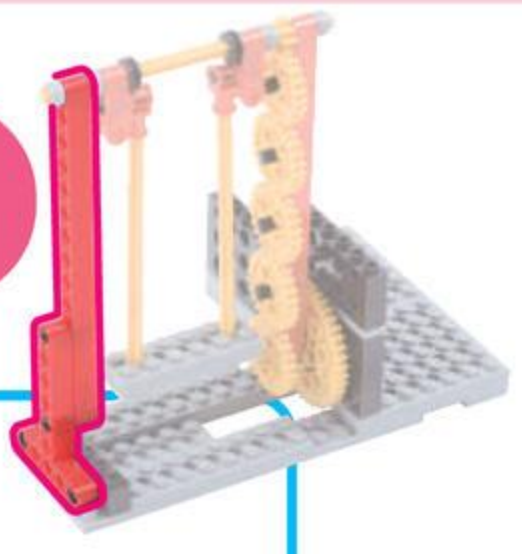

てい るっど T ロッド 1こ

ぺぐ えす S 4こ

1

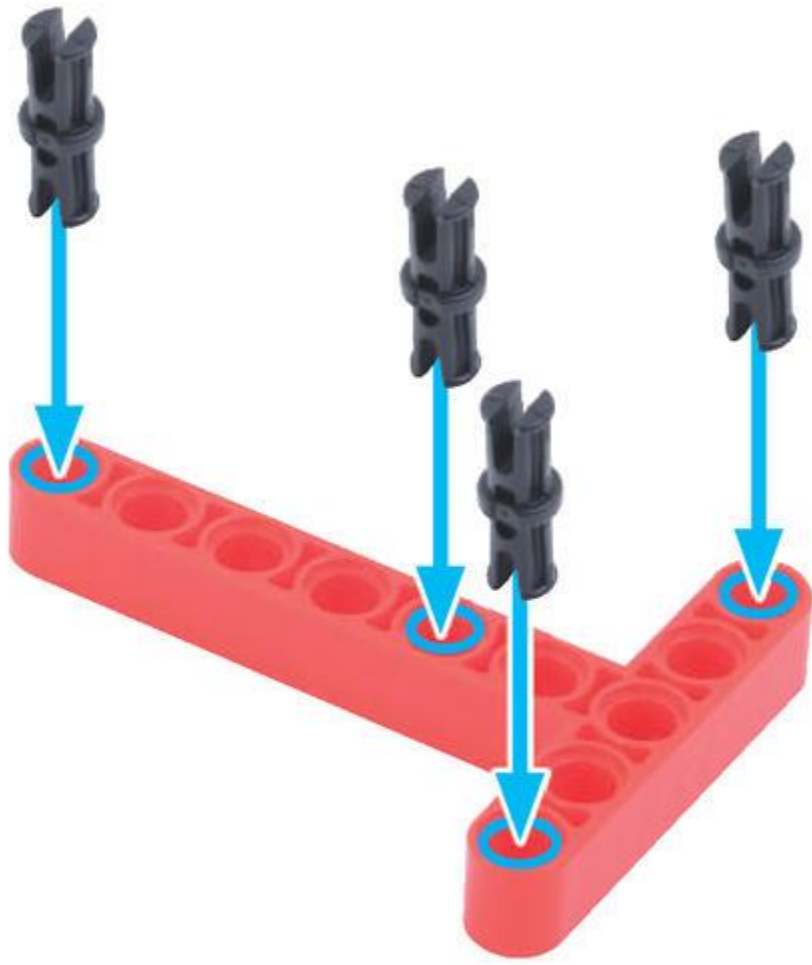



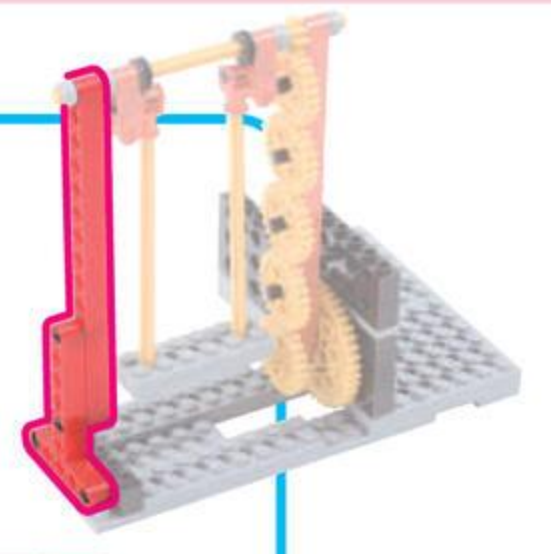

ろっど 15 アナ 1こ



2

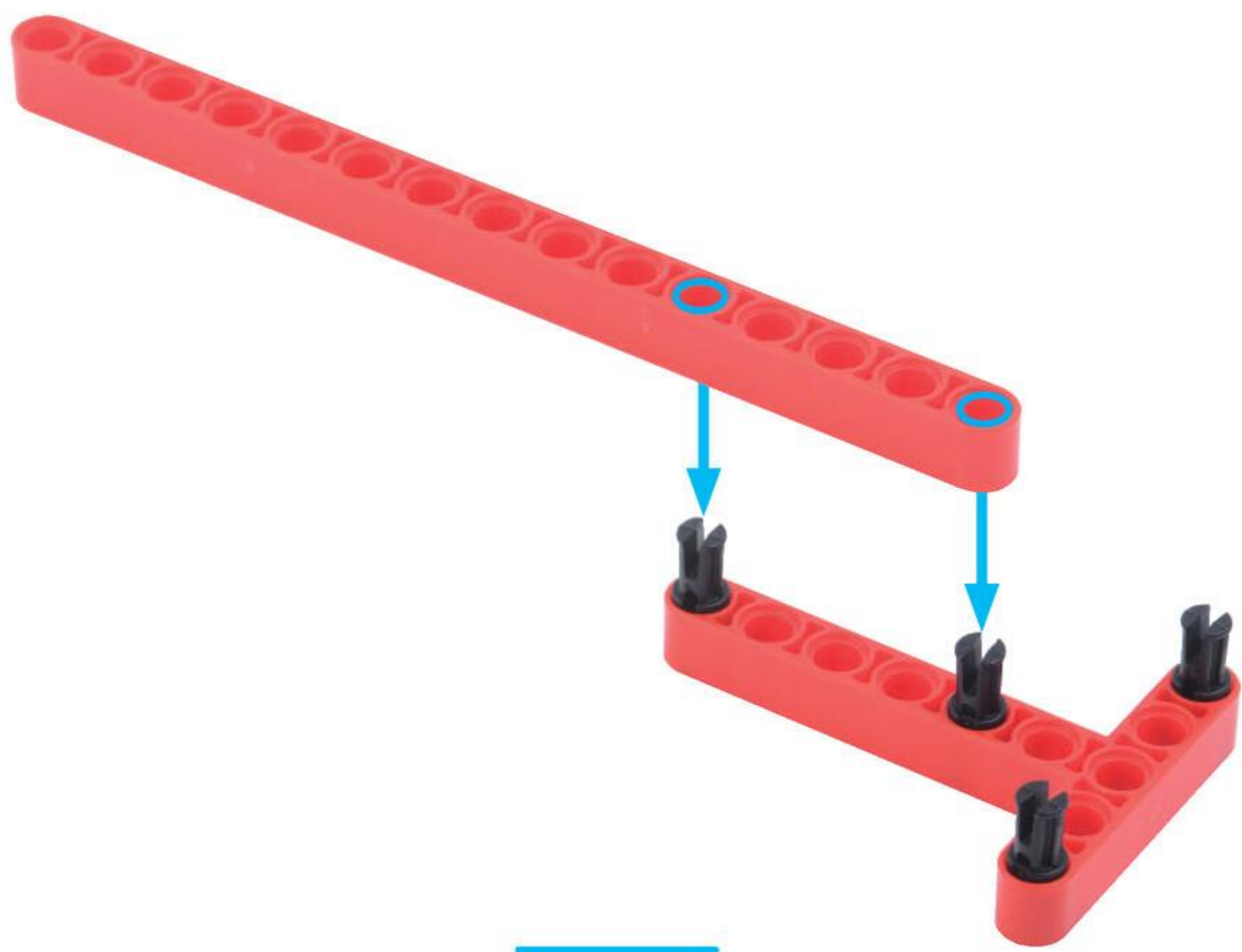



ぶっしゅ  
ブッシュ 1こ

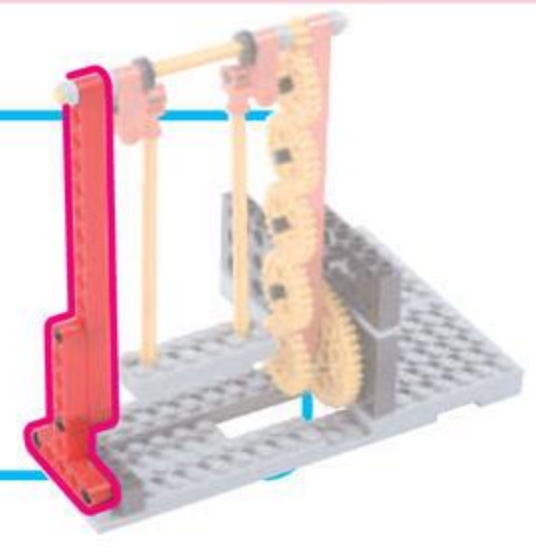

3

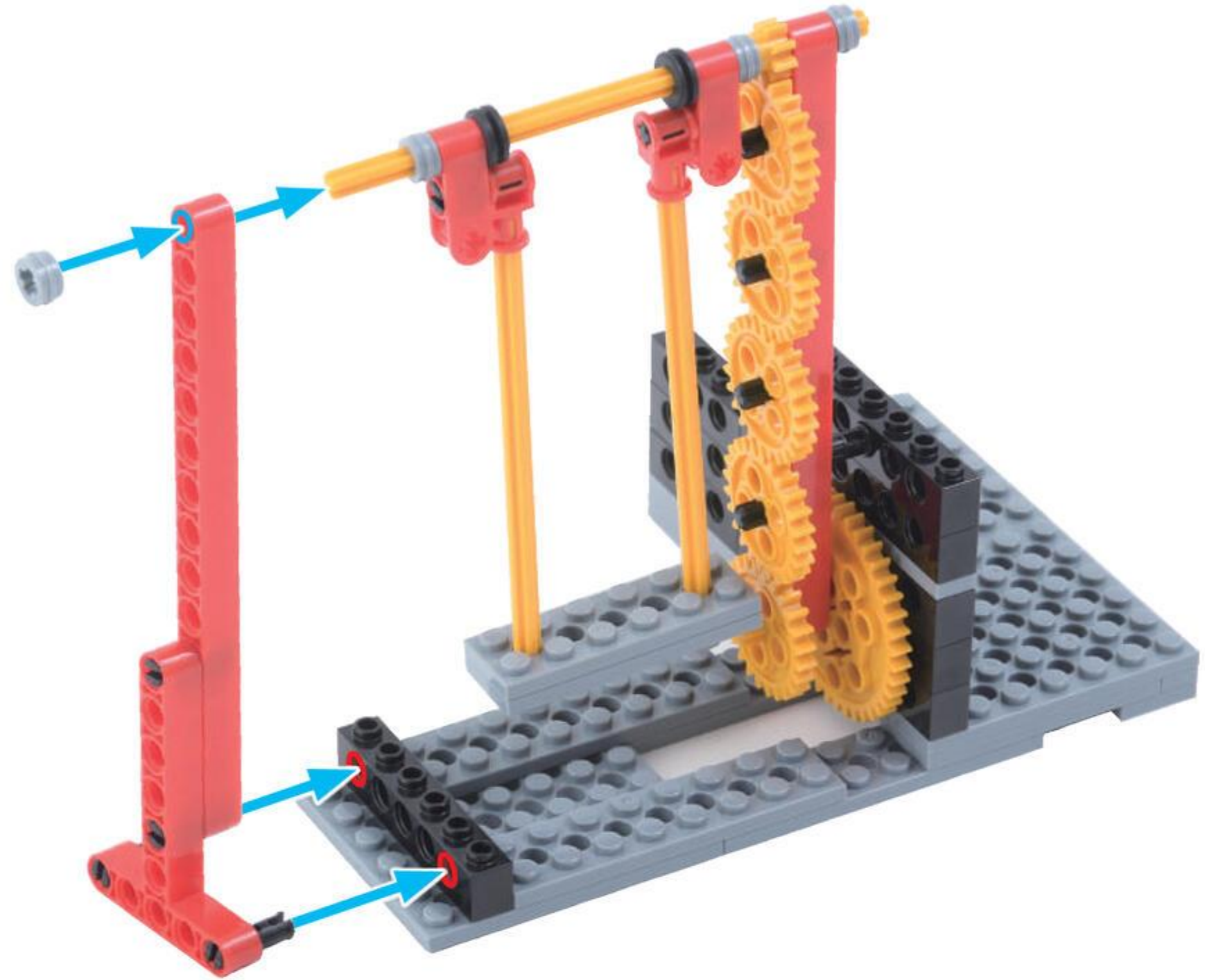

これで  
かんせい!

よくできました!





ろぼっと  
ロボットを うごかさう

めやす 10 ぶん

くらんく 1こ



1

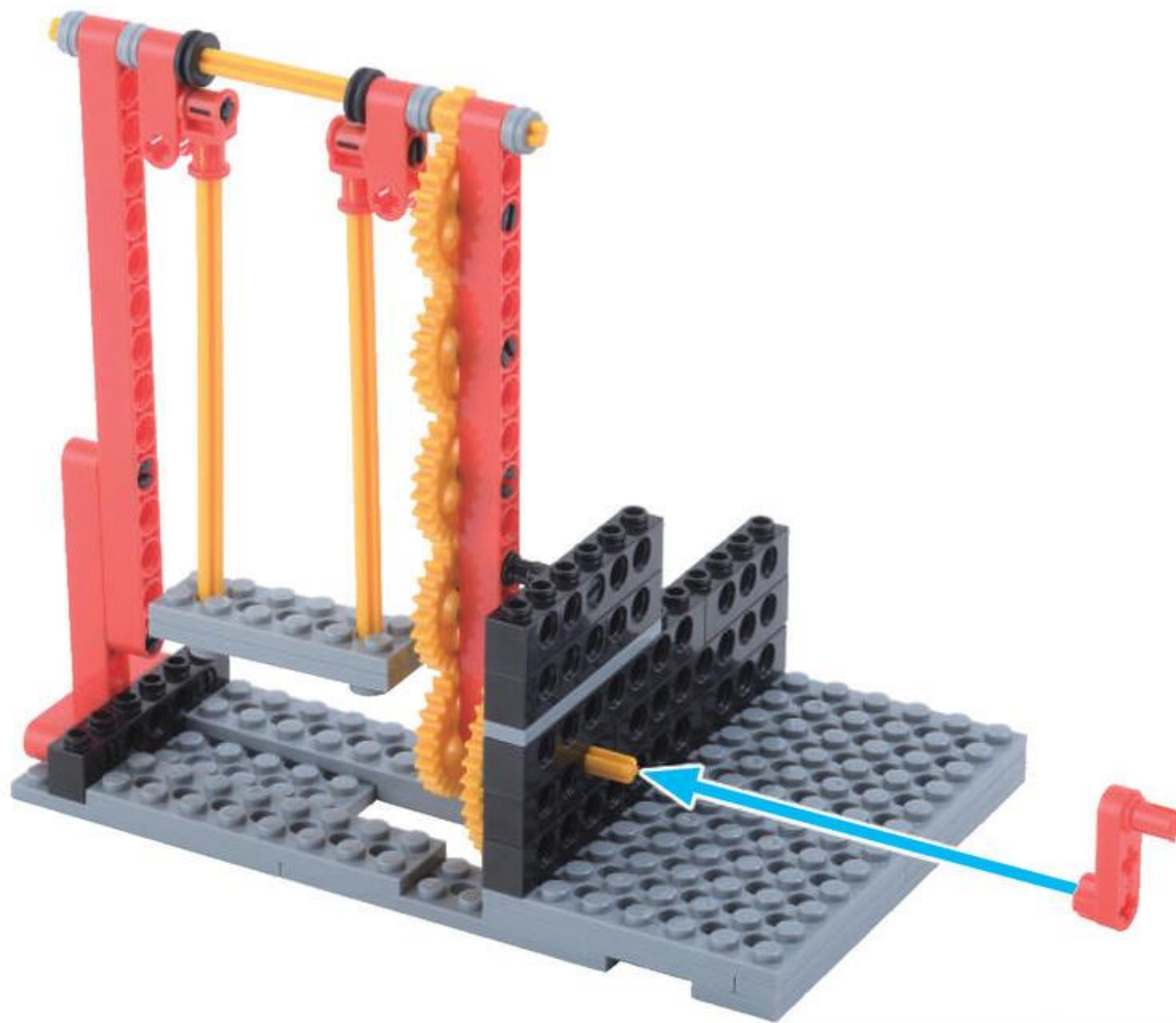



ぶらんこ  
ブランコを てで  
ささえながら  
ぱいろっと  
パイロットを  
のせよう

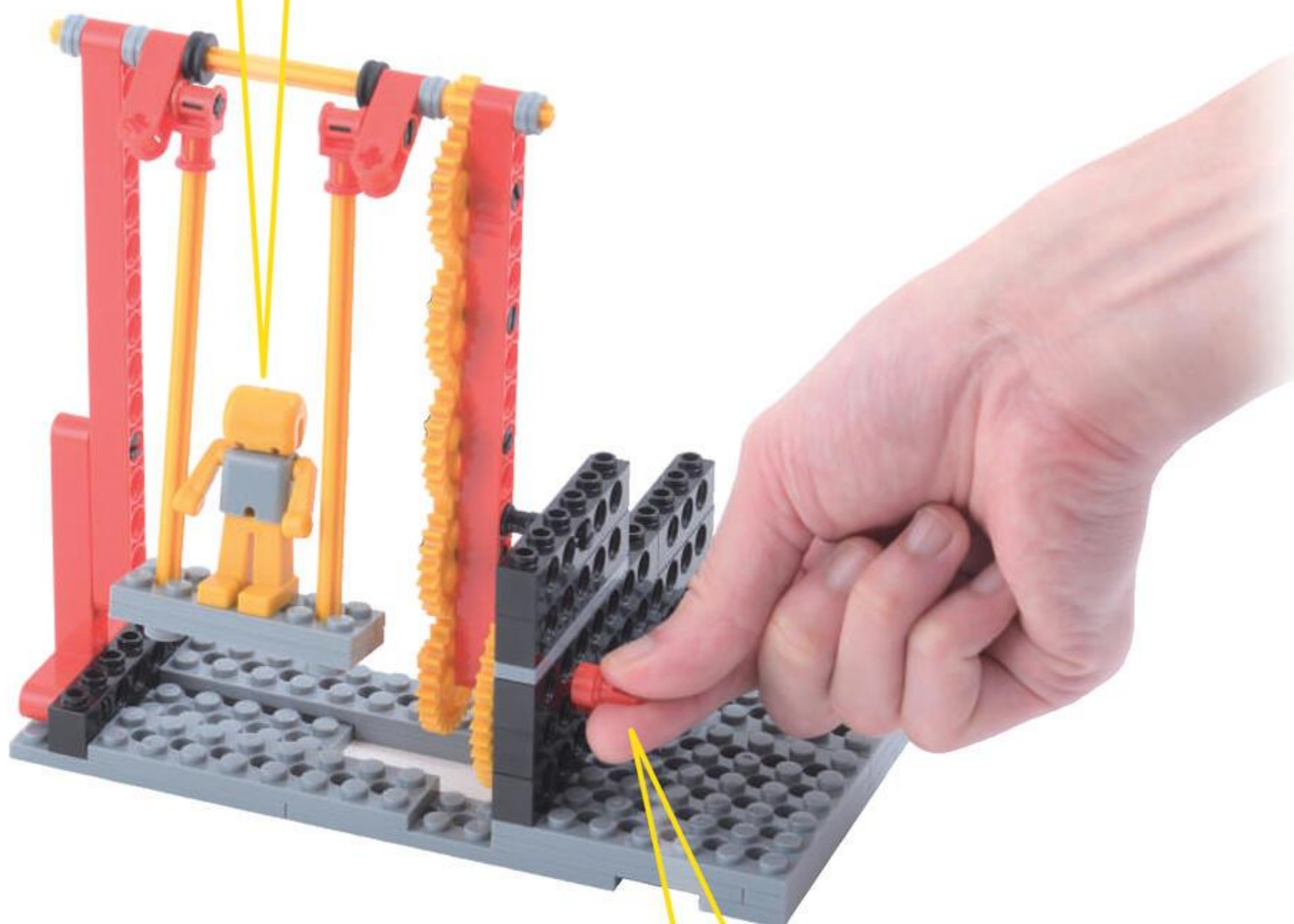

やじるしの ように  
くらんく  
クランクを うごかそう

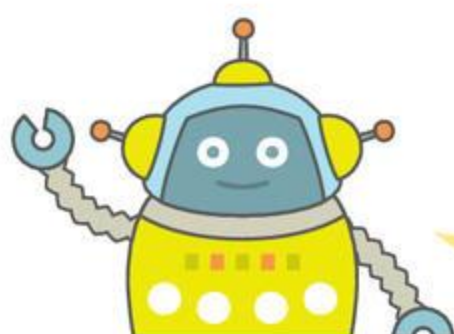
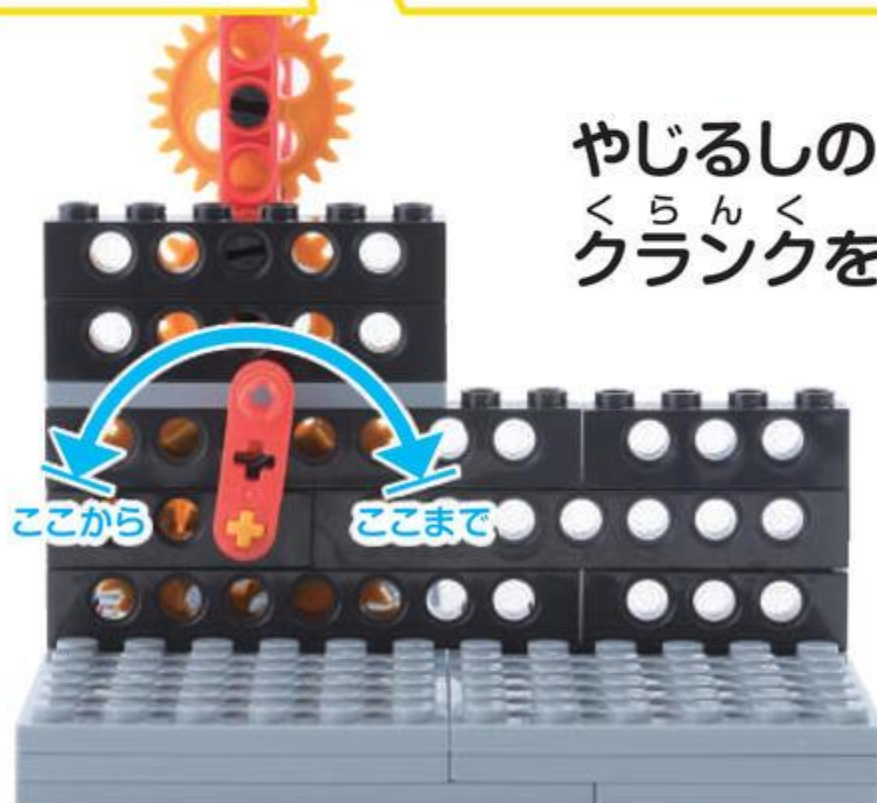

じかいは <sup>も お た あ</sup> モーターで うごくように  
かいぞう してい くよ



Q1 <sup>てい</sup>T <sup>じょいんと</sup>ジョイントをさがそう! どれかな? 

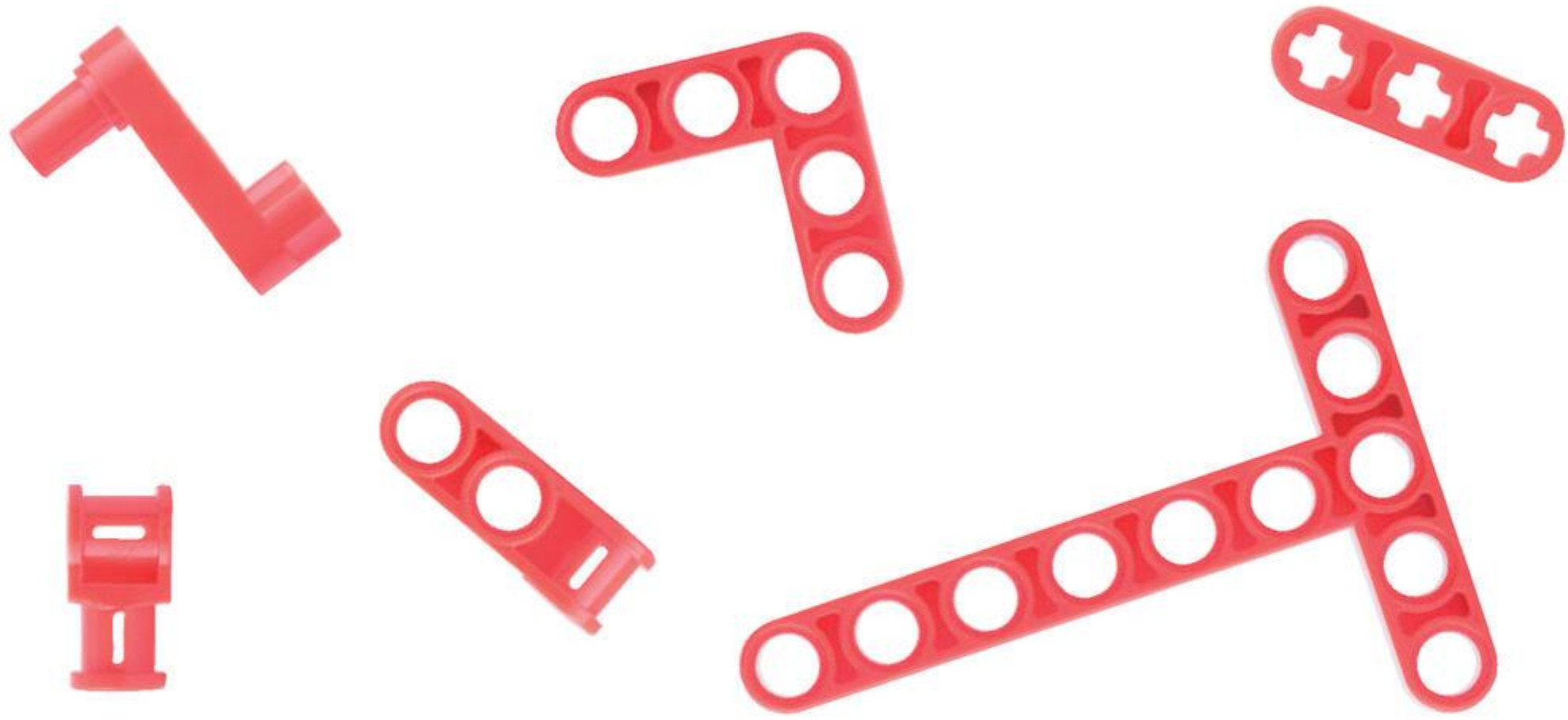

Q2 <sup>くろす</sup>クロスジョイントには <sup>ペグ</sup>ペグ <sup>えす</sup>S をなんことりつけられるかな?



ペグ <sup>えす</sup>S

( 1 こ ・ 2 こ ・ 3 こ ) 

Q3 <sup>くろす</sup>クロスジョイントには <sup>しゃふと</sup>シャフト <sup>ペグ</sup>ペグ をなんことりつけられるかな?



しゃふとペグ

( 1 こ ・ 2 こ ・ 3 こ ) 





Human

ヒューマンアカデミー ジュニア  
STEAMスクール



ロボット教室

# ロボットのきょうかしよ

プレプライマリーコース 回

2

ぶらんこロボ「ゆらりん」



★だい2かい

2023 ねん

11 がつ

にち

なまえ



もくじ

だい 2 かい

きょうの よてい	39	2ふん
くみたて		
1. ギアボックス	40~57	
ロボットを うごかそう	58	
くみたて		
2. あたらしい じめん	59~62	80ふん
3. あたらしい ブラシ	63~67	
4. あたらしい はしら	68~70	
ロボットを うごかそう	71	
じゆうに かいぞう してみよう	72	
まちがい さがし	73	3ふん
かたづけ		5ふん

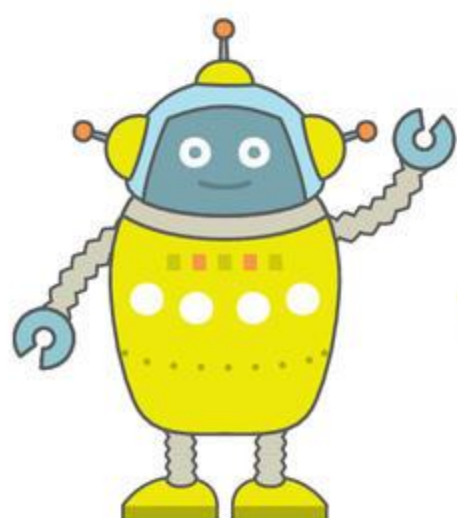
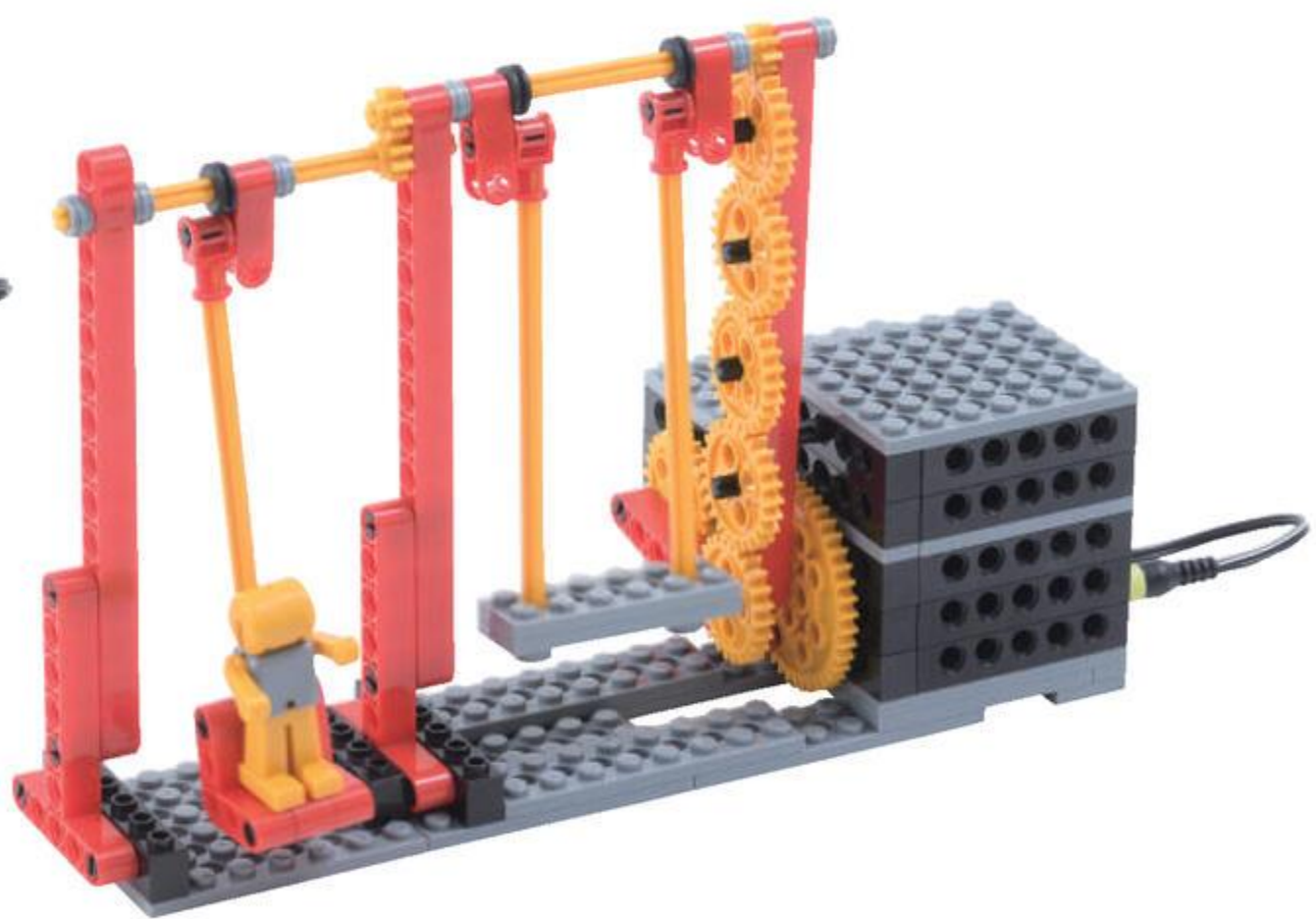
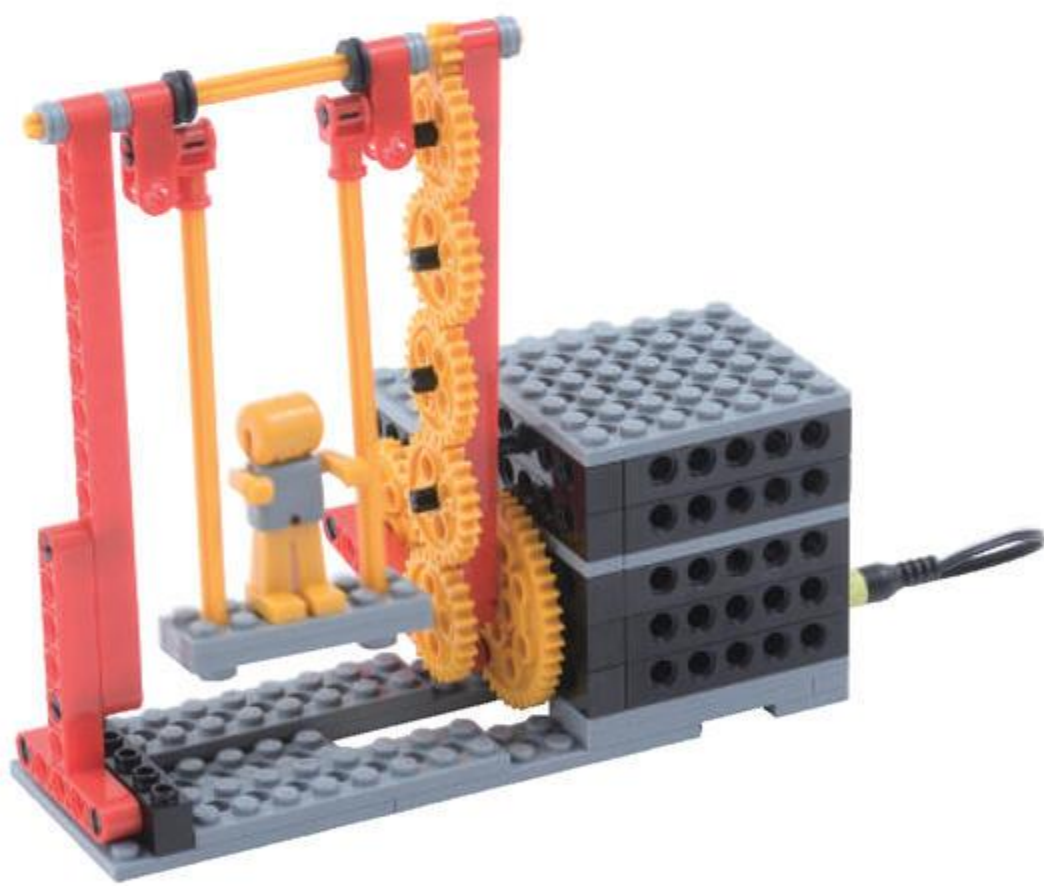

こんかいは <sup>も お た あ</sup> モーターで  
 ロボットを うごかすよ



# きょうの よてい

めやす 2 ふん

このじゅんばんでつくるよ!

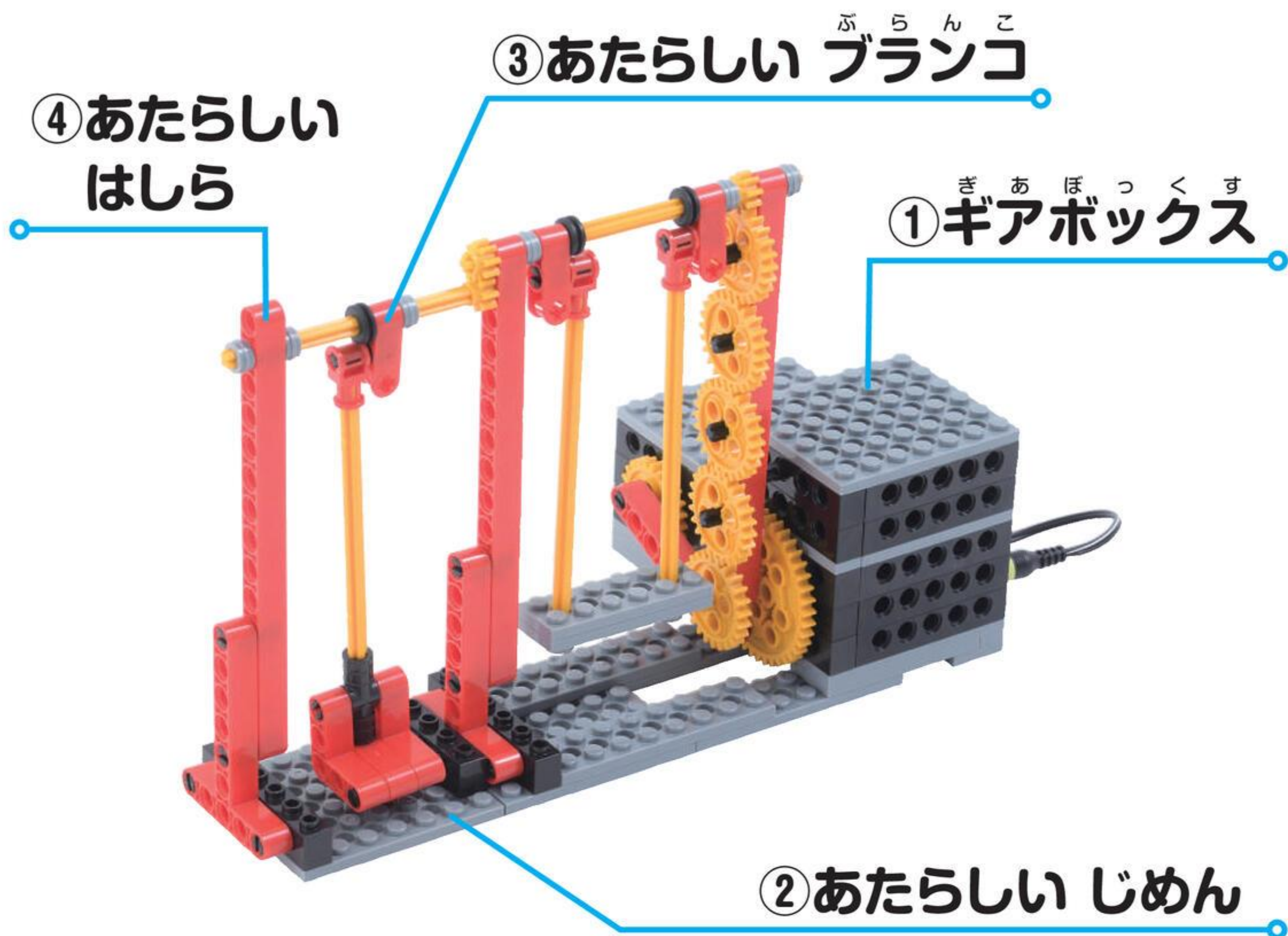

①ギアボックス

②あたらしいじめん

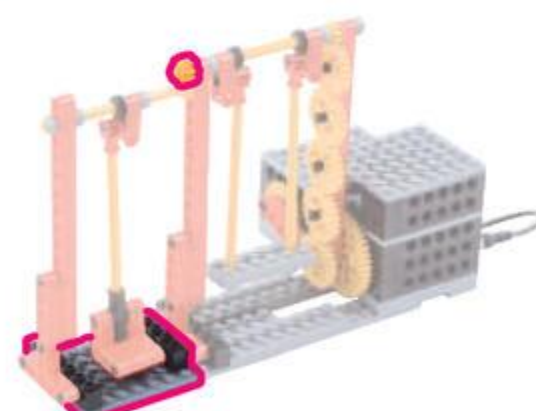
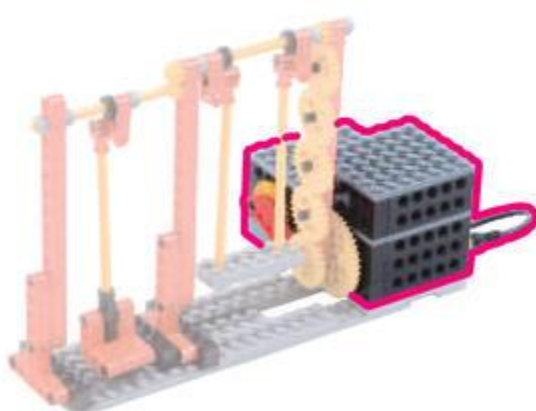

③あたらしいブランコ

④あたらしいはしら

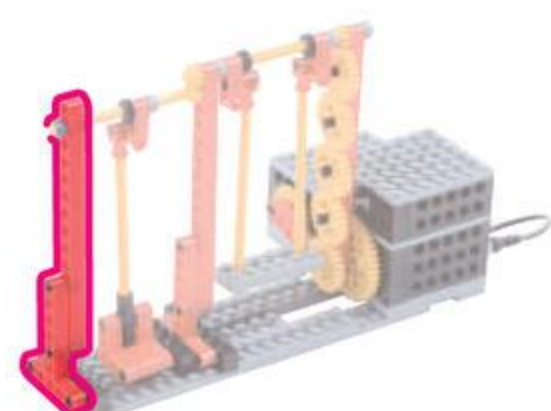
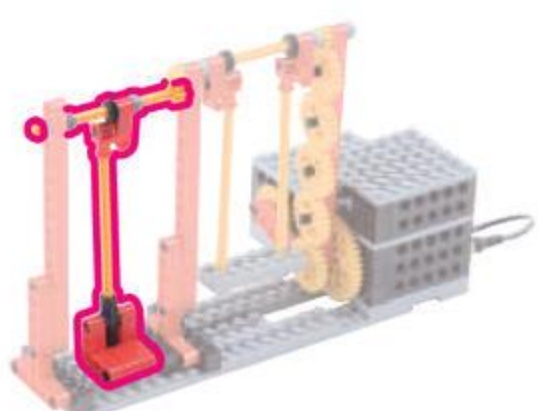



1

ギアボックス

めやす 25 ぶん

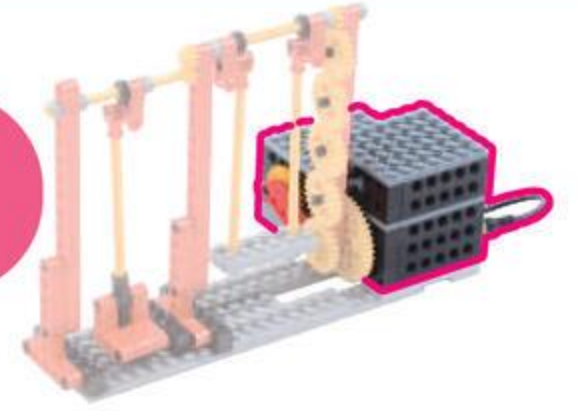

1

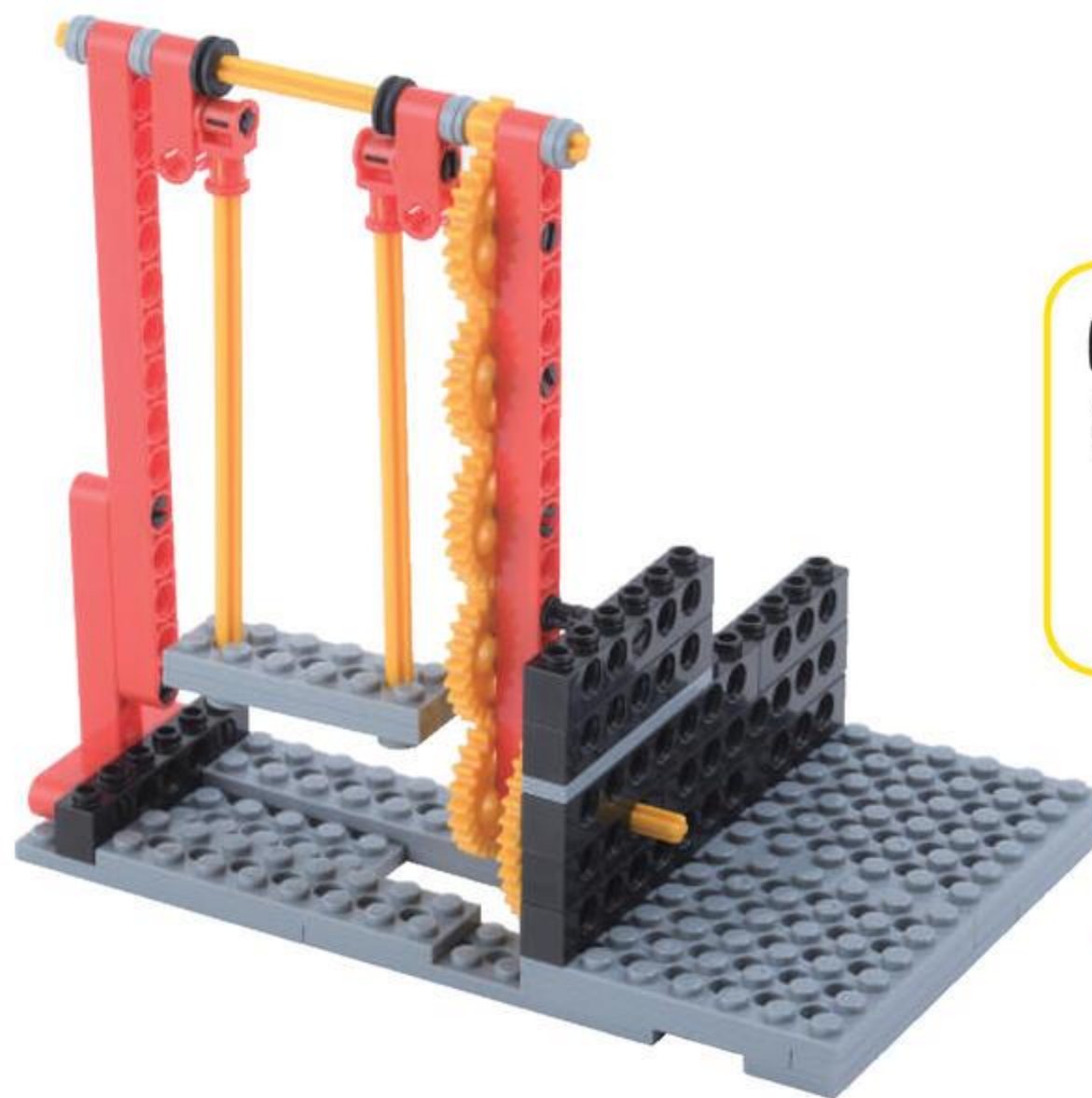
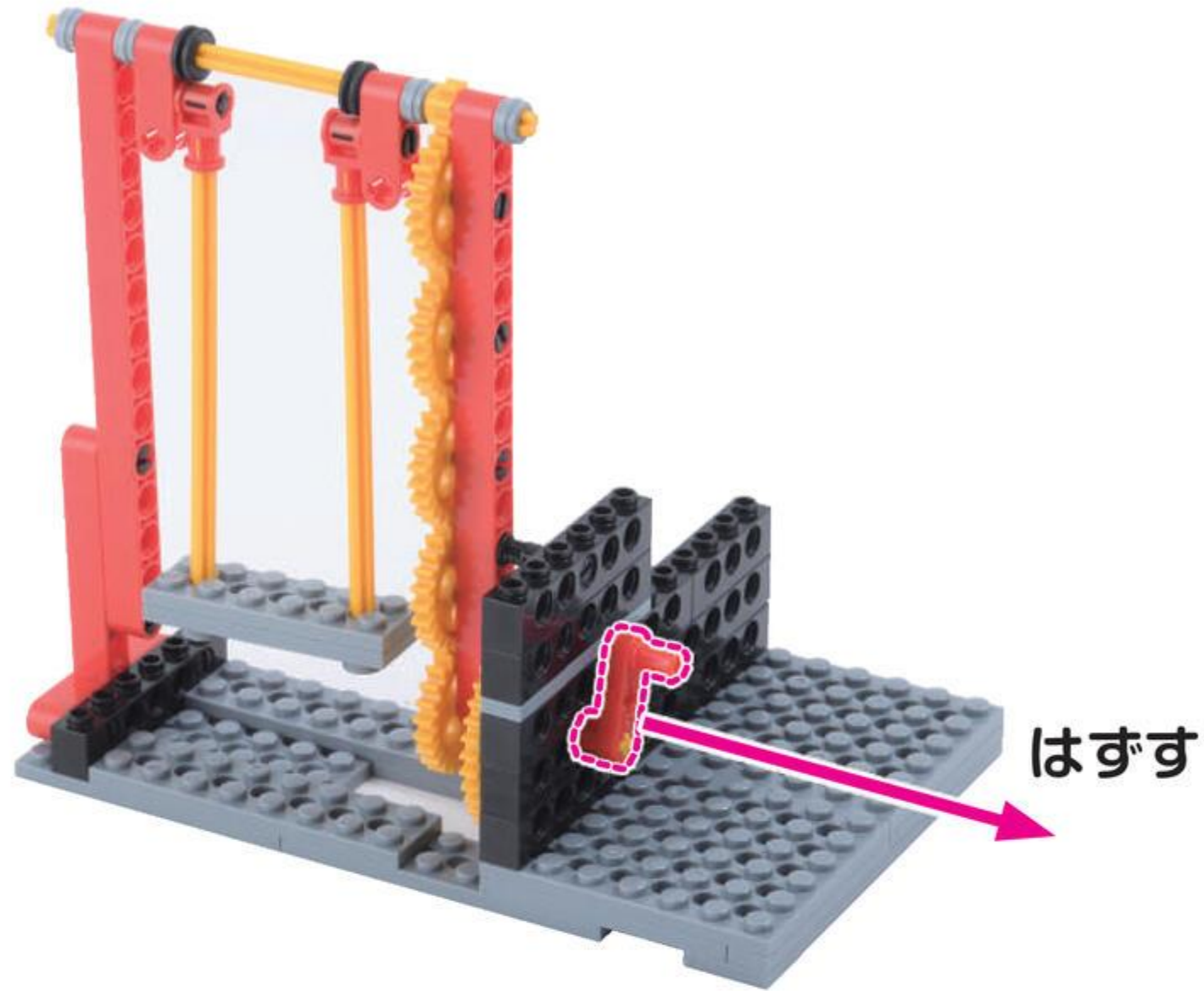



2

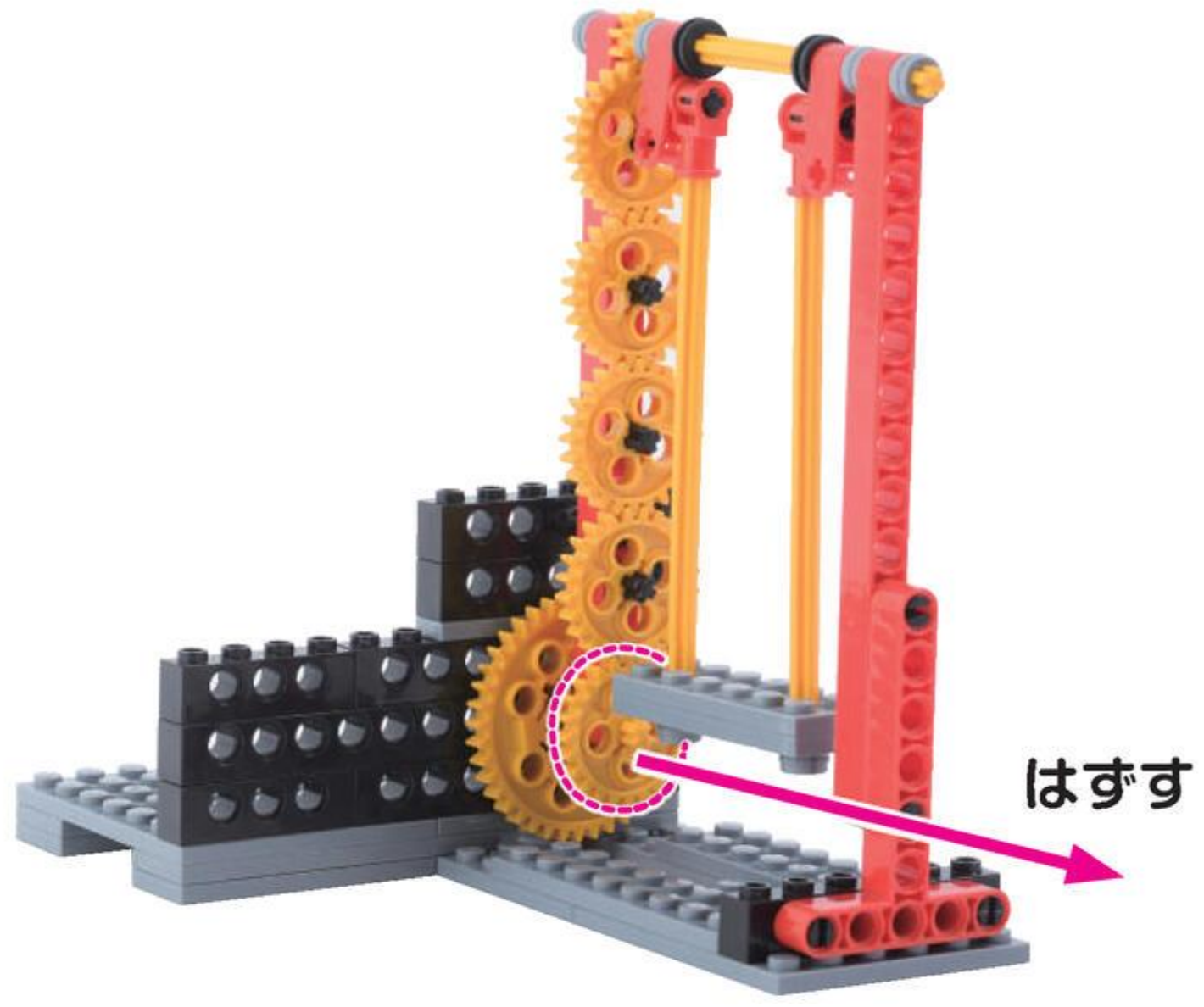
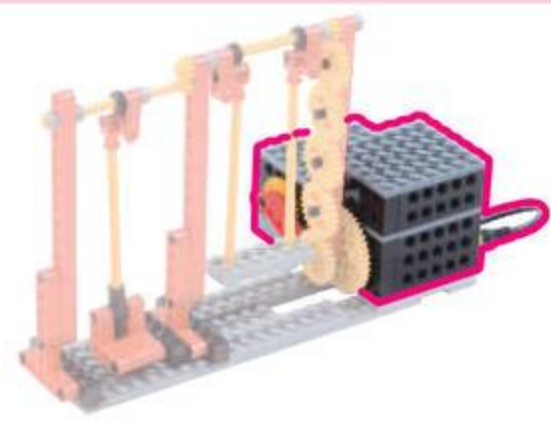



ぎあえむ  
ギア M 1こ

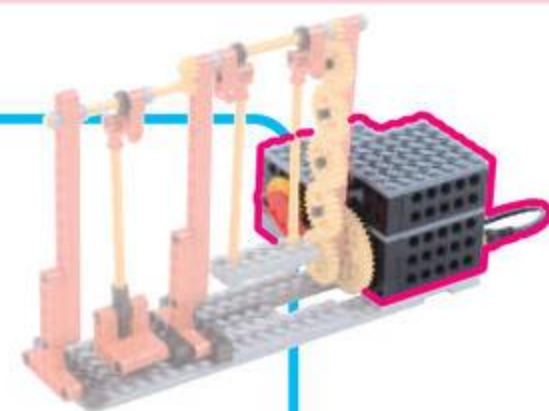
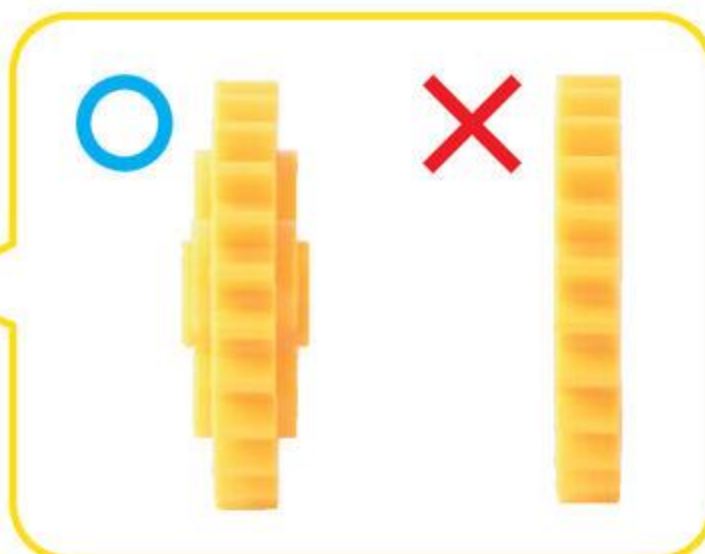

しゃふとさほち  
シャフト 3ポチ 1こ



ながさに  
ちゅうい

3

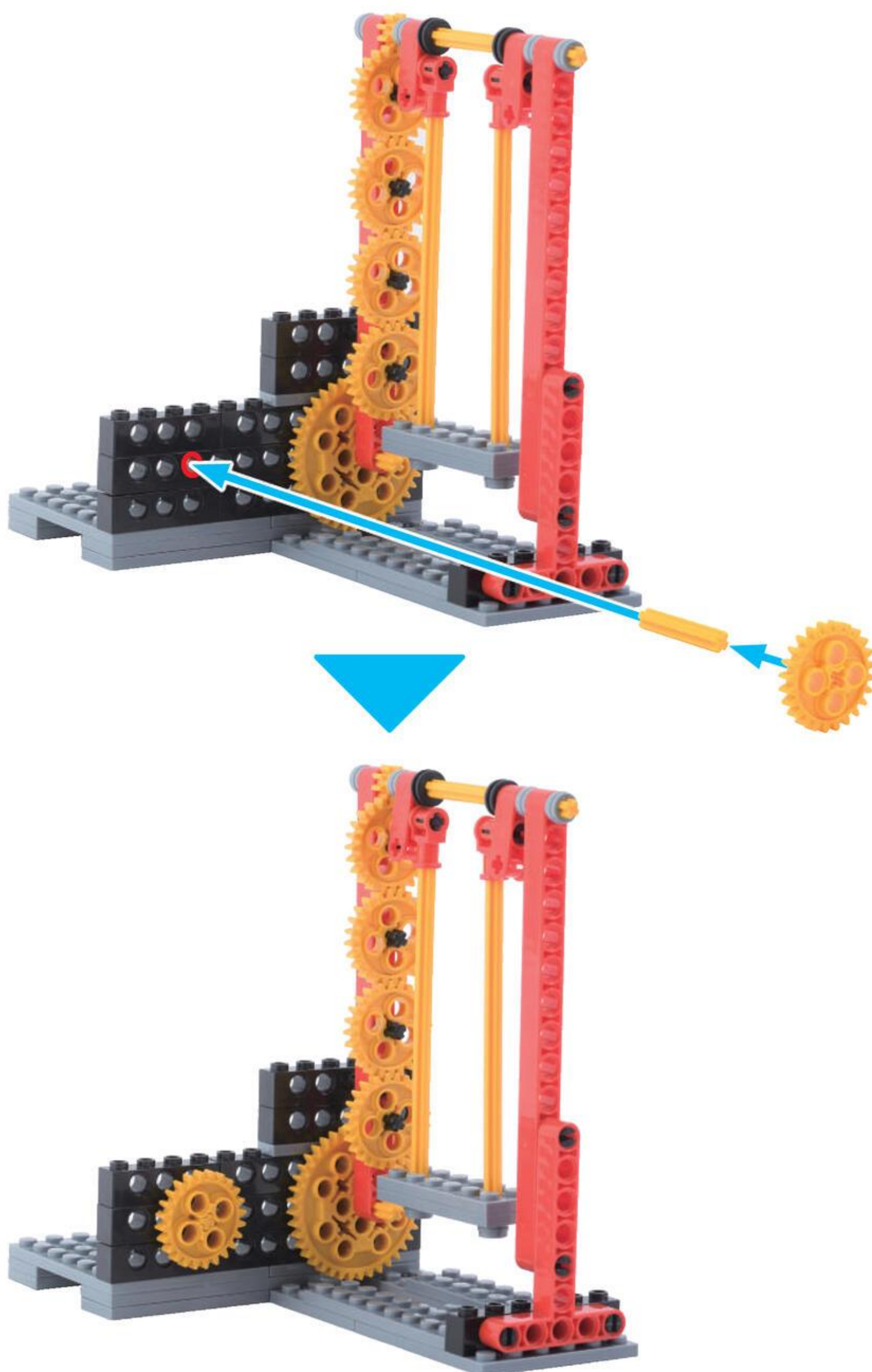



peg 2  
peg S 2

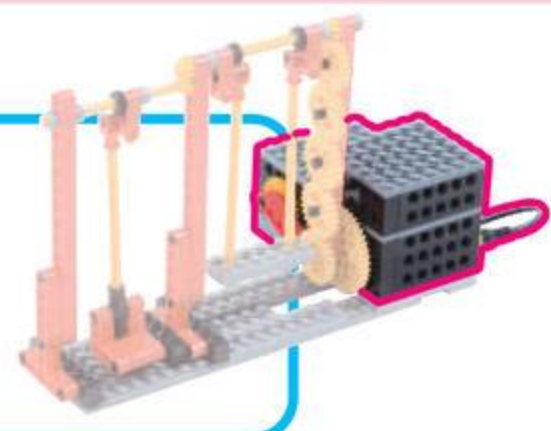

4

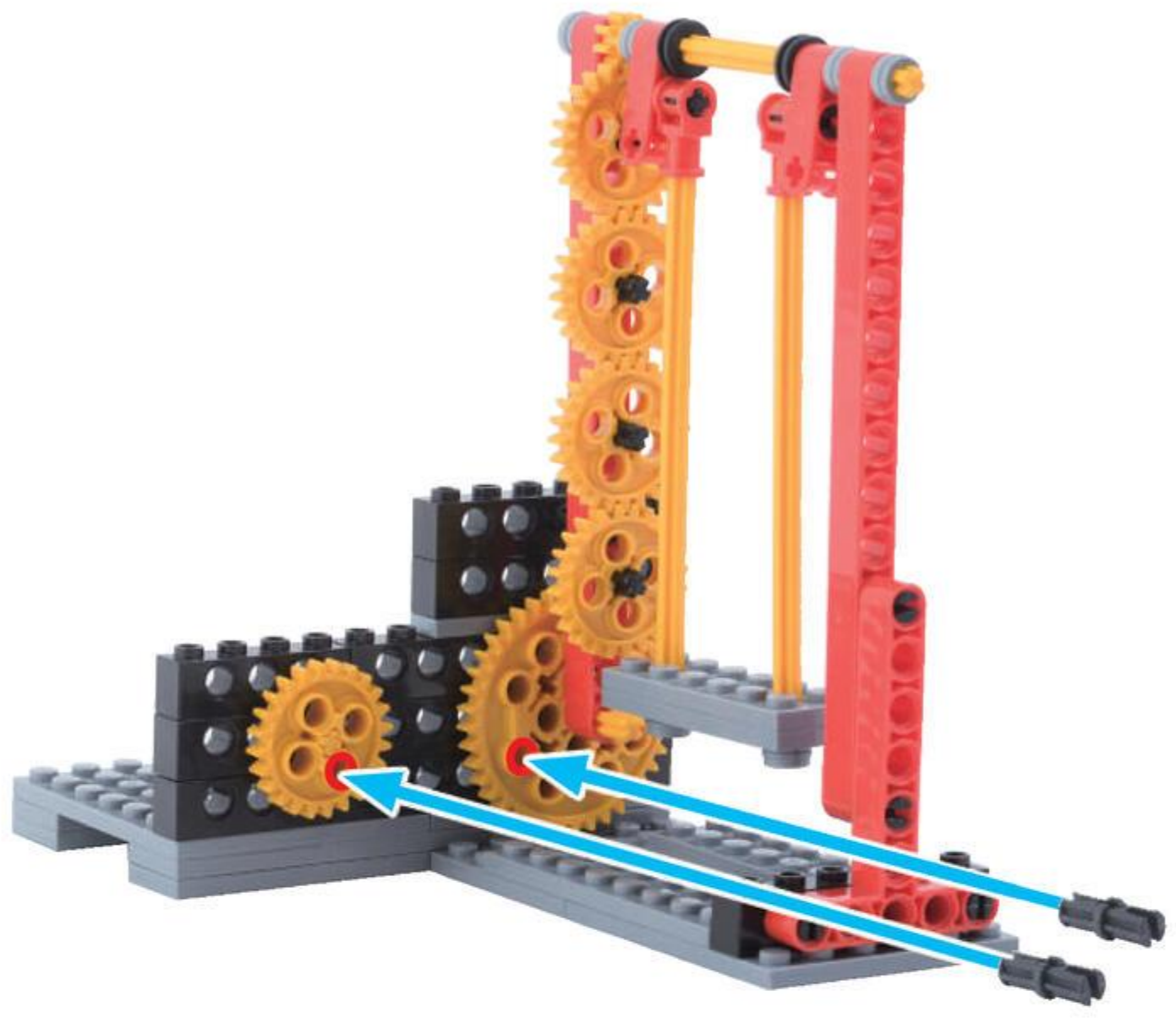



ろっどなあな 1こ  
ロッド7アナ

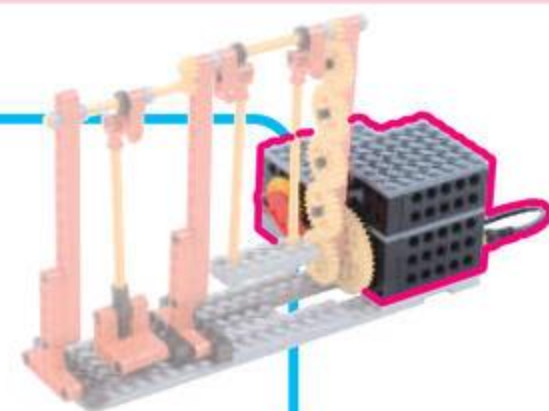

5

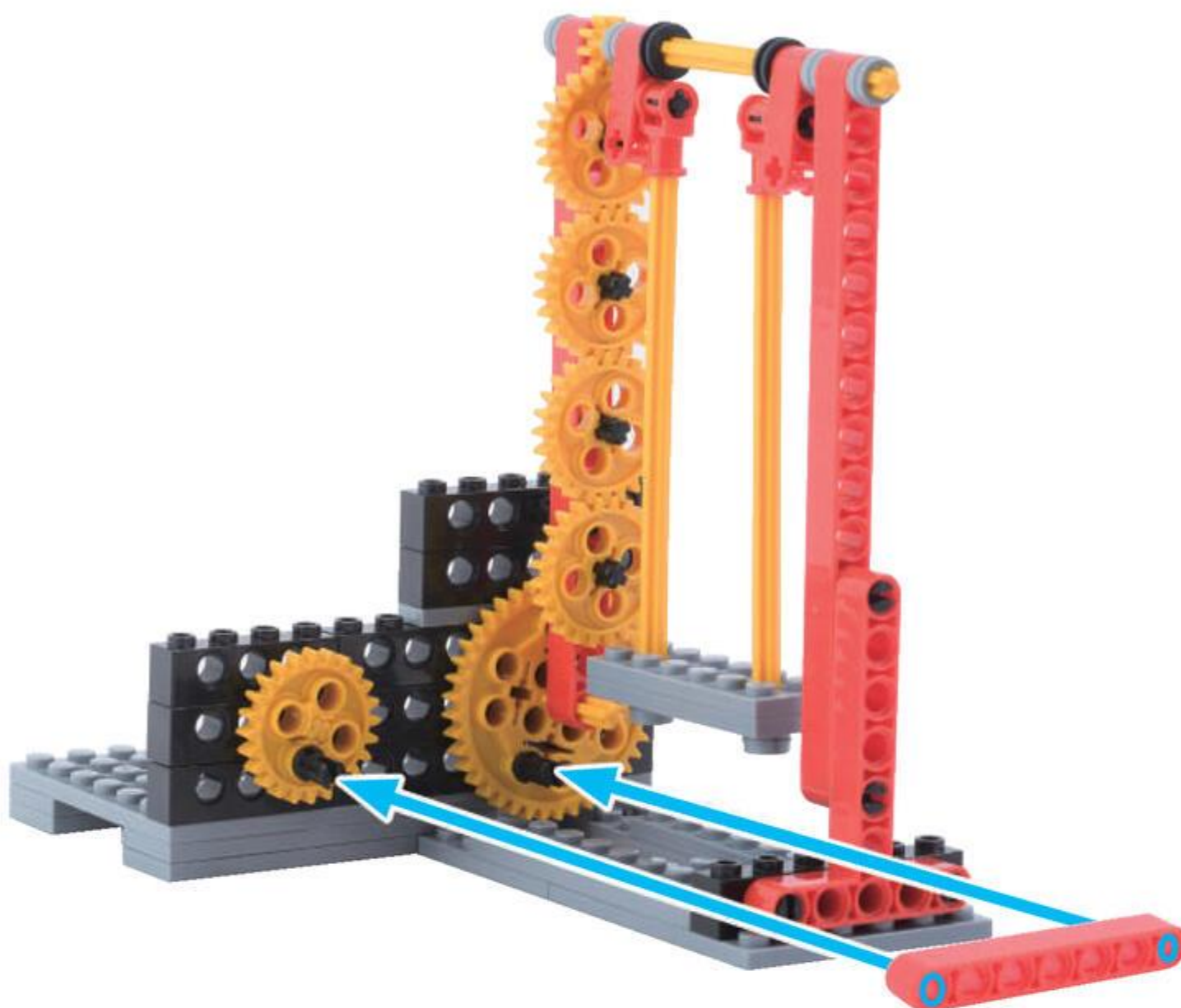

ぎあえむ  
ギアMをうごかして  
さしこめるいちをさがそう

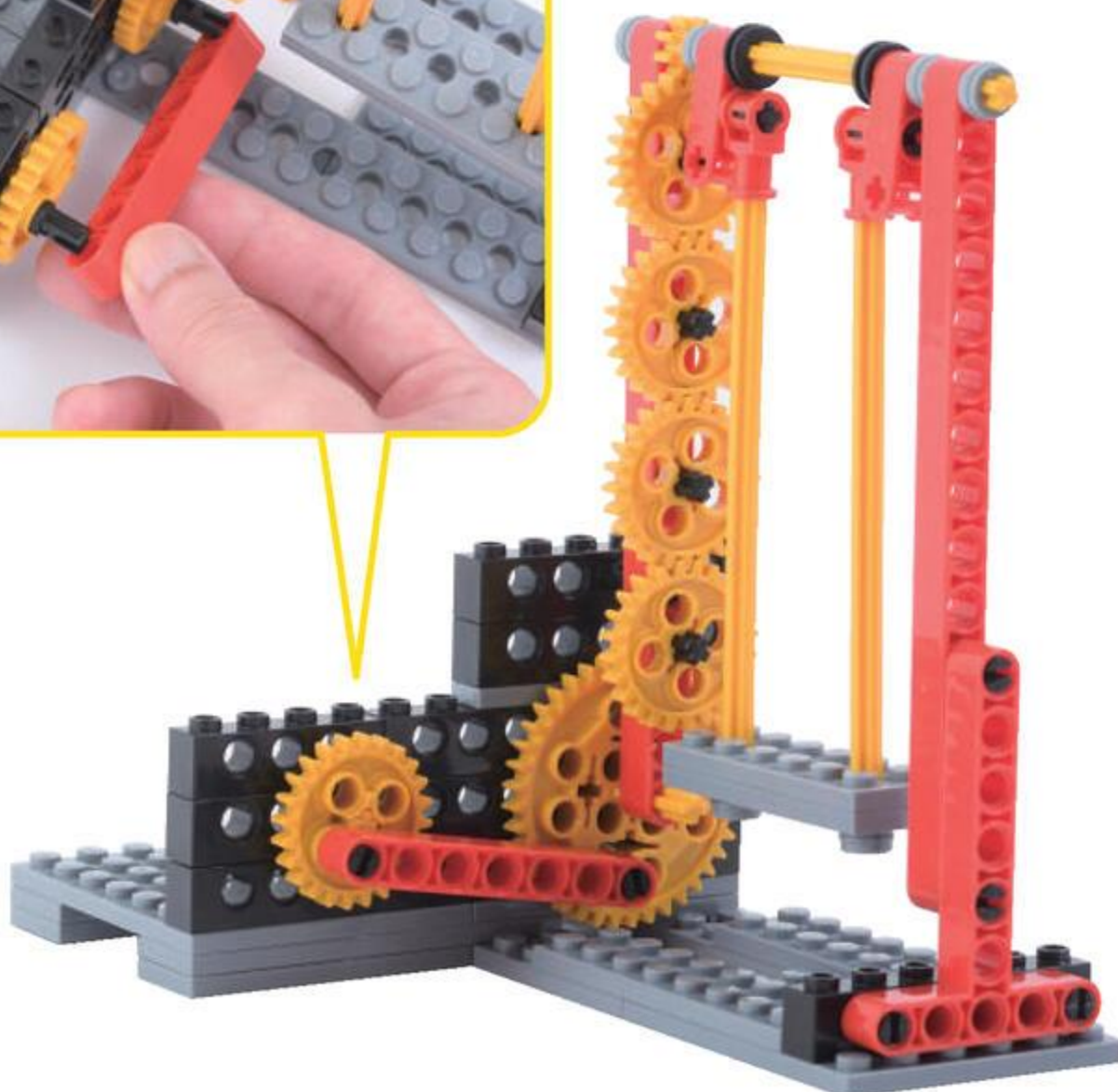
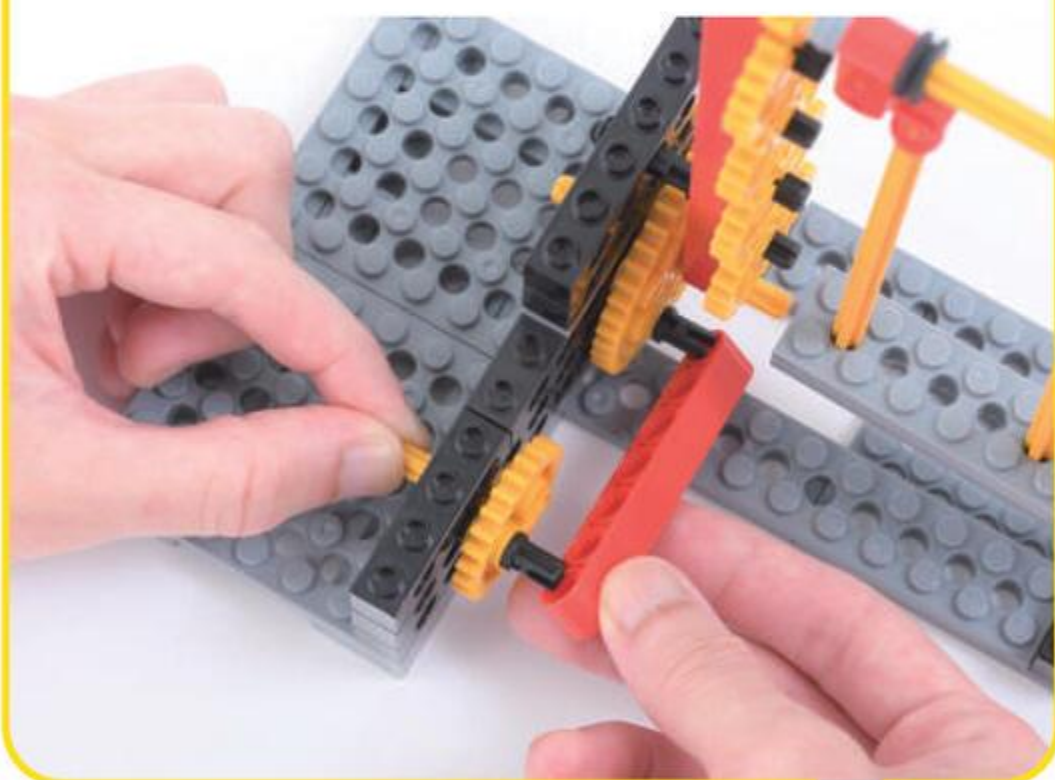



ぎあえむ  
ギアMうす 1こ

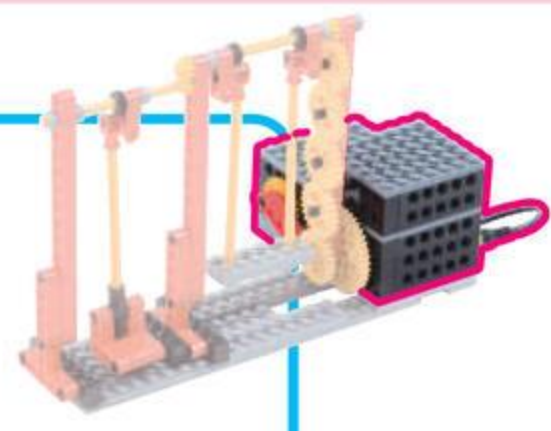
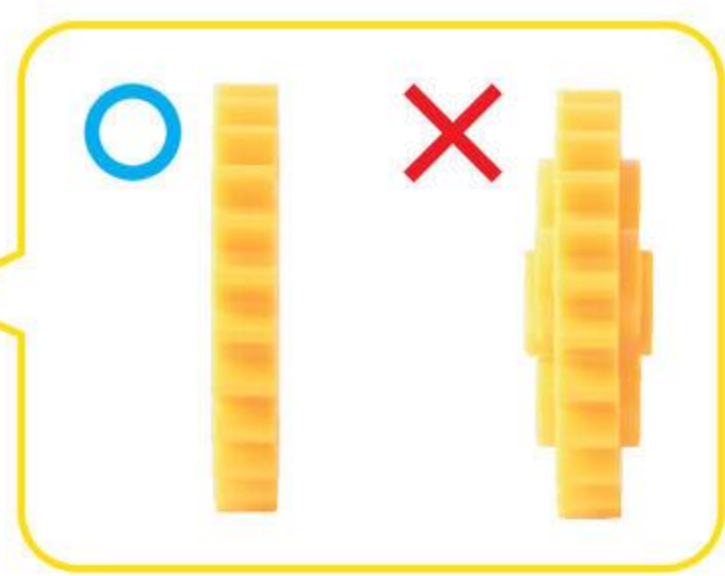
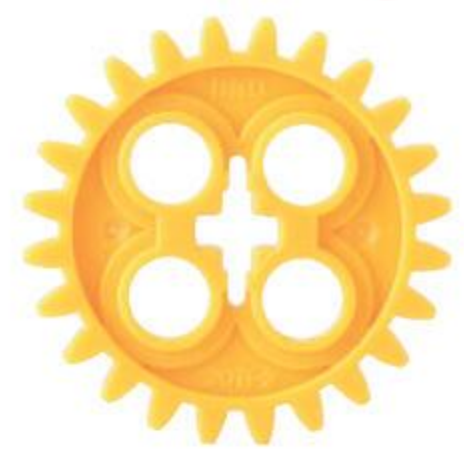

6

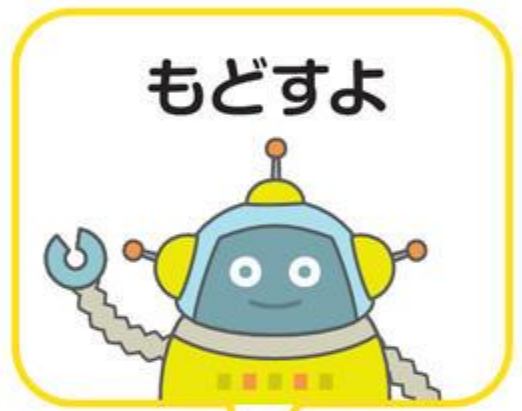



ぎあえむ  
ギア M 1こ

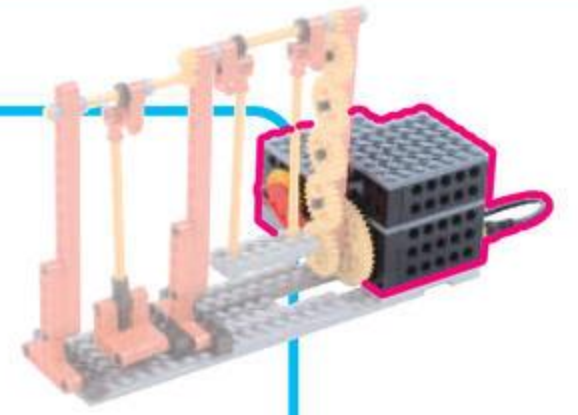

7

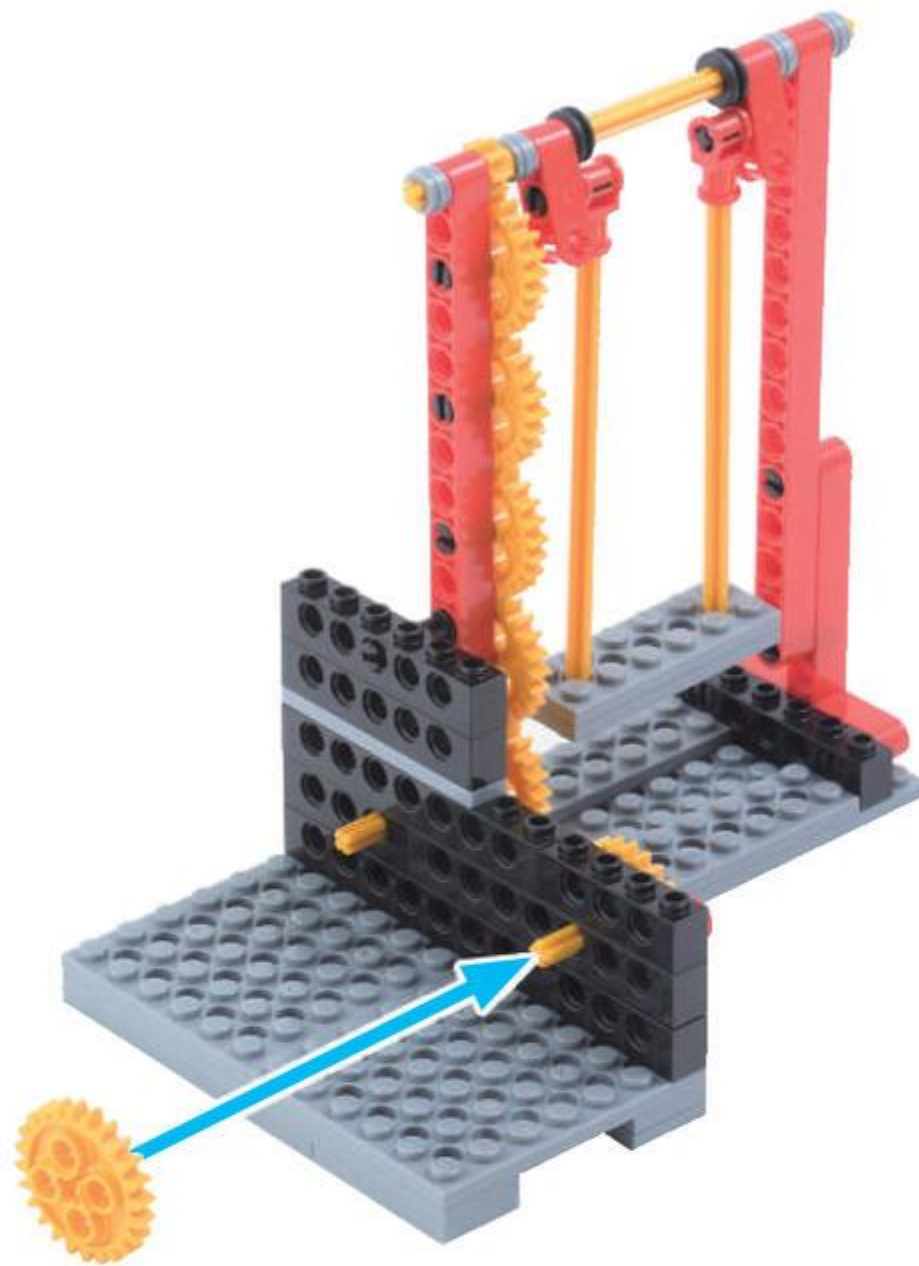



ふとぶれえとろくほち  
太プレート6ポチ 1こ

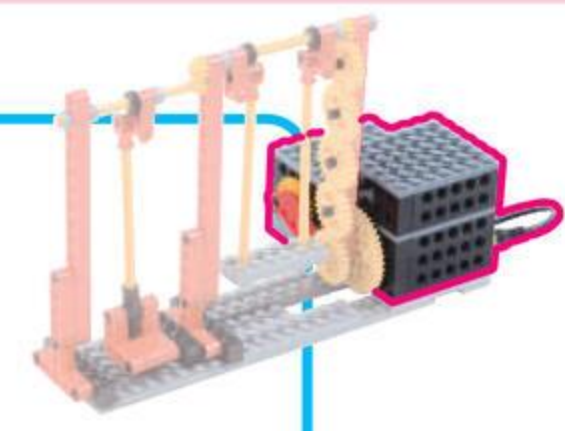

8

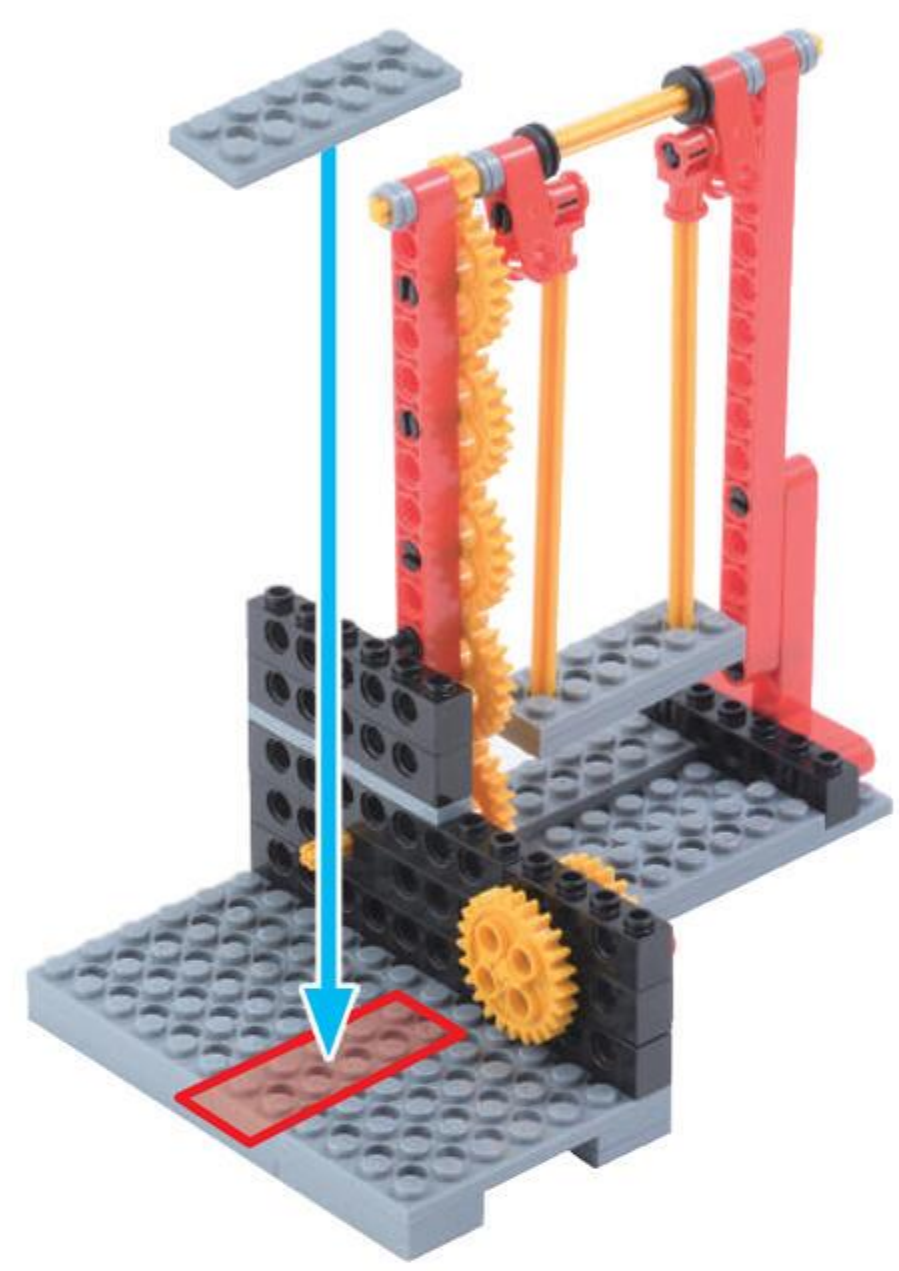

ほち  
1ポチ であるよ

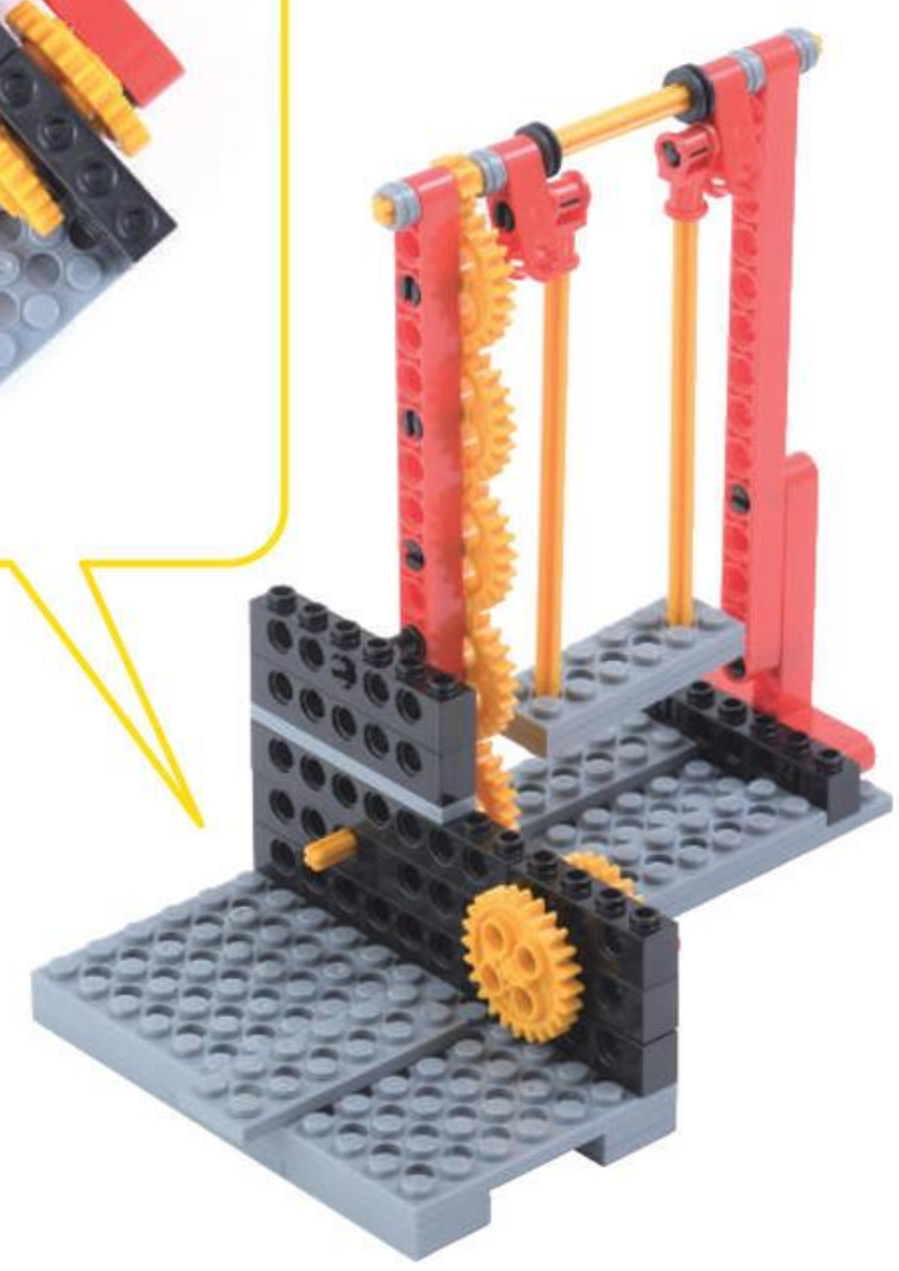



もおたあせつと  
モーターセット 1こ

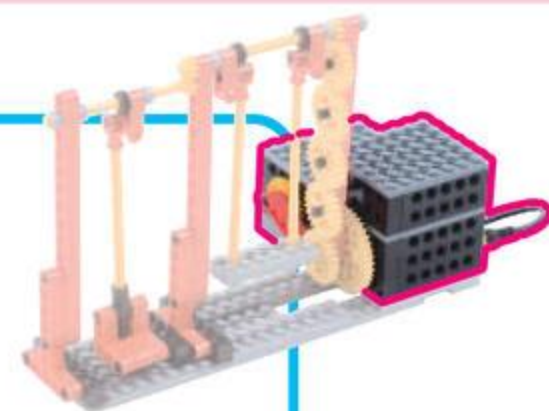
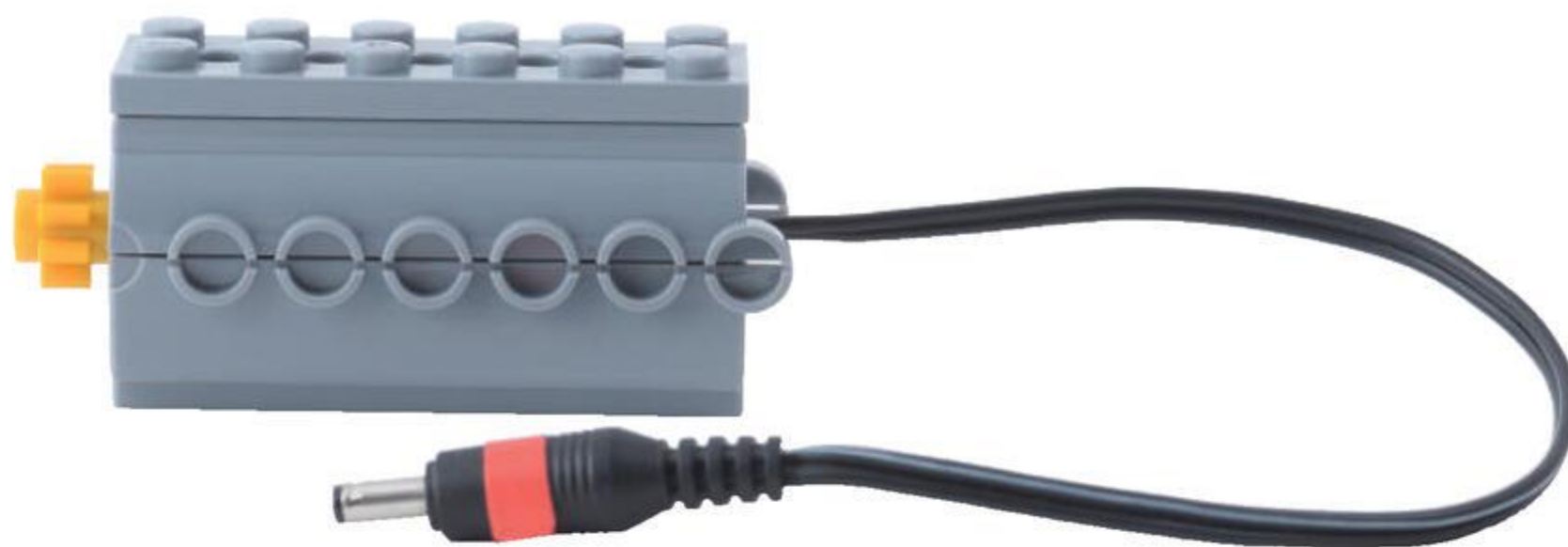

9

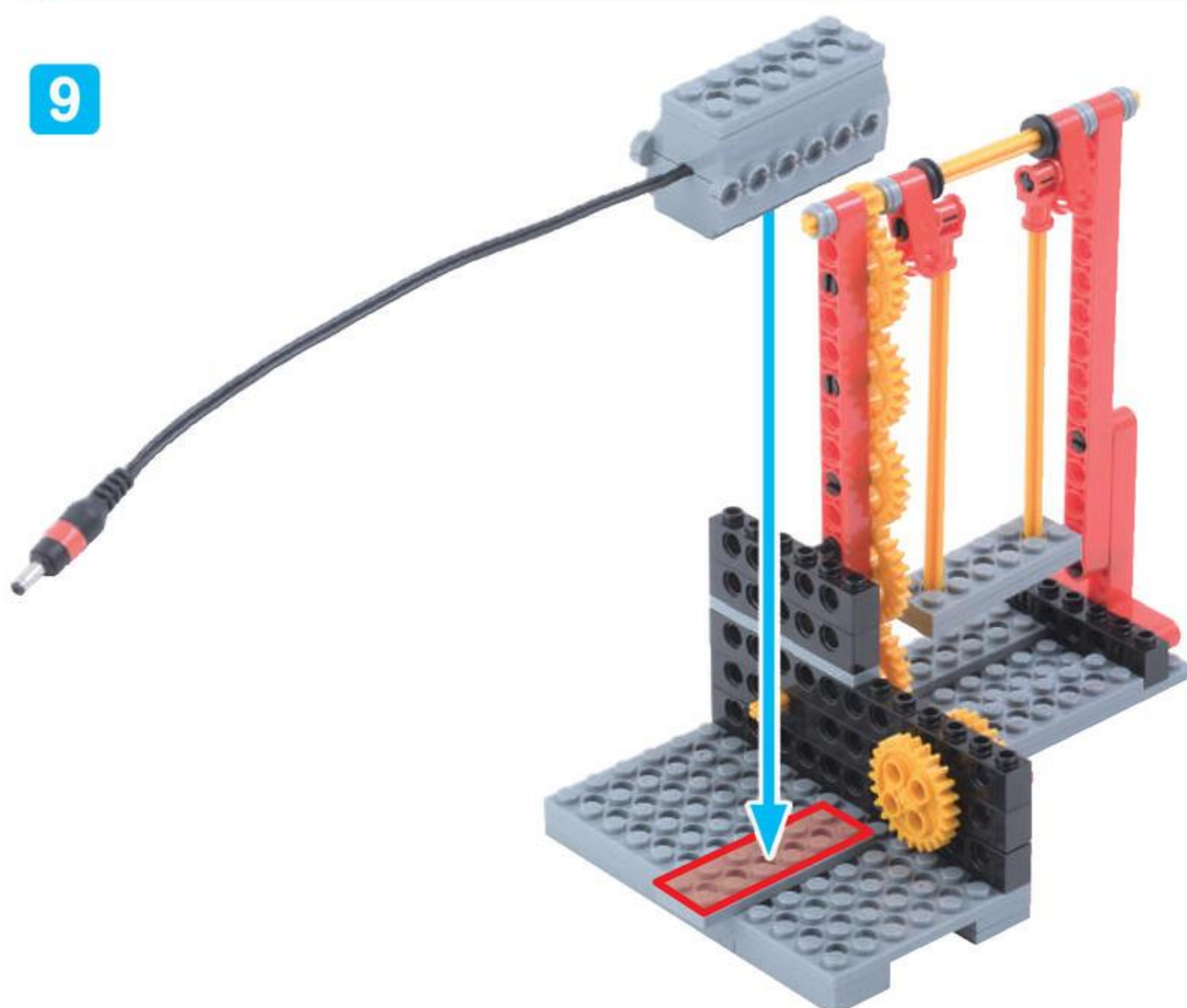

ぎあ  
ギアを  
かみあわせよう





びいむろくぼち  
ビーム 6 ポチ **8** こ



ほそぶれえとろくぼち  
細プレート 6 ポチ **1** こ

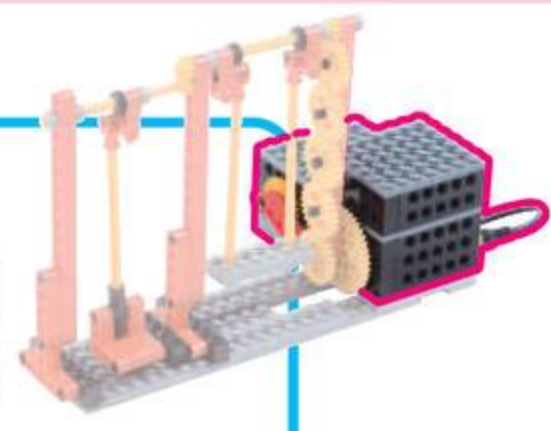

**10**

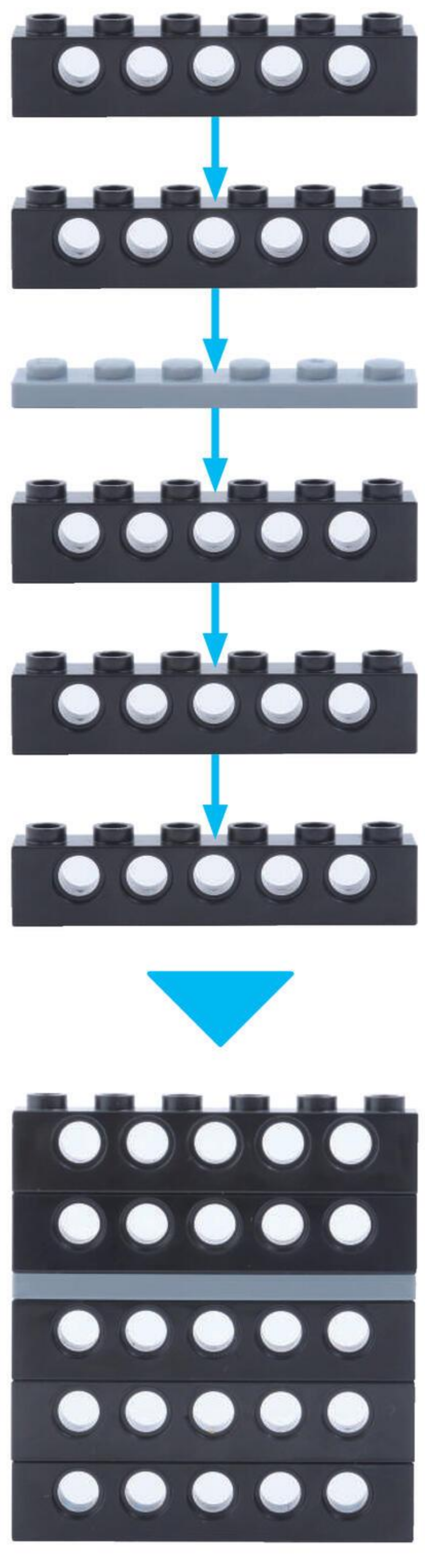
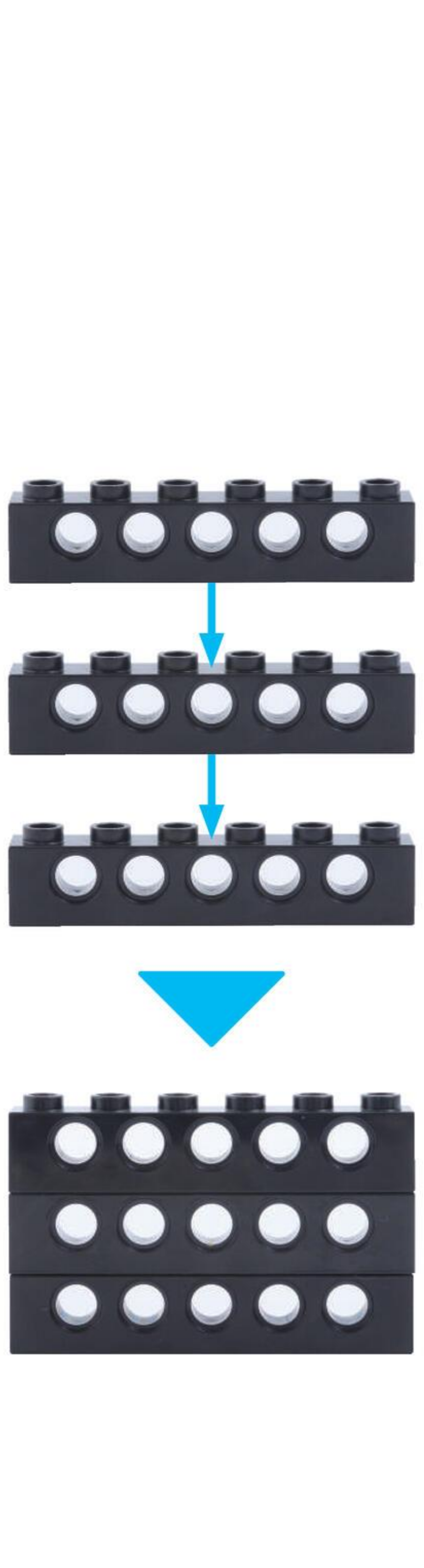



11

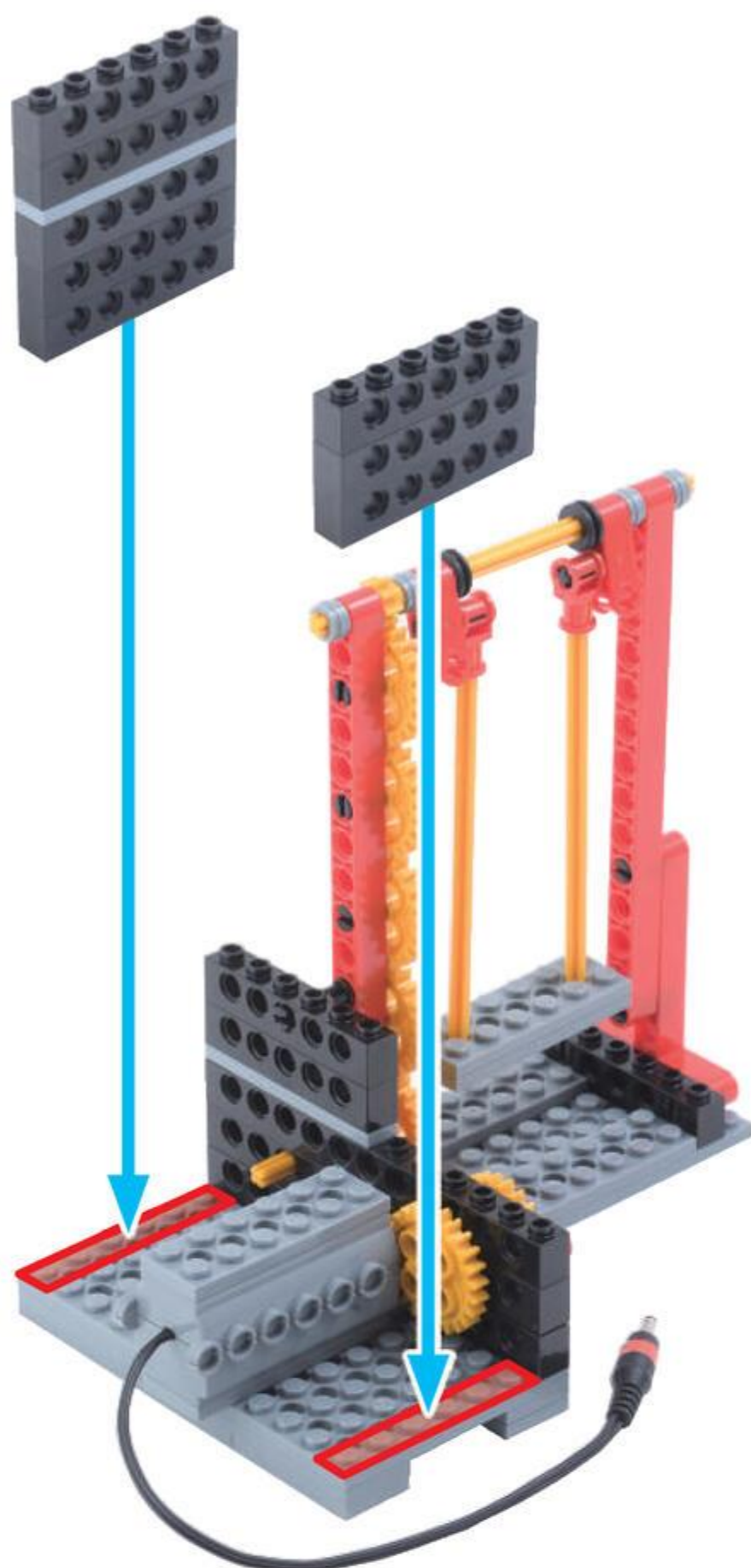
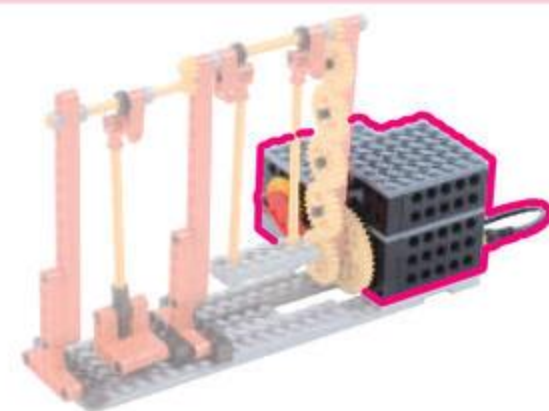



ばってりいぼっくす / すらいどすいっち **1**こ

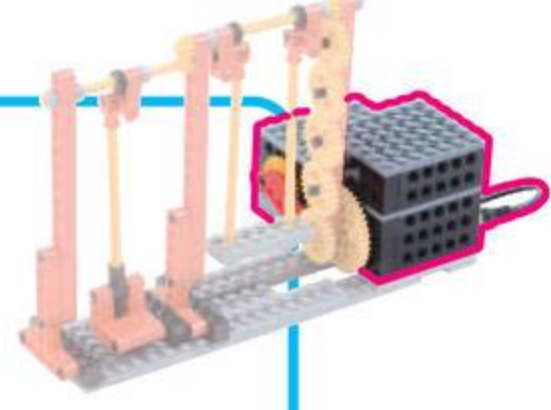

たっちせんさあくろ **1**こ



**12**

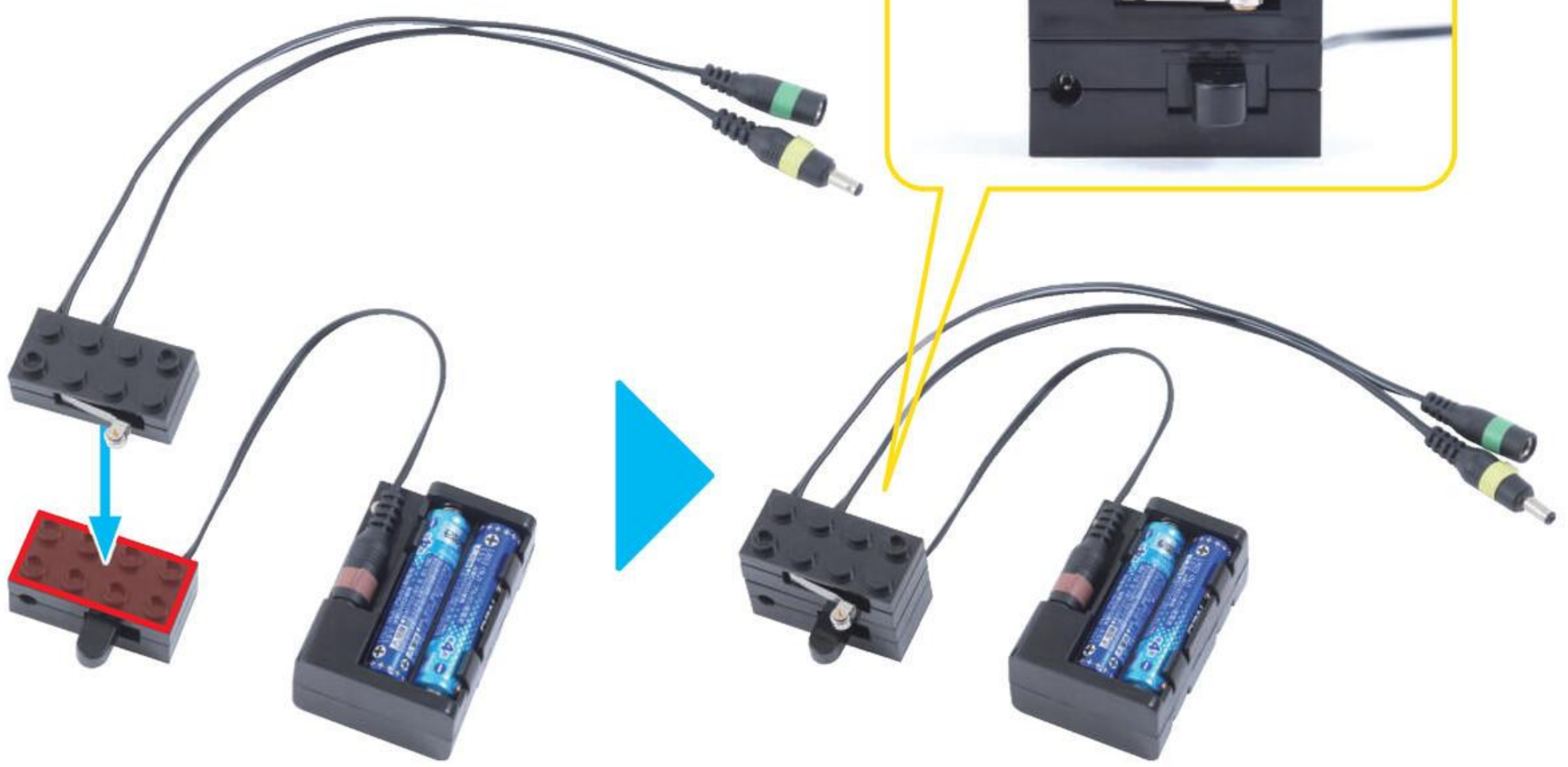



13

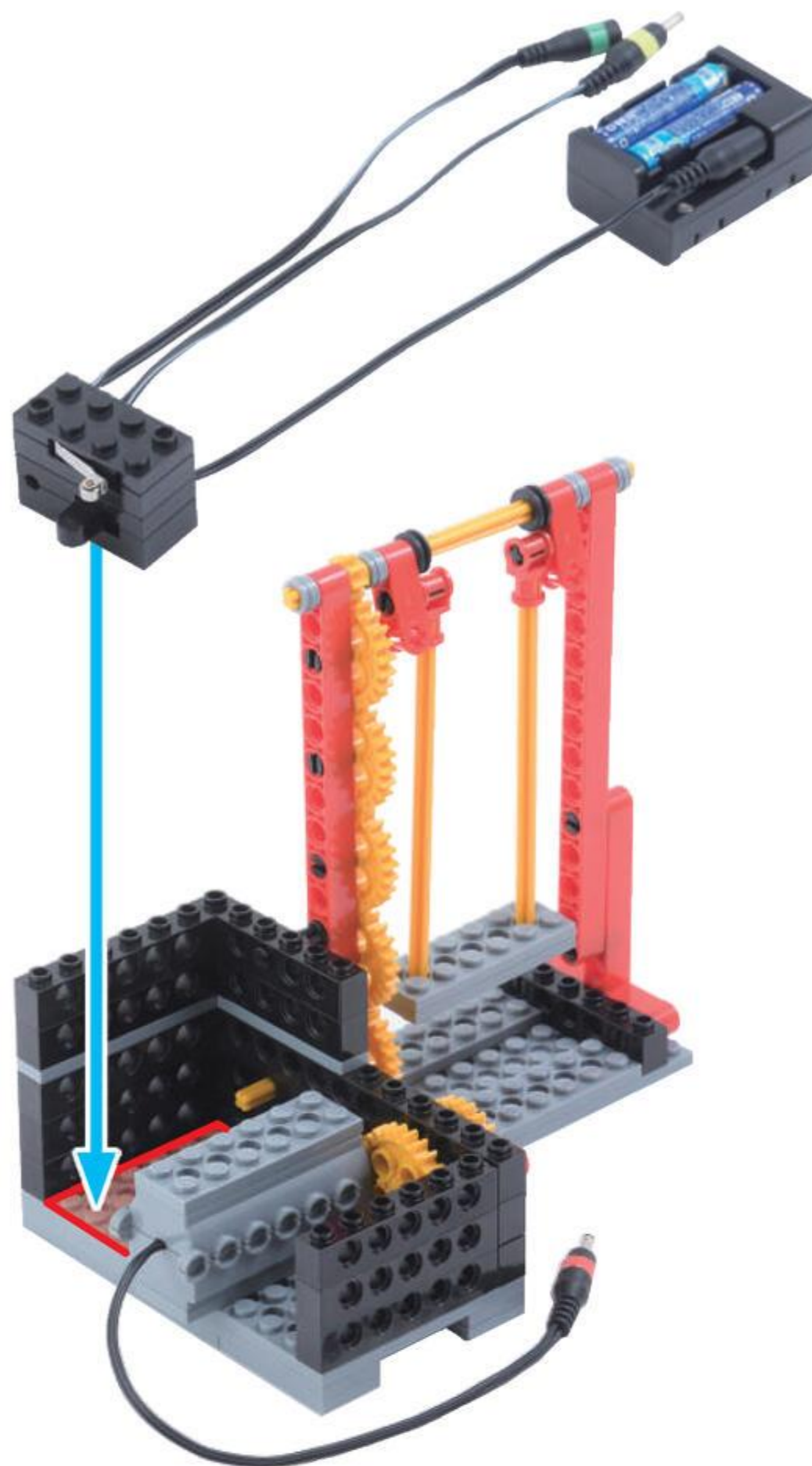
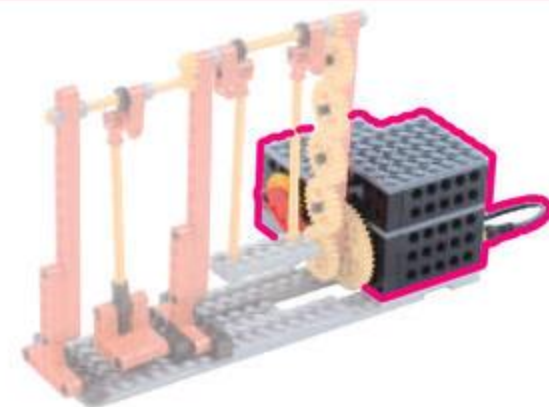

ばってりいほっくす  
バッテリーボックスは  
おくだけだよ

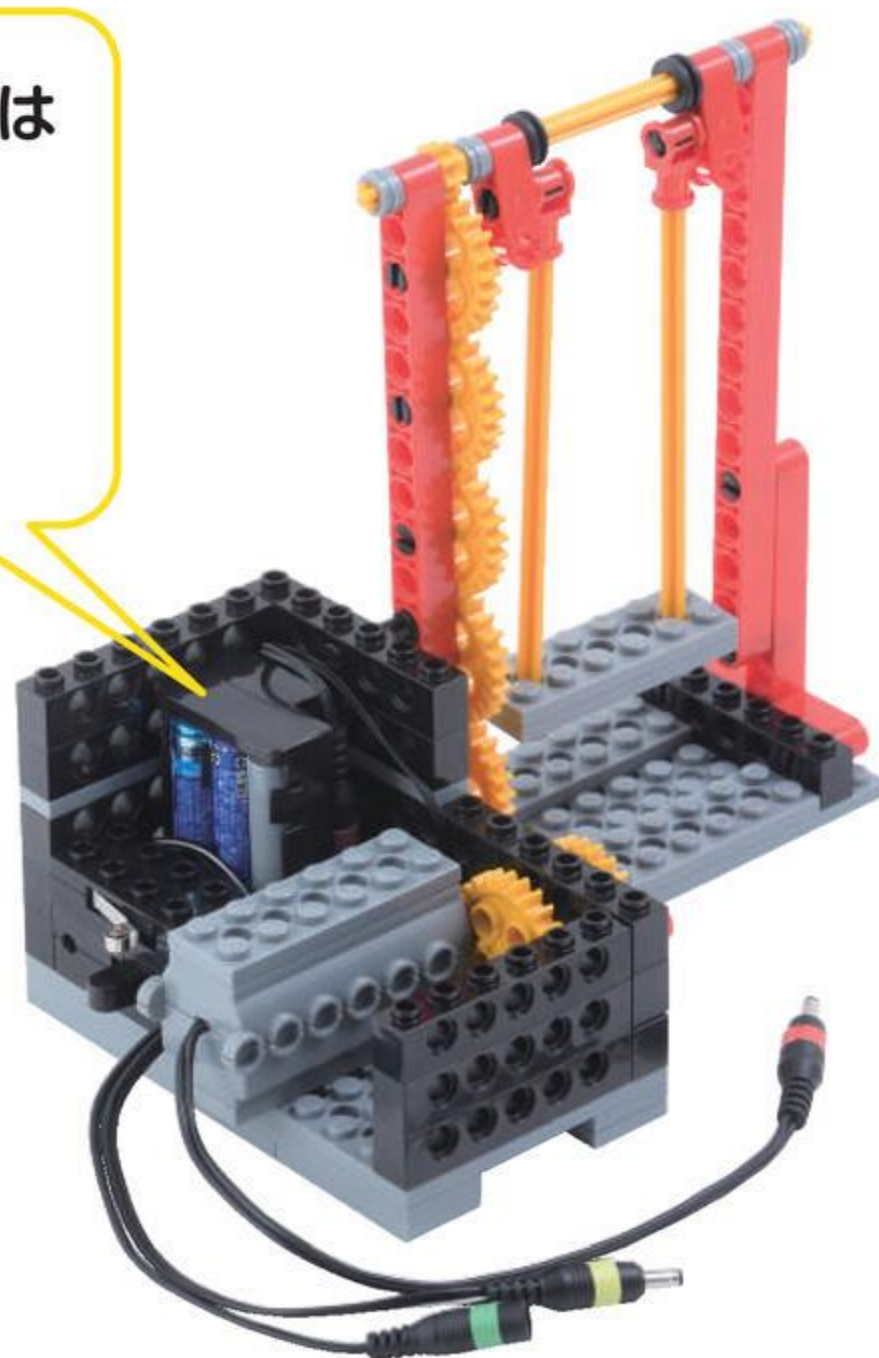
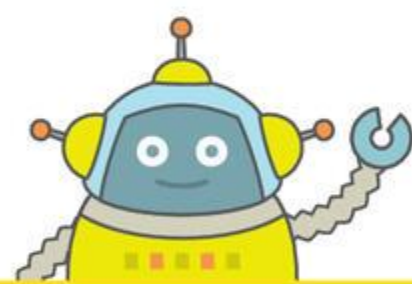



びいむよんほち  
ビーム 4 ポチ 3 こ

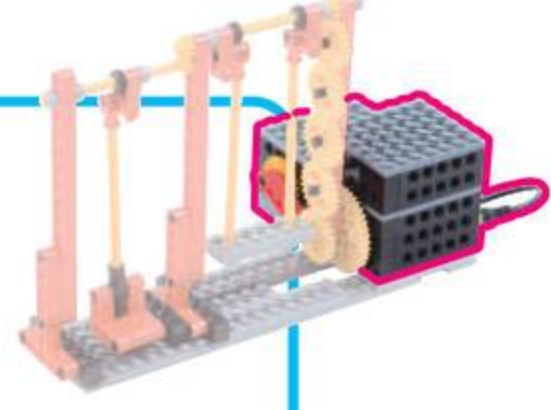

14





15

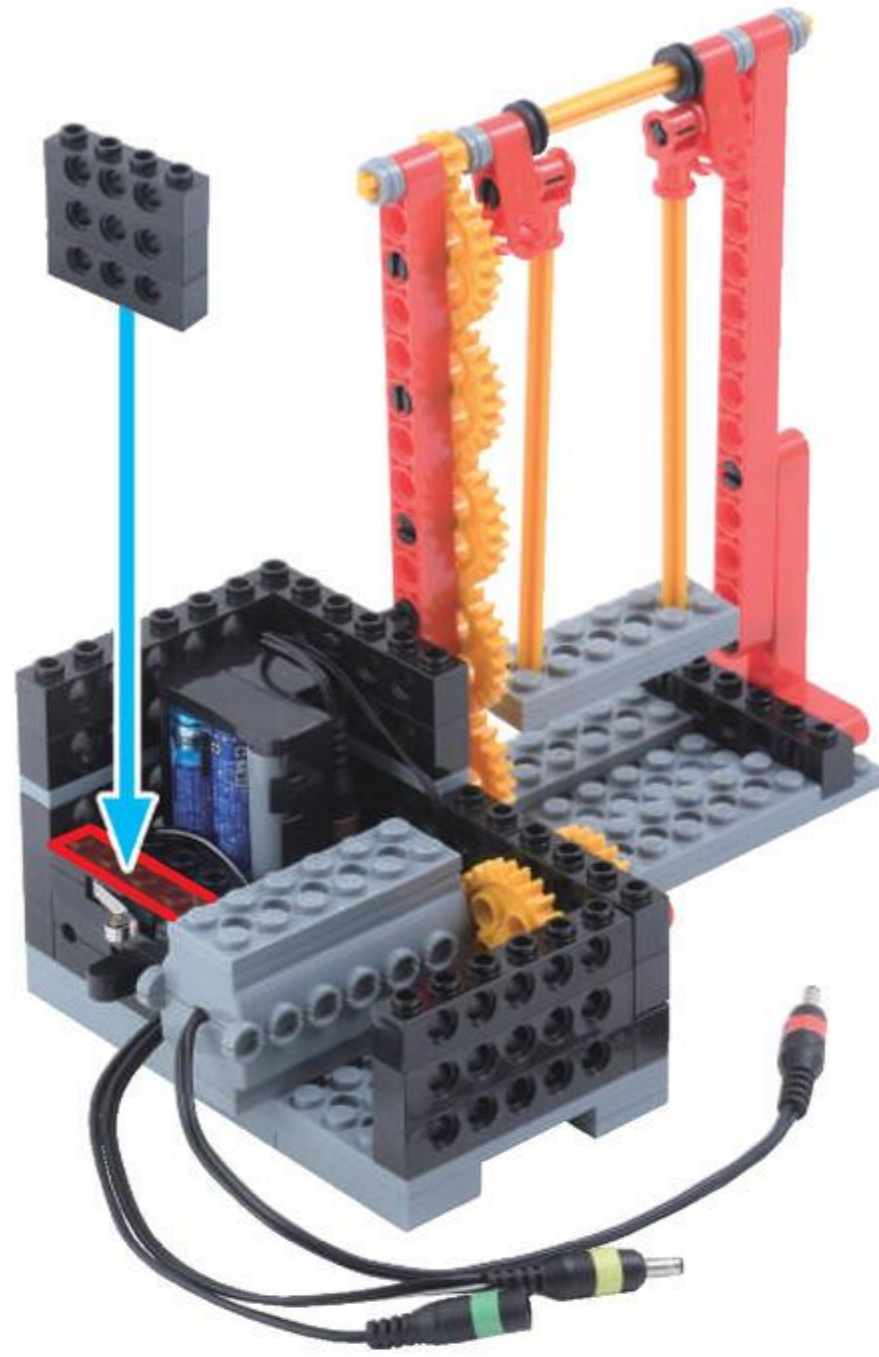
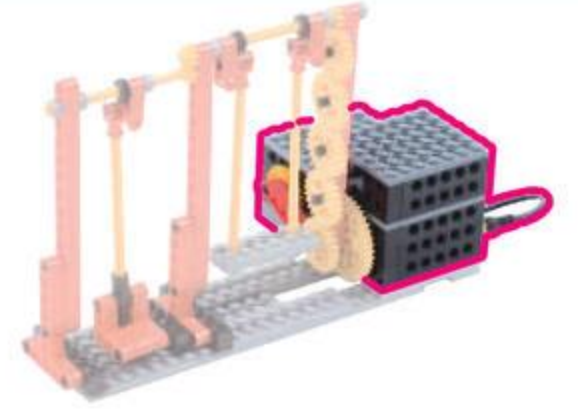



16

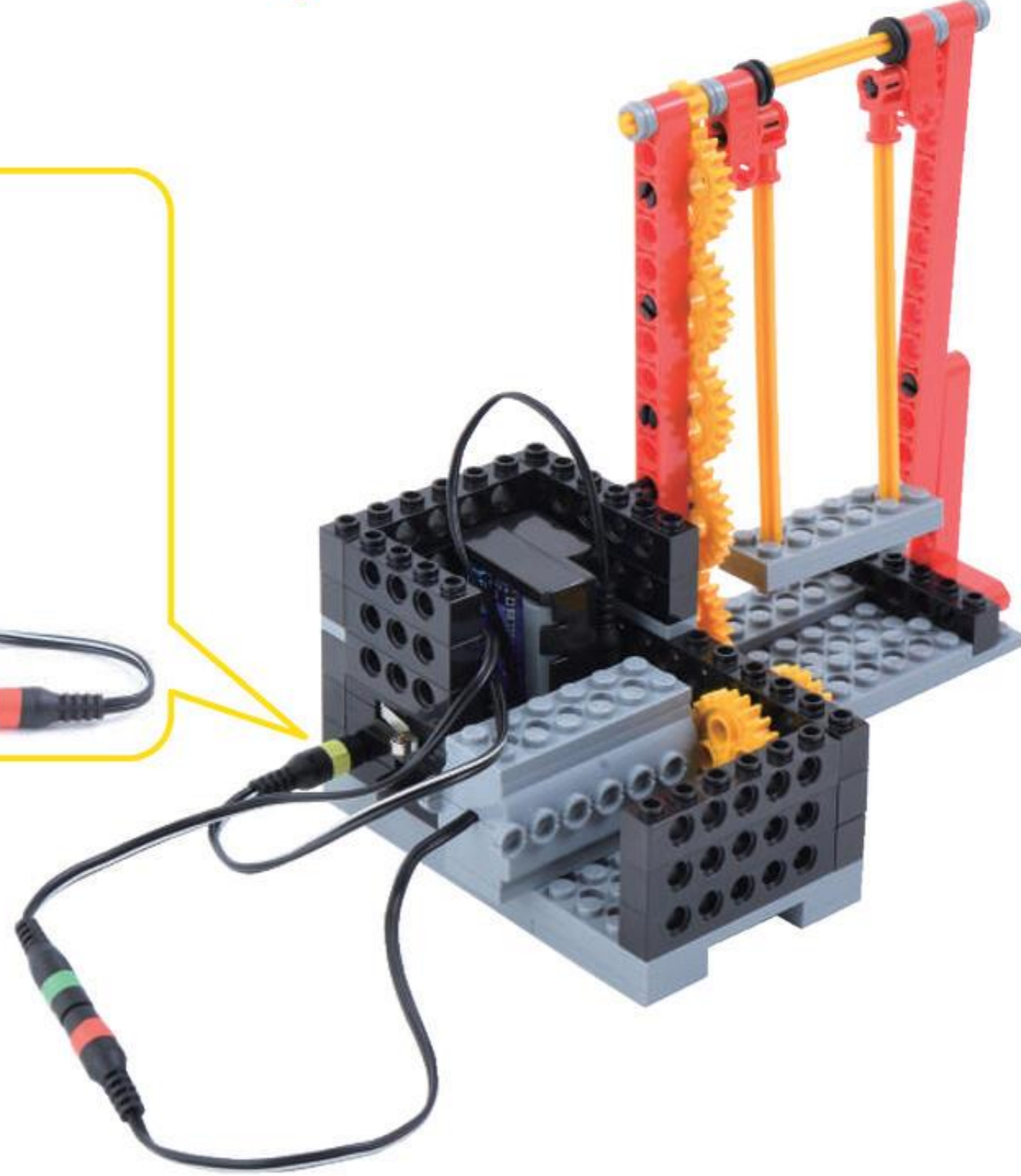
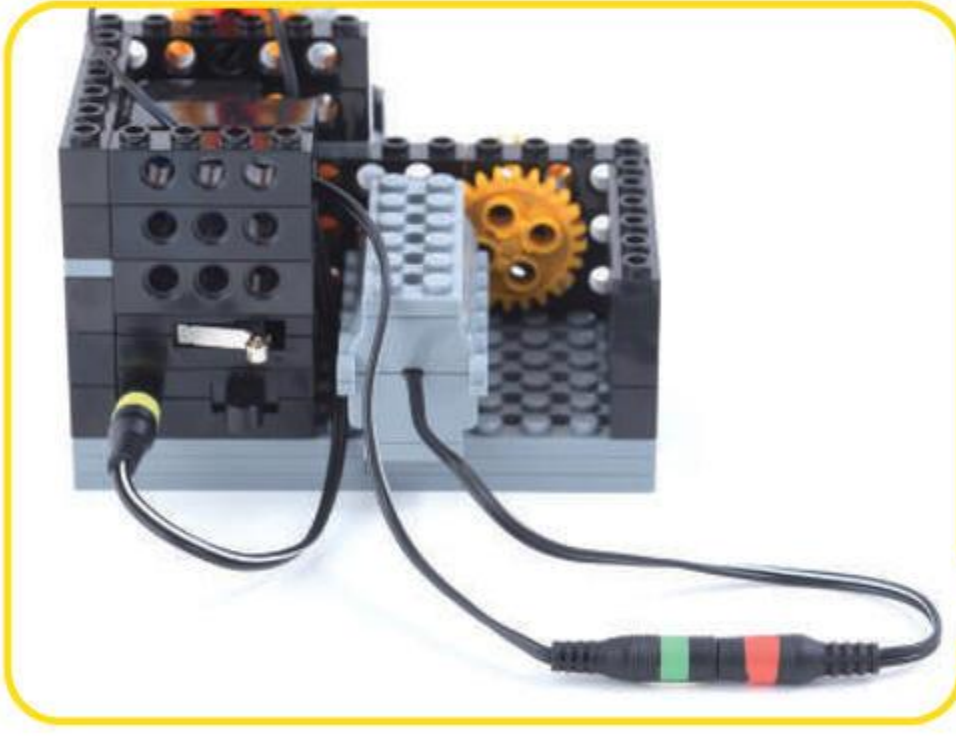
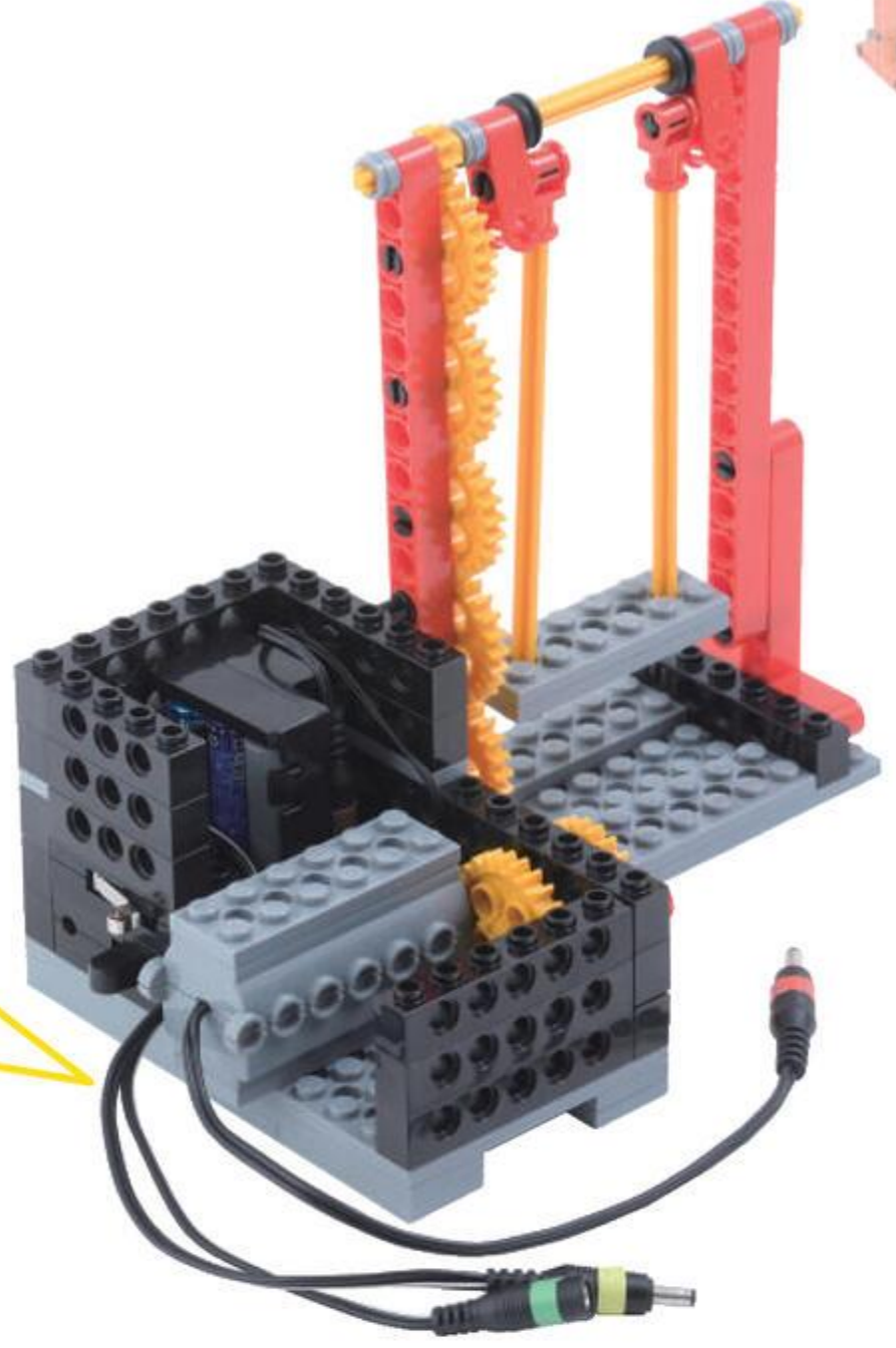
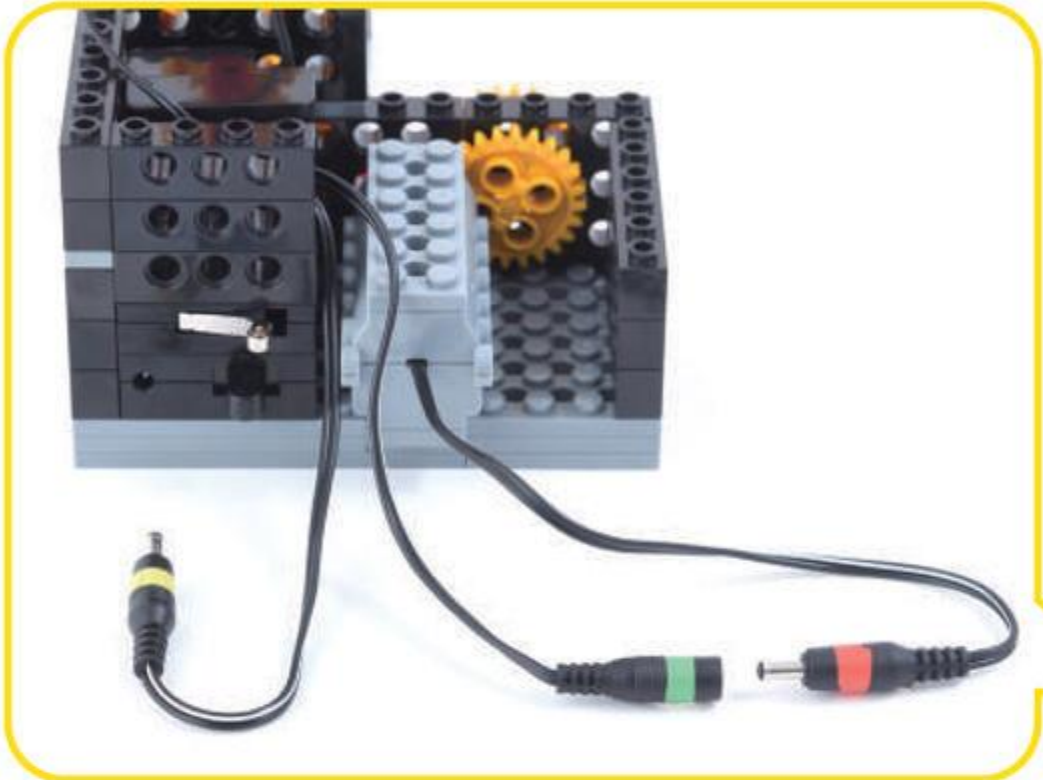
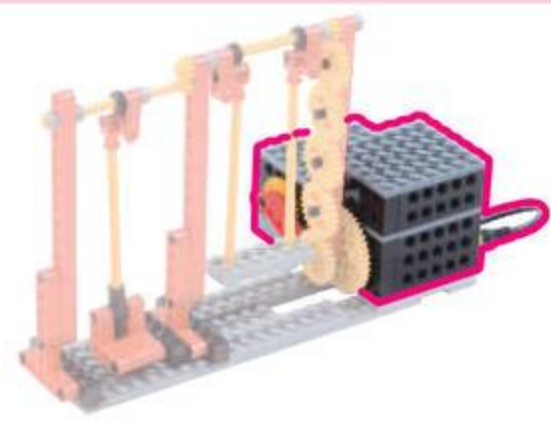

コードを  
ただしく  
つなごう

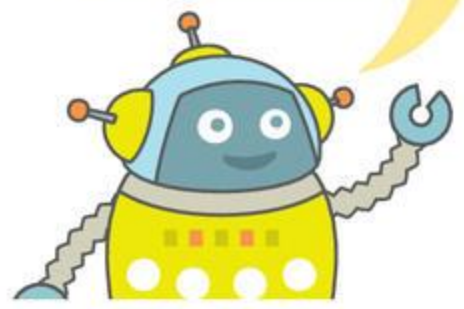



17

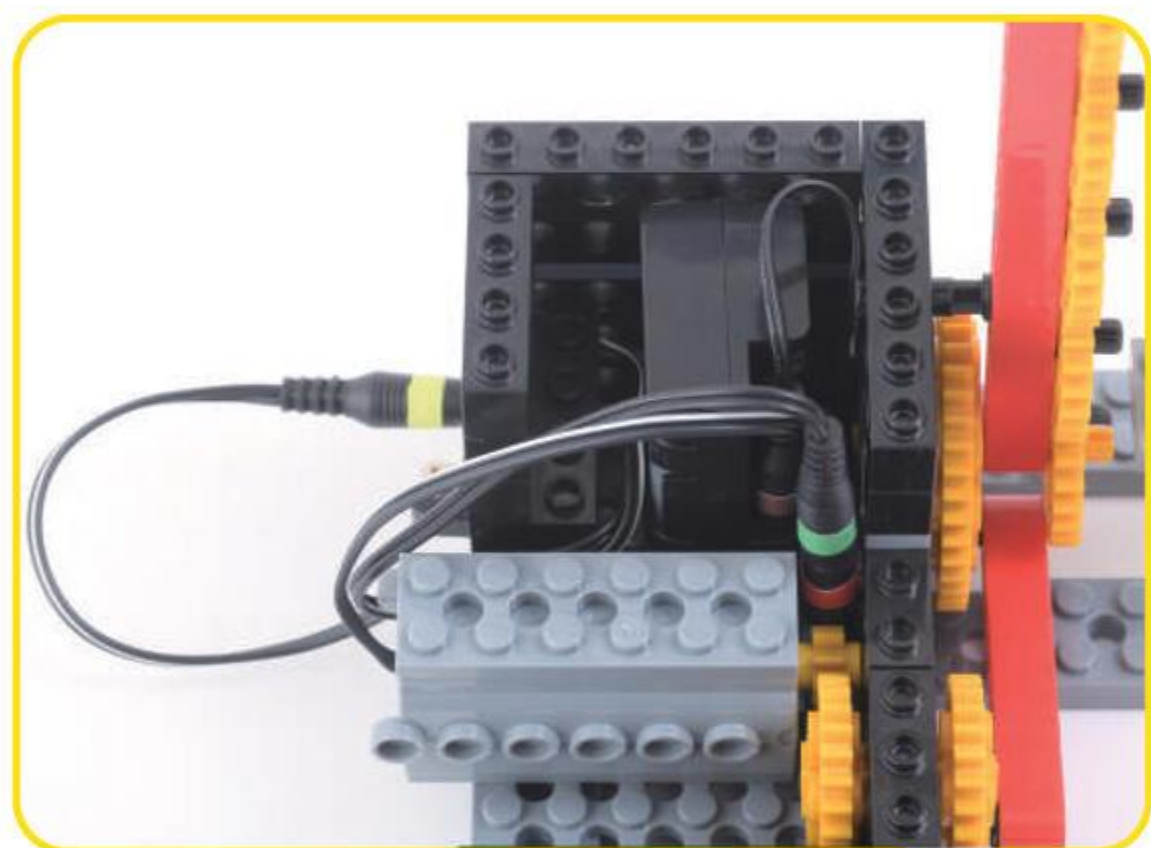
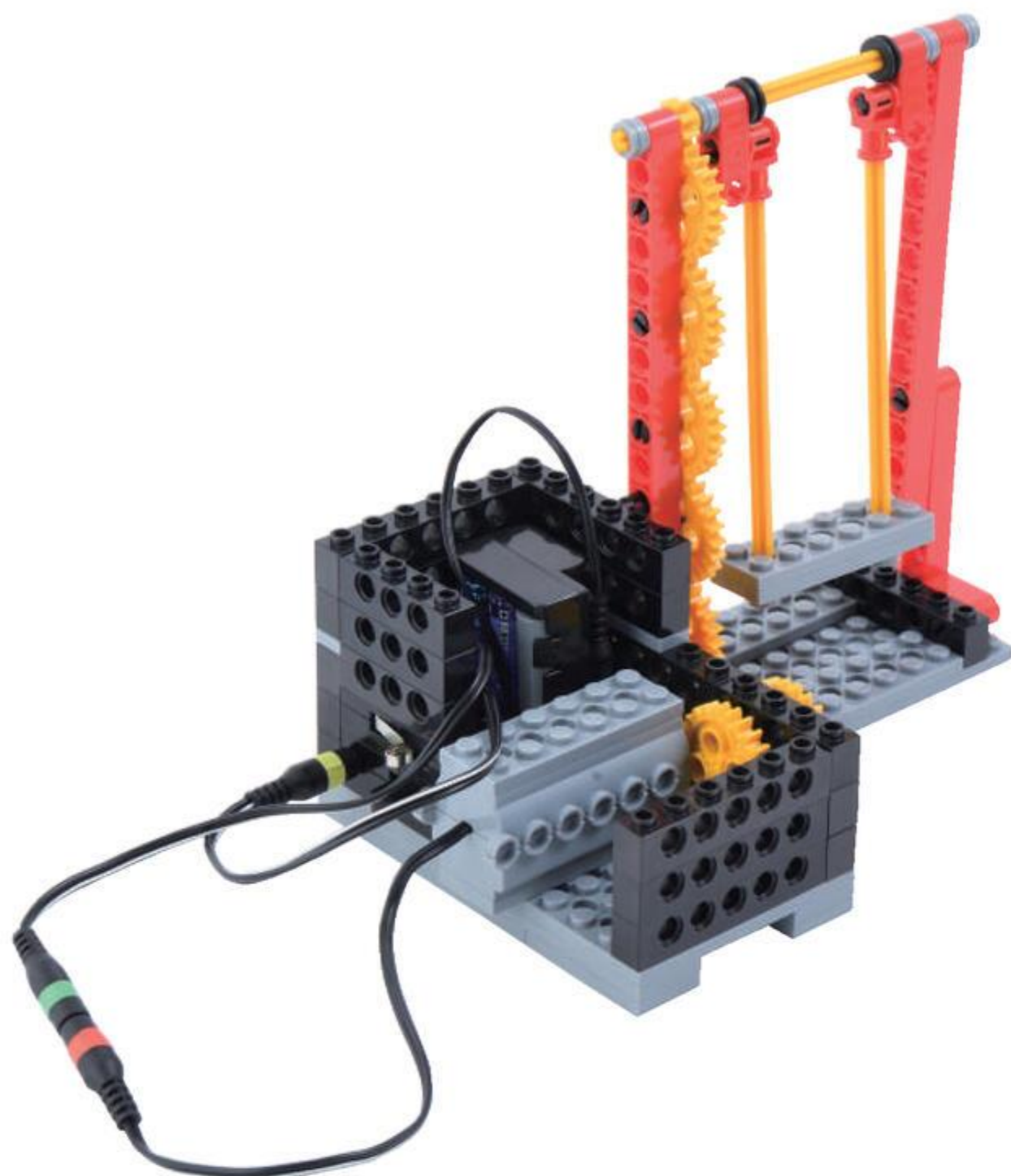
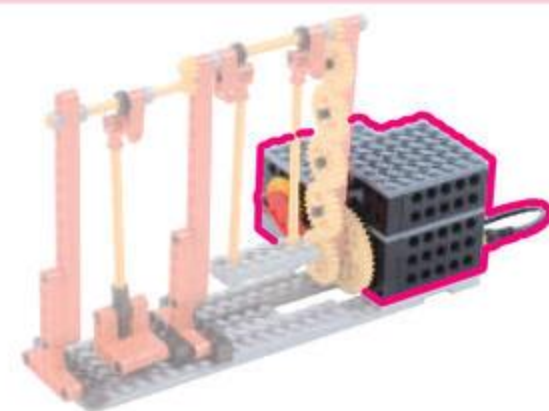

こおど  
コードを たたんで  
いれよう

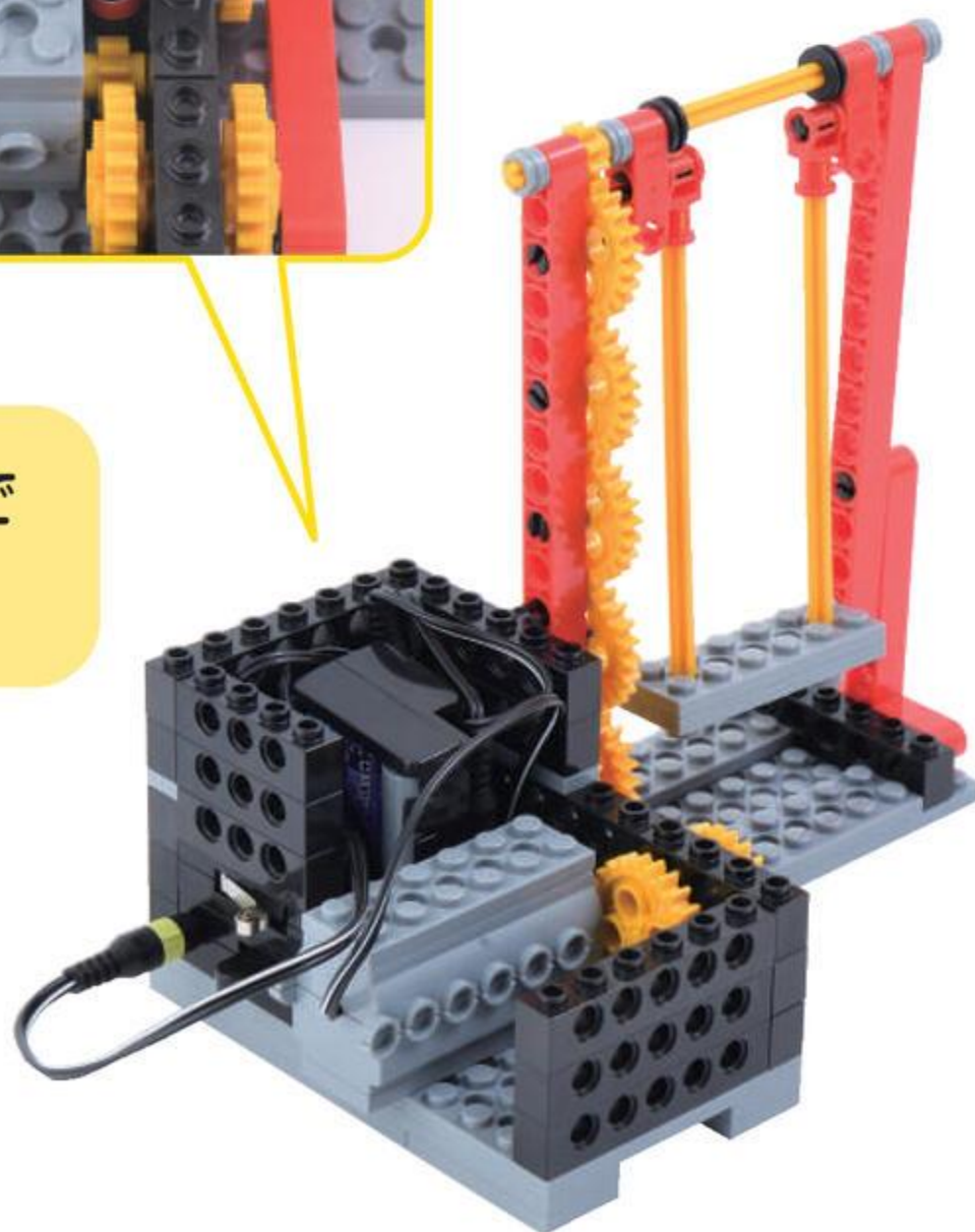
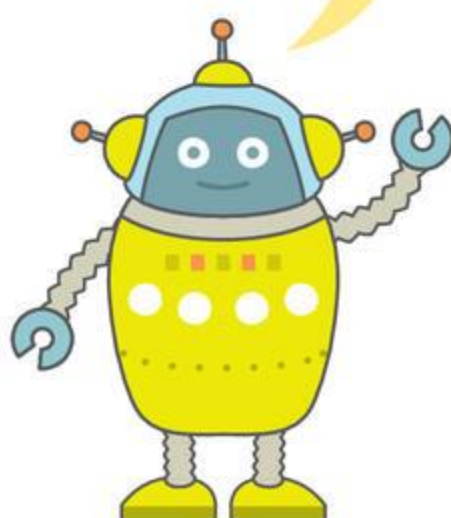



ぶれえとえろ  
プレート **2**こ

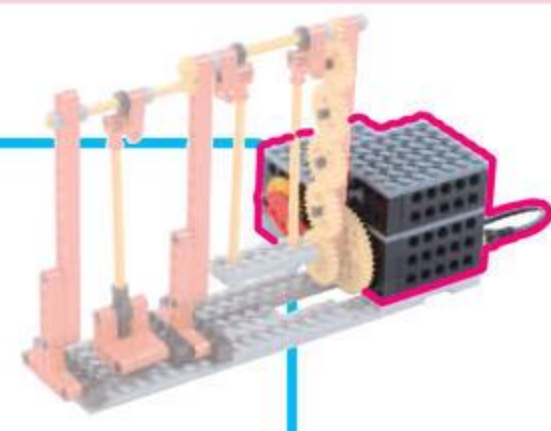
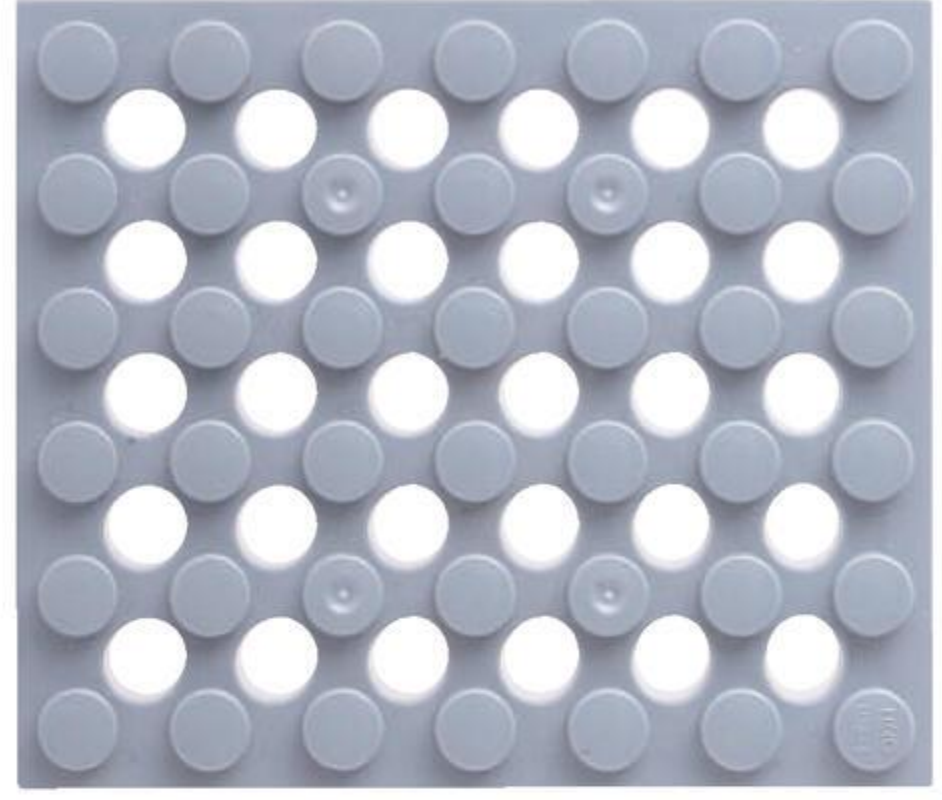

**18**

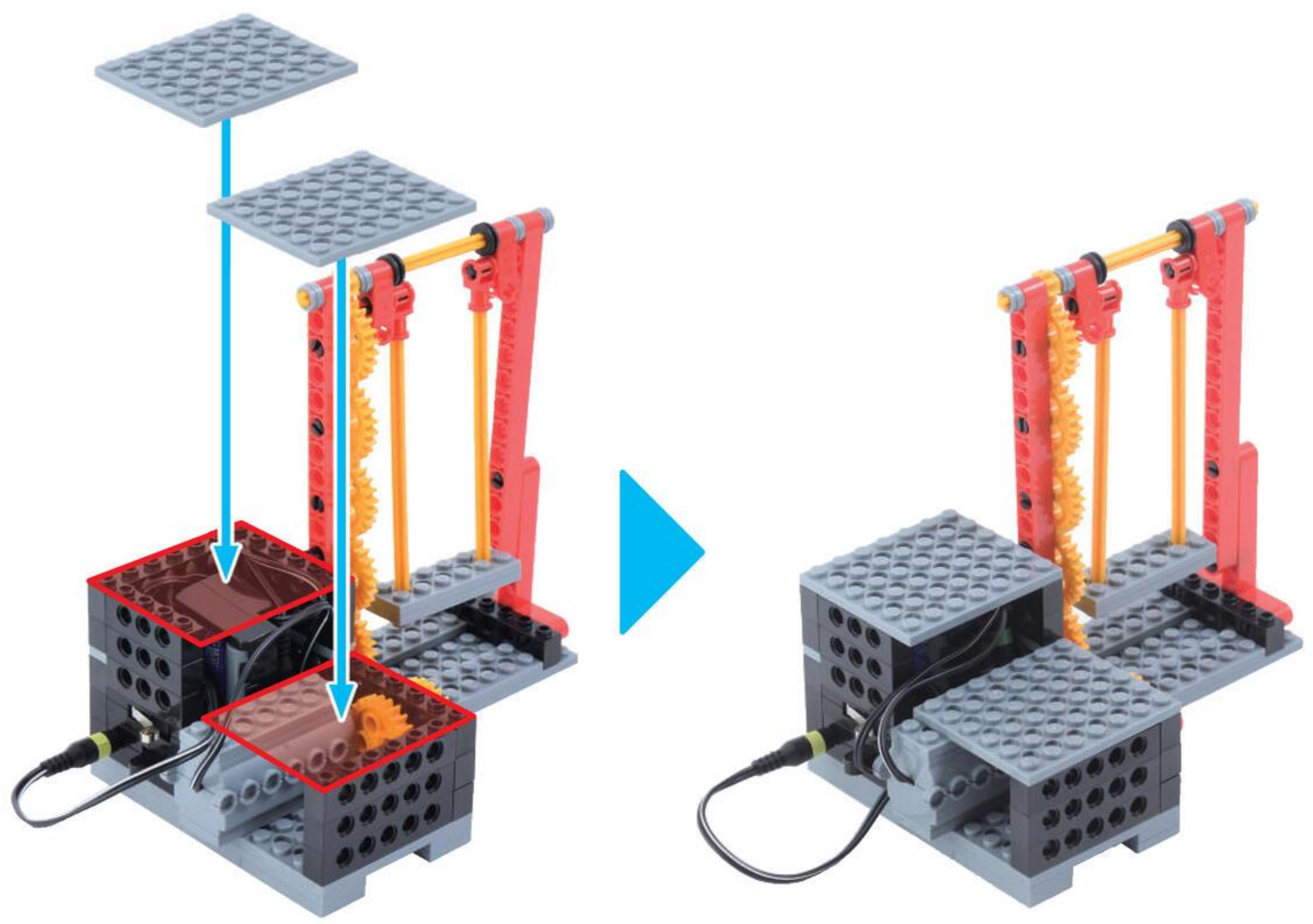

ぎあほくす  
ギアボックスが  
かんせい!

やったね!

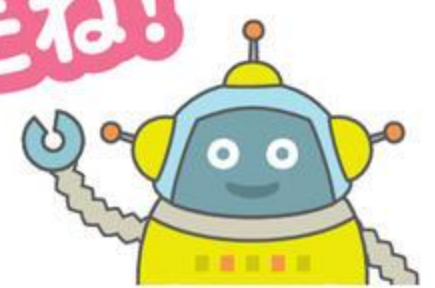



ろぼっと  
ロボットをうごかそう

めやす 5 ぶん

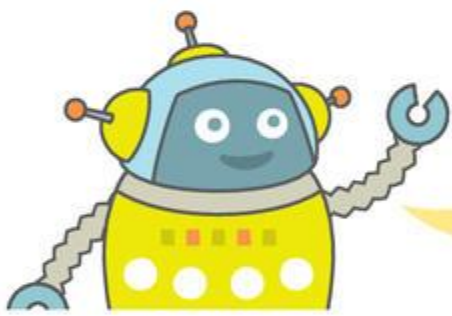
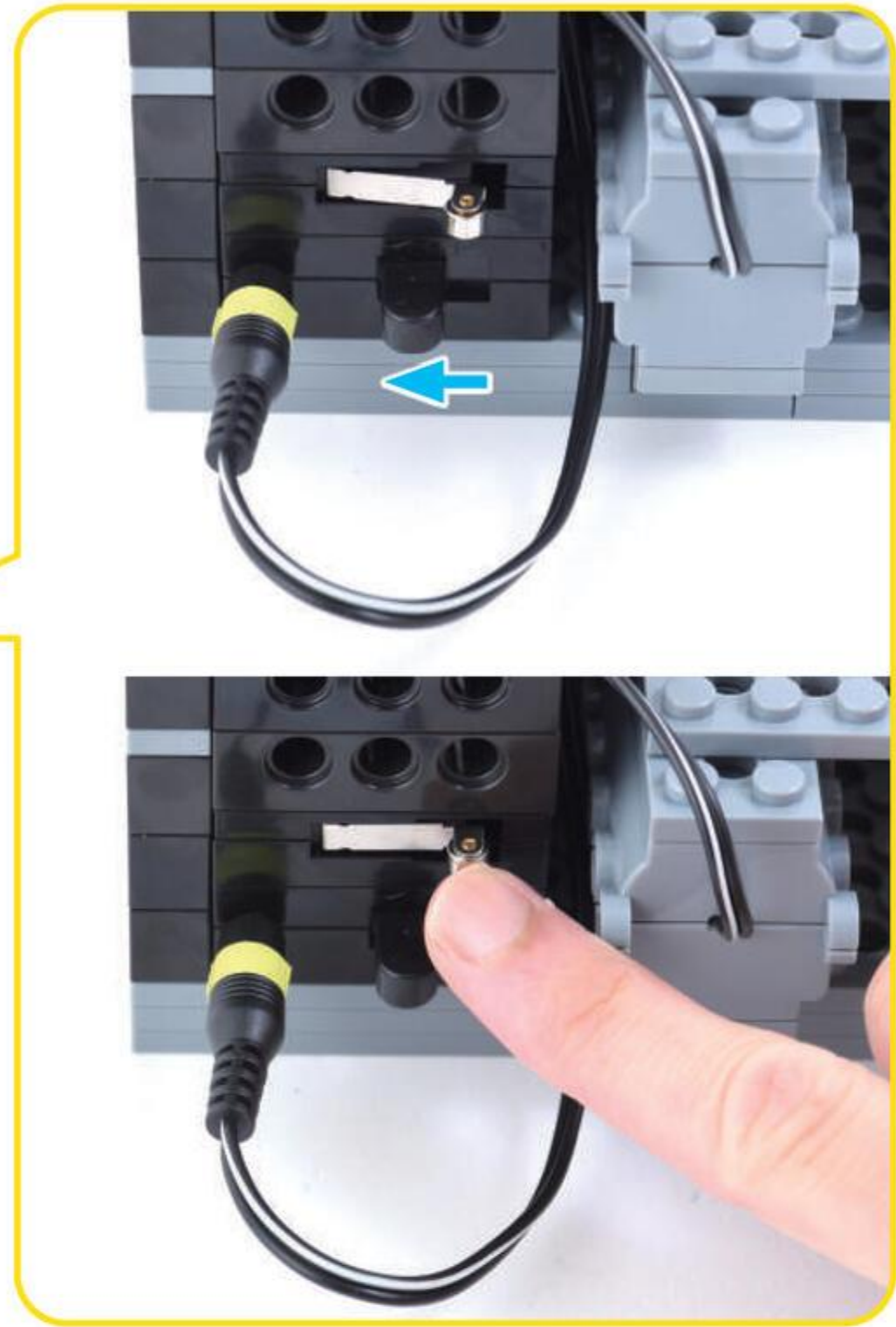
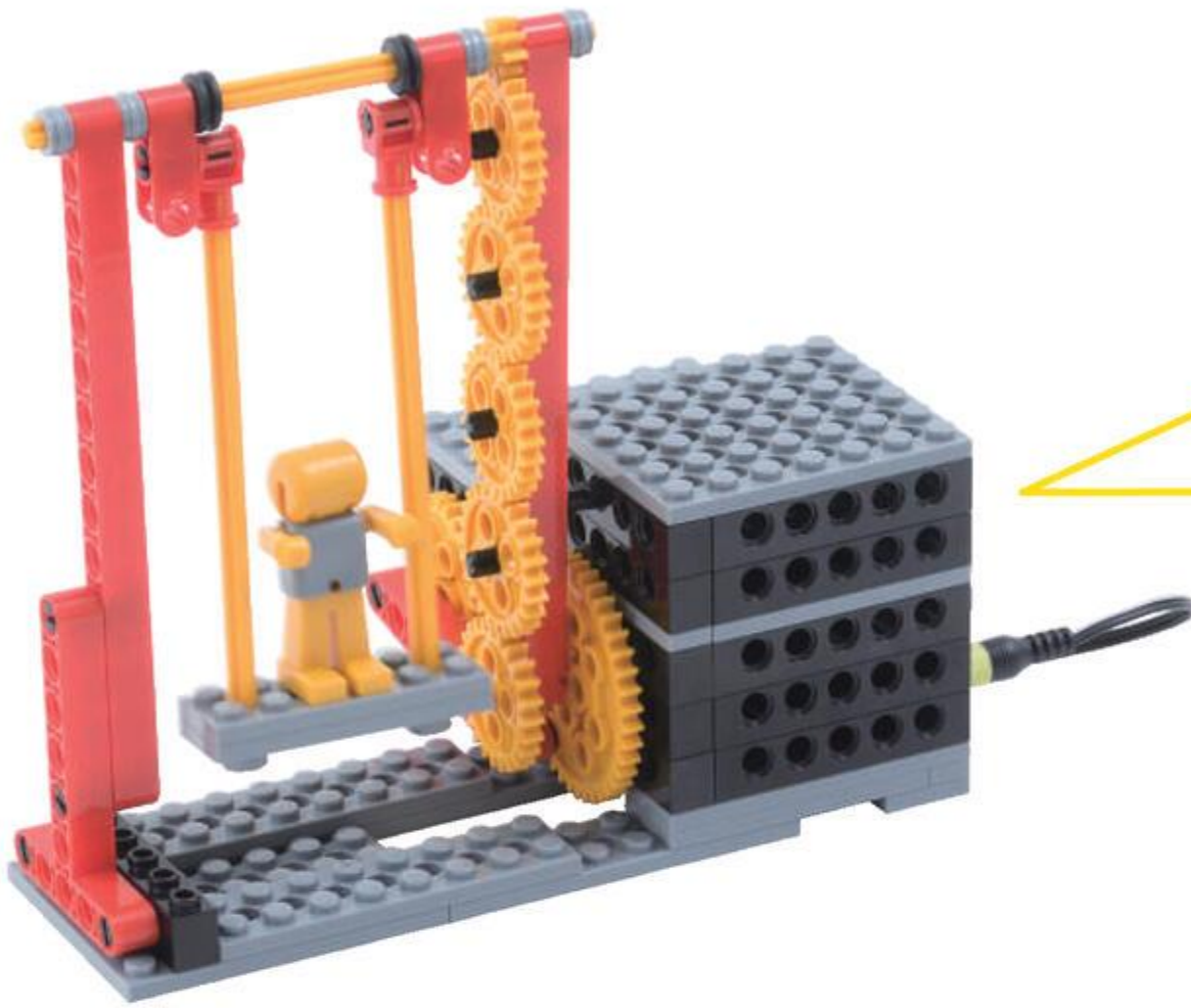

やじるしのむきに <sup>すいっち</sup> スイッチをいれて  
<sup>たっちせんさあ</sup> タッチセンサーをおしてみよう!



うごかし おわったら <sup>すらいどすいっち</sup> スライドスイッチを まんなかにもどそう



# 2 あたらしいじめん

めやす 5 ぶん

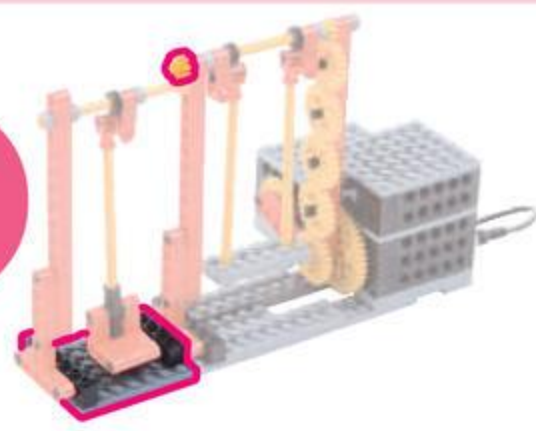

1

はずす

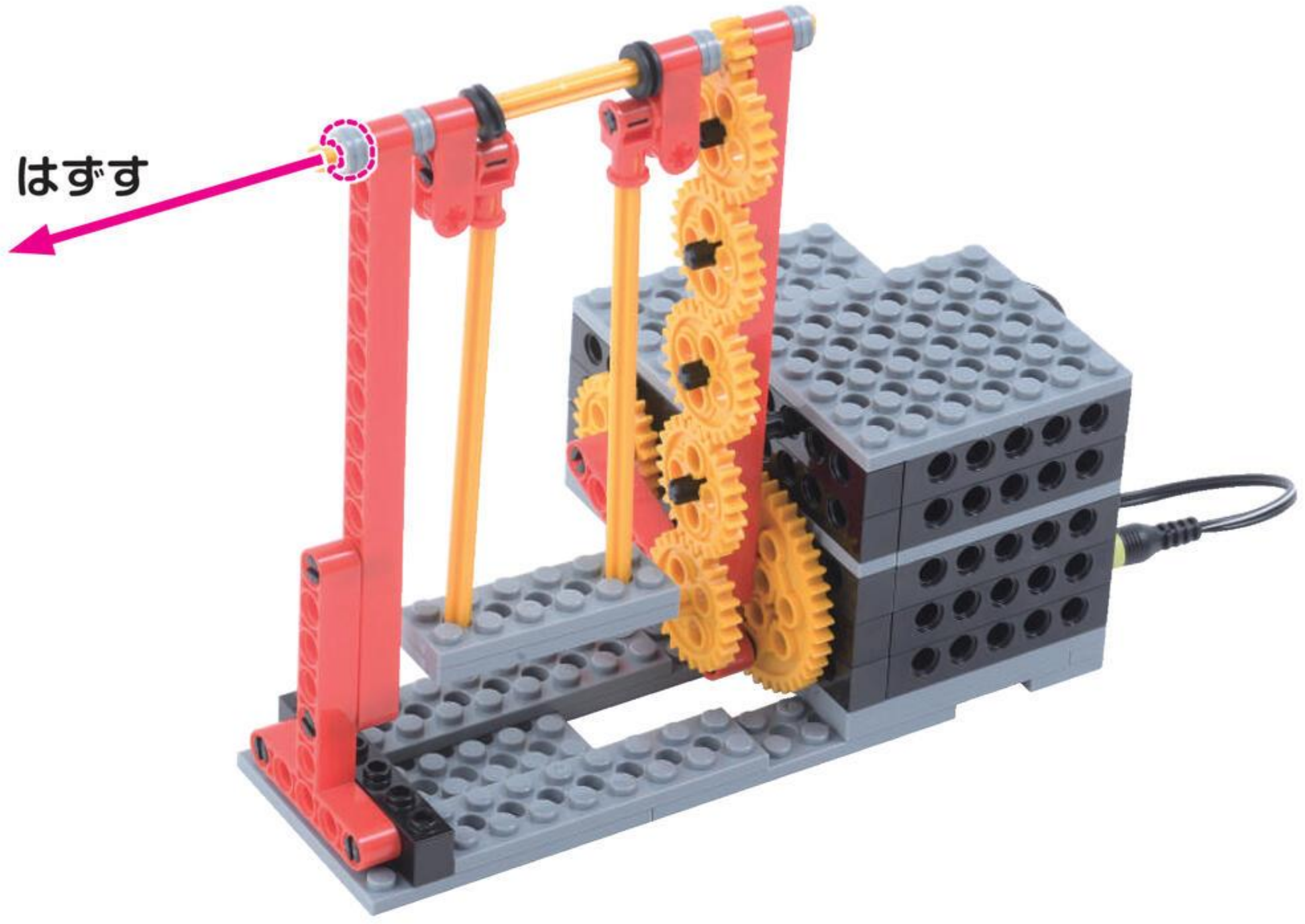

はずした <sup>ばあつ</sup> パーツは  
しまおう

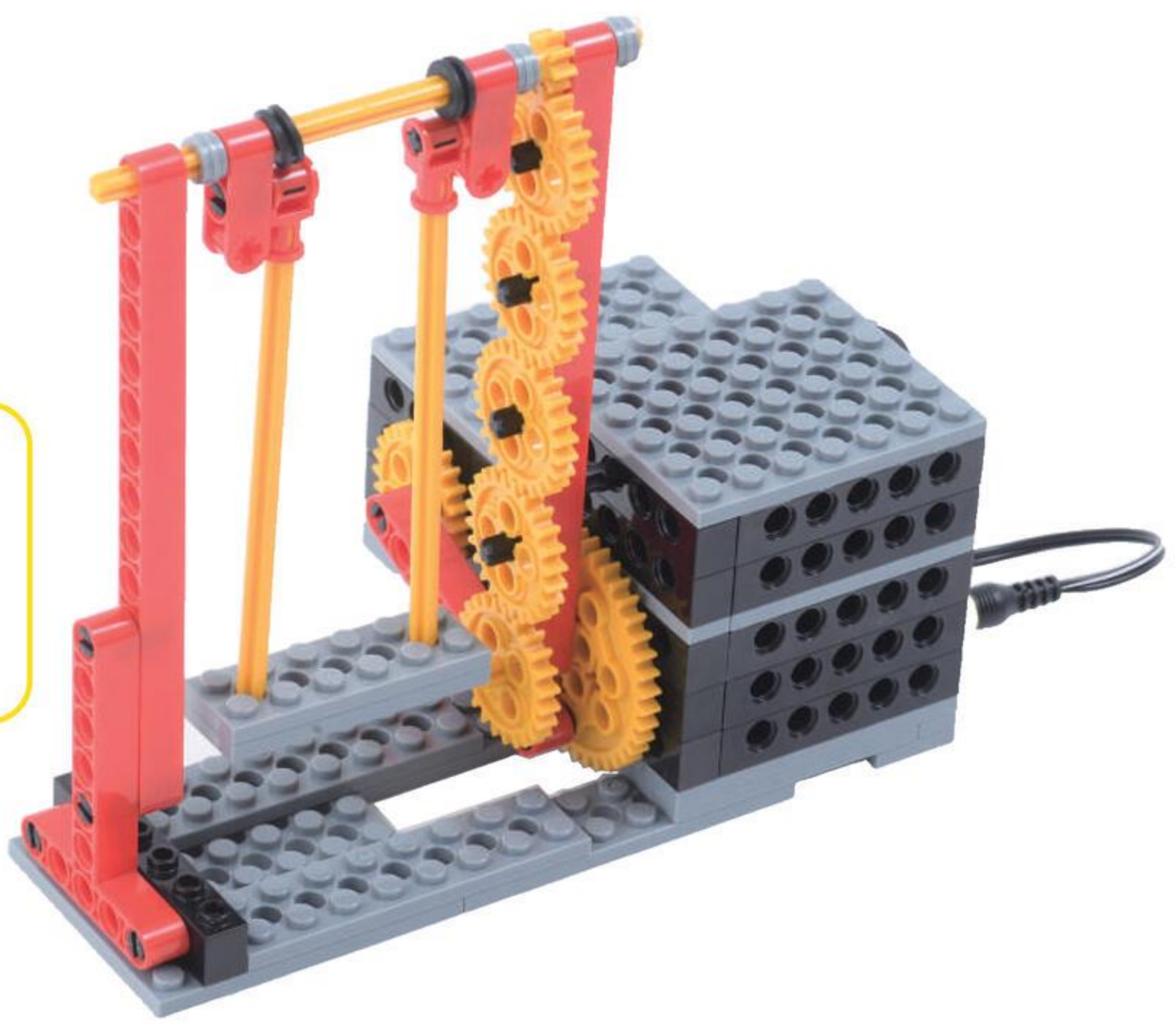



びにおんぎあ  
ピニオンギアうす 1こ

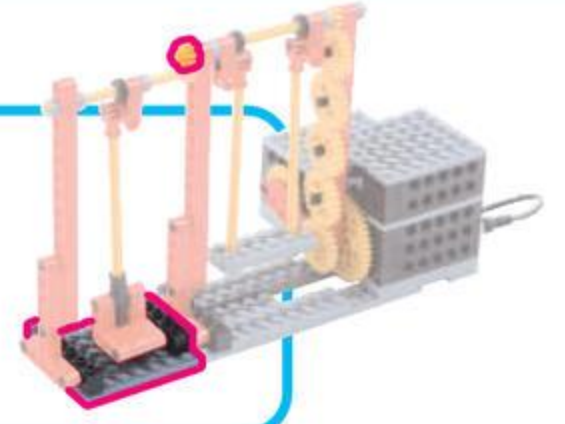

2

むきに ちゅうい



こちらを  
さしこむ

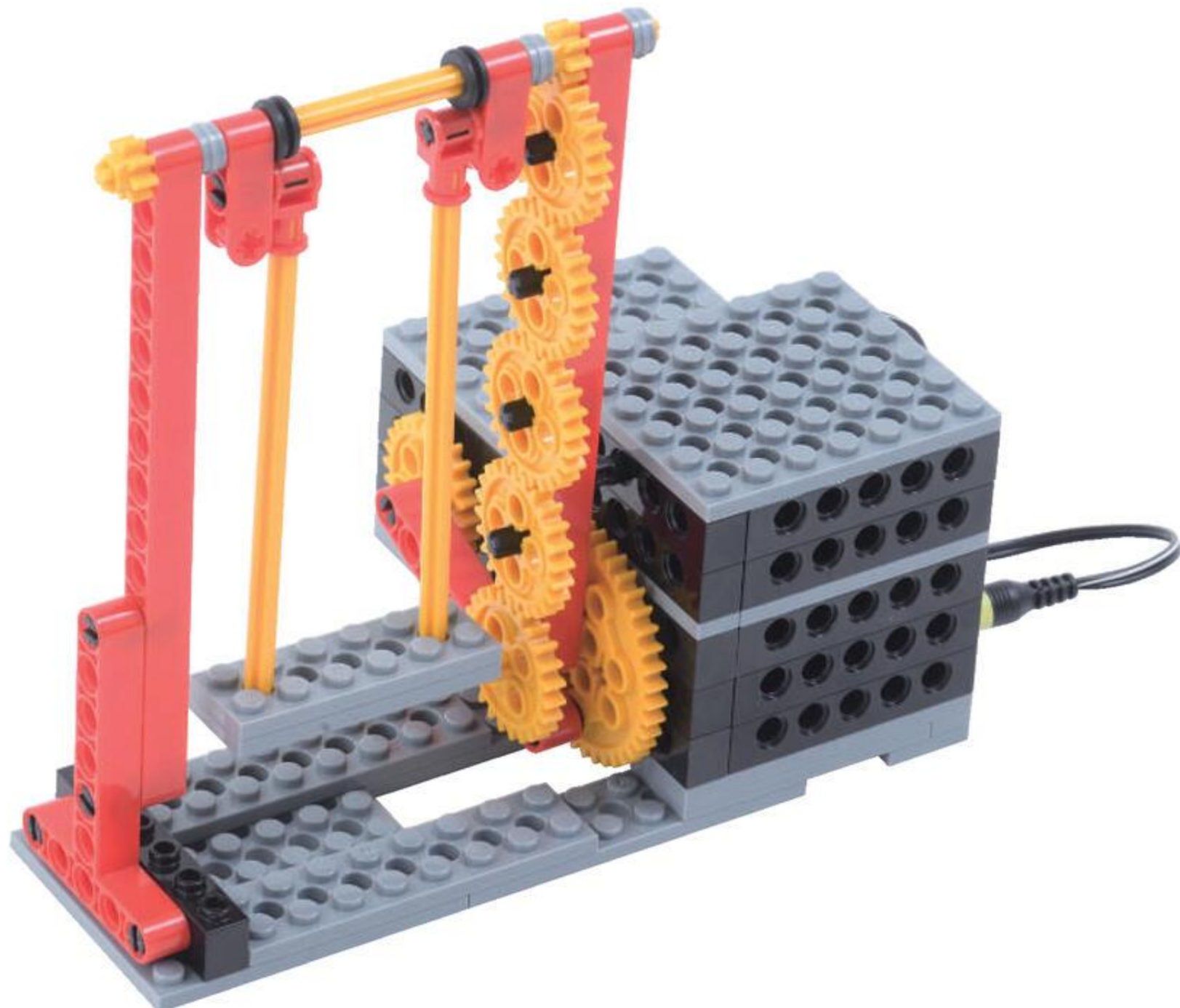
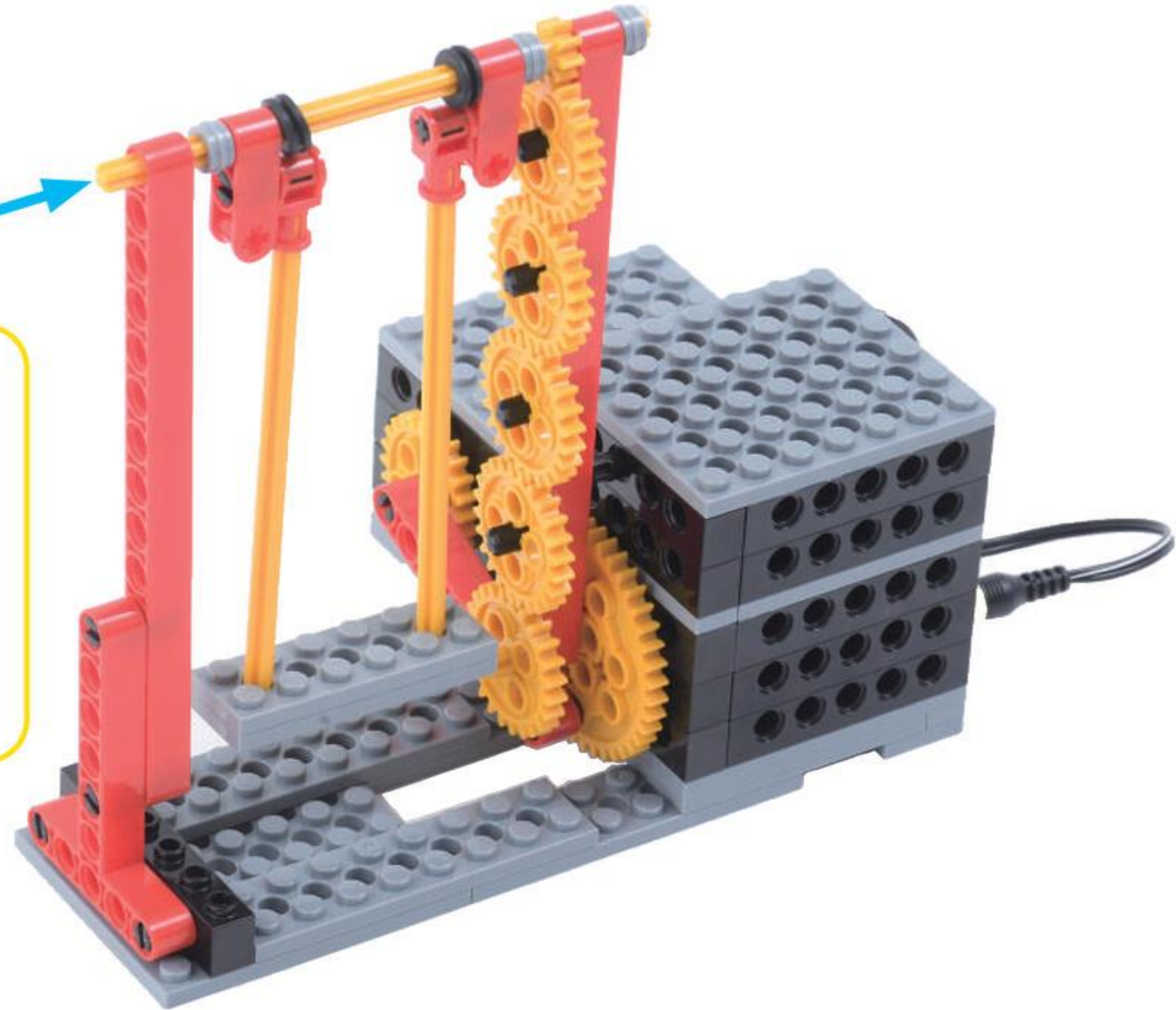



ぶれえとる プレート **1**こ

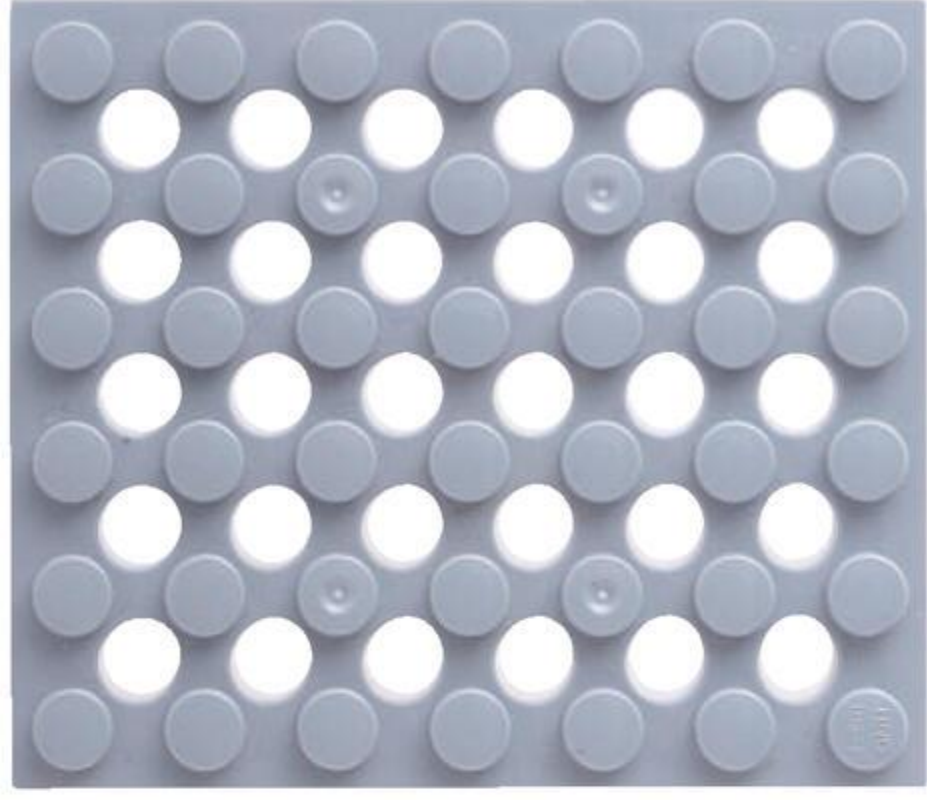

びいむろくほち ビーム 6ポチ **1**こ



びいむよんほち ビーム 4ポチ **1**こ

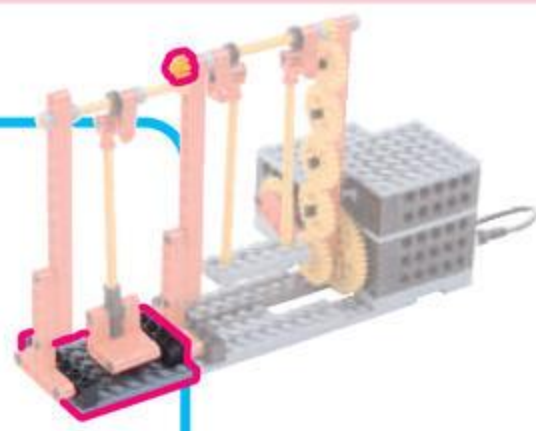

**3**

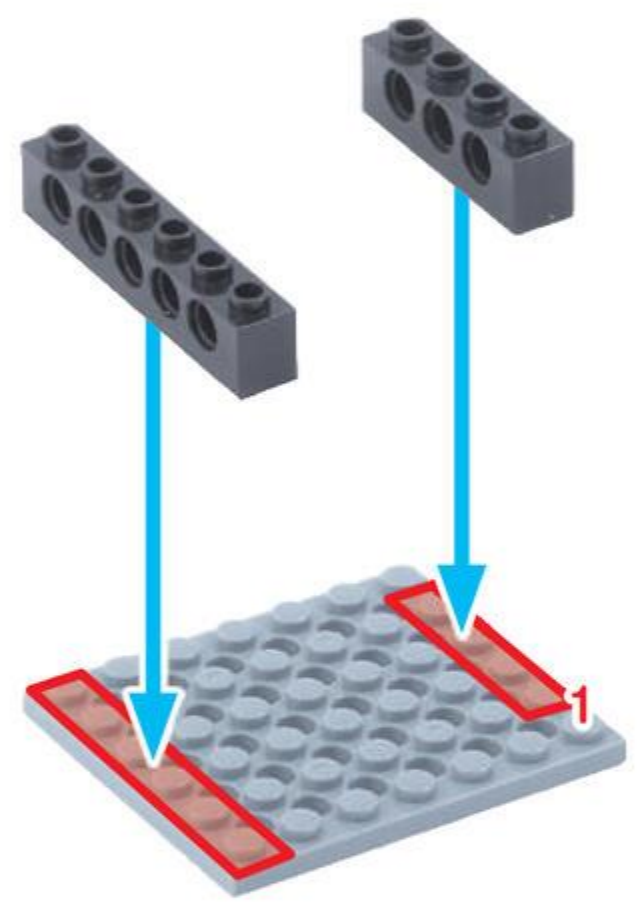



peg 2  
peg S 2

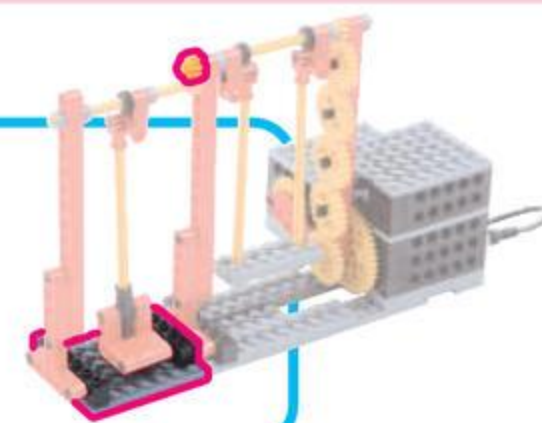

4

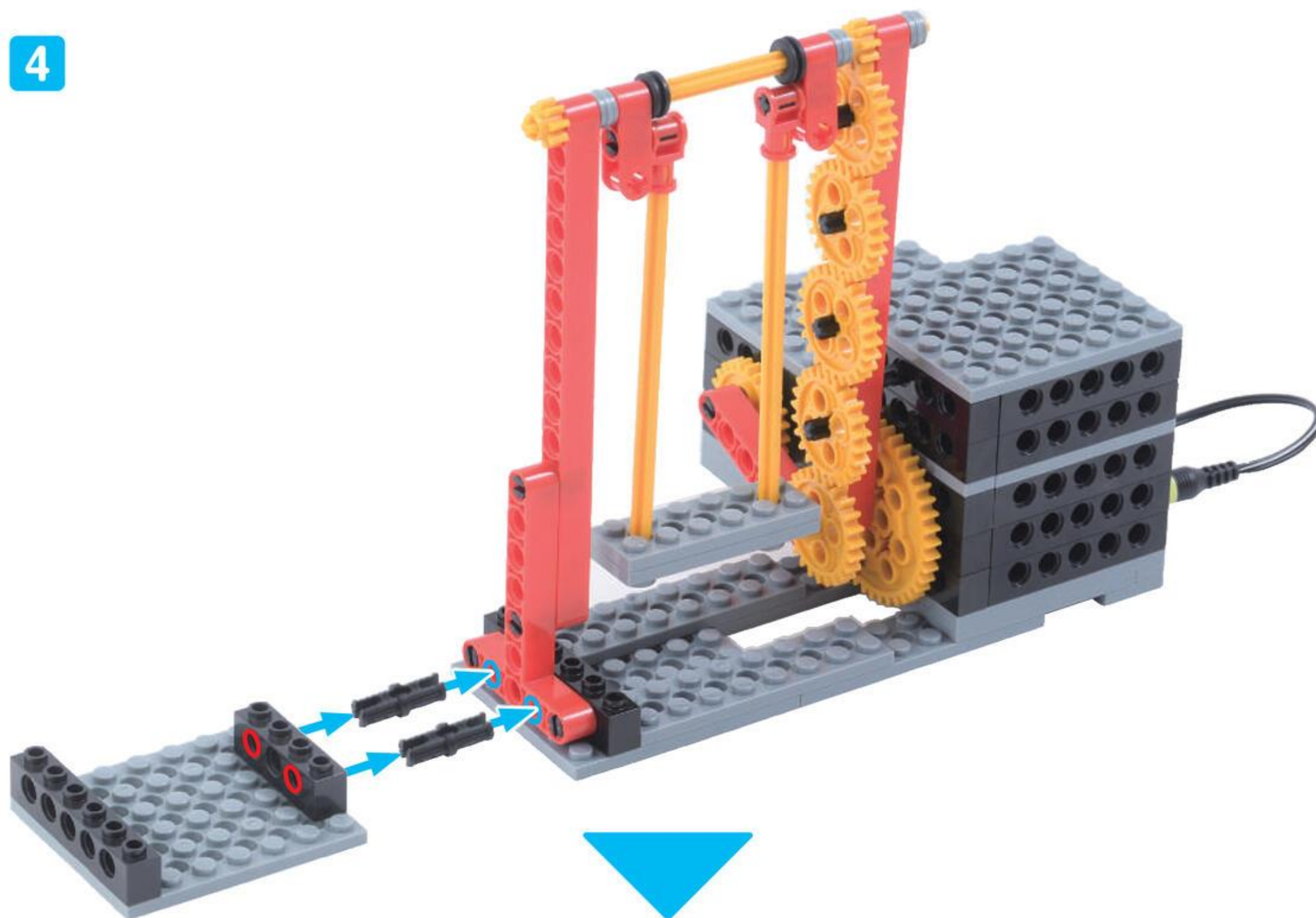

あたらしいじめんが  
かんせい!





**3** あたらしい <sup>ぶらんこ</sup> ブランコ めやす 15 ぶん

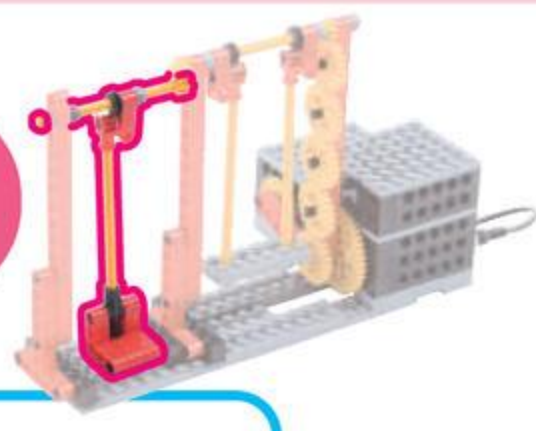

しやふと <sup>じゅう</sup> ぽち **1** こ  
**シャフト 10**

くろしやふと <sup>いってん</sup> ぽち **1** こ  
**黒シャフト 1.5**

くろすじょいんと **1** こ  
**クロスジョイント**

あなしやふと <sup>じょいんと</sup> **1** こ  
**アナシャフトジョイント**

てい <sup>じょいんと</sup> **1** こ  
**T ジョイント**

ながさに  
ちゅうい

○ みじかい  
 × ながい





peg 2  
peg 2



rod 2  
rod 2

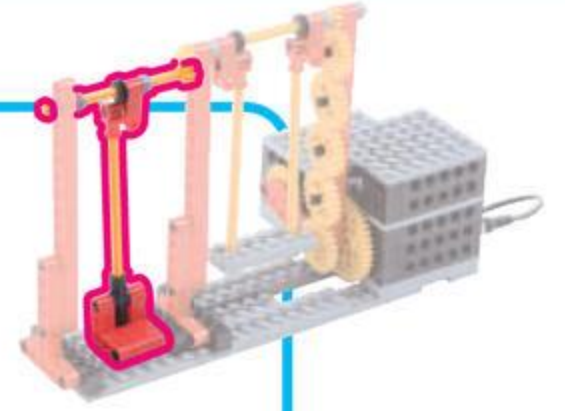

2

short side  
short side



short side long side

insert into this short side

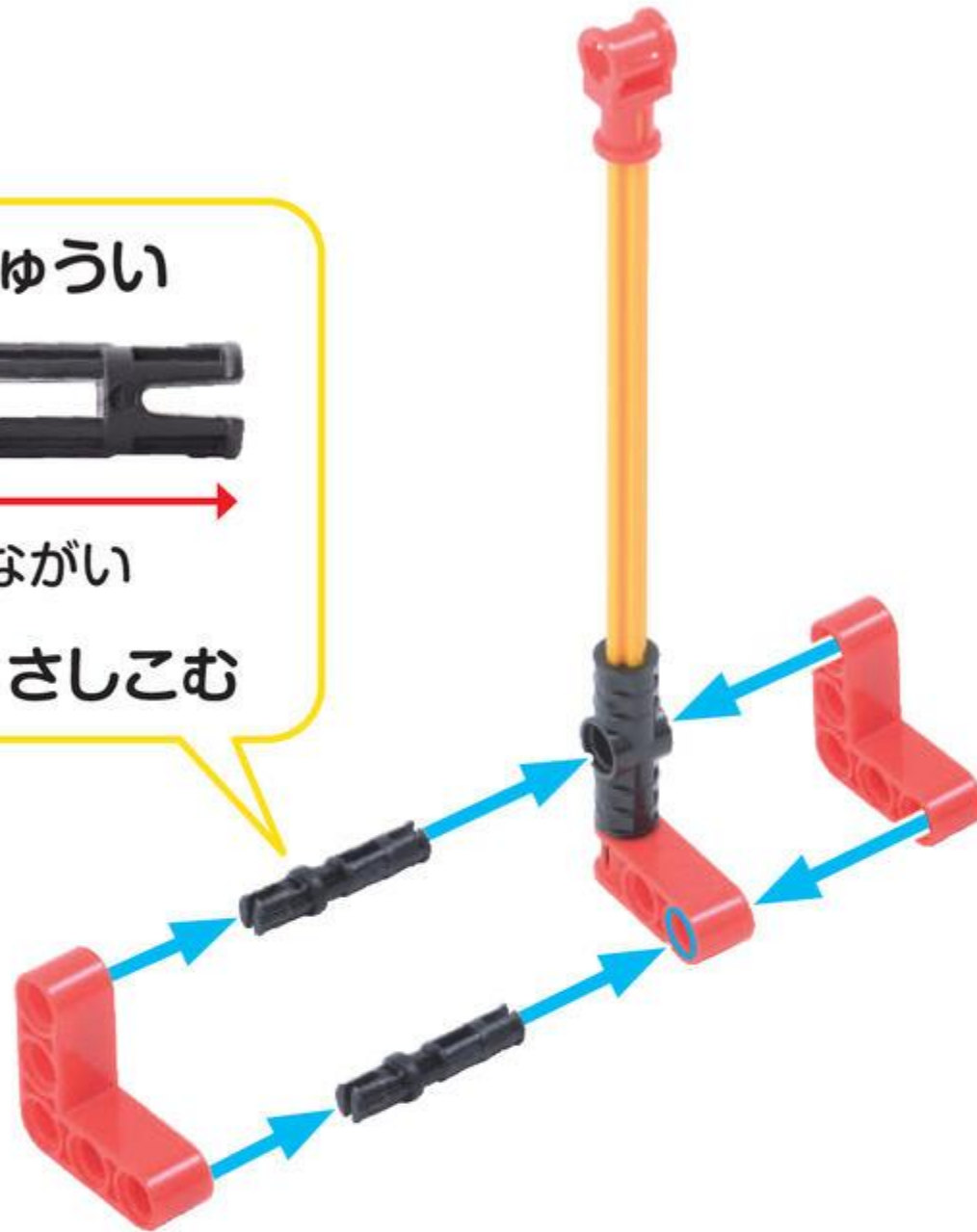



くるすじょいんと  
クロスジョイント 1こ



しゃふとペグ  
シャフトペグ 1こ

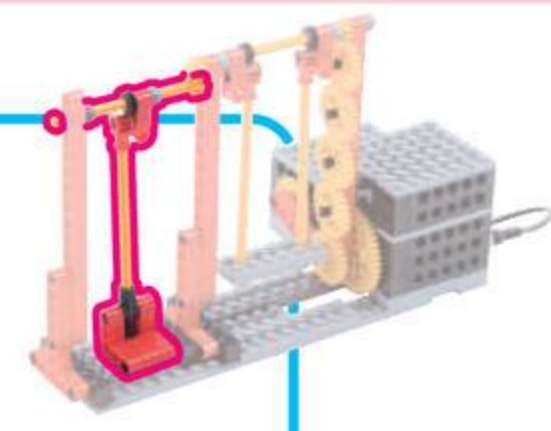
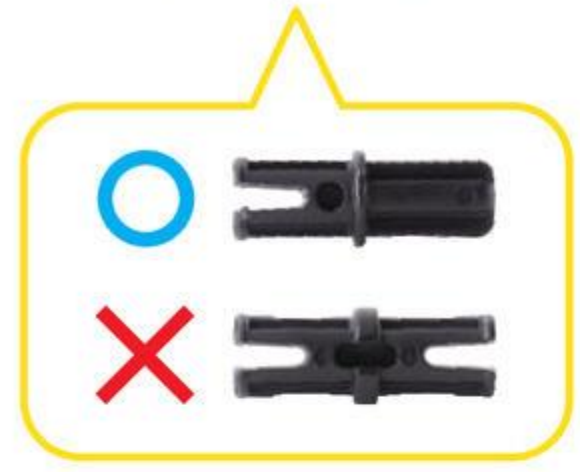

3





しゃふとじゅうぼち  
シャフト 10 ポチ 1こ



ぴにおんぎあ  
ピニオンギアうす 1こ



くろめつと  
グロメット 1こ



ぶっしゅ  
ブッシュ 2こ

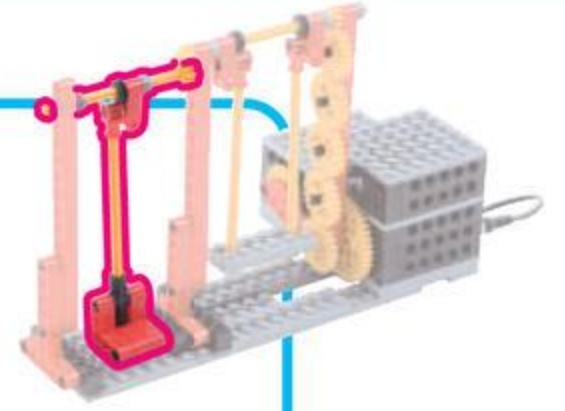

4



むきに ちゅうい



こちらを  
さしこむ





5

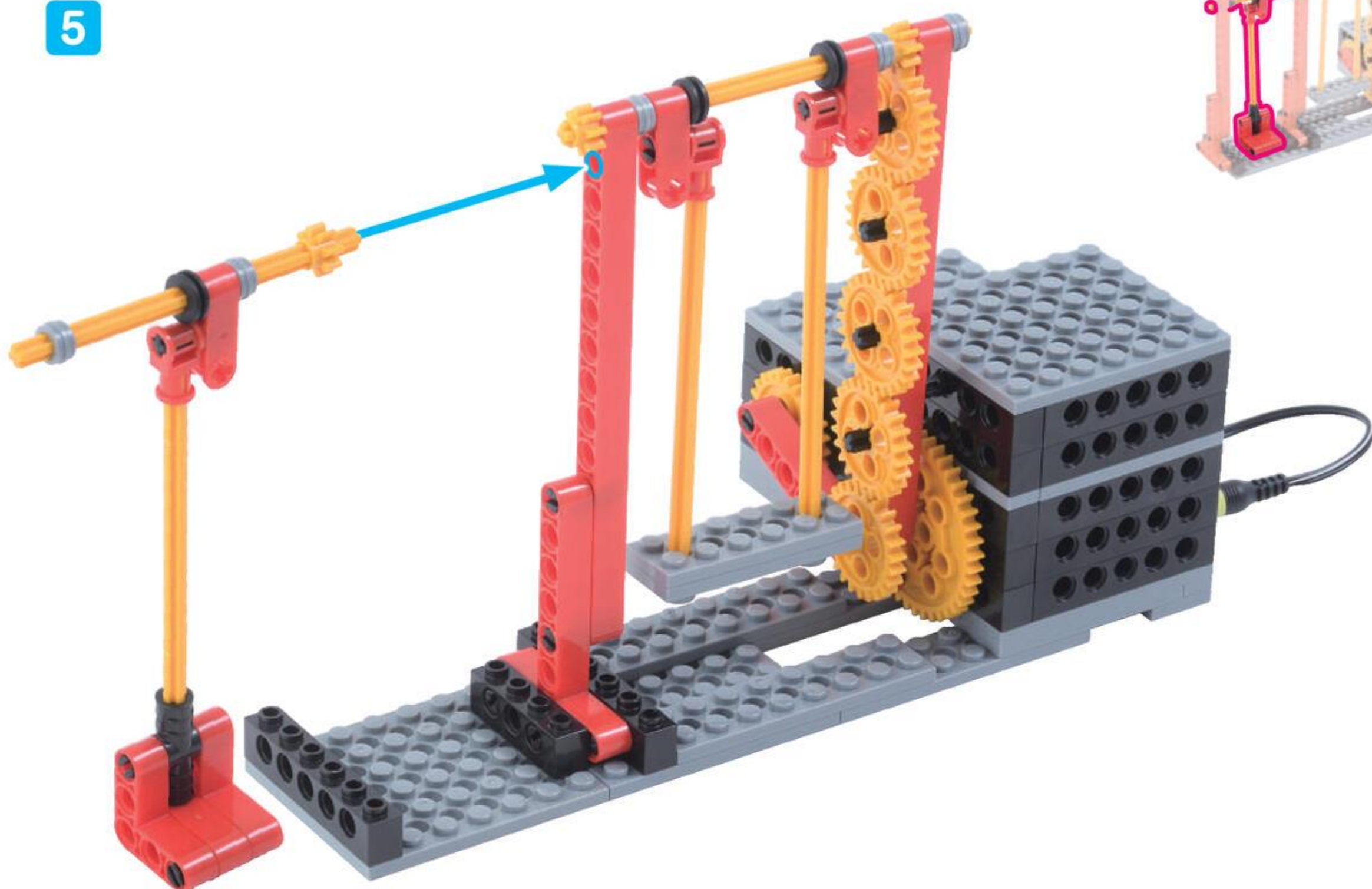

しっかり かみあわせよう

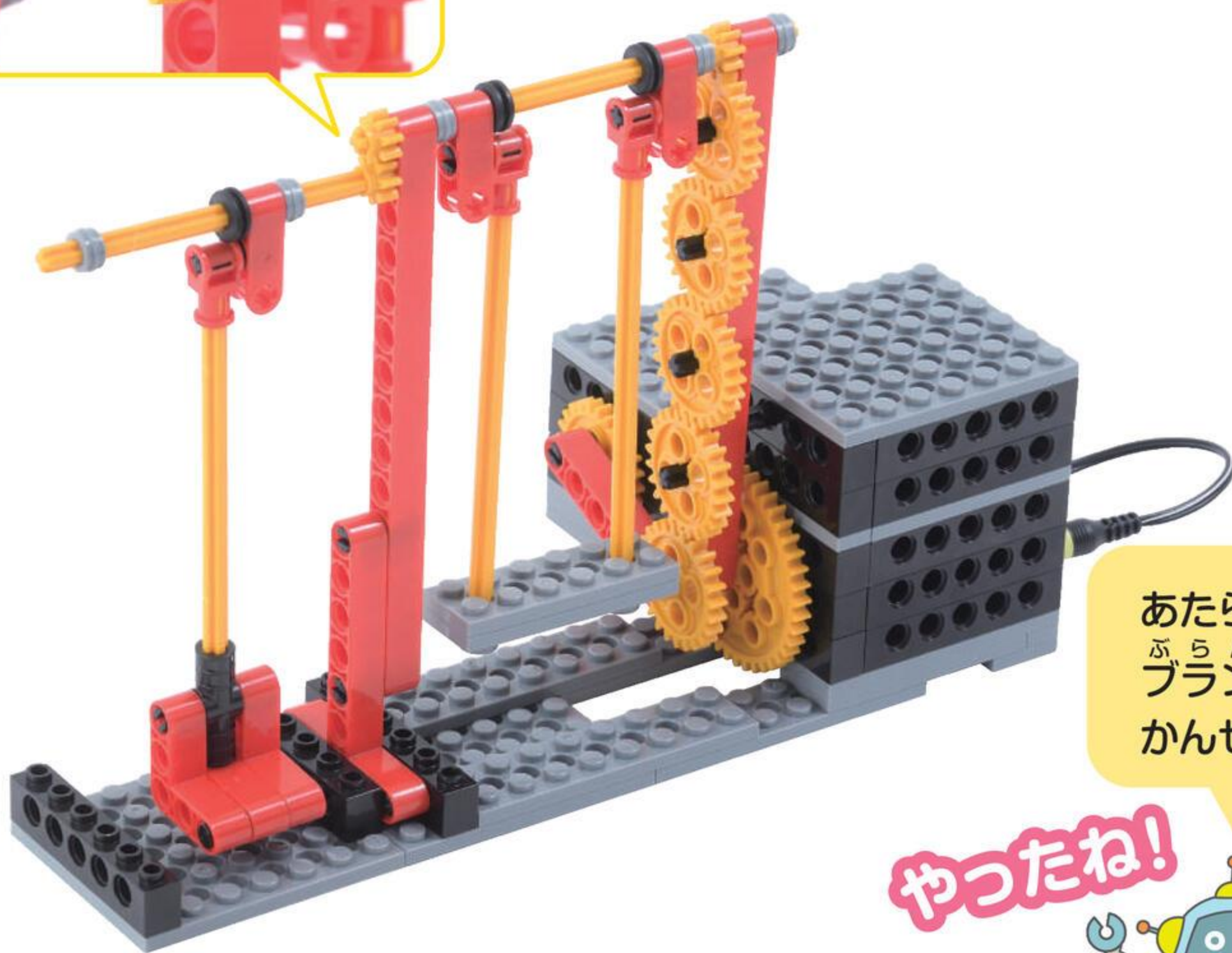

あたらしい  
ぶらんこが  
かんせい!

やったね!

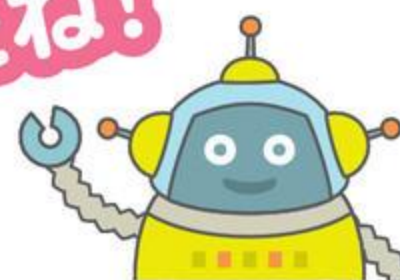



# 4 あたらしい はしら

めやす 5 ふん

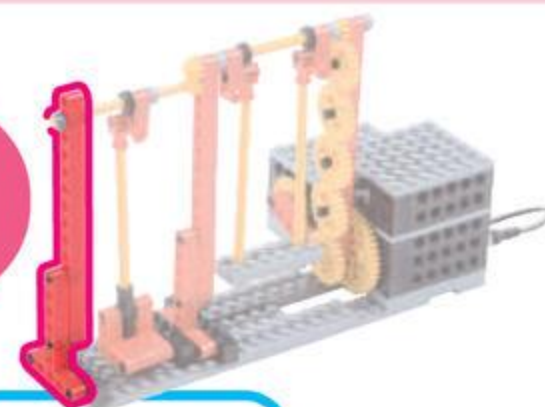

てい るっど  
T ロッド 1こ

ぺぐ えす  
ペグ S 4こ

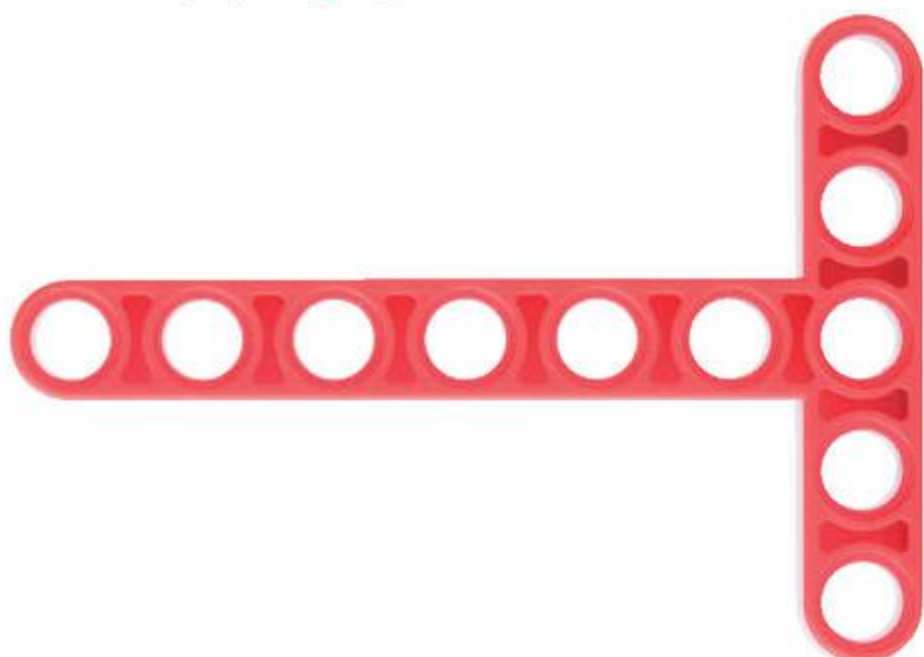

1

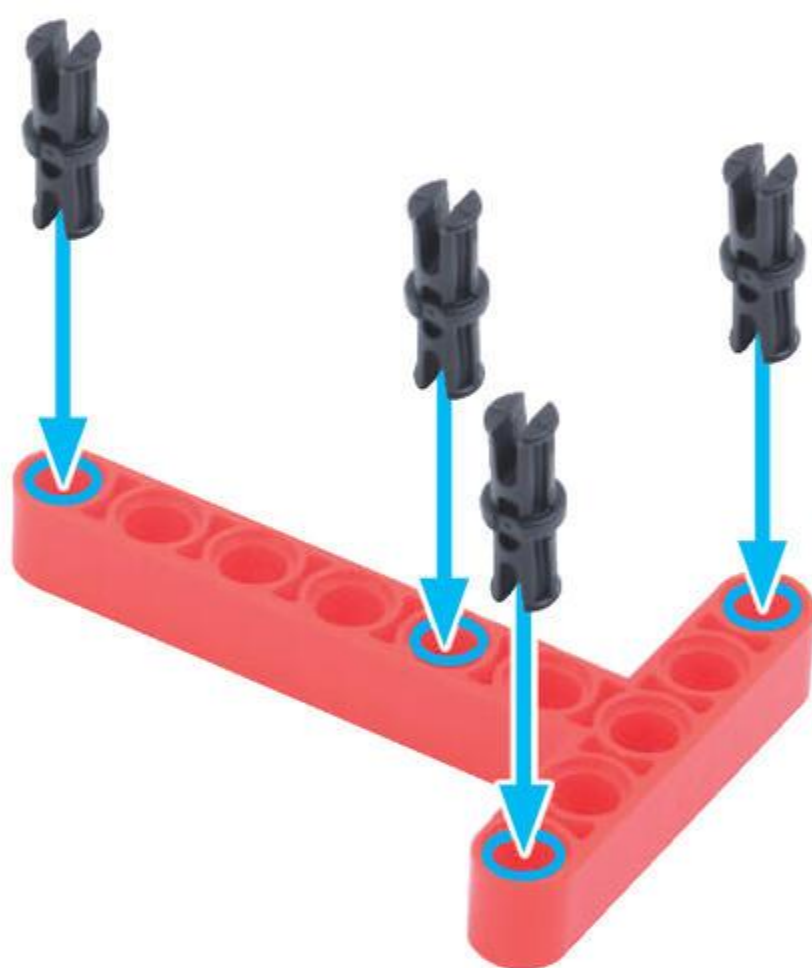



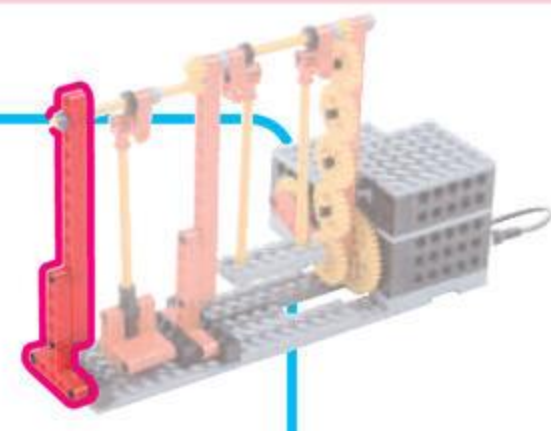

ろっど しゅうご あな **1**こ  
ロッド 15 アナ



**2**

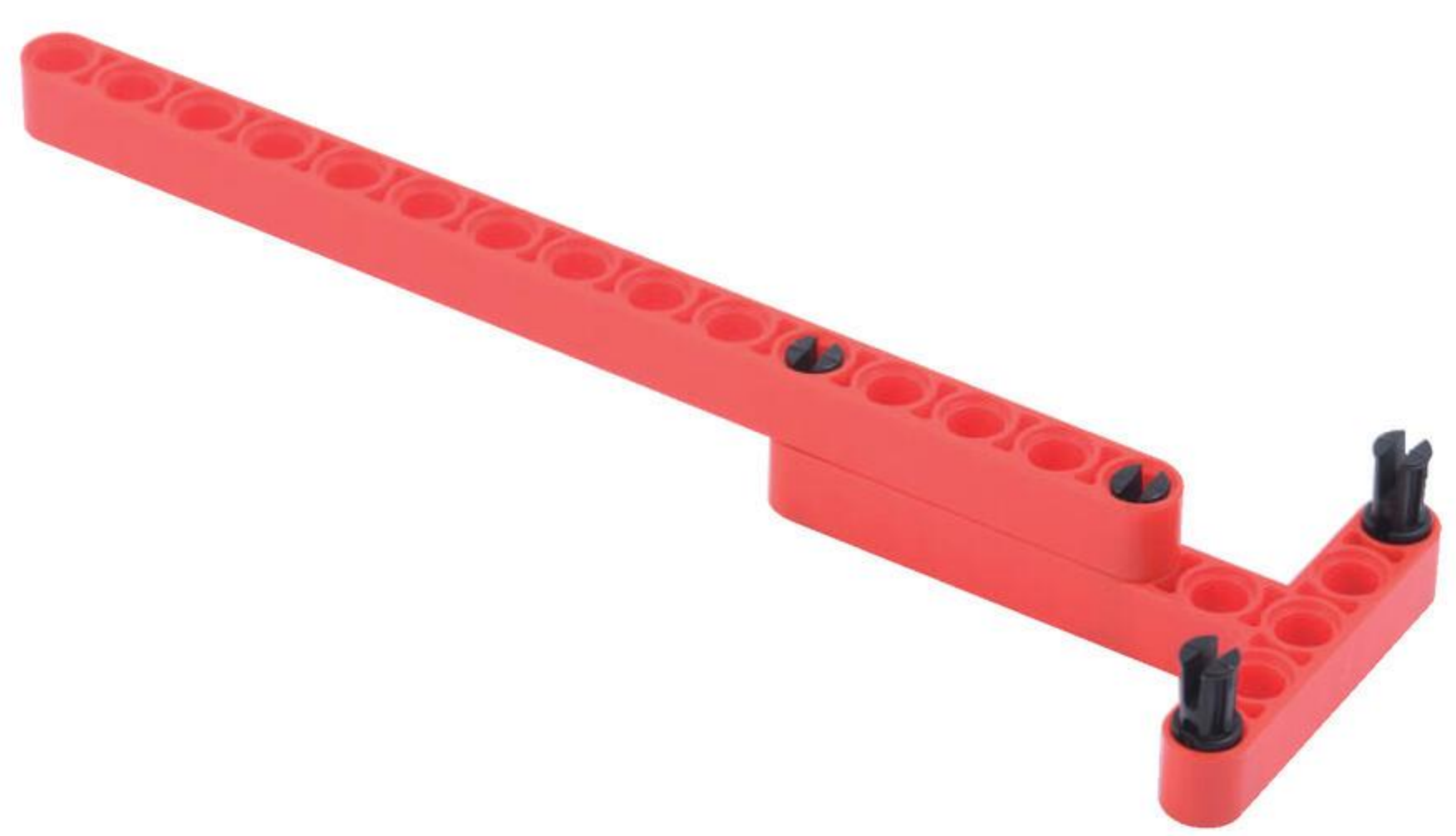
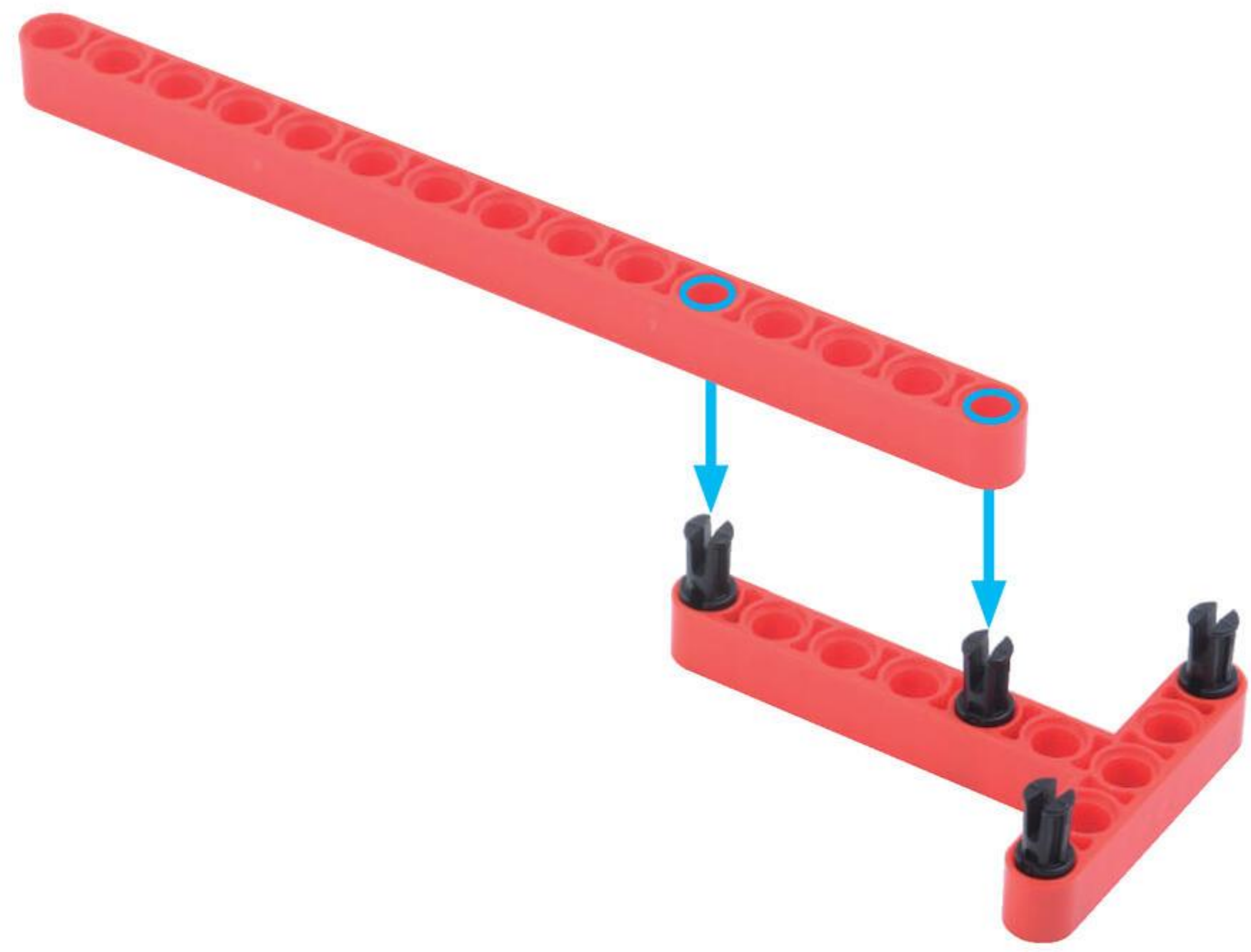



ぶっしゅ 1こ

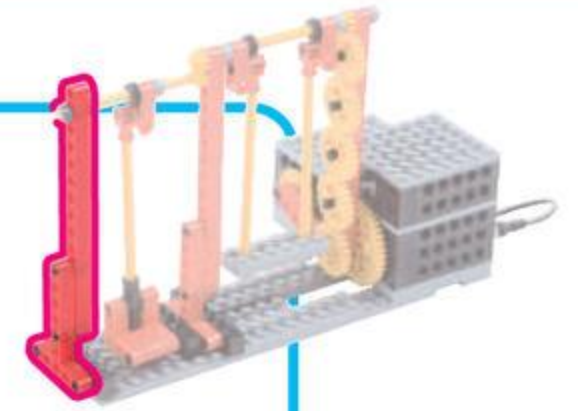

3

あな  
アナのいちに  
ちゅうい

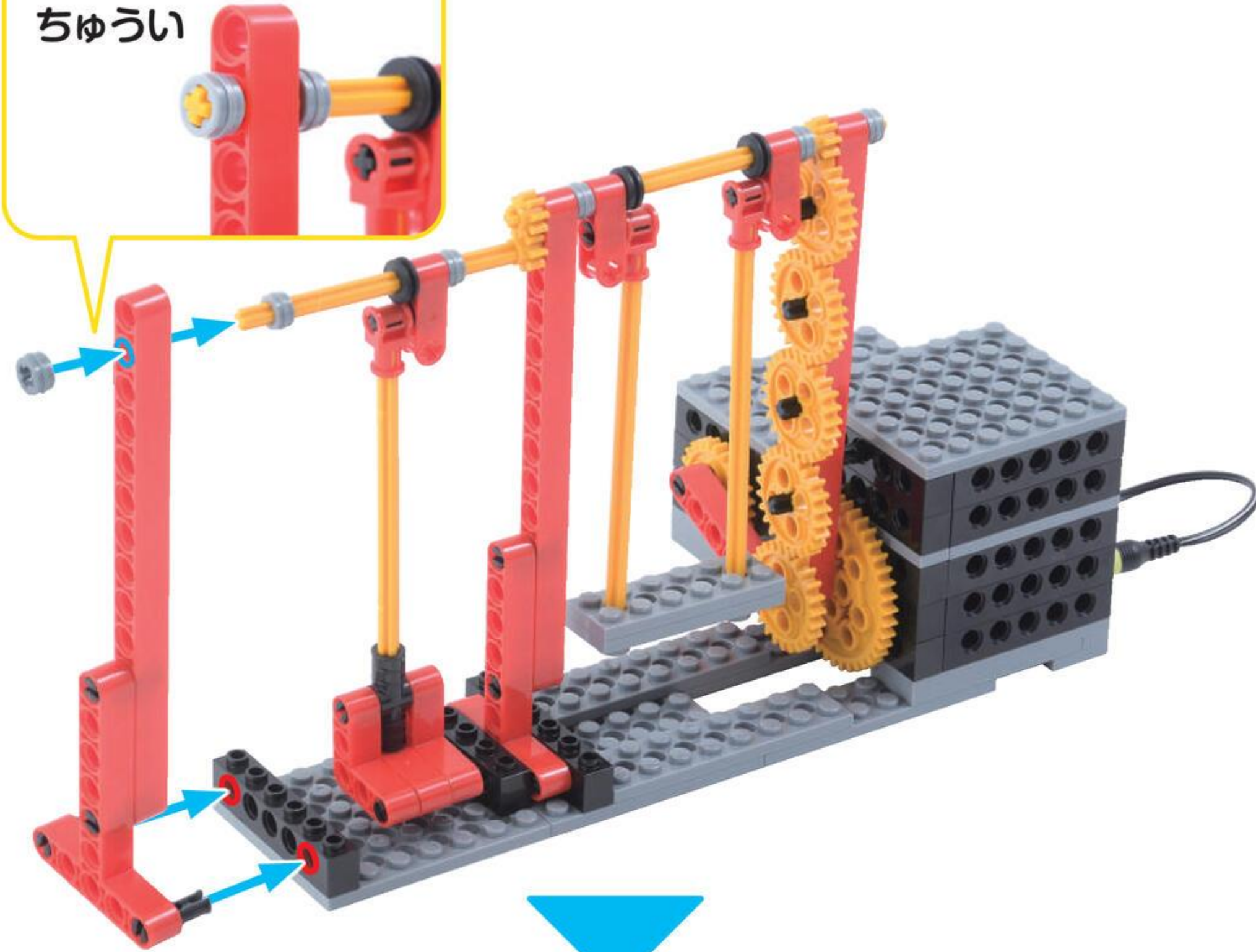

これで  
かんせい!

よくできました!

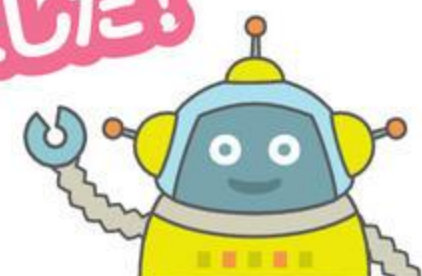



# ロボットをうごかそう

めやす 15 ぶん

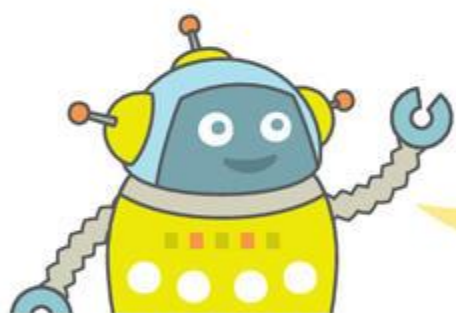
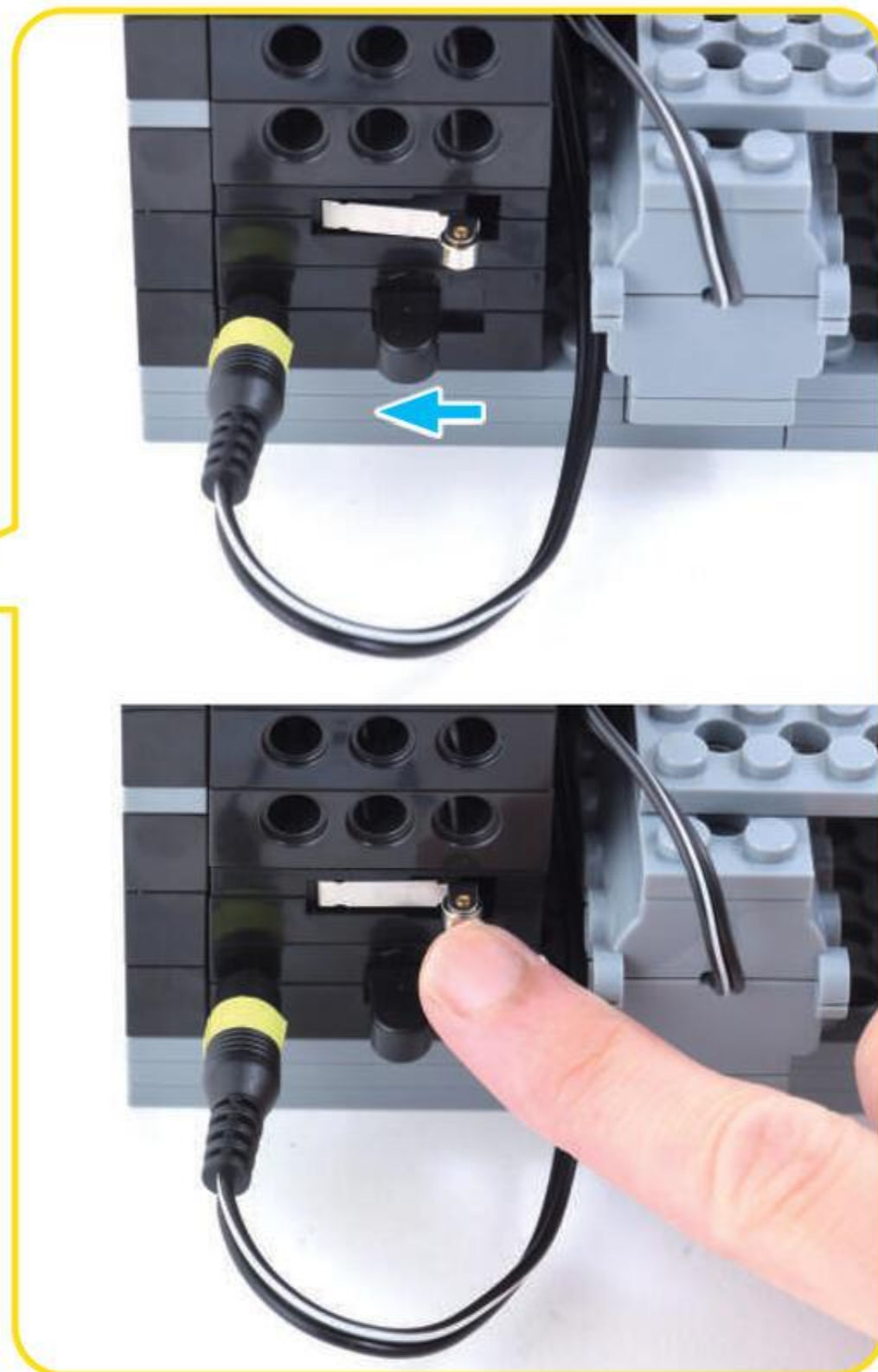
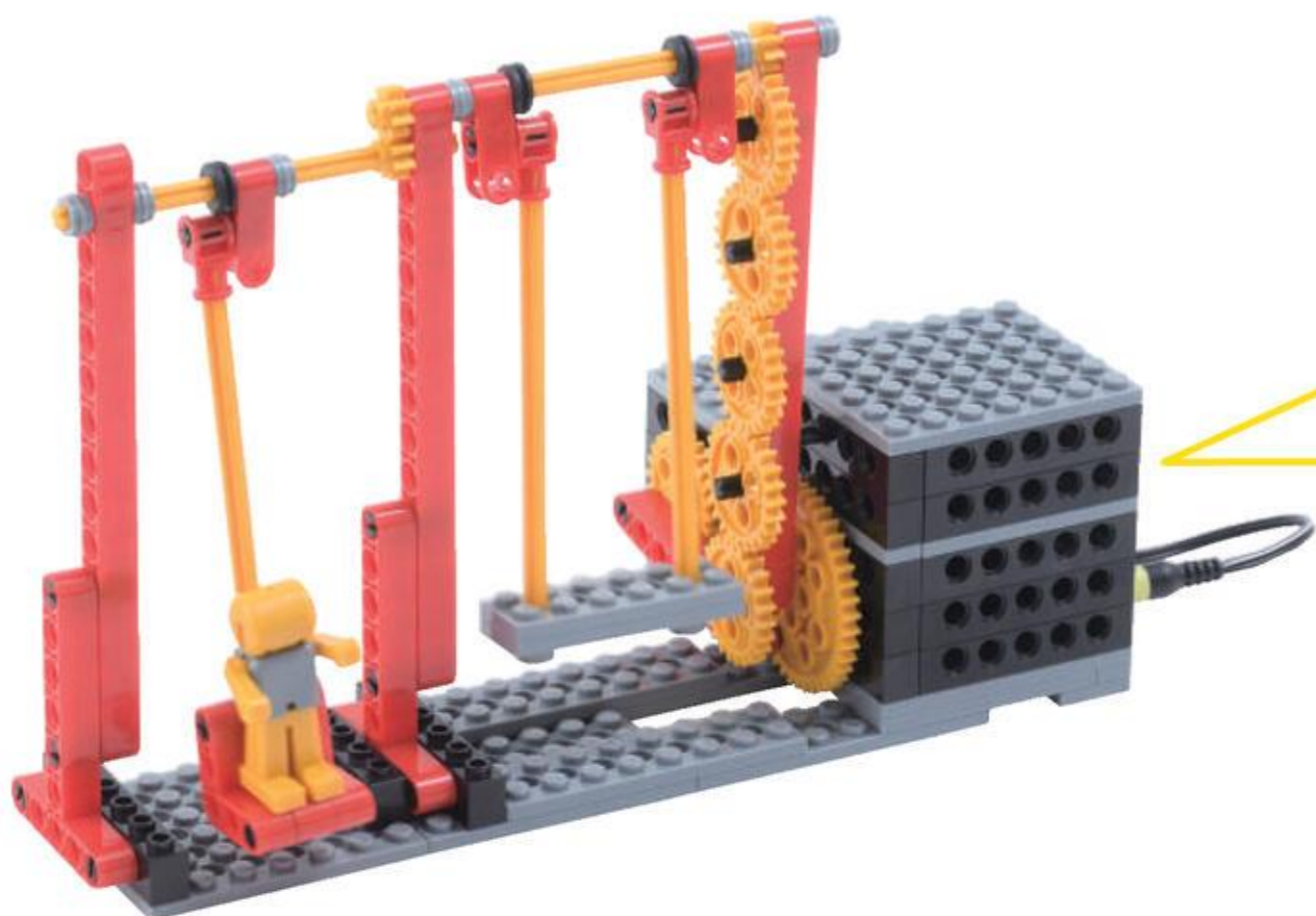

やじるしのむきに <sup>すい</sup> <sup>ち</sup> スイッチをいれて  
 <sup>た</sup> <sup>っ</sup> <sup>ち</sup> <sup>せ</sup> <sup>ん</sup> <sup>さ</sup> <sup>あ</sup> タッチセンサーをおしてみよう!





# じゆうにかいぞうしてみよう

めやす 10 ぶん

ばあつ  
パーツをつかって、じゆうにかいぞうしてみよう！

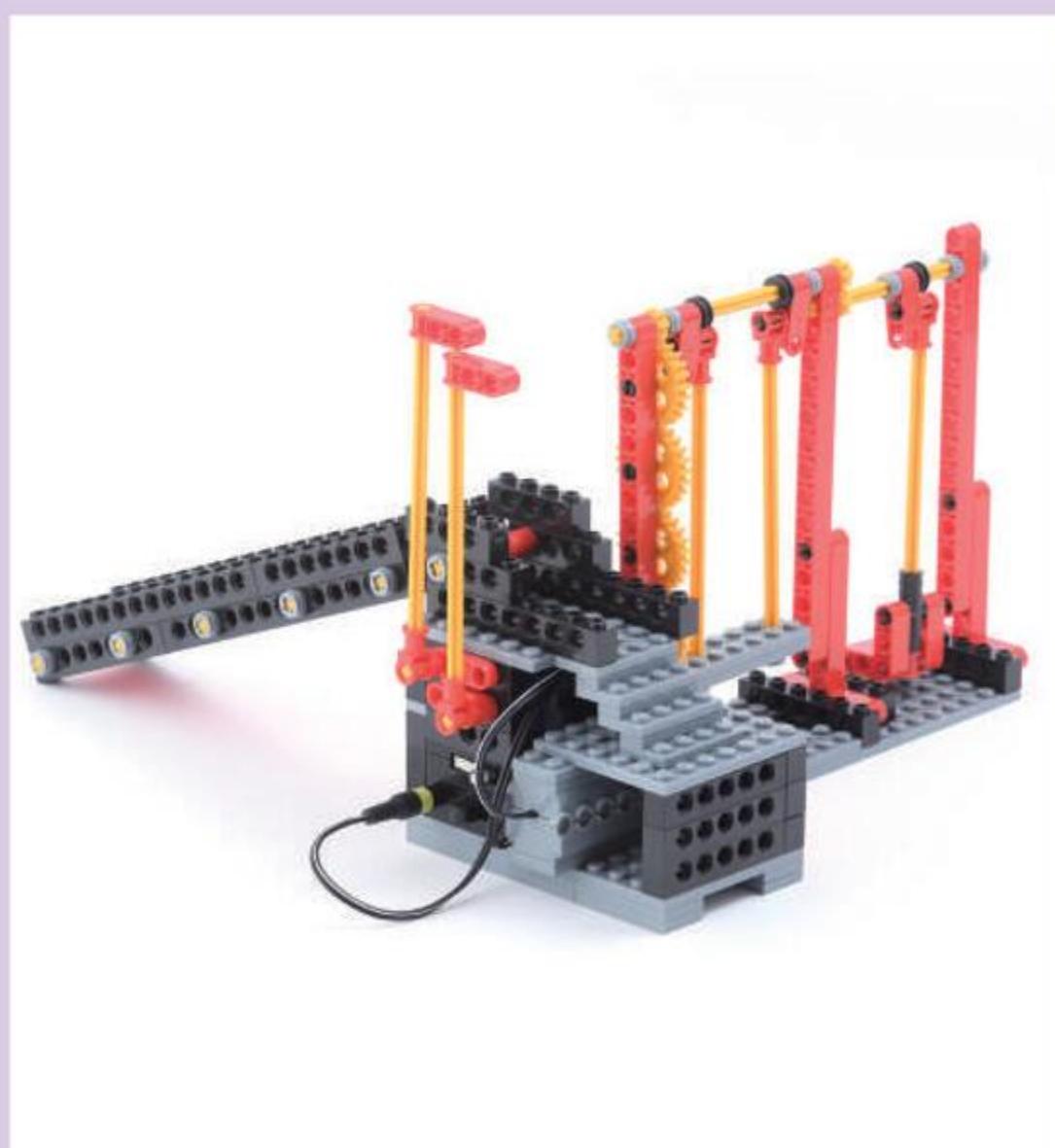

たのしく あそべるように しよう！

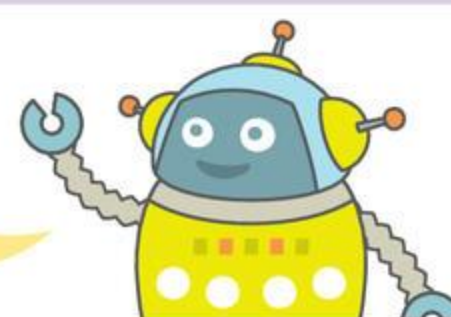



# まちがいさがし

めやす 3 ぶん



ちがうところを みつけよう  
2つあるよ!

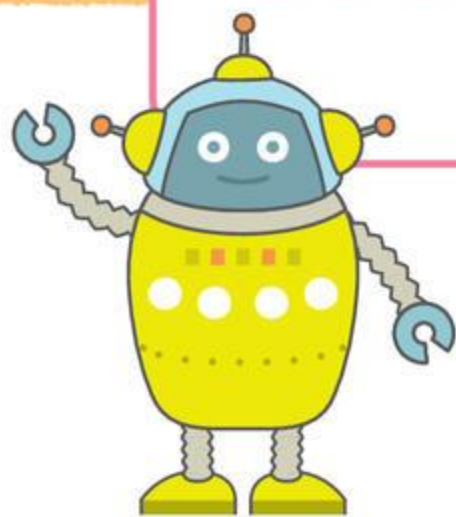



# じかいの ろぼっと

じかいつくる<sup>ろぼっと</sup>ロボットは  
はいたつ<sup>ろぼっと</sup>ロボット  
「<sup>も</sup>つて<sup>く</sup>て<sup>く</sup>」

ものを はこびながら  
まえに すすむ<sup>ろぼっと</sup>ロボットだよ

