



Human

ヒューマンアカデミー ジュニア
STEAMスクール



ロボット教室

ロボットのきょうかしよ

プレプライマリーコース B

1

おやこで わんつう ワンツウ「かやっくん カヤックン」

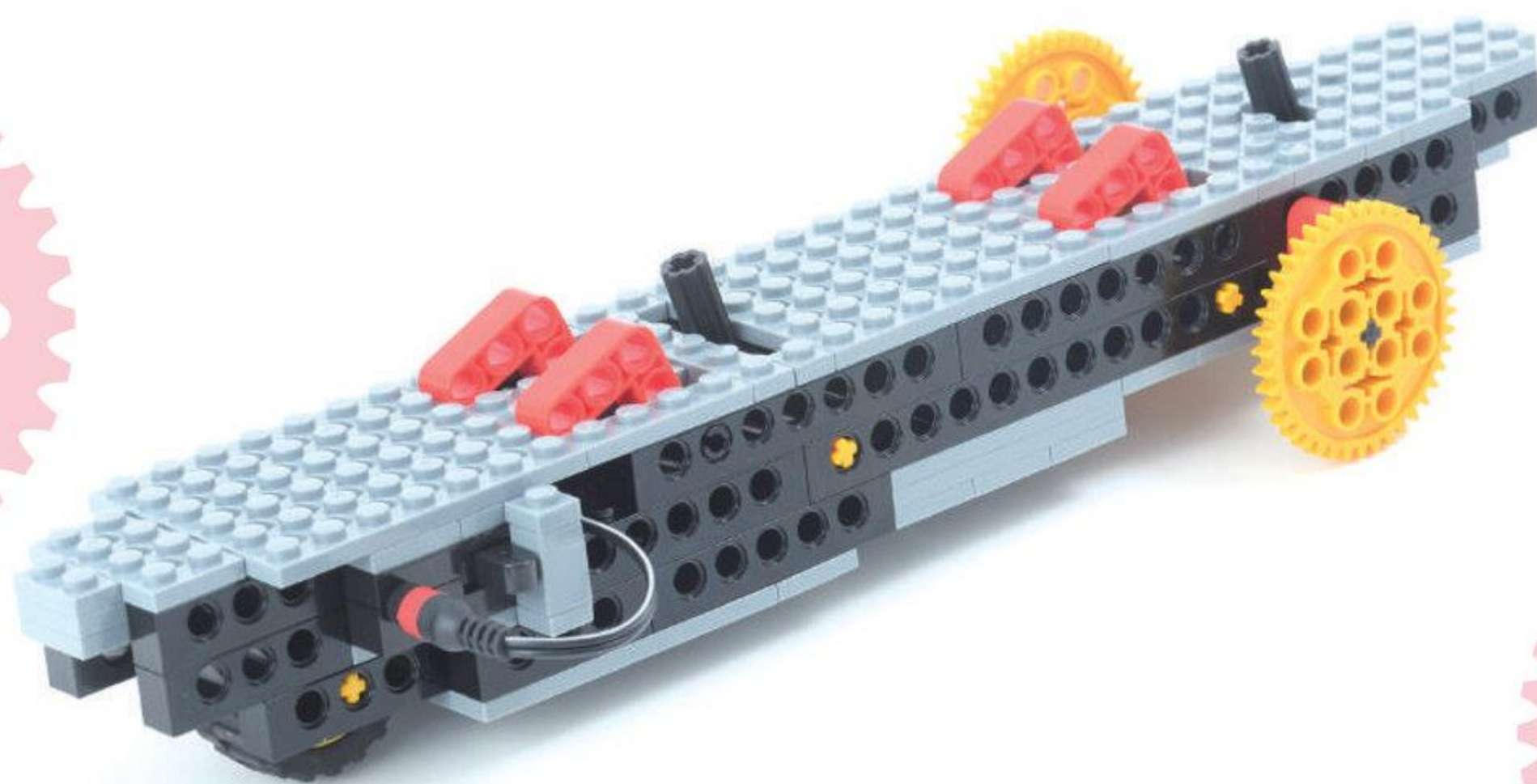

今回のロボットは、第12回ヒューマンアカデミーロボット教室全国大会
アイデアコンテストプライマリーコースの部で最優秀賞に選ばれた沼田樹さん
(宮城県 仙台上杉教室・当時年長)の作品「ロボカヤック」を元に、高橋智隆
先生が改ざうしたロボットです。

★だい1かい

2024ねん

9がつ

にち

なまえ

ちゅうい しょう

ばあっ パーツや でんきぶひんを あんぜんにつかうために

! ばあっ パーツを くちに いれない

くみたてた ばあっ パーツを とりはずすときは、
ぜったいにはをつかてはいけません。
ばあっ パーツを のみこんでは いけません。

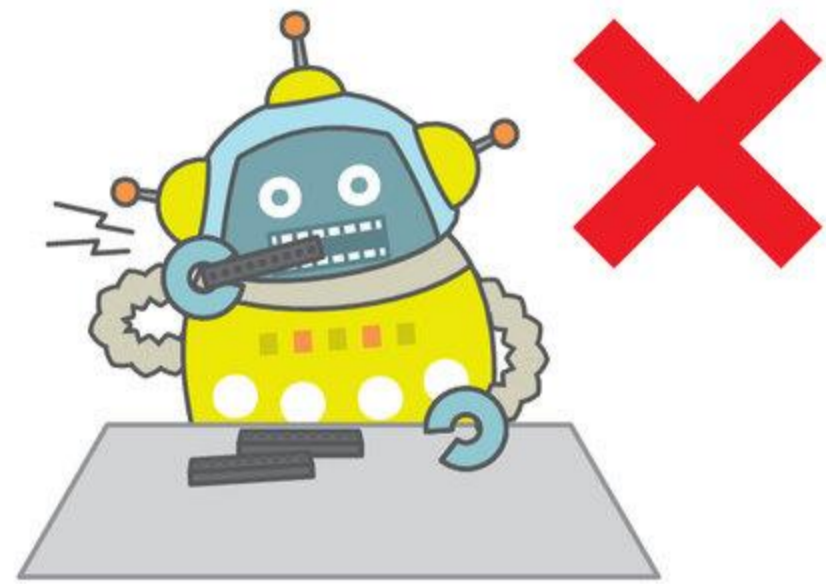

! ぶひんを きずつけない

でんきぶひんを はさみや かつたあ カッターなどで
きずついたり、ばあっ パーツで はさんだりしては
いけません (しゃしん 1)。

こおど や けえぶる コードや ケーブルは、おりまげたり、
ひっぱったりしては いけません。

ぶらぐ の めきさしは、ぶらぐぶぶんを
もって おこないましょう (しゃしん 2)。

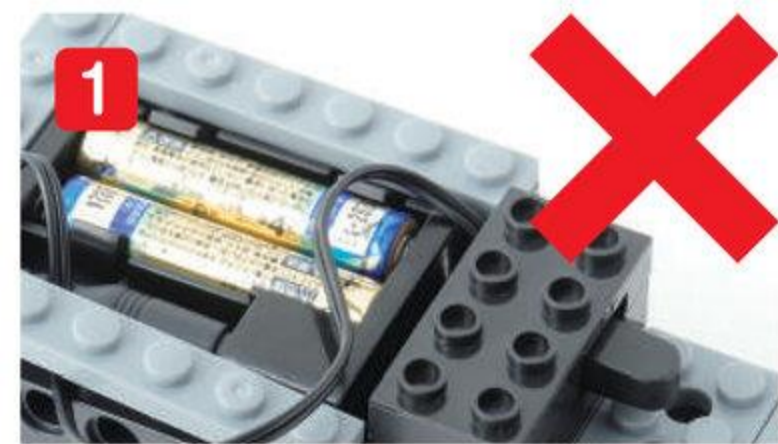

! あつい・におうとき、へんなおとが するとき

ろほっと ロボットを うごかしたときに、でんちや でんきぶひんが
あつくなったり、へんな においが したり、いつもと ちがうおとが
したばあいは、すぐに ろほっと ロボットを とめ、せんせいに しらせましょう。
ぬれたてで でんきぶひんを さわってはいけません。

もくじ

だい 1 かい

ろぼっとの ぶんかい	3	10ぶん
かんがえてみよう	3~4	
きょうの パーツ	5	12ぶん
きょうの よてい	6	
くみたて		
1. ふね (まんなか)	7~27	60ぶん
2. ふね (まえ)	28~40	
3. ふね (うしろ)	41~50	
ろぼっとを うごかそう	51	
くいす	52	3ぶん
かたづけ		5ぶん

ふるっく
ブロックはずし



つかうと べんりだよ

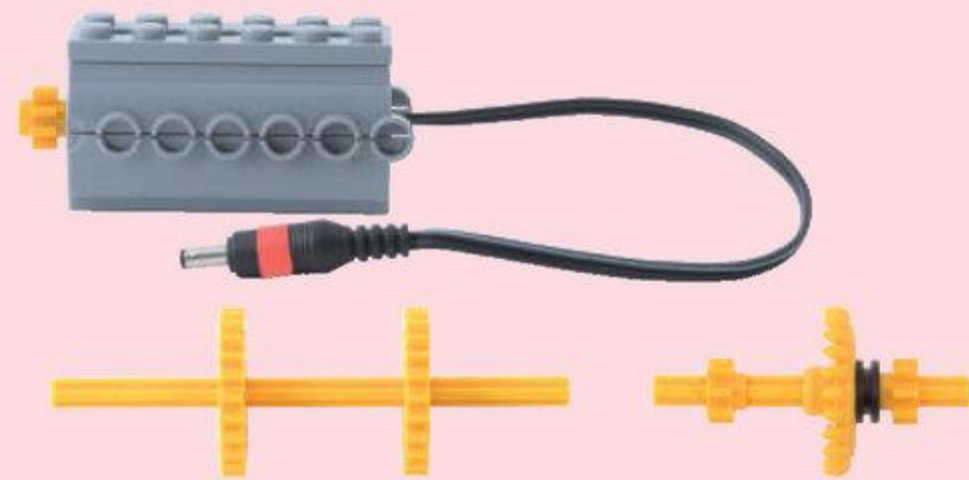

このセットは くずさないでね! またつかうよ



かんがえてみよう

めやす 5 ぶん



ふねは どうやって すすんでいるかな?





みずをおしてすすんでいるよ。



お お る
オールをこいでみずをうしろにおすと
はんどうでふねはまえにすすむよ。

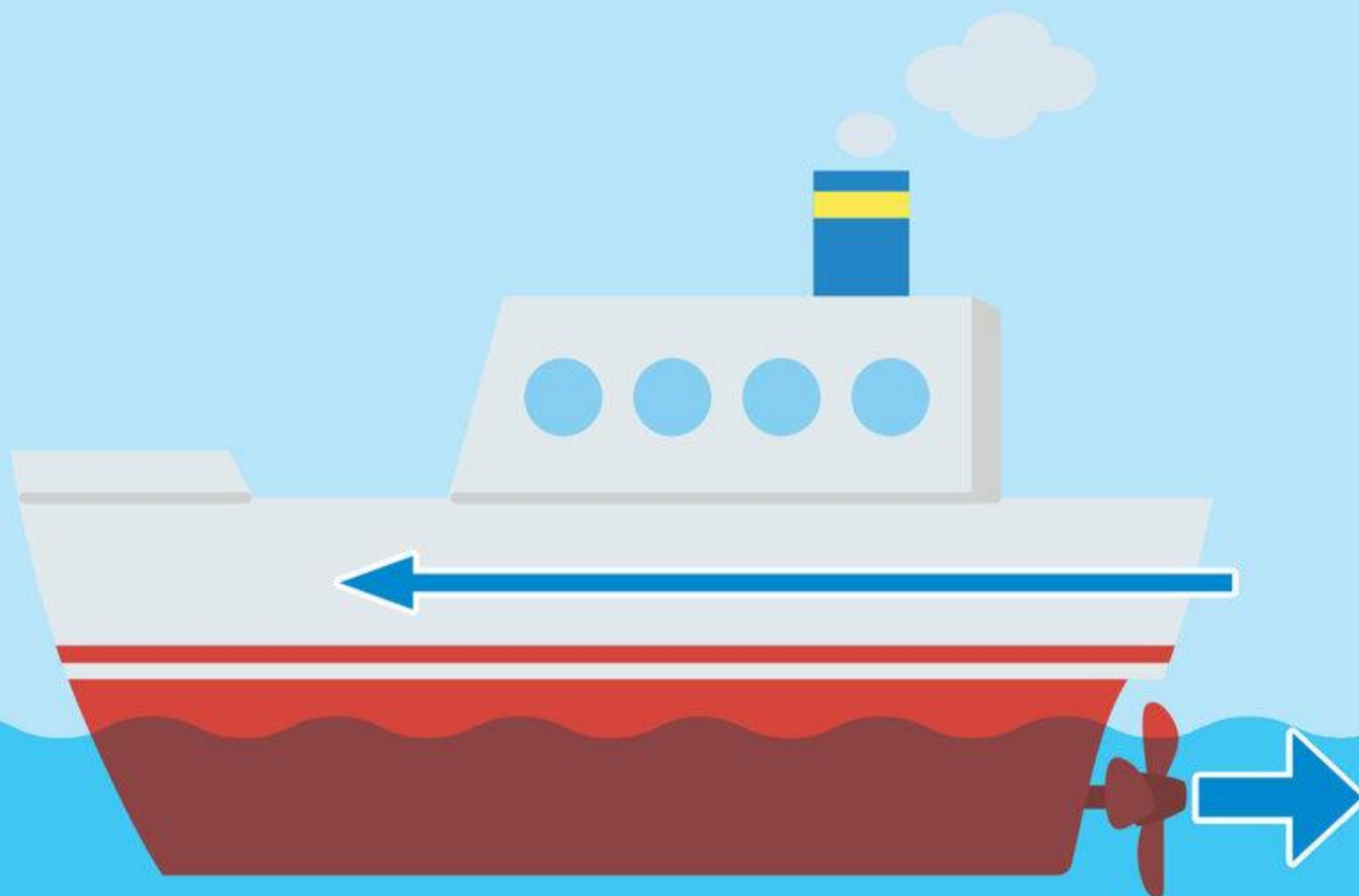

す くり ゅ う
「スクリュー」でみずをおすふねもあるよ。

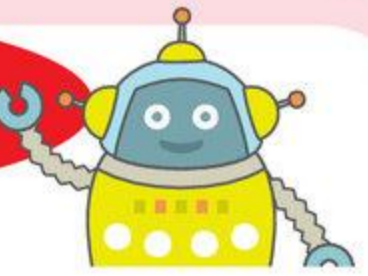

めやす **5** ふん

しゃふとじょいんと
シャフトジョイント

あなしゃふとじょいんと
アナシャフトジョイント

パーツをみつけよう



とくちょう

しゃふとじょいんと
シャフトジョイント



あな
+のかたちのアナ

あなしゃふとじょいんと
アナシャフトジョイント



あな
○のかたちのアナ

マスターしよう

あなしゃふと
アナにシャフトをさしてみよう。なんぼんさせるかな？

しゃふとじょいんとあな
●シャフトジョイントはアナがつながっていないよ。

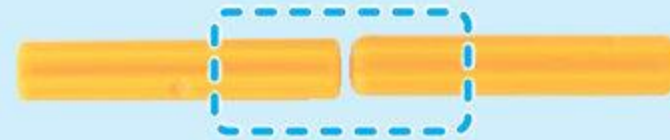

あなしゃふとじょいんと
●アナシャフトジョイントは
つながっているアナとつながっていないアナがあるよ。

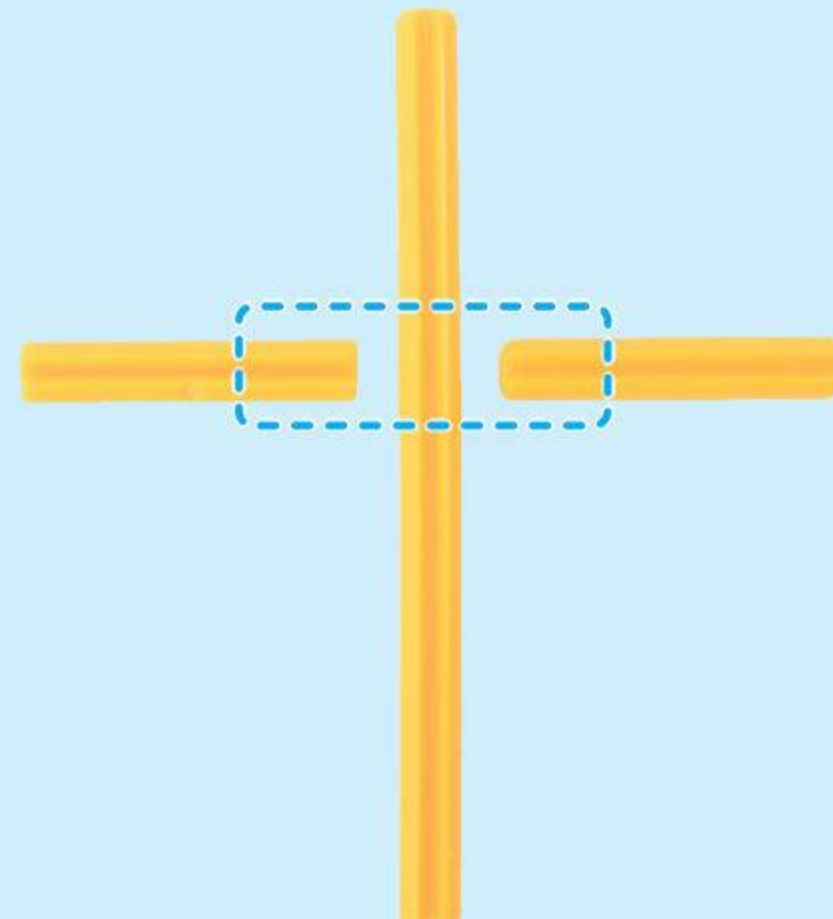
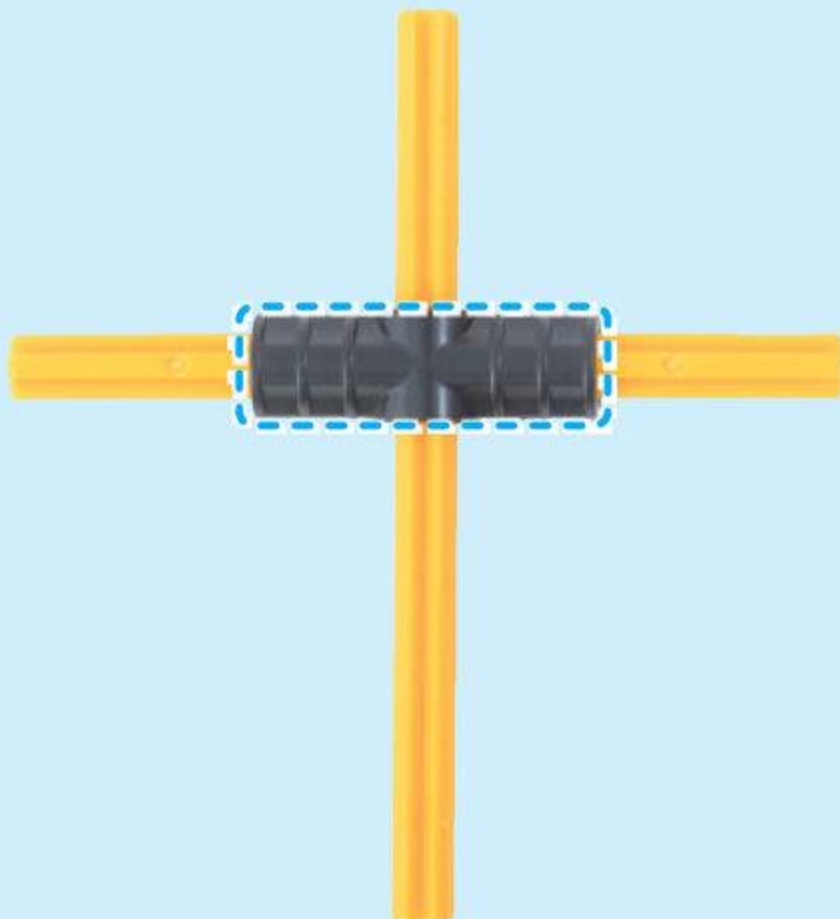

きょうの よてい

めやす 2 ふん

このじゅんばんでつくるよ!

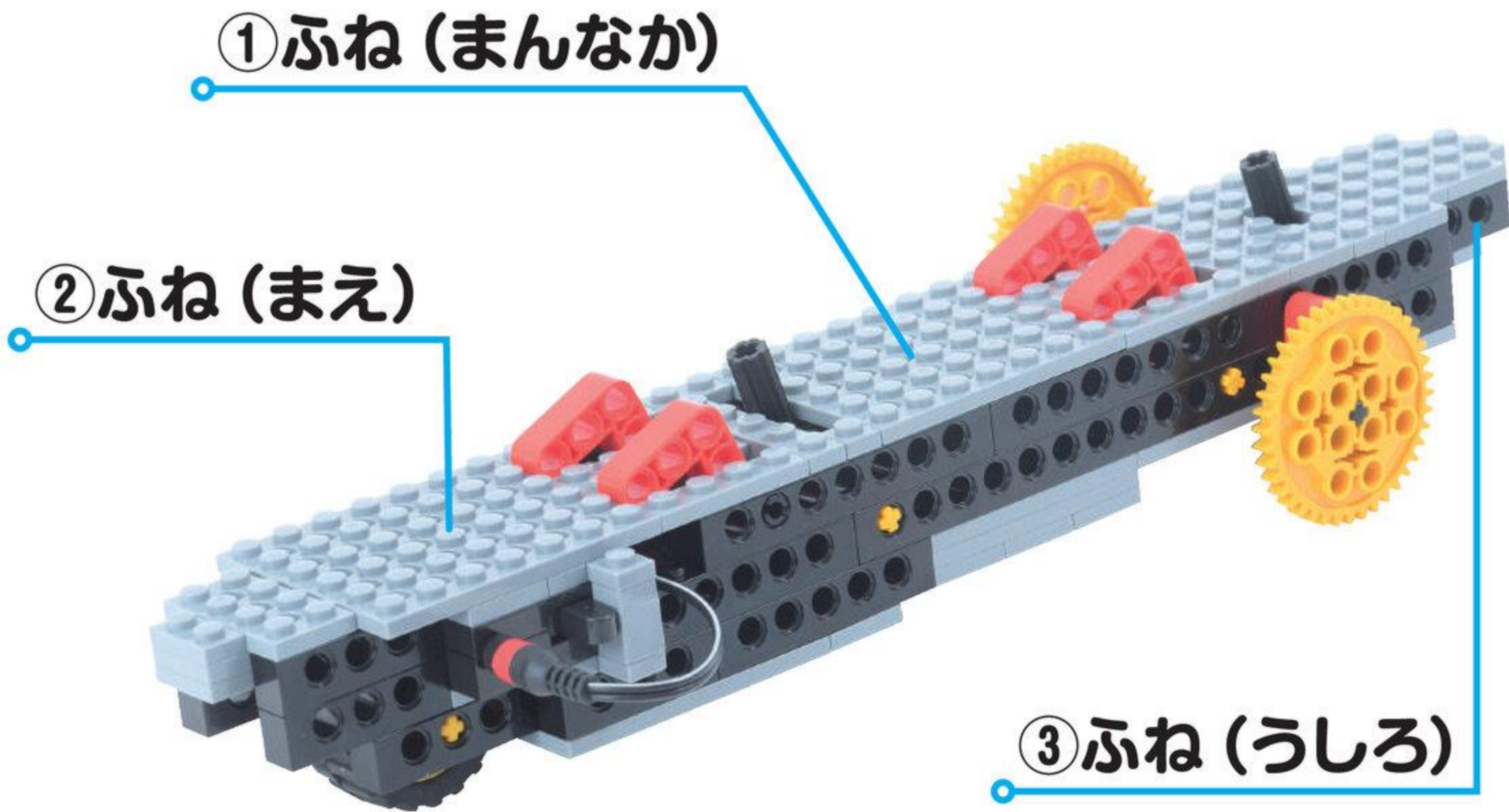

①ふね (まんなか)



②ふね (まえ)

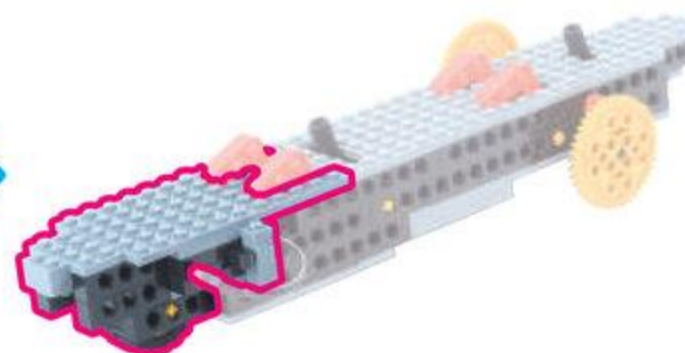

③ふね (うしろ)



1 ふね (まんなか)

めやす 25 ぶん



ほそぶれえとろくぼち
細プレート 6 ポチ **2** こ



ふとぶれえとろくぼち
太プレート 6 ポチ **3** こ



1

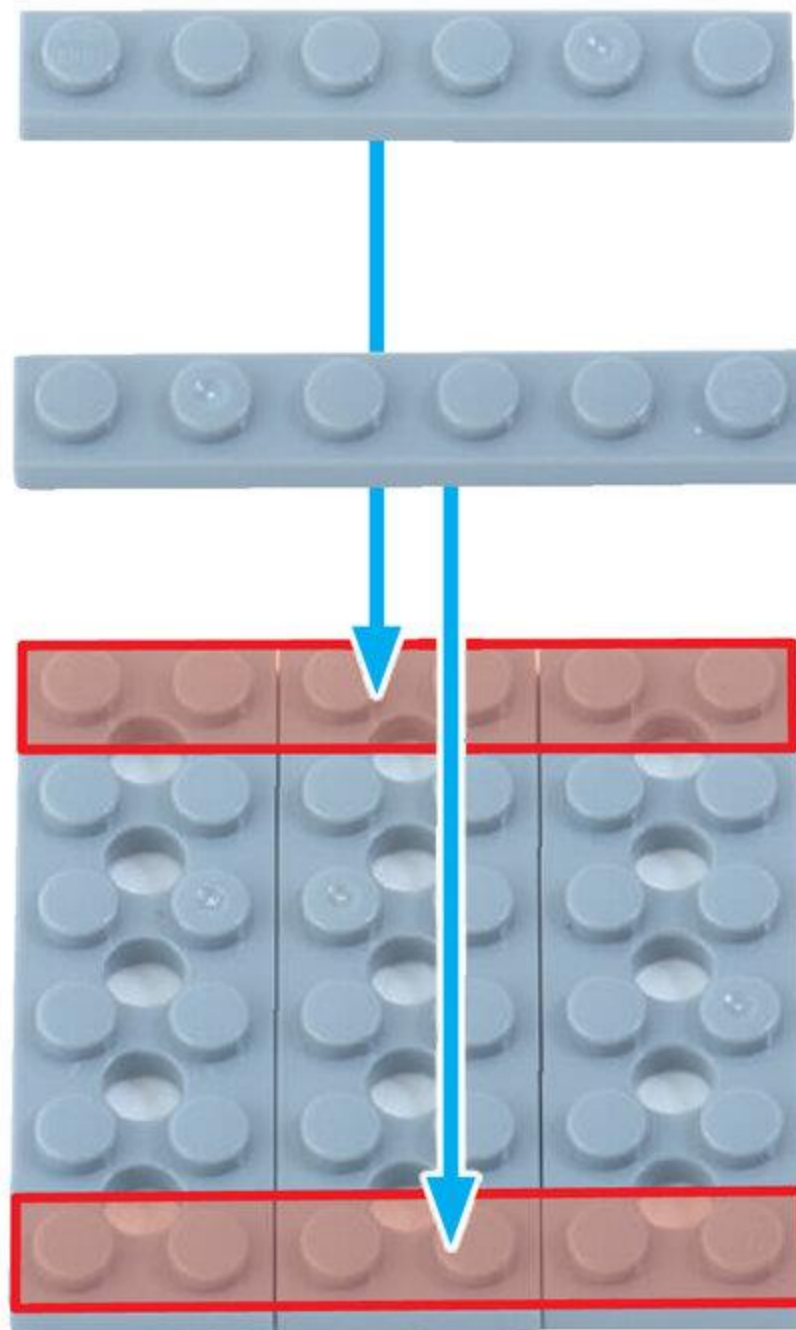

びいむじゅうん ぼち
ビーム 14 ポチ 1こ

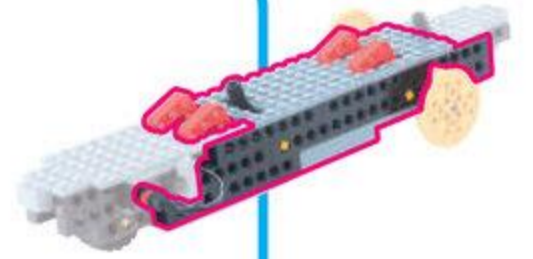

びいむん ぼち
ビーム 4 ポチ 1こ



ほそぶれえとろく ぼち
細プレート 6 ポチ 2こ



ほそぶれえとに ぼち
細プレート 2 ポチ 1こ



2

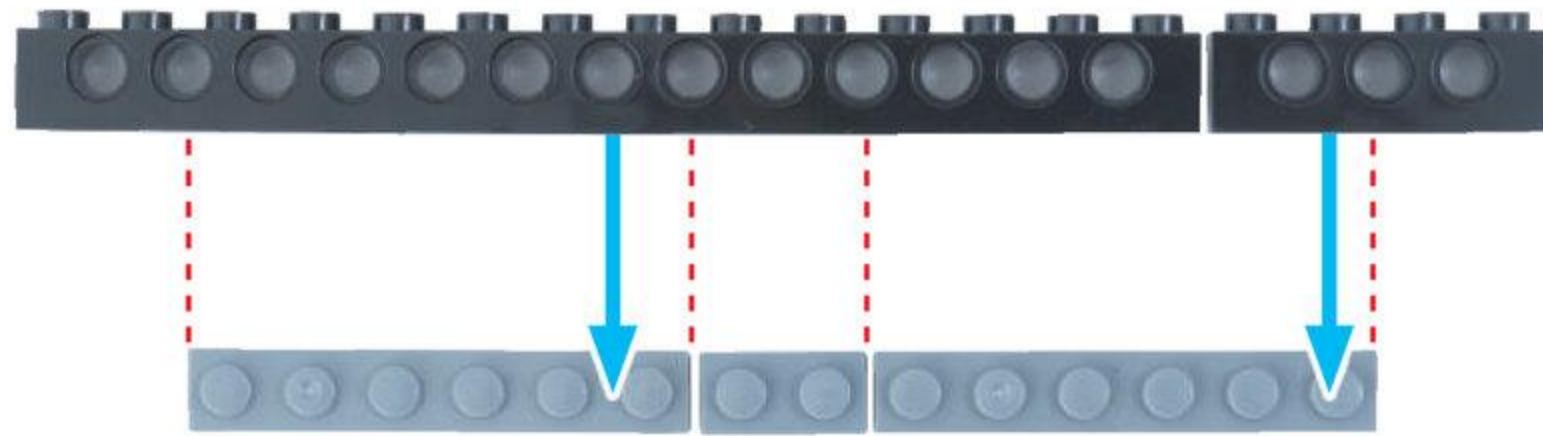

びいむ ぼち
ビームが 2ポチぶん はみでるよ

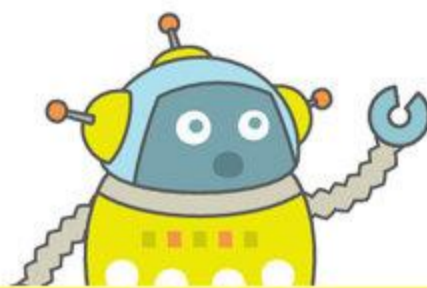

びいむはちほち
ビーム 8 ポチ 1こ



びいむよんほち
ビーム 4 ポチ 1こ



びいむろくほち
ビーム 6 ポチ 1こ



3

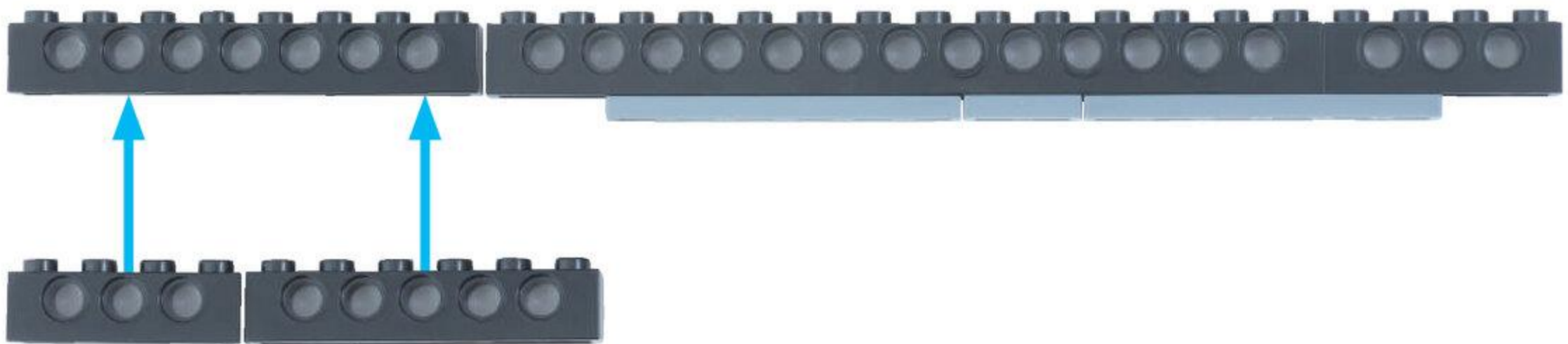

4

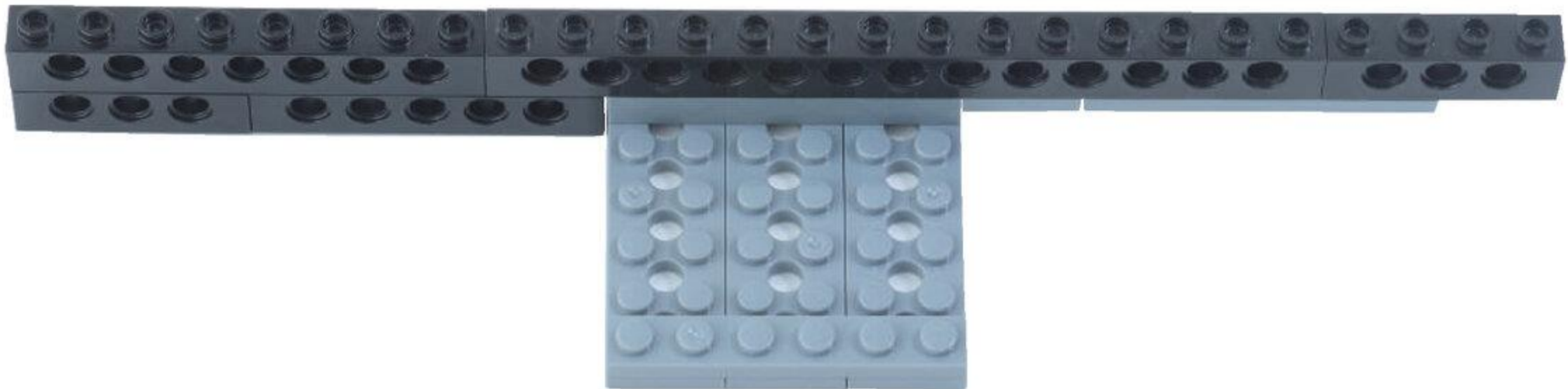
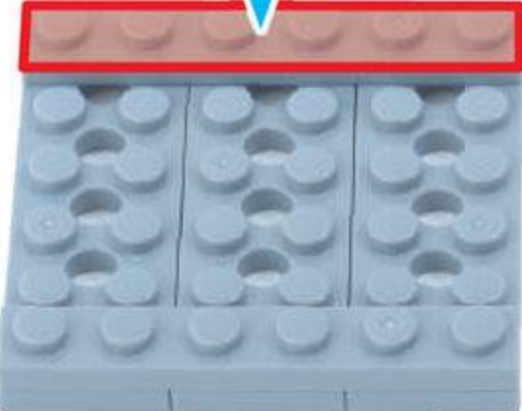
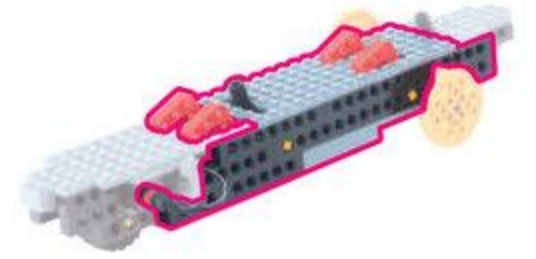

ぶっしゅ
ブッシュ 2こ



しゃふと 3く ぼち
シャフト 6ポチ 1こ



ていじょいんと
T ジョイント 1こ



しゃふとじょいんと
シャフトジョイント 1こ



くろしゃふと いってんご ぼち
黒シャフト 1.5ポチ 1こ



○ みじかい
× ながい



5

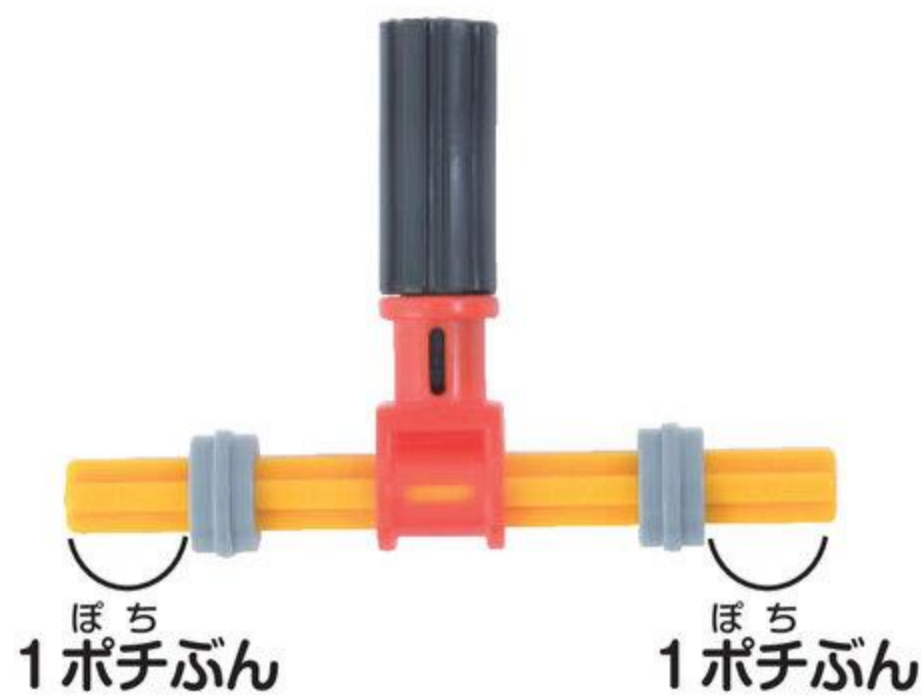
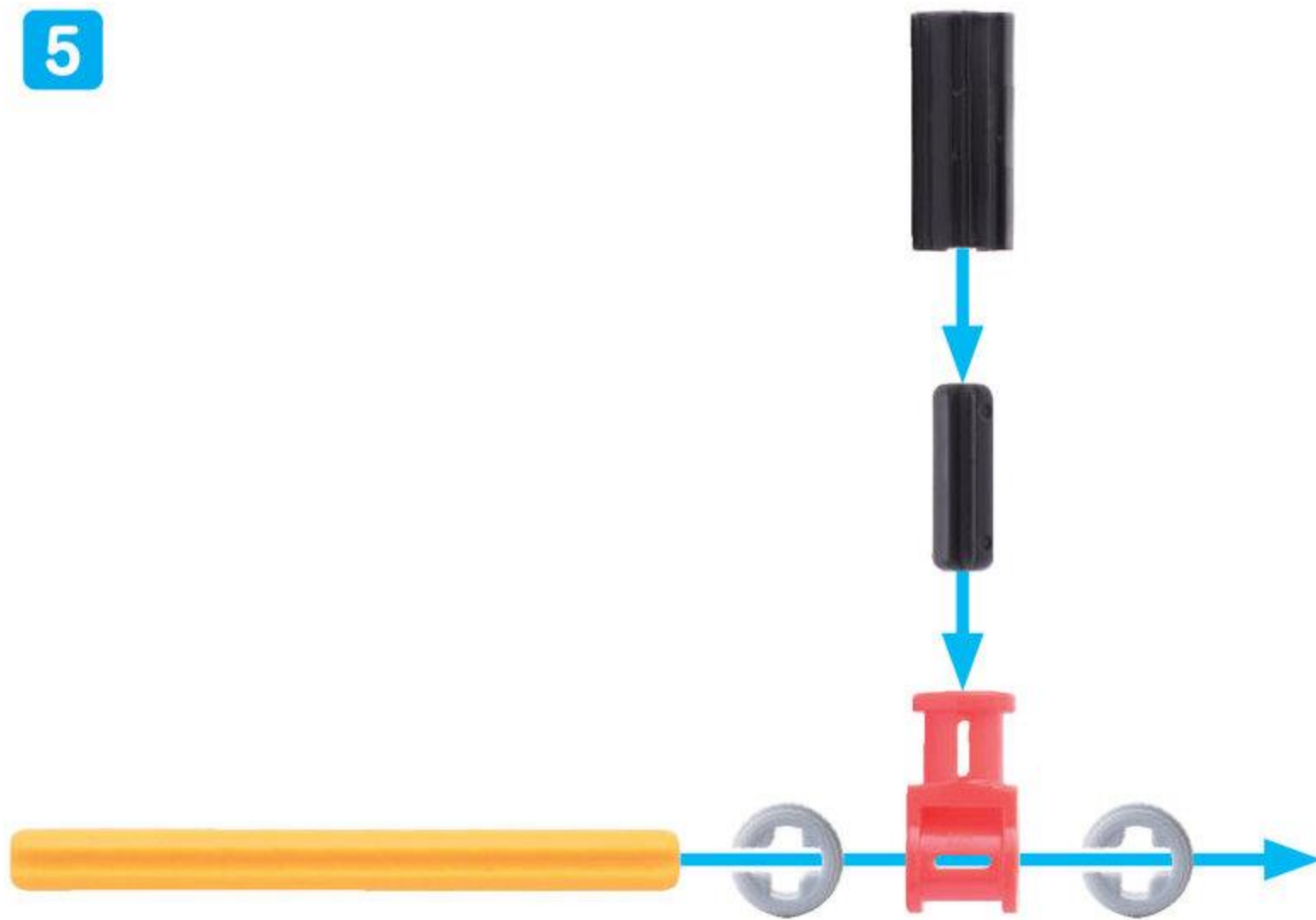

しゃふと はち ぼち
シャフト 8 ポチ 1こ

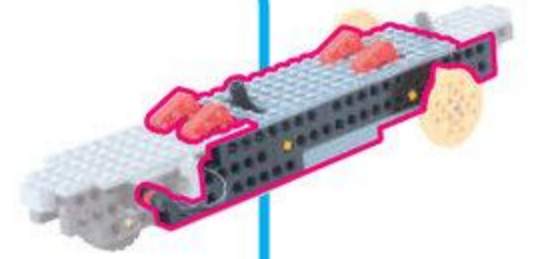

ぎあ えむ
ギア M うす 2こ

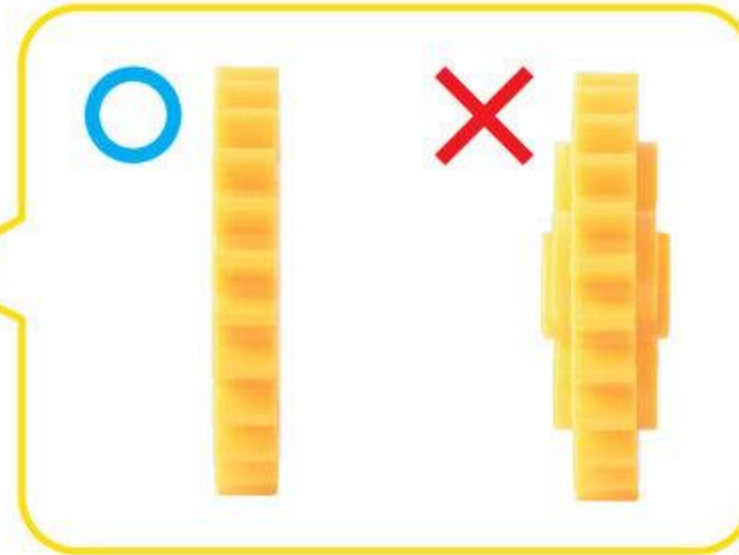
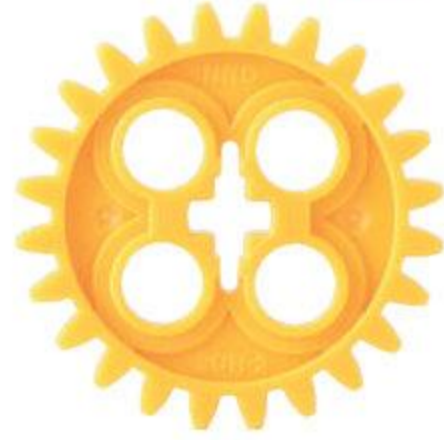

6

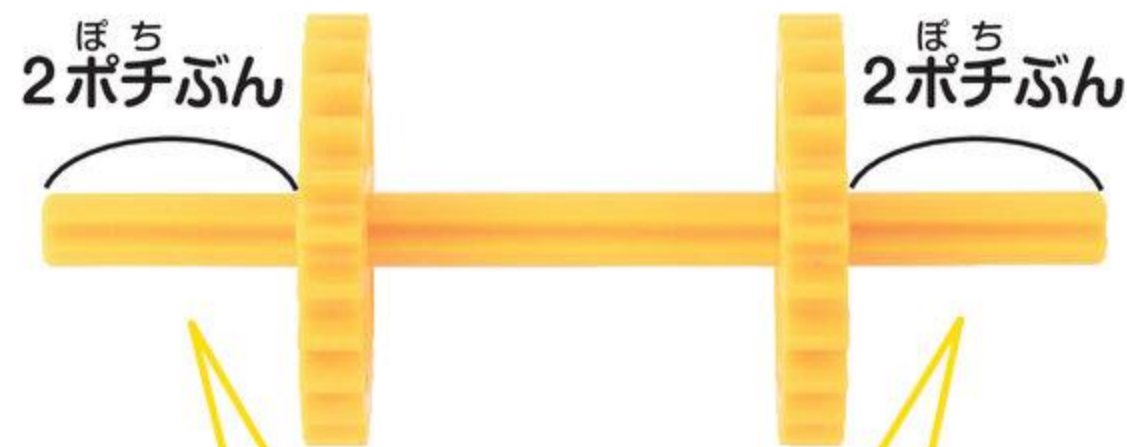

たてにかさねた ^{びいむ} ビームをつかってあけることもできるよ!

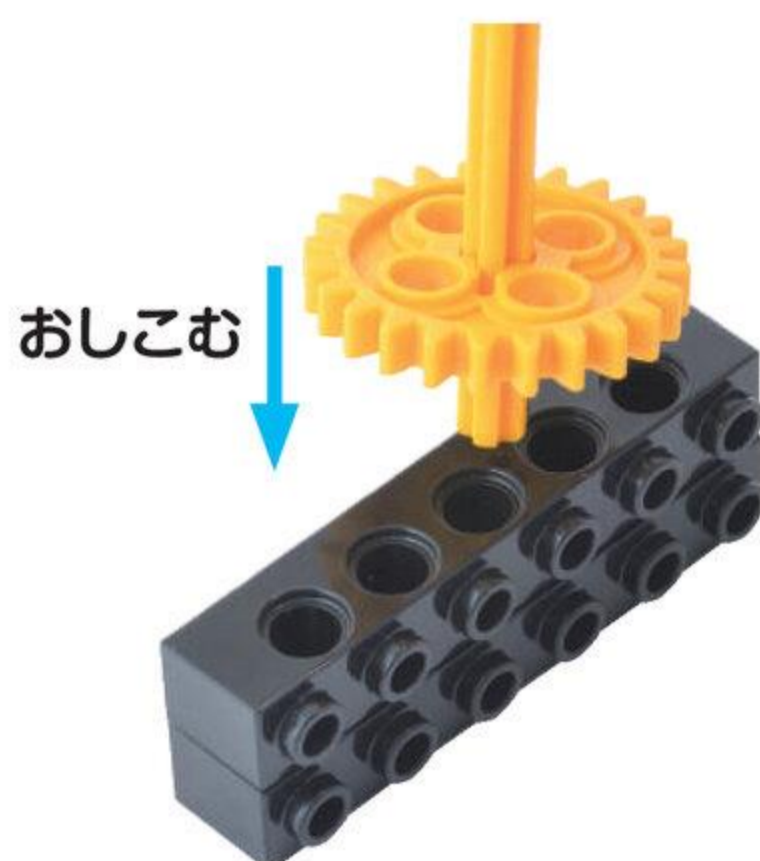

ぎあせつと
ギアセット



7

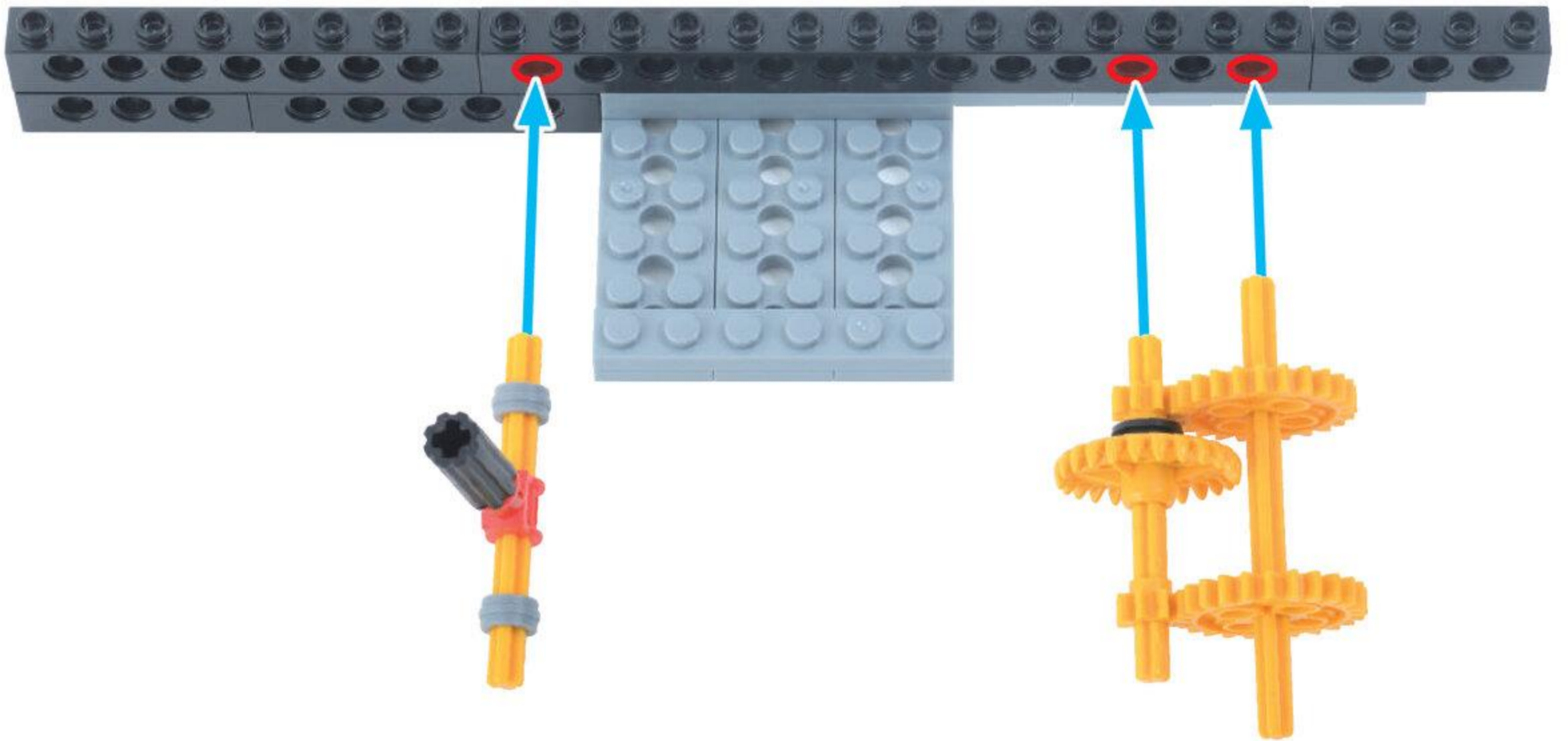

もおたあせつと
モーターセット



8

はずす

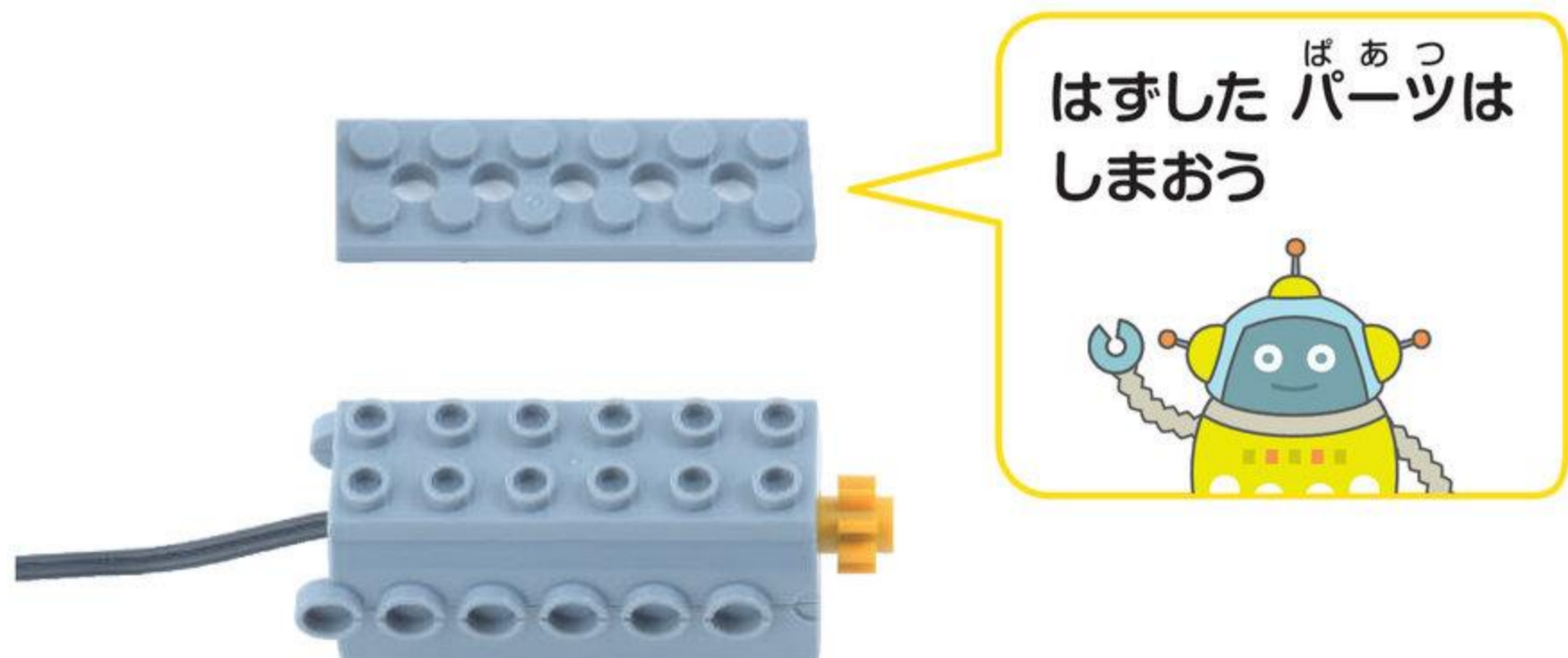
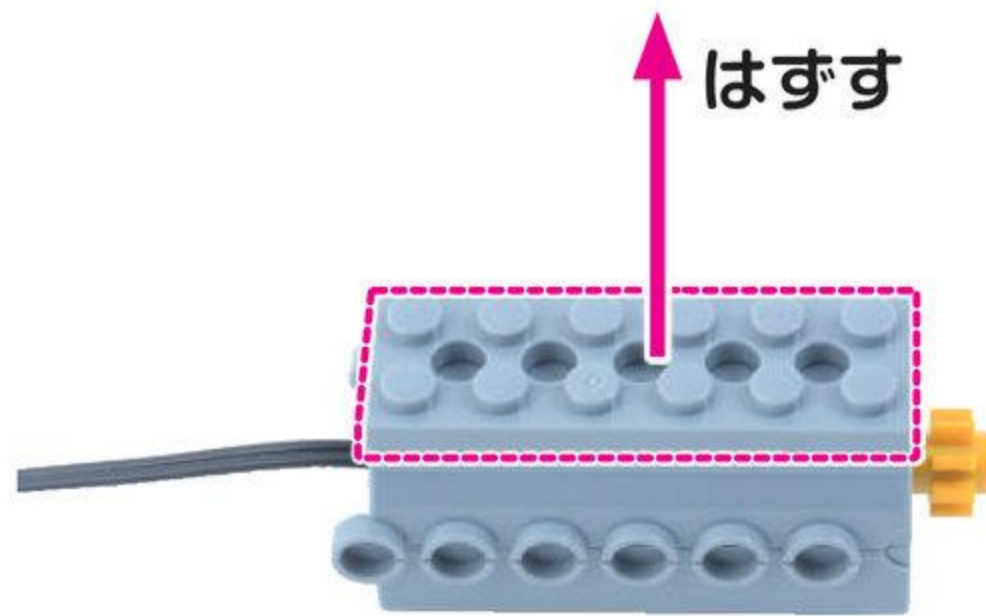

9

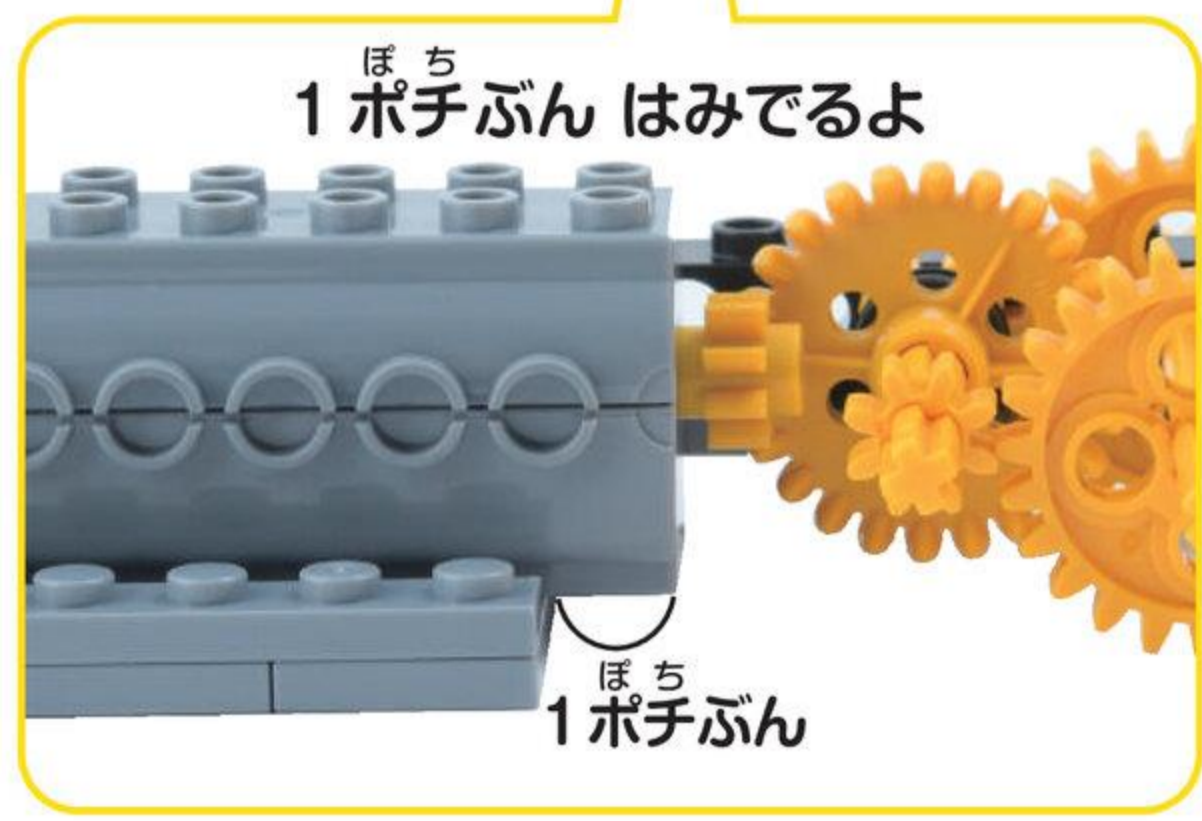
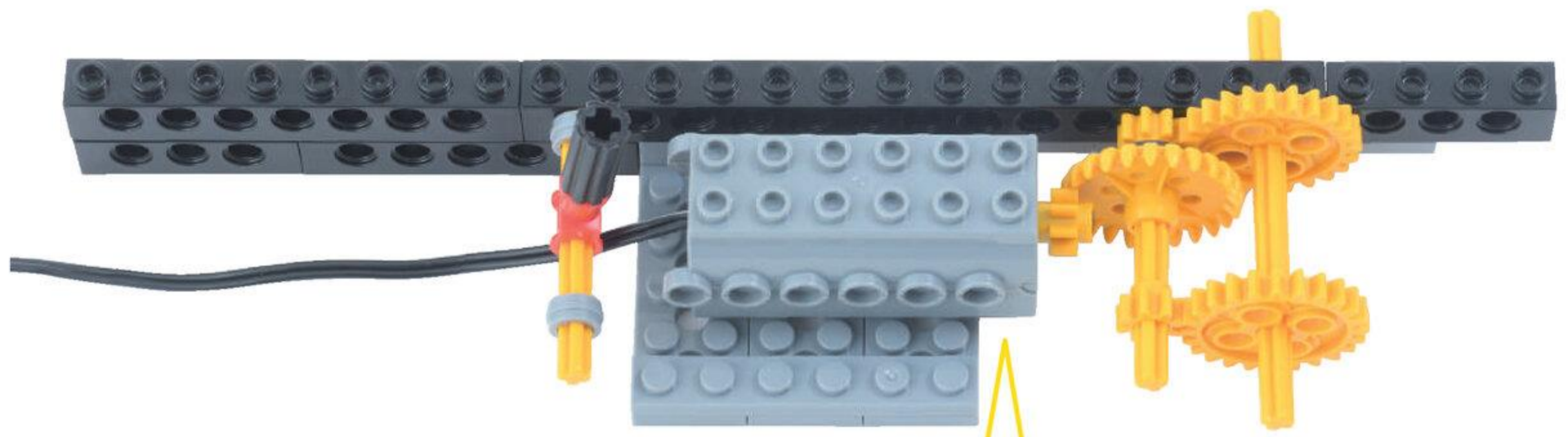
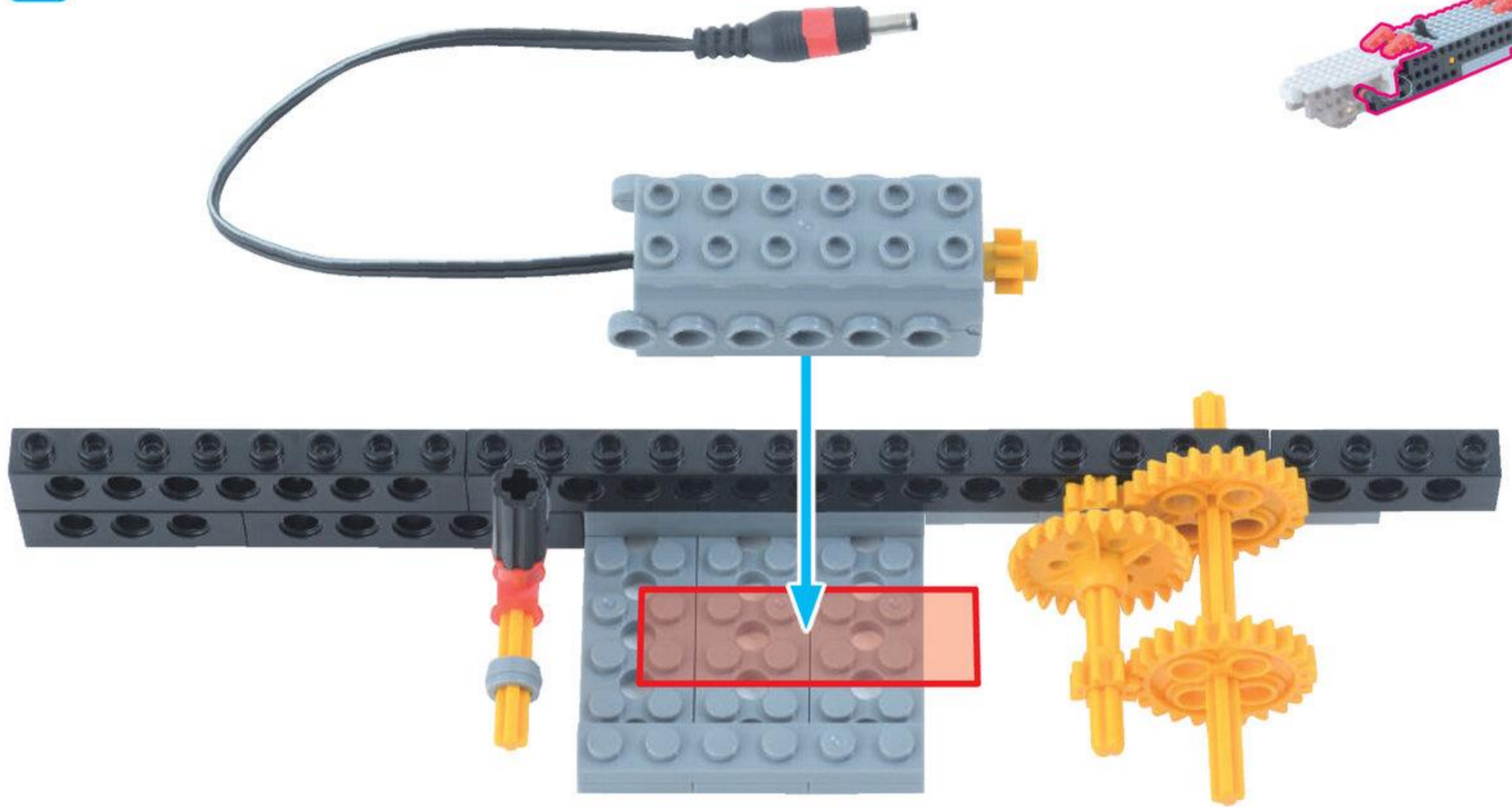

びいむじゅうよん ぽち
 ビーム 14 ポチ 1こ

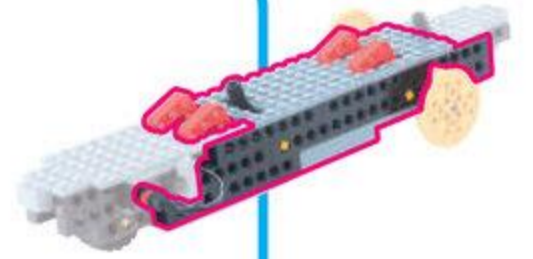

びいむよん ぽち
 ビーム 4 ポチ 1こ



びいむろく ぽち
 ビーム 6 ポチ 1こ



ほそぶれえとろく ぽち
 細プレート 6 ポチ 2こ



ほそぶれえとに ぽち
 細プレート 2 ポチ 1こ



10

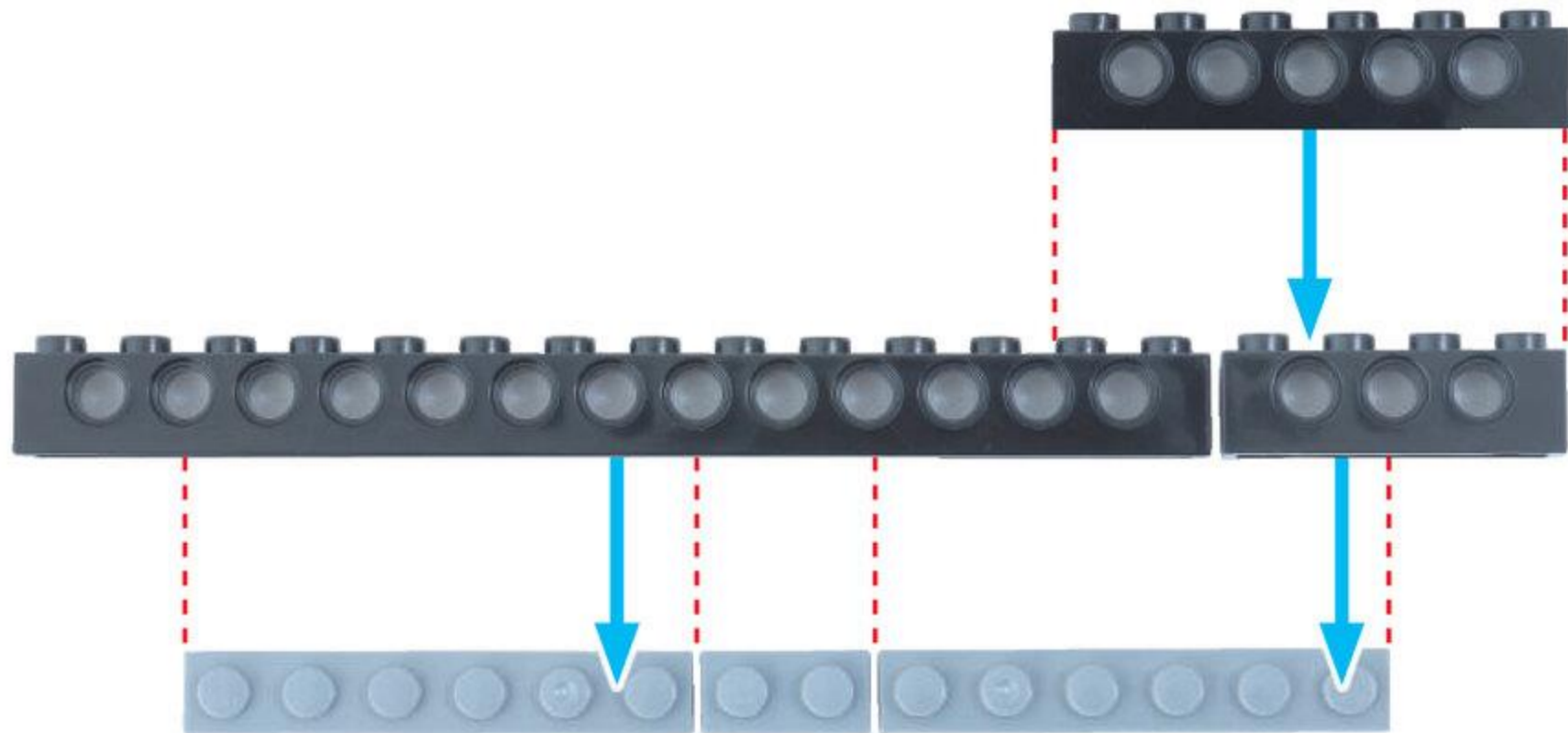

ぽち
 2ポチぶん

ぽち
 2ポチぶん

びいむ ぽち
 ビームが 2ポチぶん はみでるよ

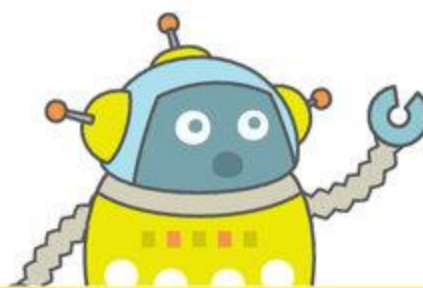

びいむろくほち
ビーム 6 ポチ 2こ



びいむよんほち
ビーム 4 ポチ 1こ



11

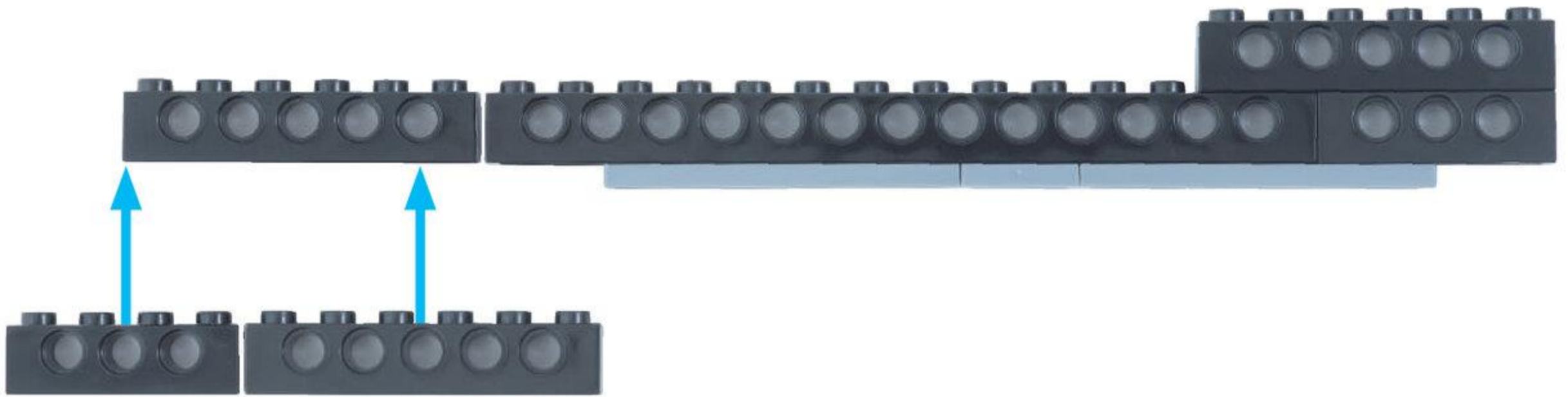

12

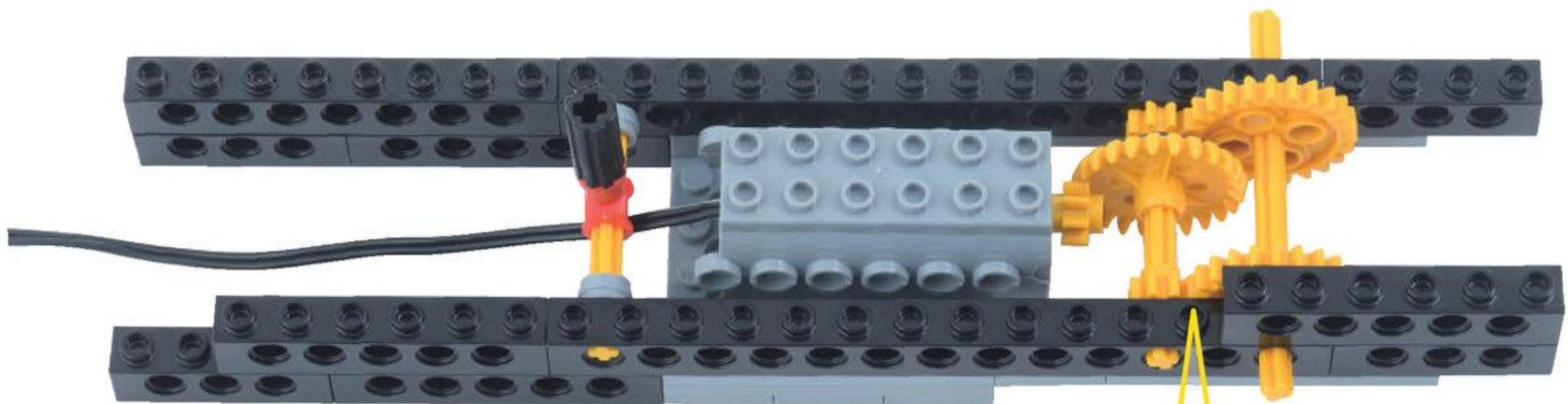
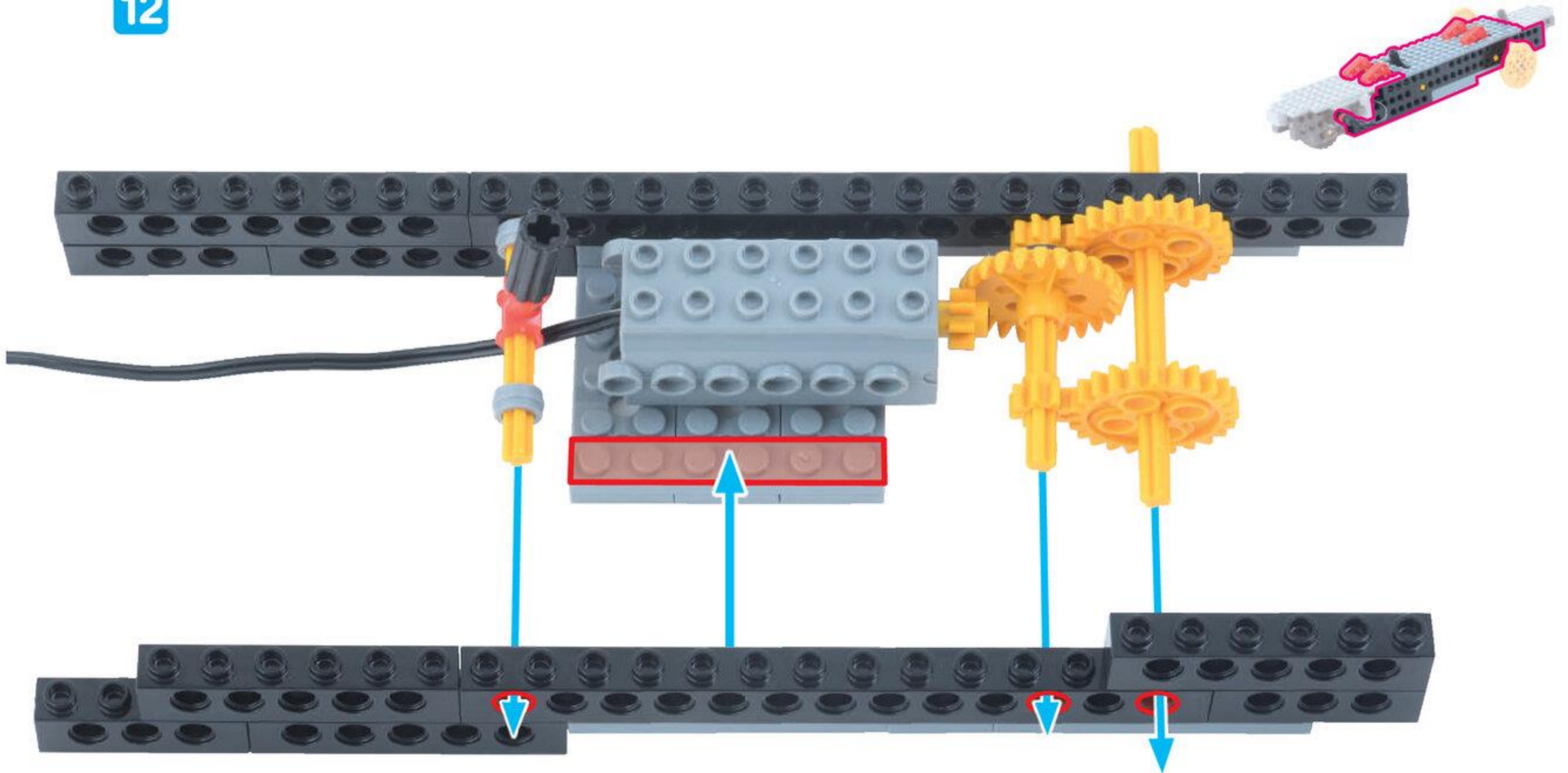

ギアが かみあっているか
たしかめよう

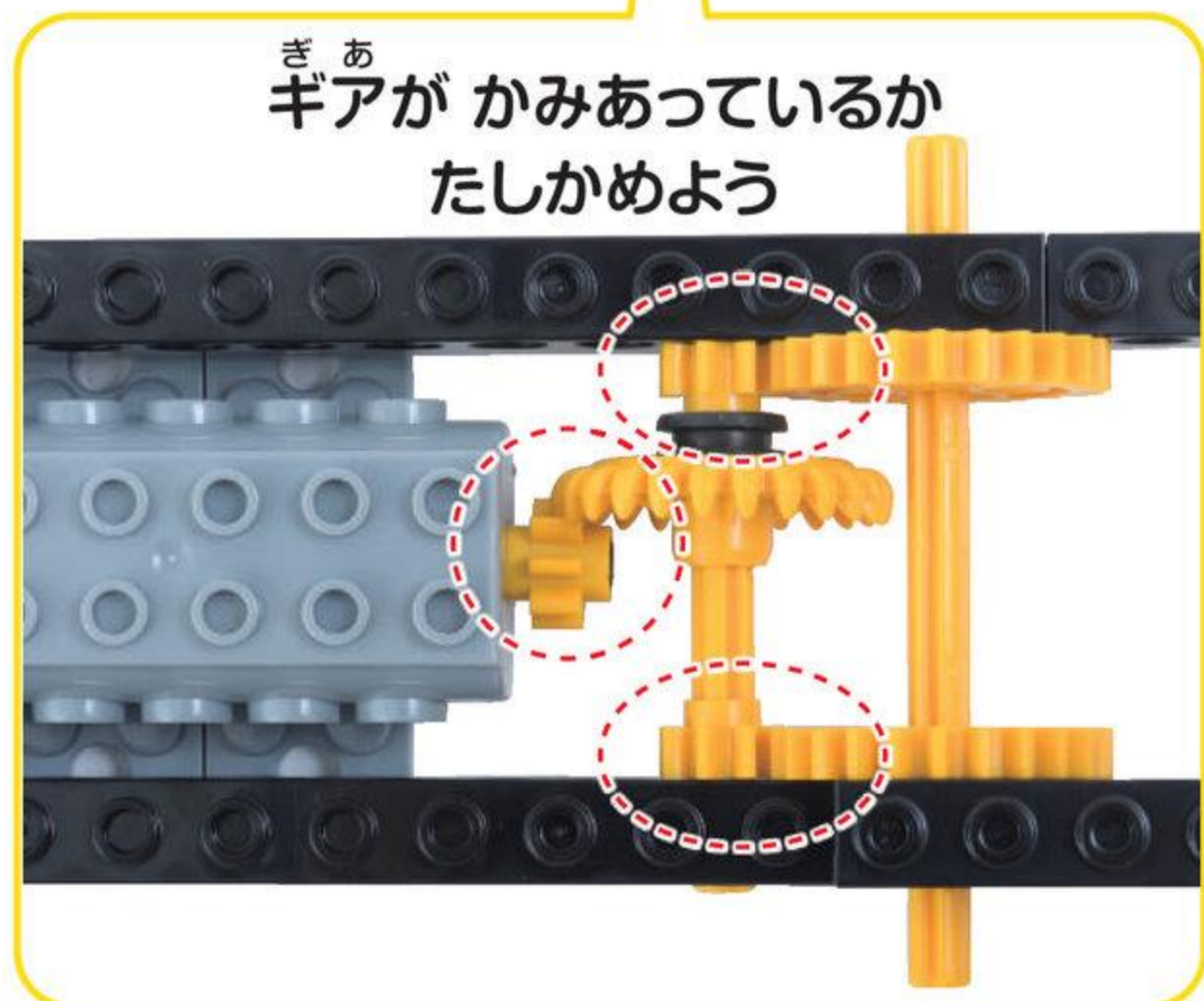



びいむじゅうよんほち
 ビーム 14 ポチ 2こ



へぐえす
 ペグ S 2こ



えろつど
 L ロッド 2こ

13

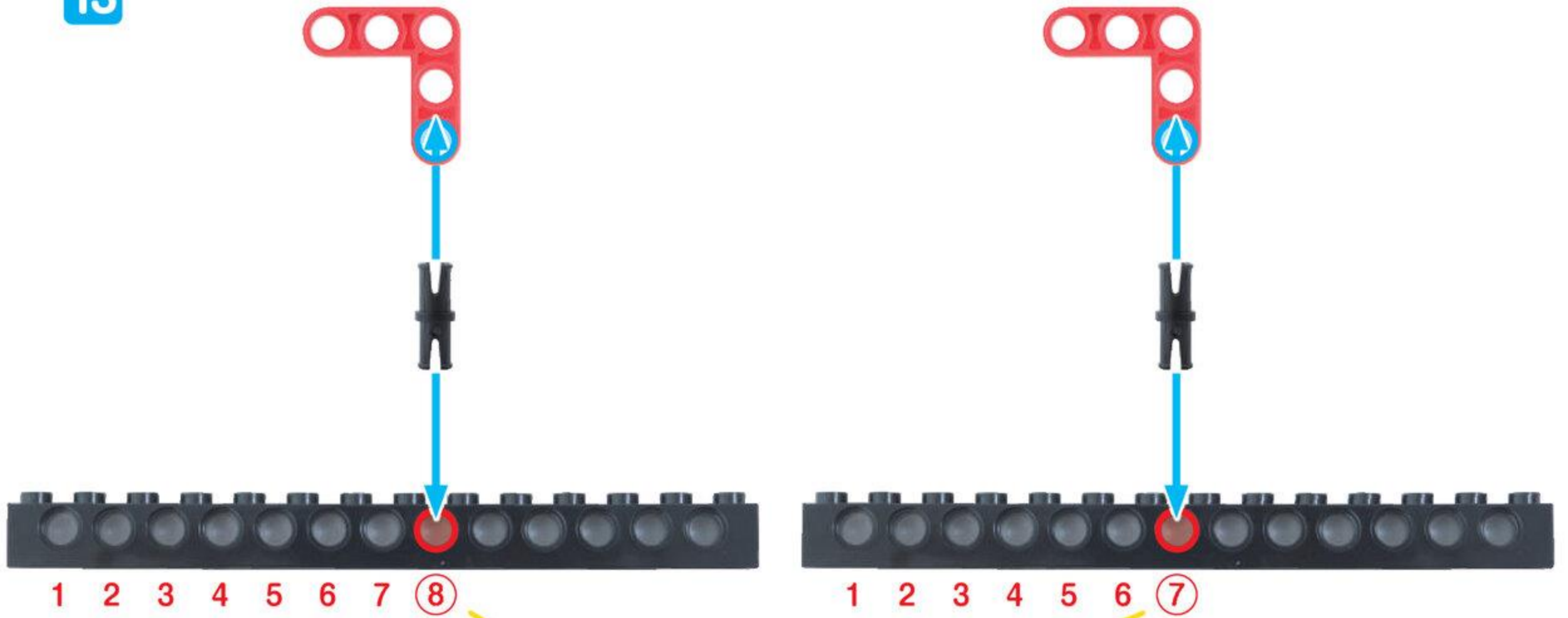

あなた
 さしこむ アナのちがいに
 ちゅういしよう



14

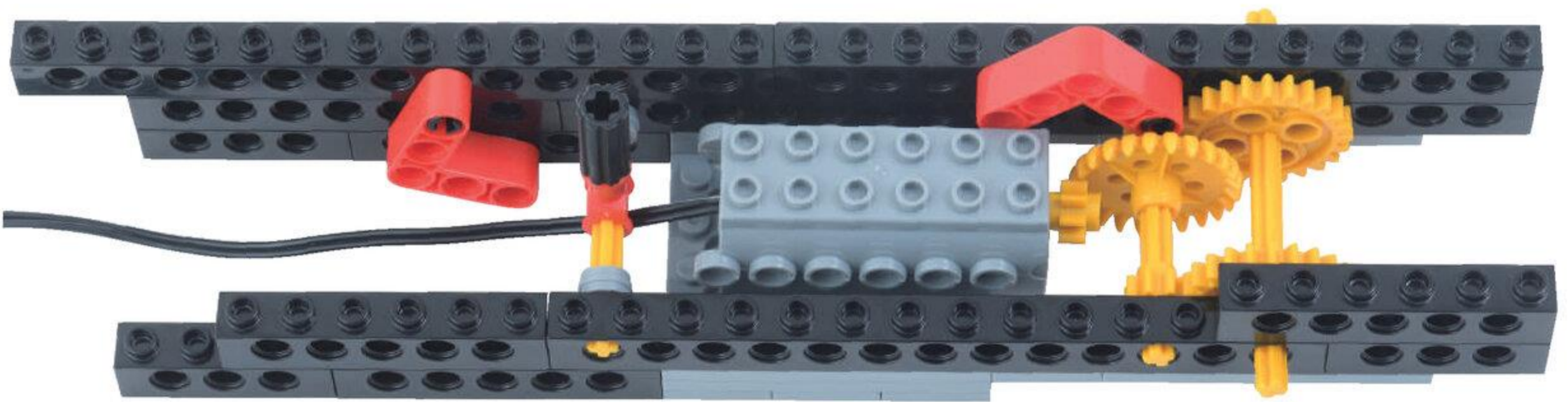
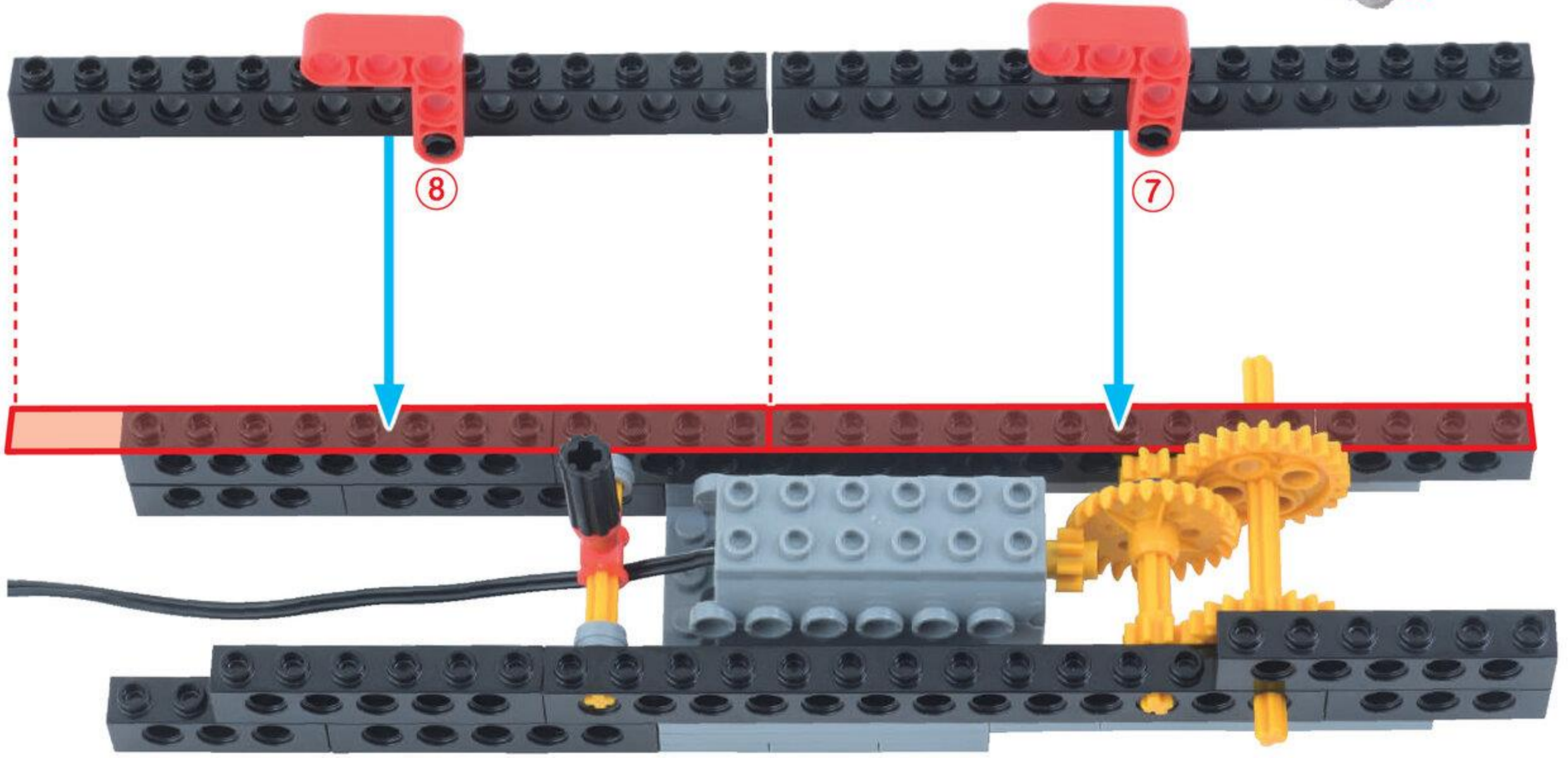
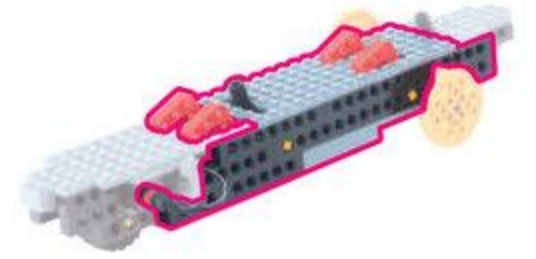

びいむはちぼち
ビーム8ポチ 2こ

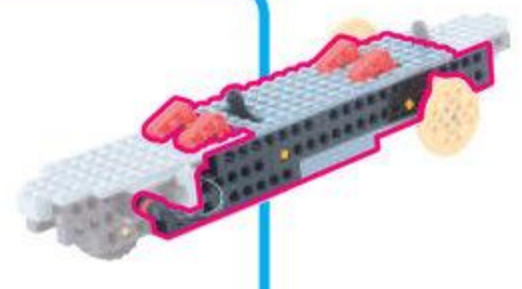

ぺぐえす
ペグS 2こ



えるろっど
Lロッド 2こ



15

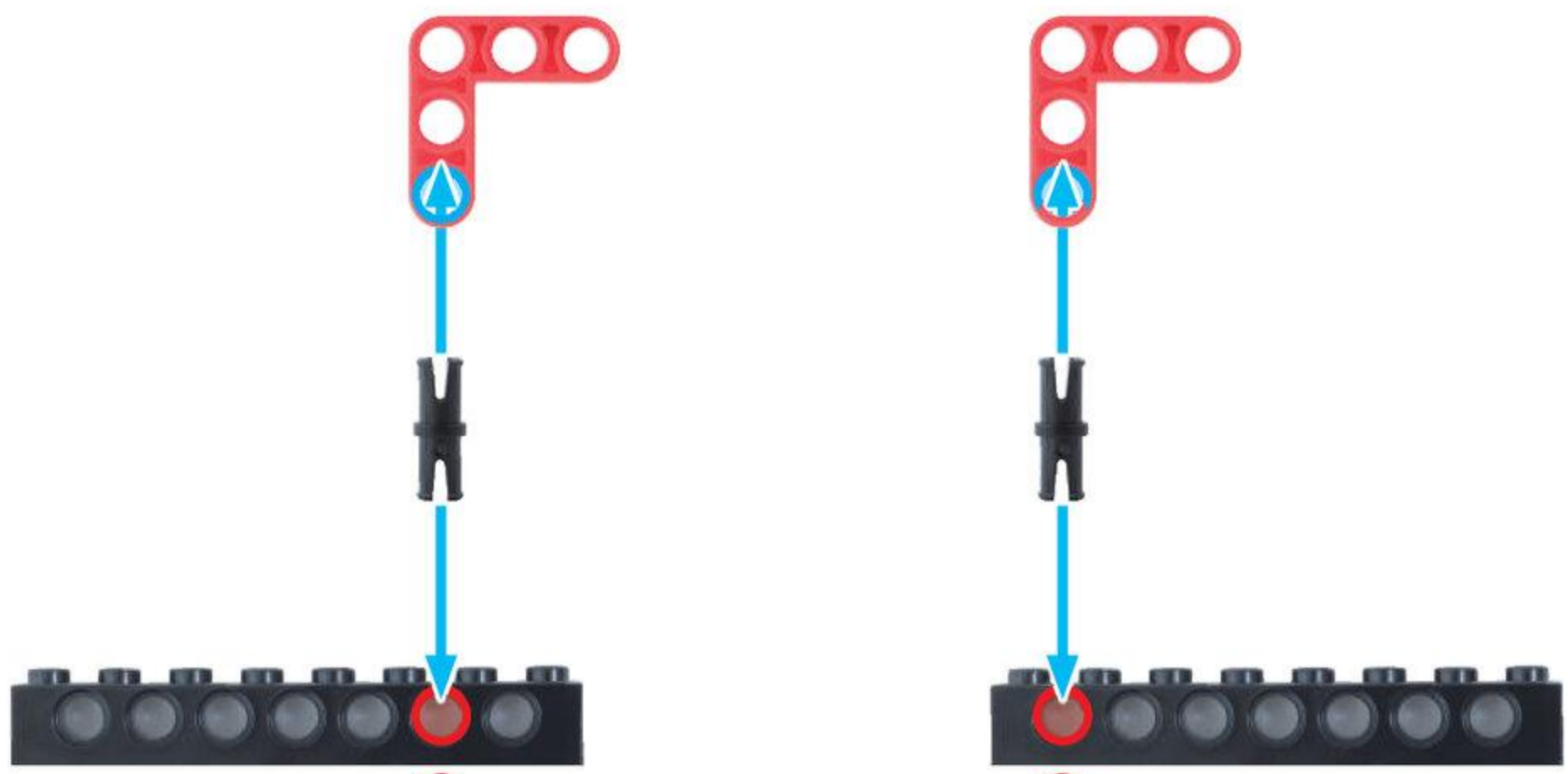

あなた
さしこむ アナのちがいに
ちゅういしよう

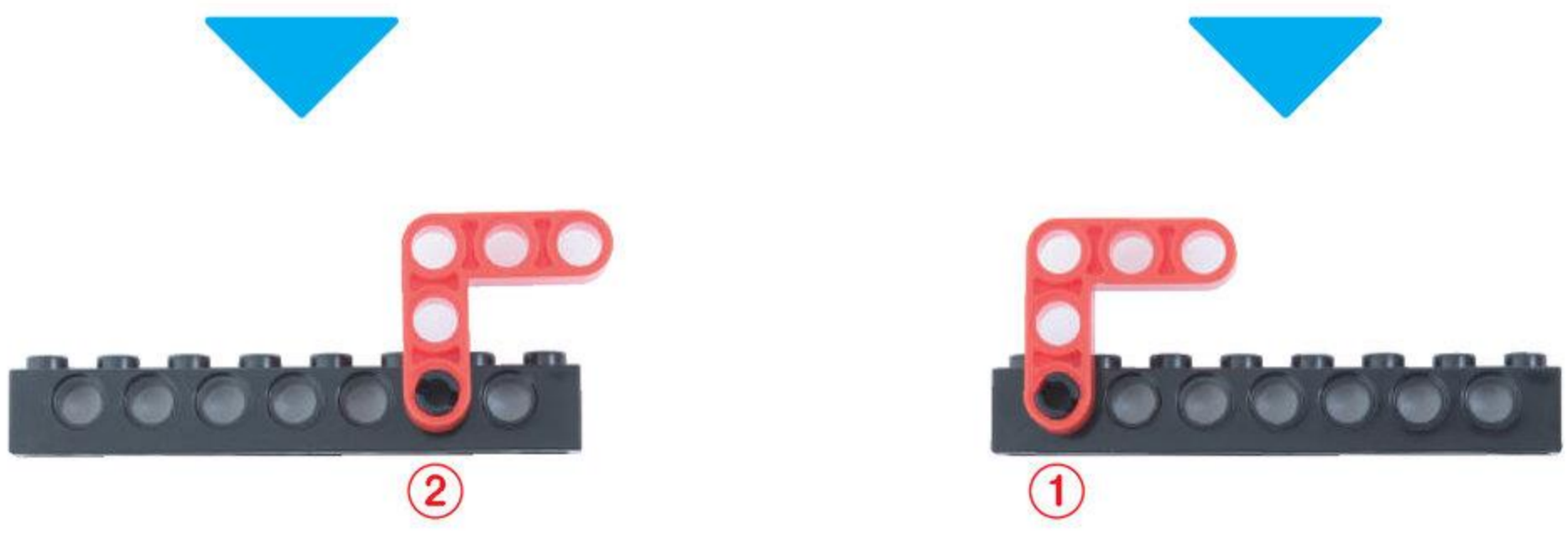

16

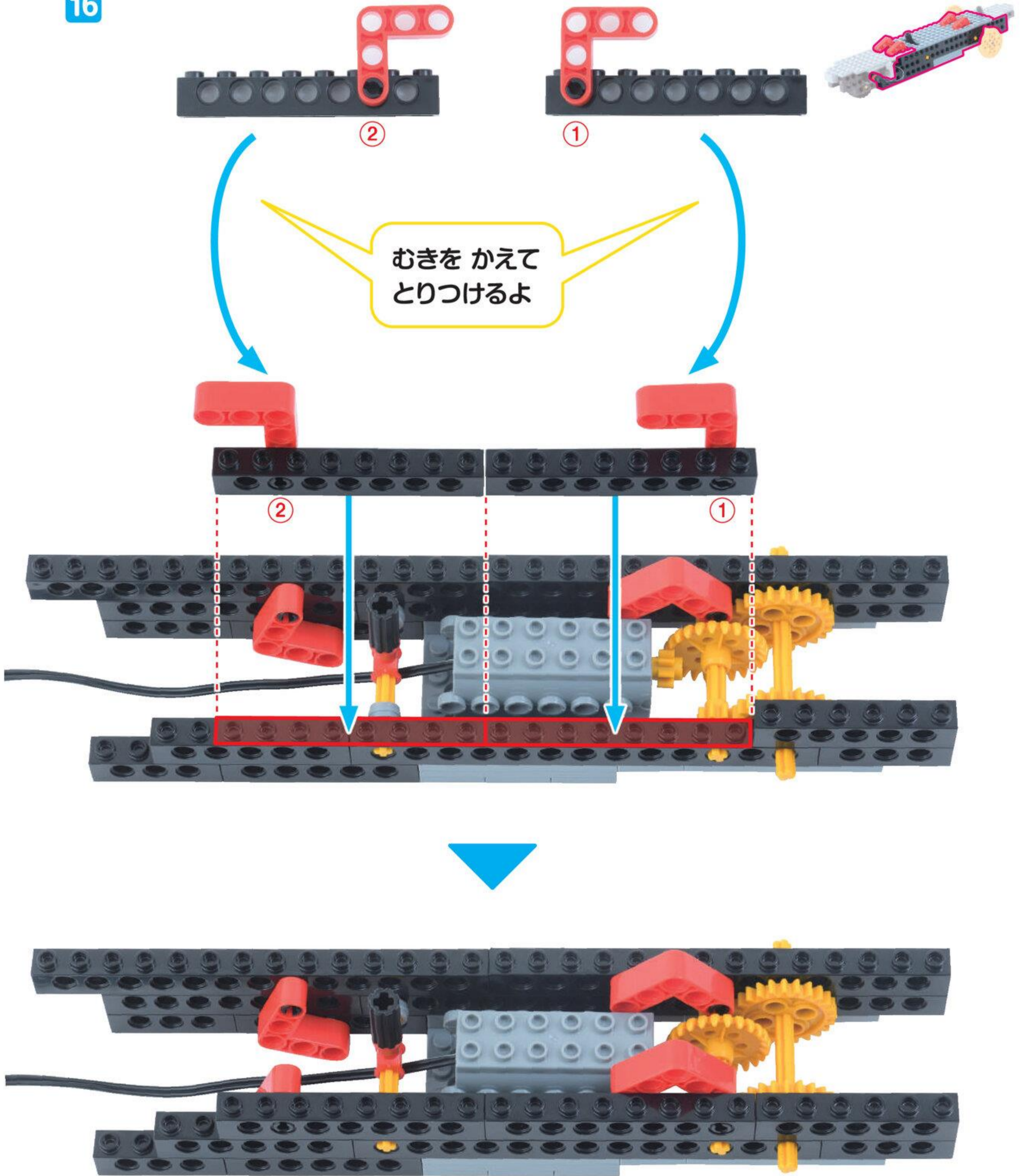

えろっど
L ロッドは だい2かいで
こどもとおとなの ^{ひざ}ヒザになるよ

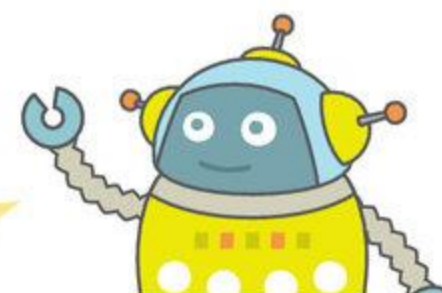

ふとぶれえとはちほち
太プレート 8 ポチ 1 こ



17

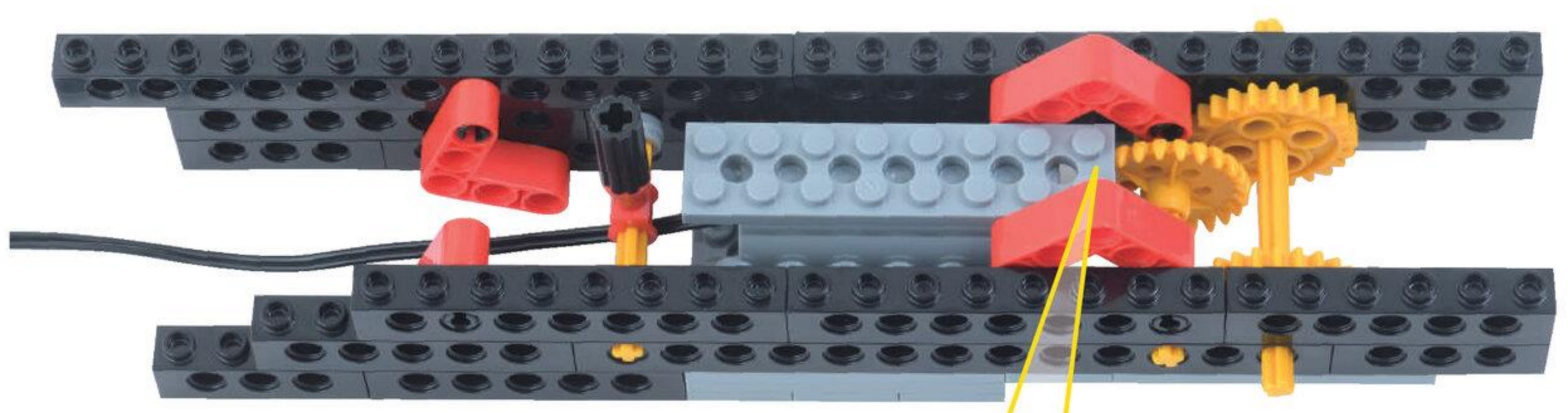
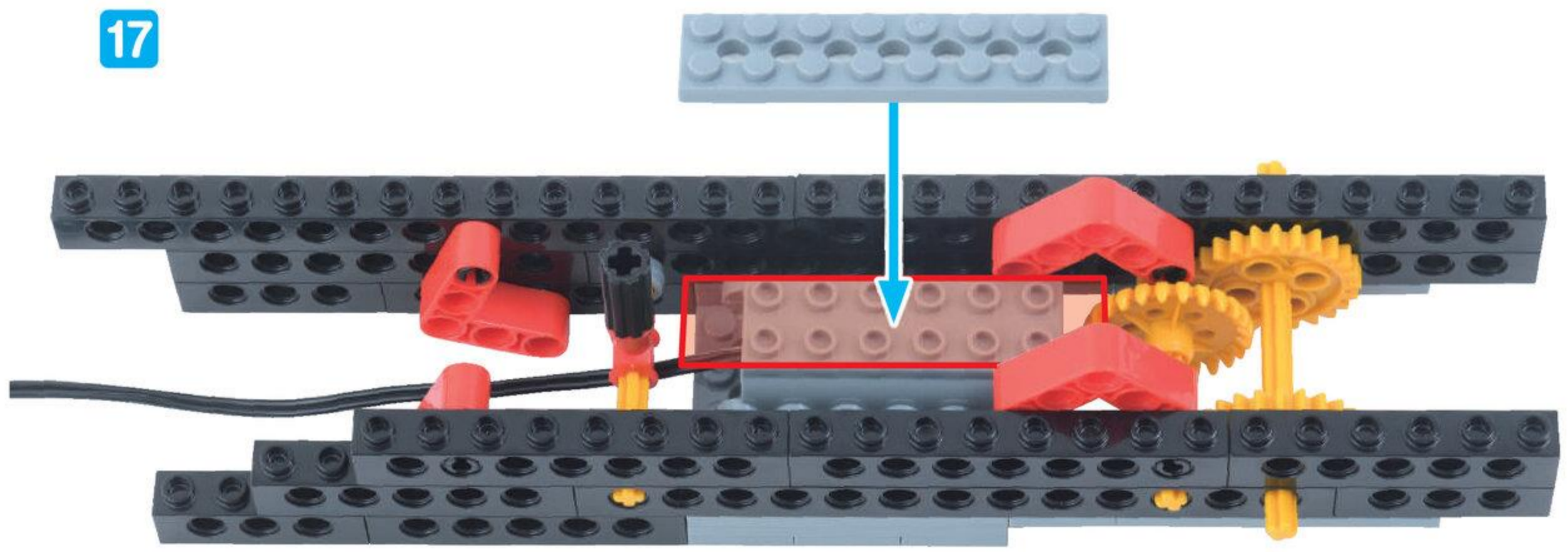

ほち
1 ポチぶん はみでるよ



ほち
1 ポチぶん

ふとぶれえとゆんぼち
太プレート4ポチ 1こ



ぶれえとる
プレートL 1こ

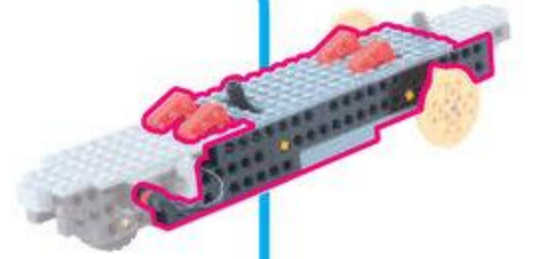
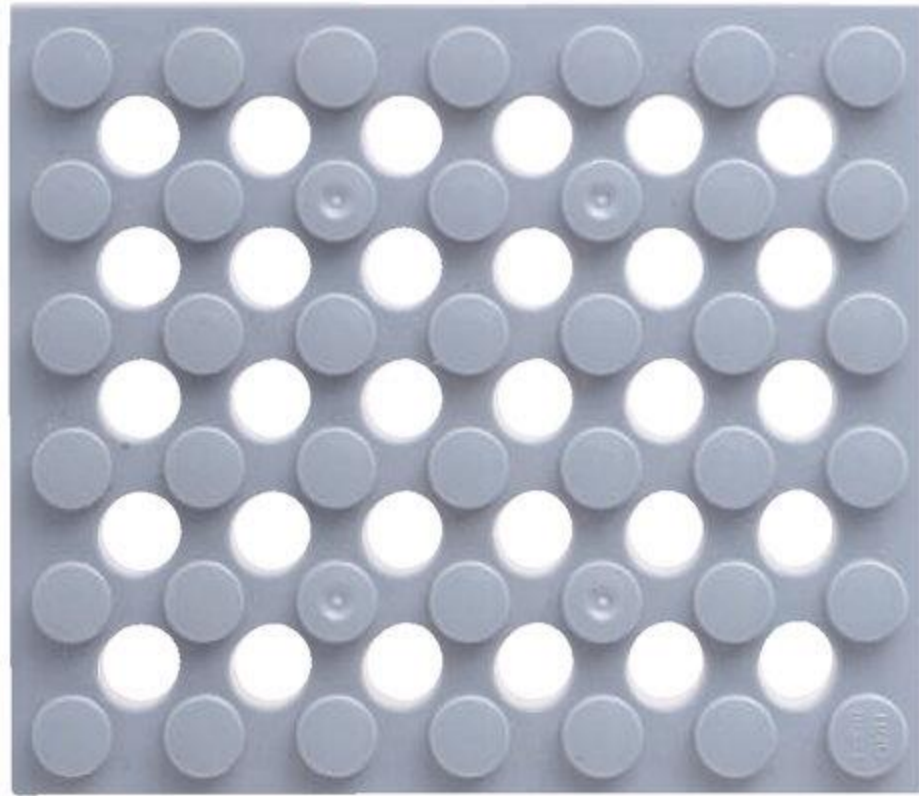

18

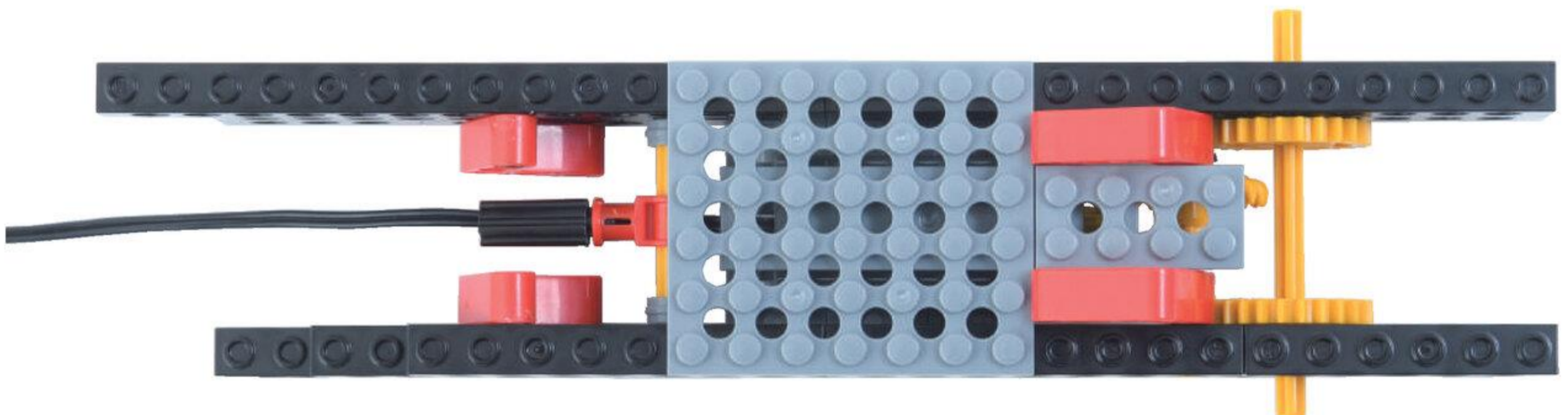
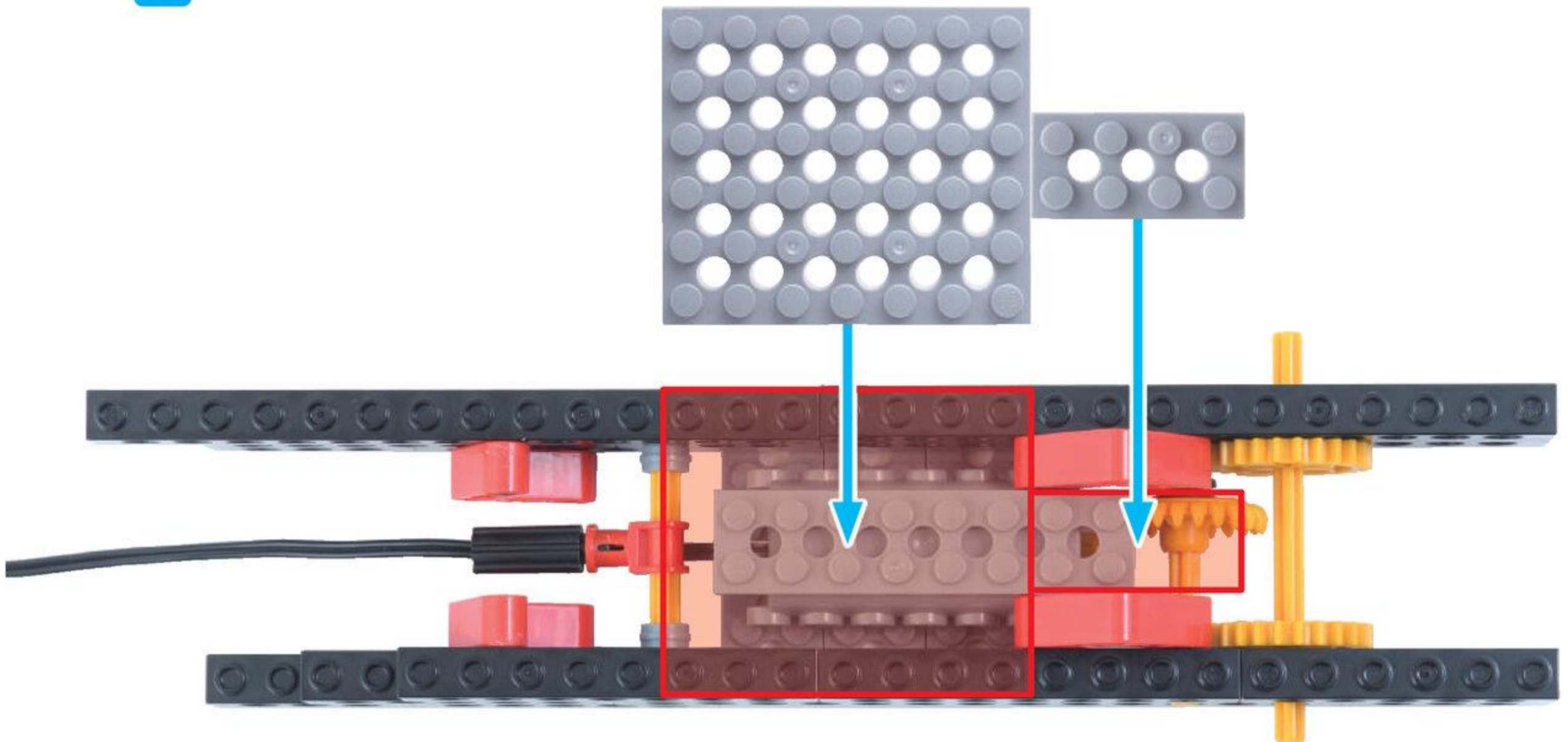

ほそぶれえとろくぼち
細プレート6ポチ 1こ



ほそぶれえとゆんぼち
細プレート4ポチ 2こ



ふとぶれえとろくぼち
太プレート6ポチ 1こ



19

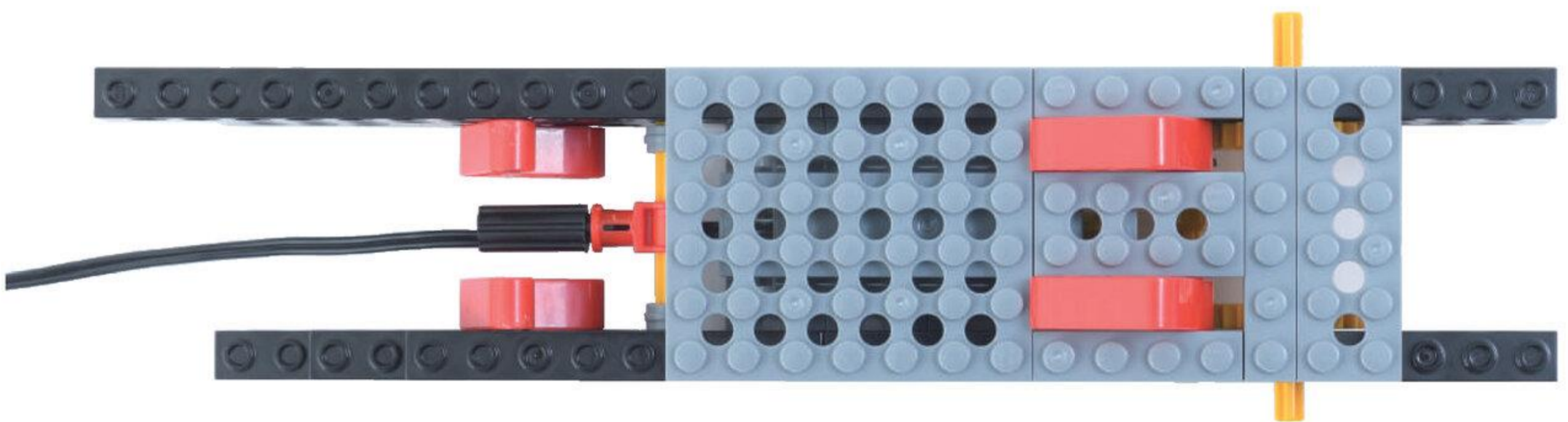
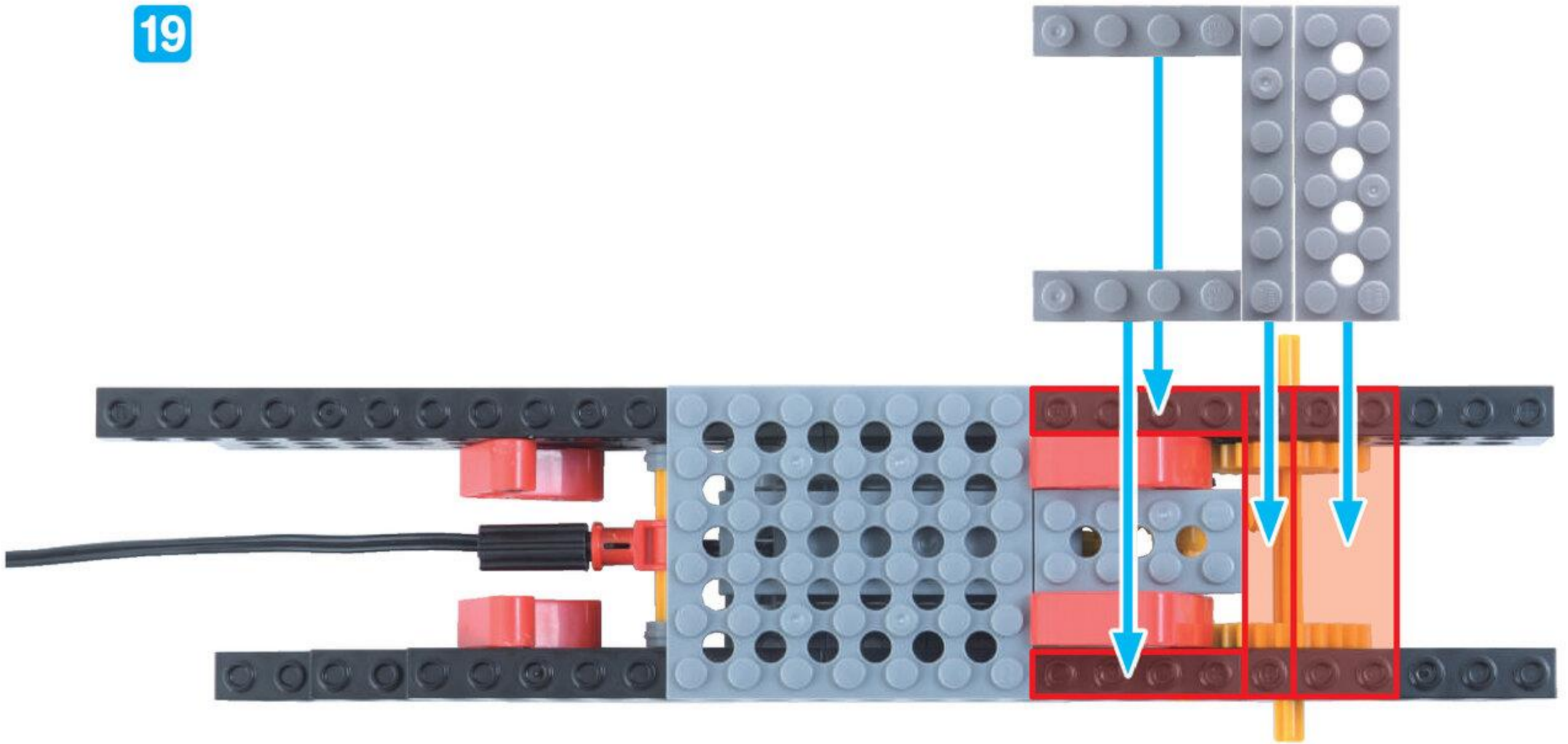

ほそぶれえといち ぼち
細プレート 1 ポチ **2** こ



ほそぶれえとろく ぼち
細プレート 6 ポチ **1** こ



20

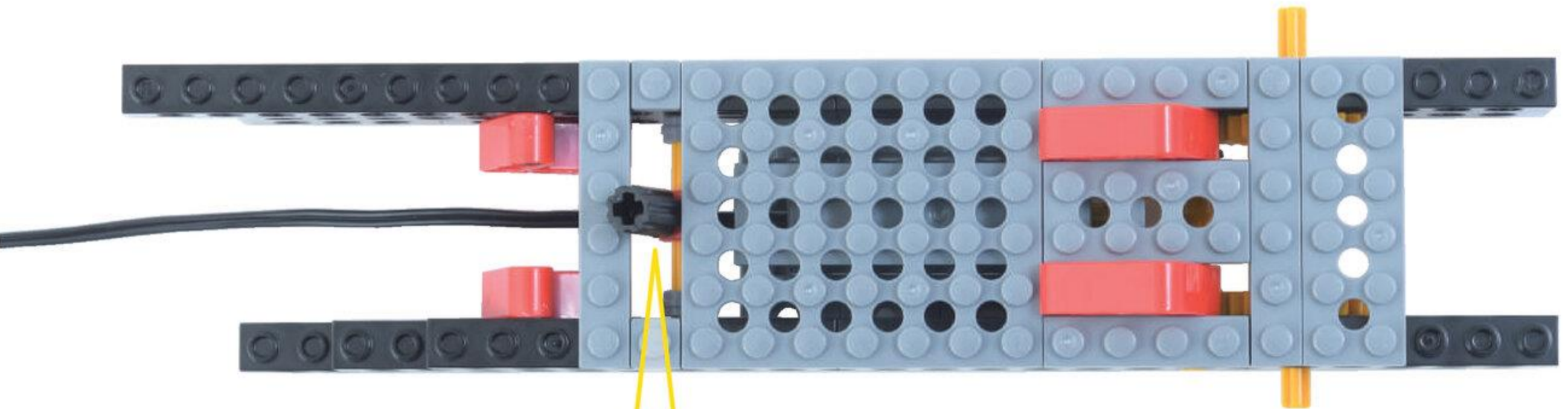
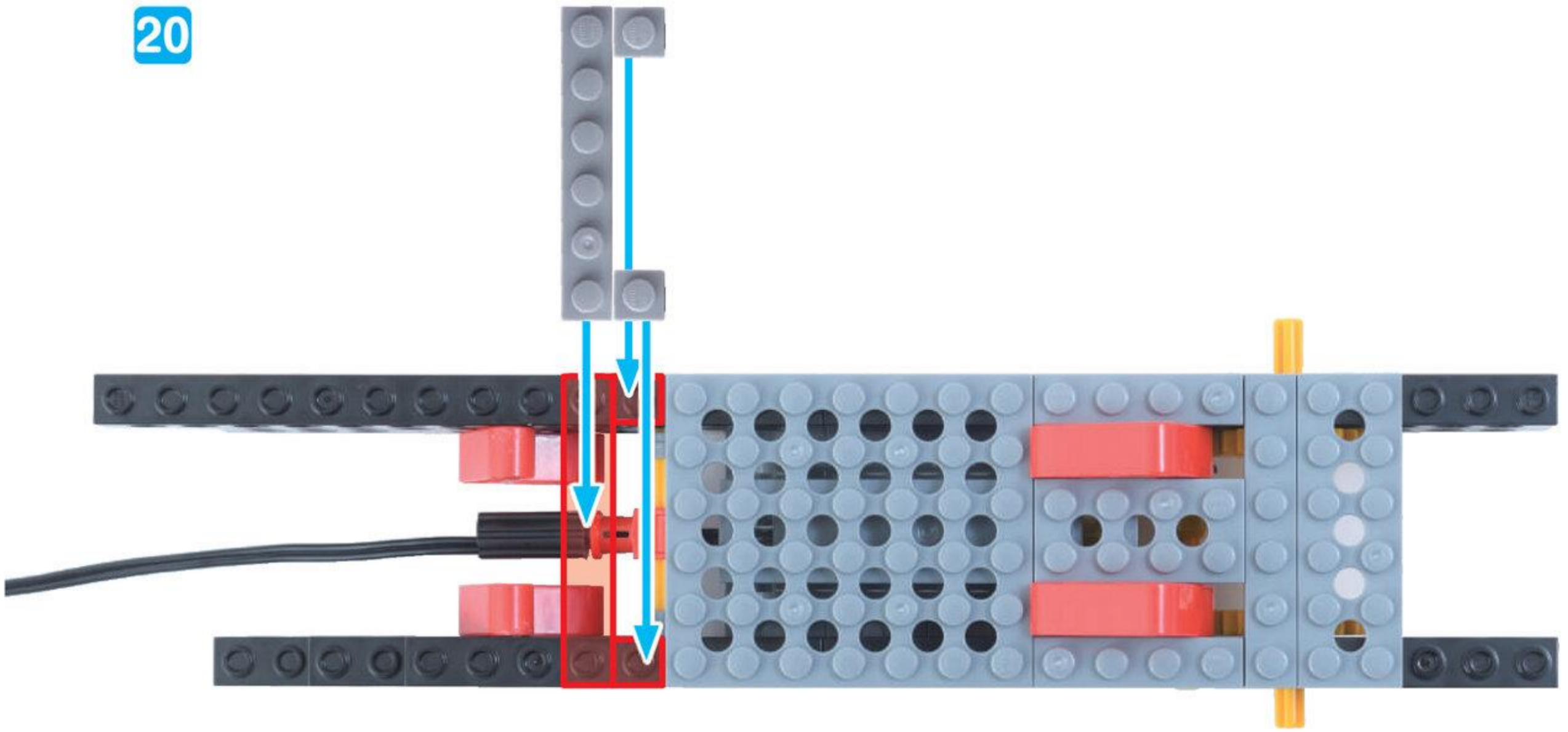

しゃふとじょいんと
シャフトジョイントの むきに ちゅうい



ふれえとろ
プレートL 1こ

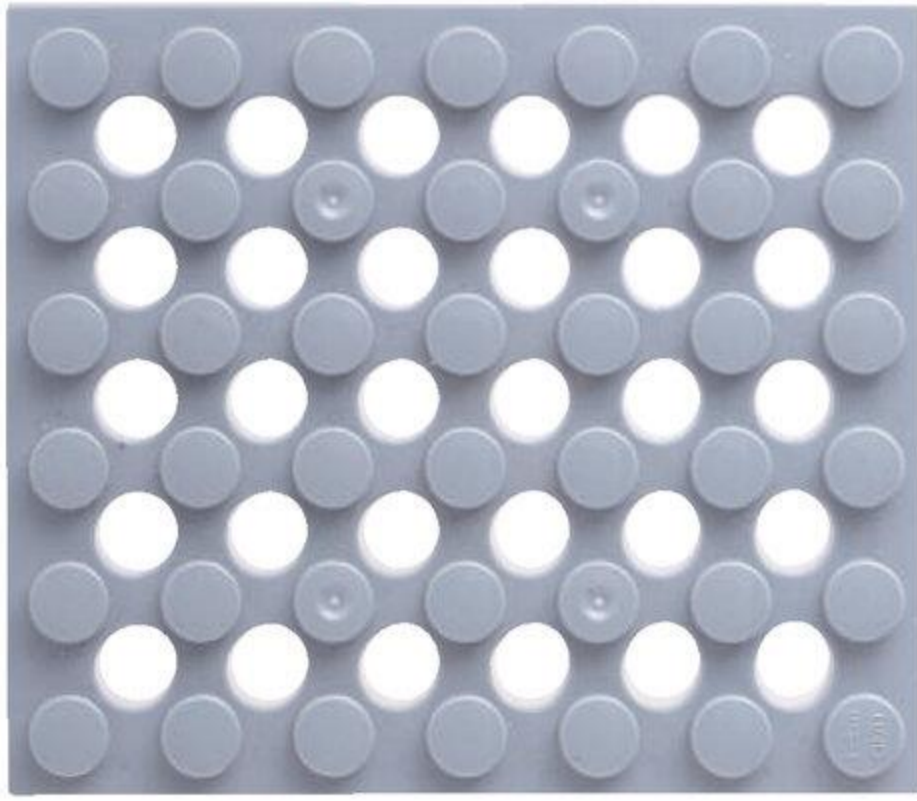

ふとふれえとろくほち
太プレート6ポチ 1こ

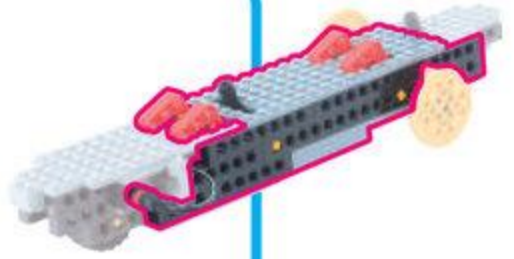

21

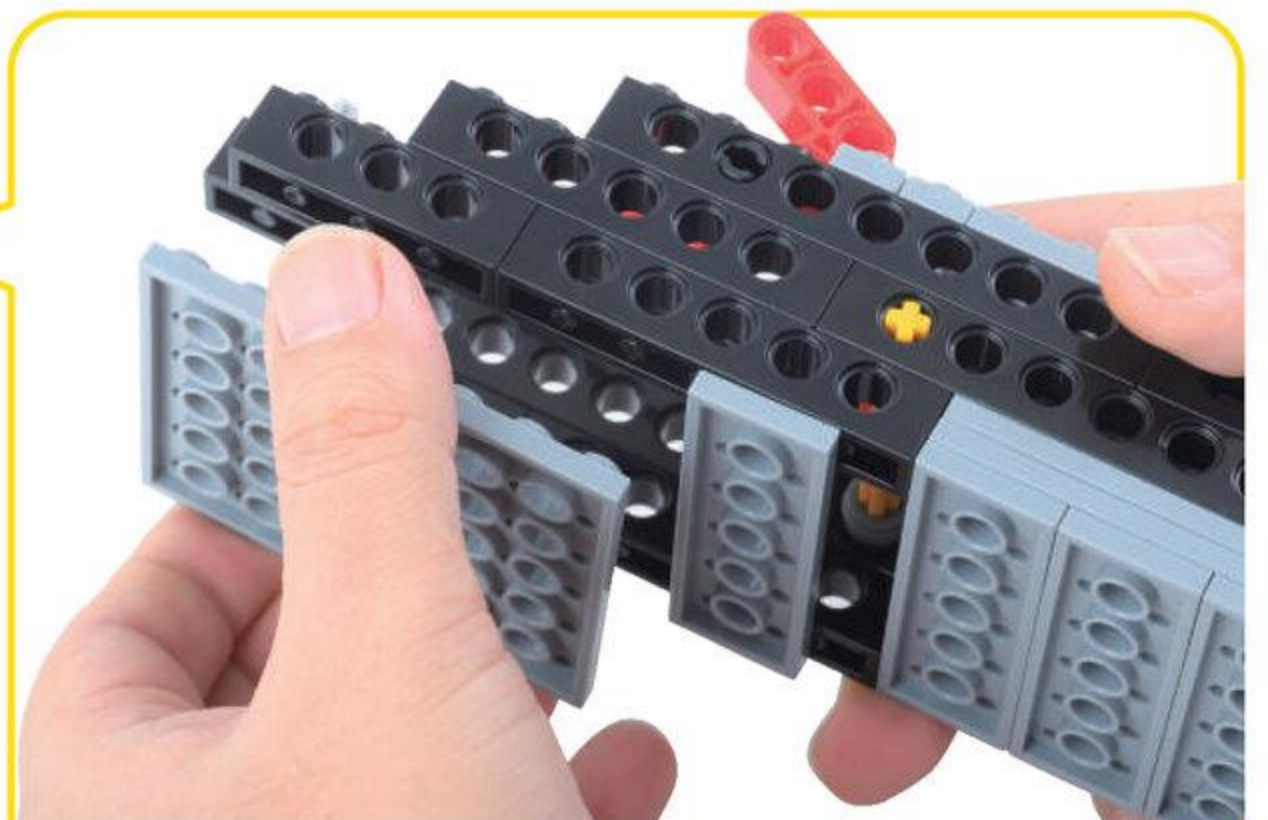
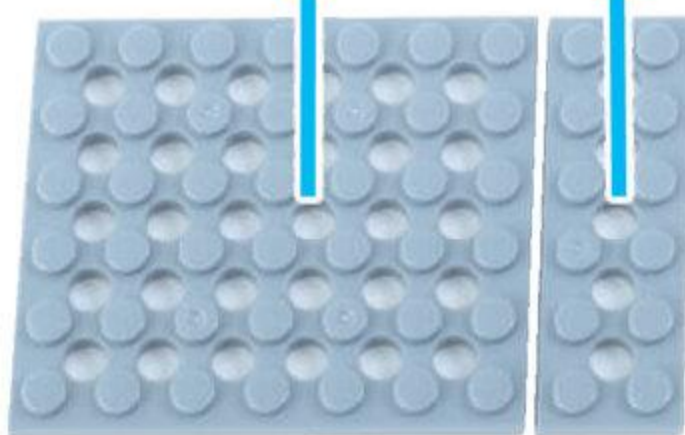
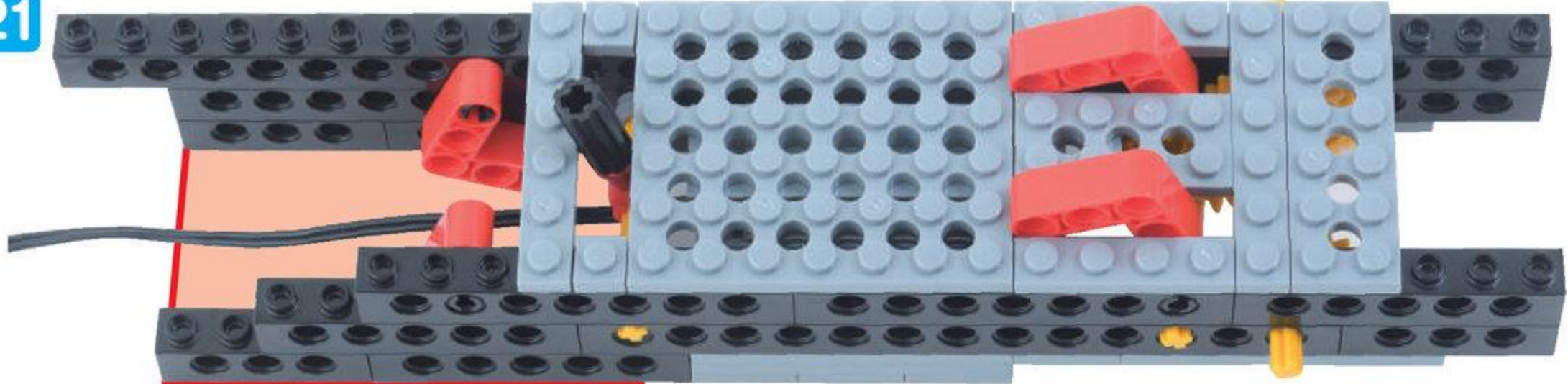

したから とりつけるよ

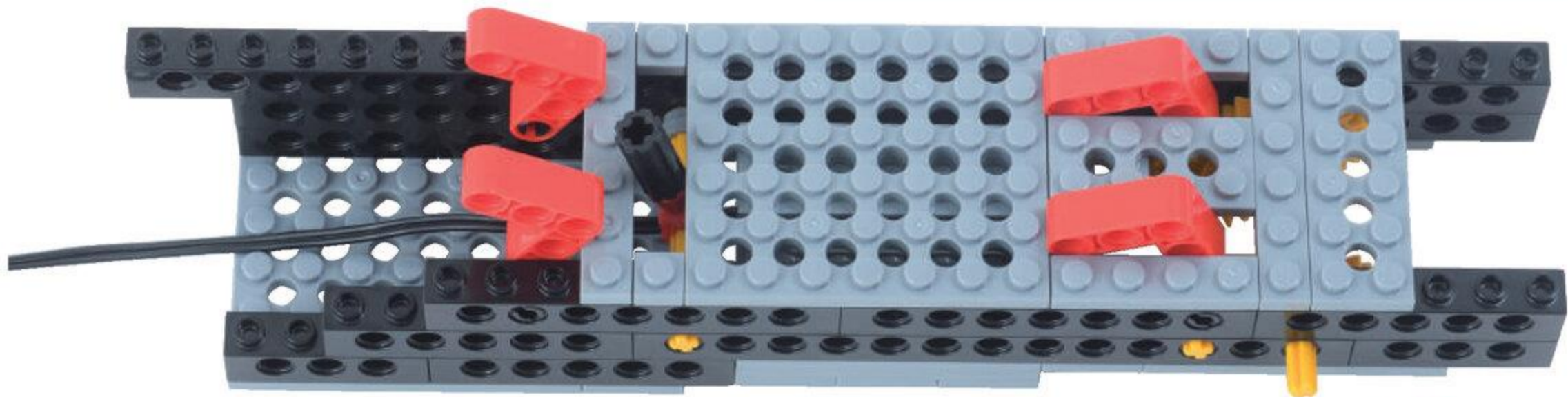

やったね!

ふね (まんなか) が
かんせい

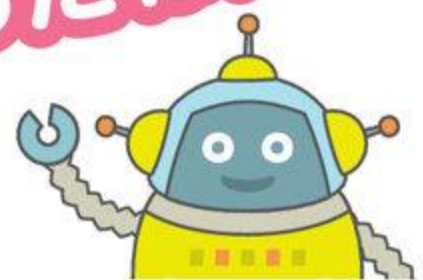

2 ふね (まえ)

めやす 15 ぶん

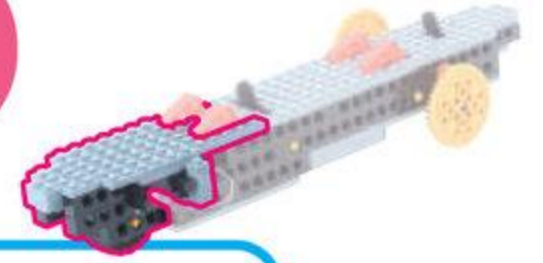

びいむよんぼち
ビーム 4 ポチ 2 こ



びいむろくぼち
ビーム 6 ポチ 1 こ



1

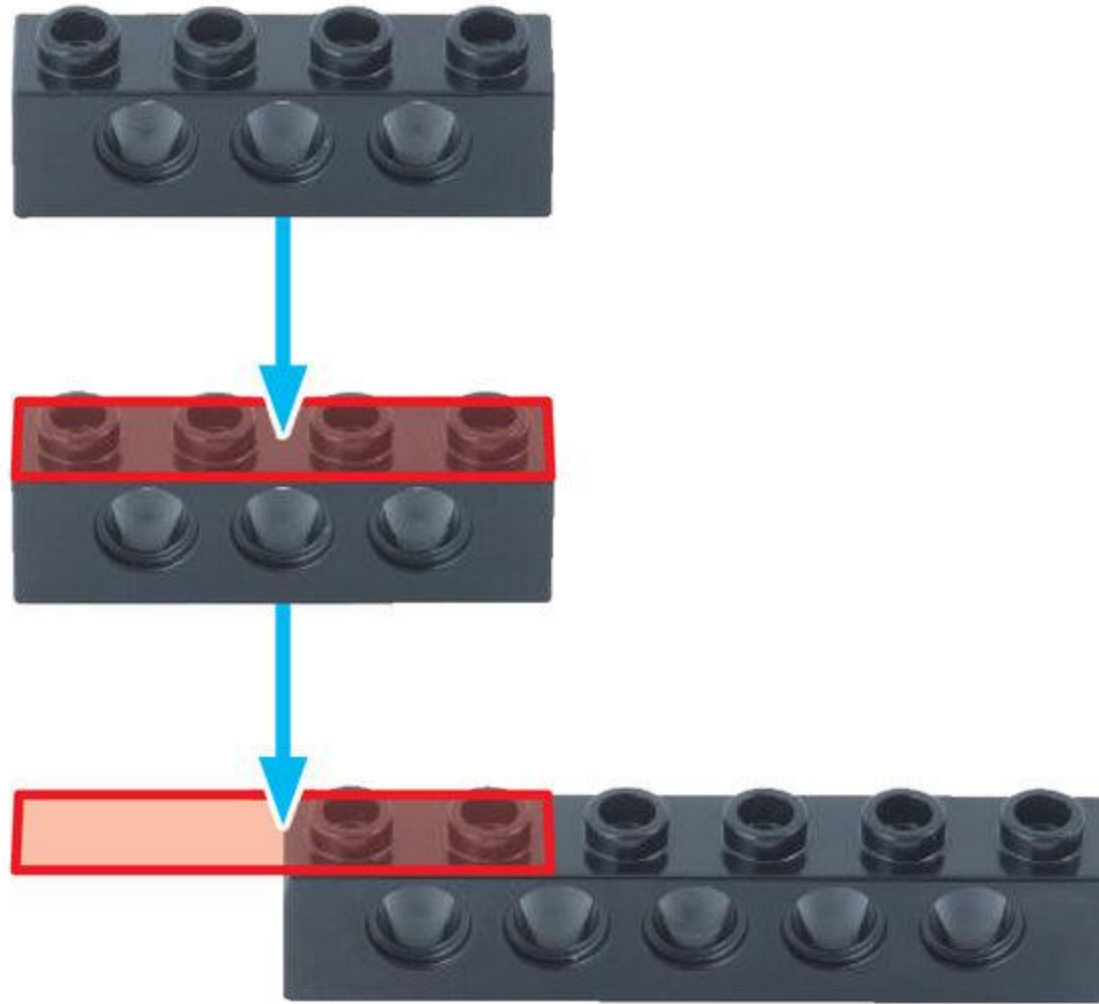

ほそぶれえとにほち
細プレート 2 ポチ **2**こ



ほそぶれえとよんほち
細プレート 4 ポチ **1**こ

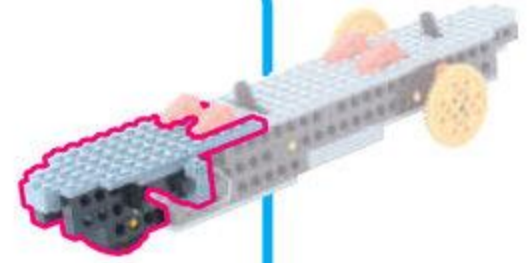

2

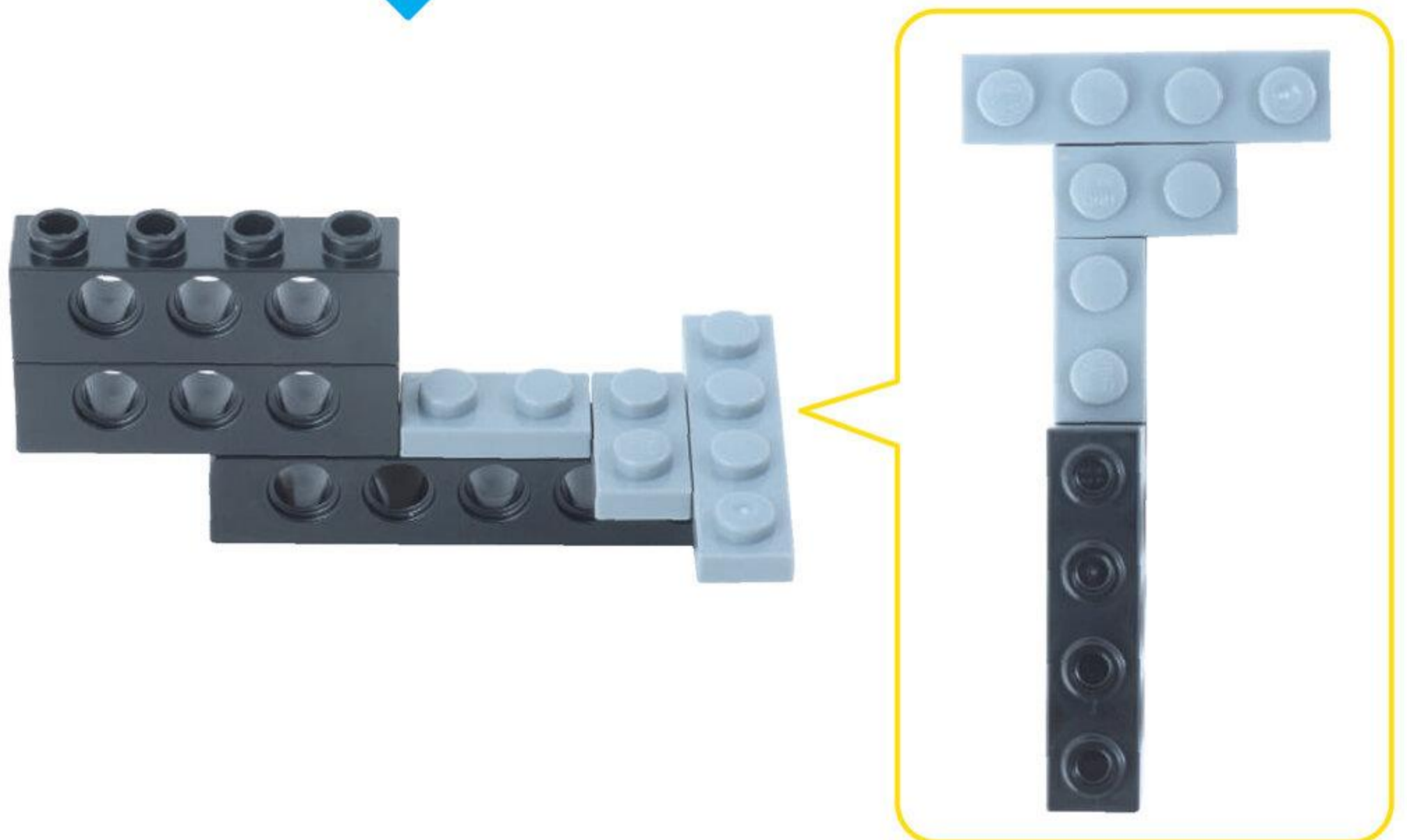
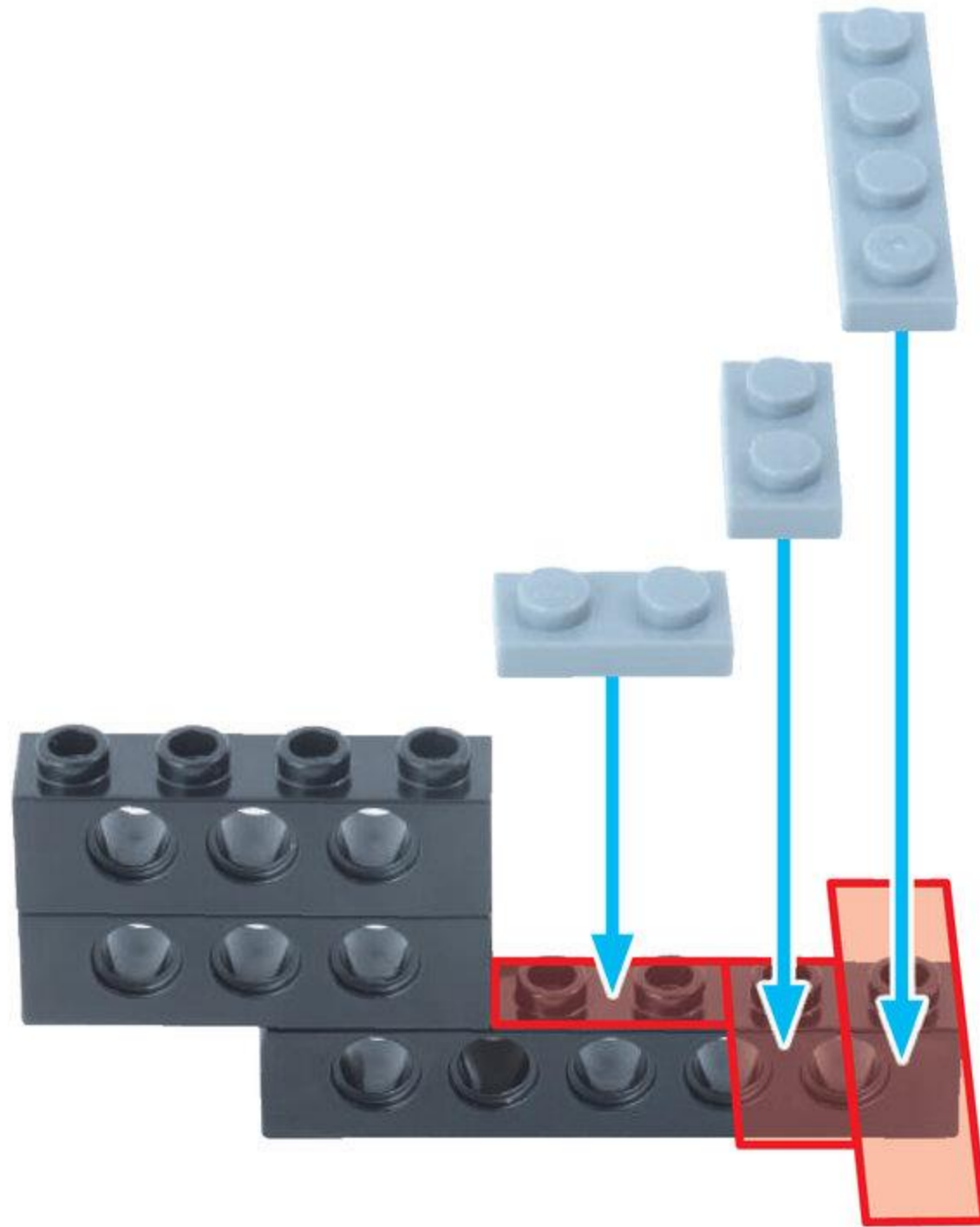

ばってりいぼっくす すらいどすいっち 1こ
バッテリーボックス / スライドスイッチ 1こ

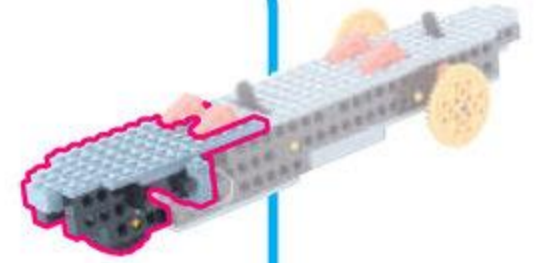

3

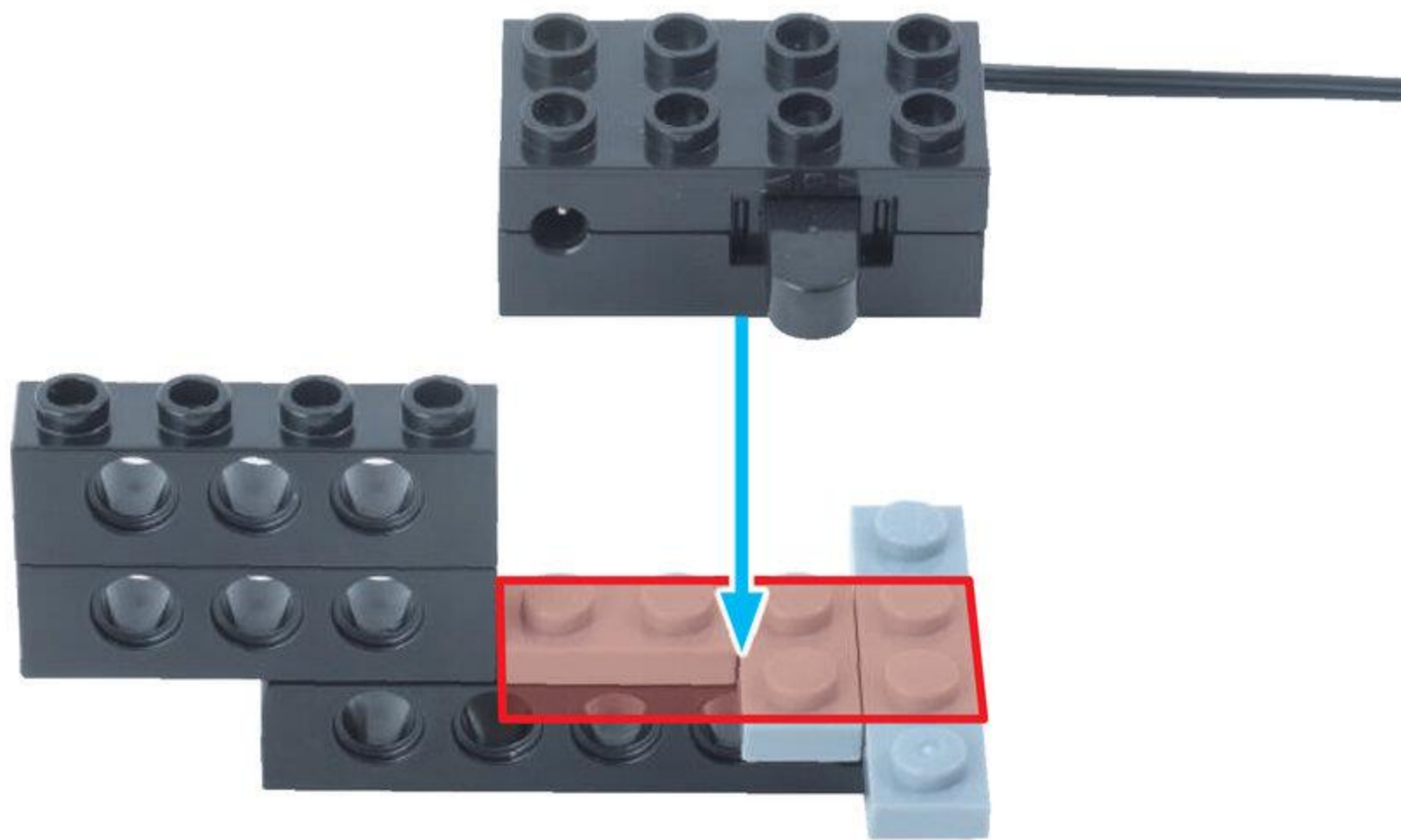

ほそぶれえといちぼち
細プレート 1 ポチ 1こ



びいむいちぼち
ビーム 1 ポチ 1こ

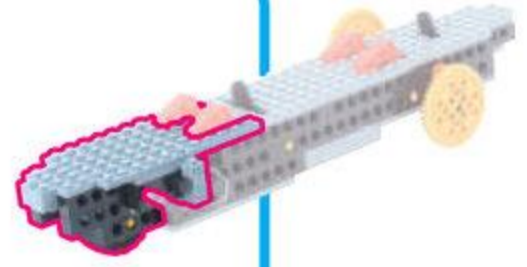

4

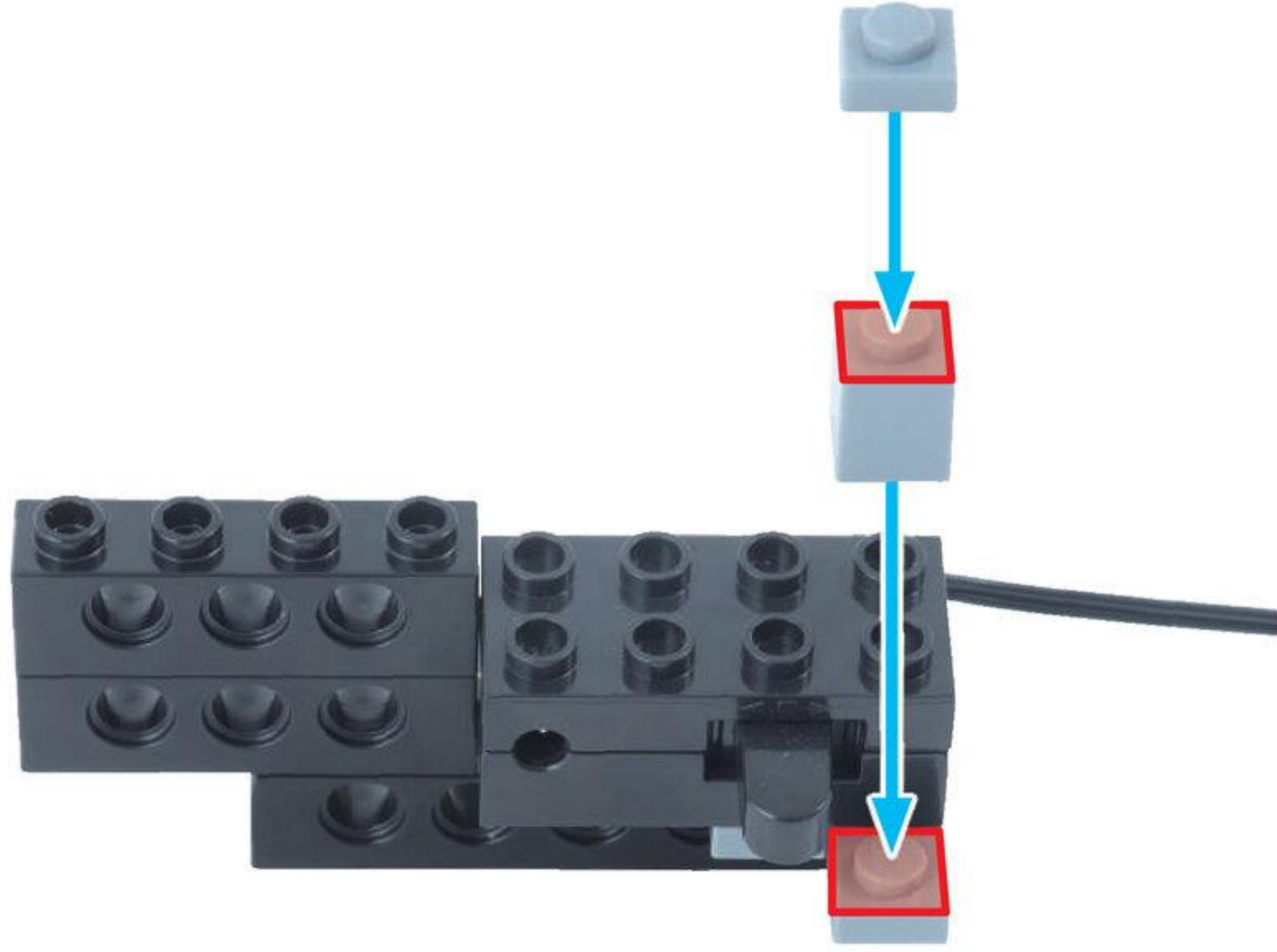

ほそぶれえとにほち
細プレート2ポチ 4こ

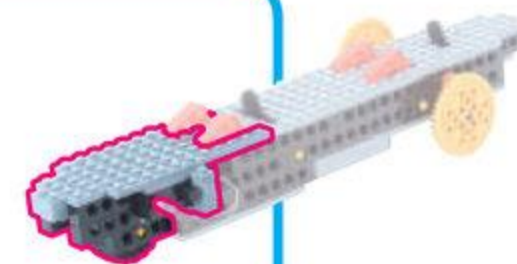

5

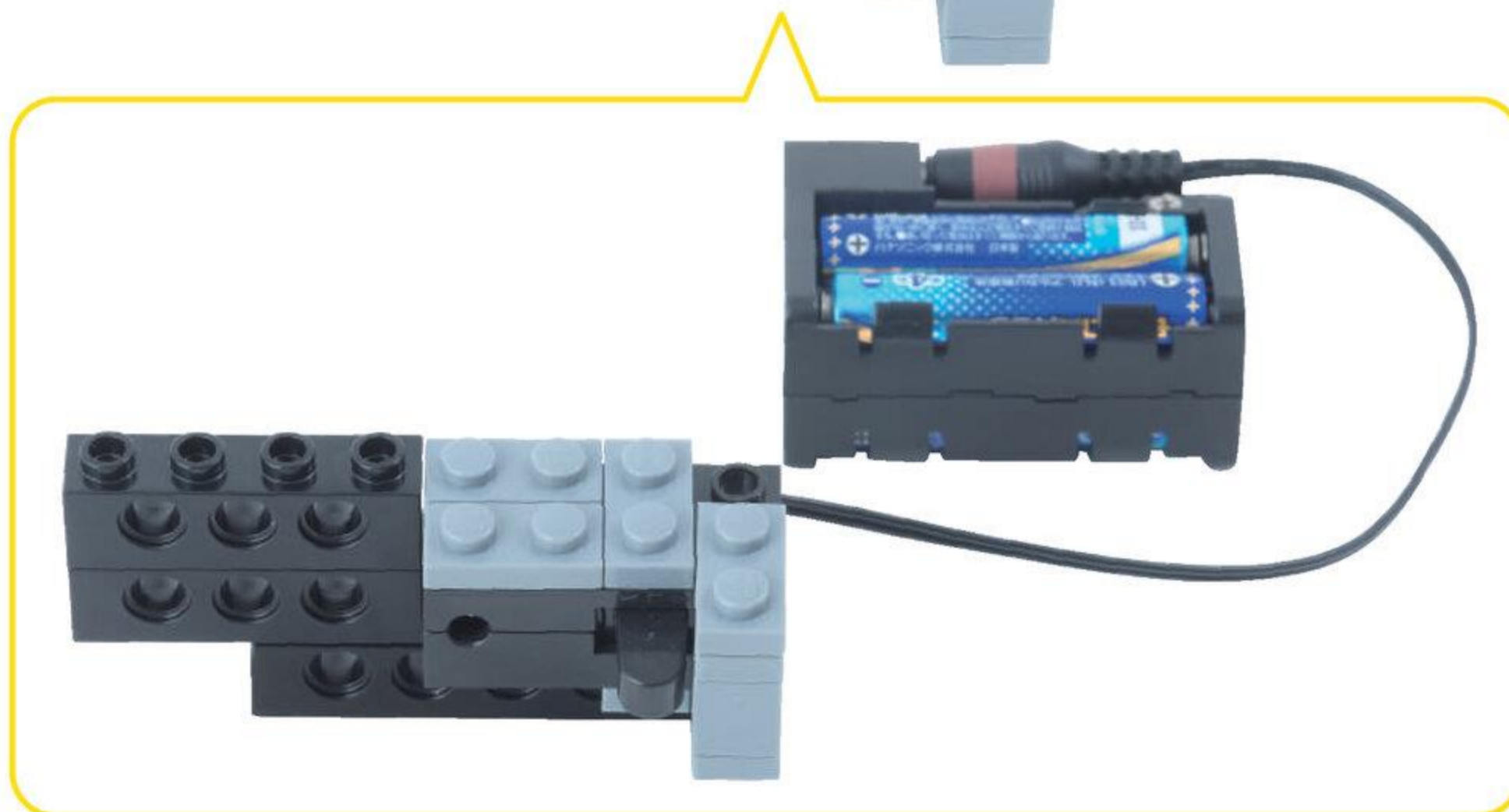
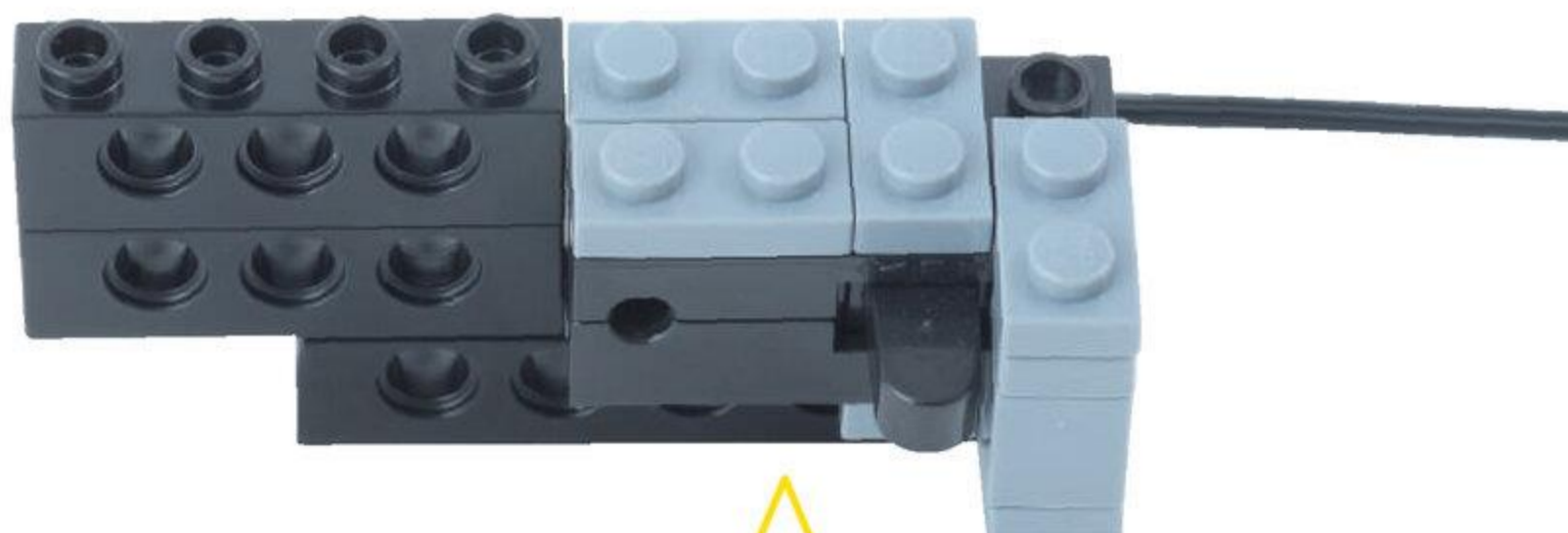
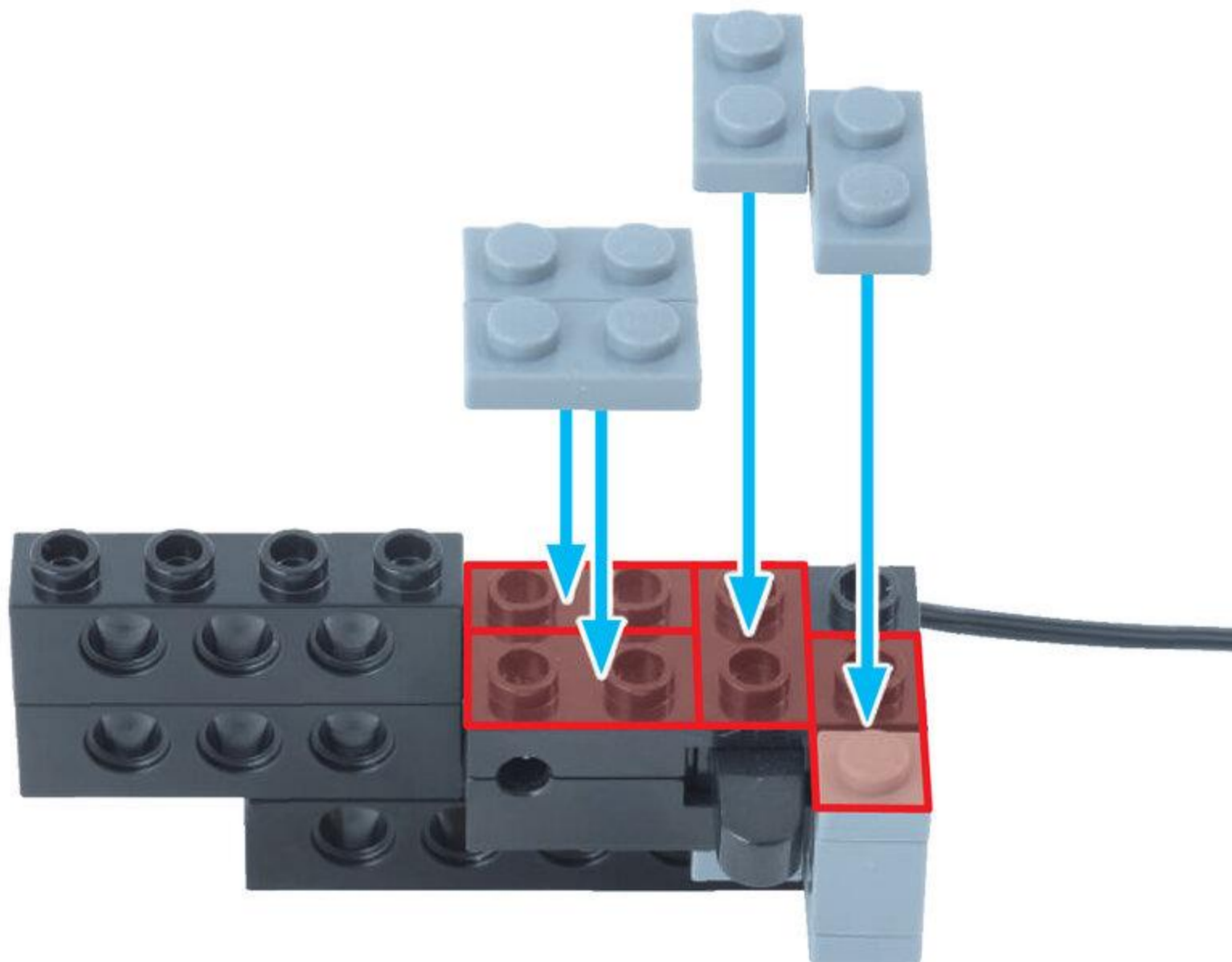

びいむはちほち
ビーム 8 ポチ **2**こ

びいむろくほち
ビーム 6 ポチ **1**こ



6

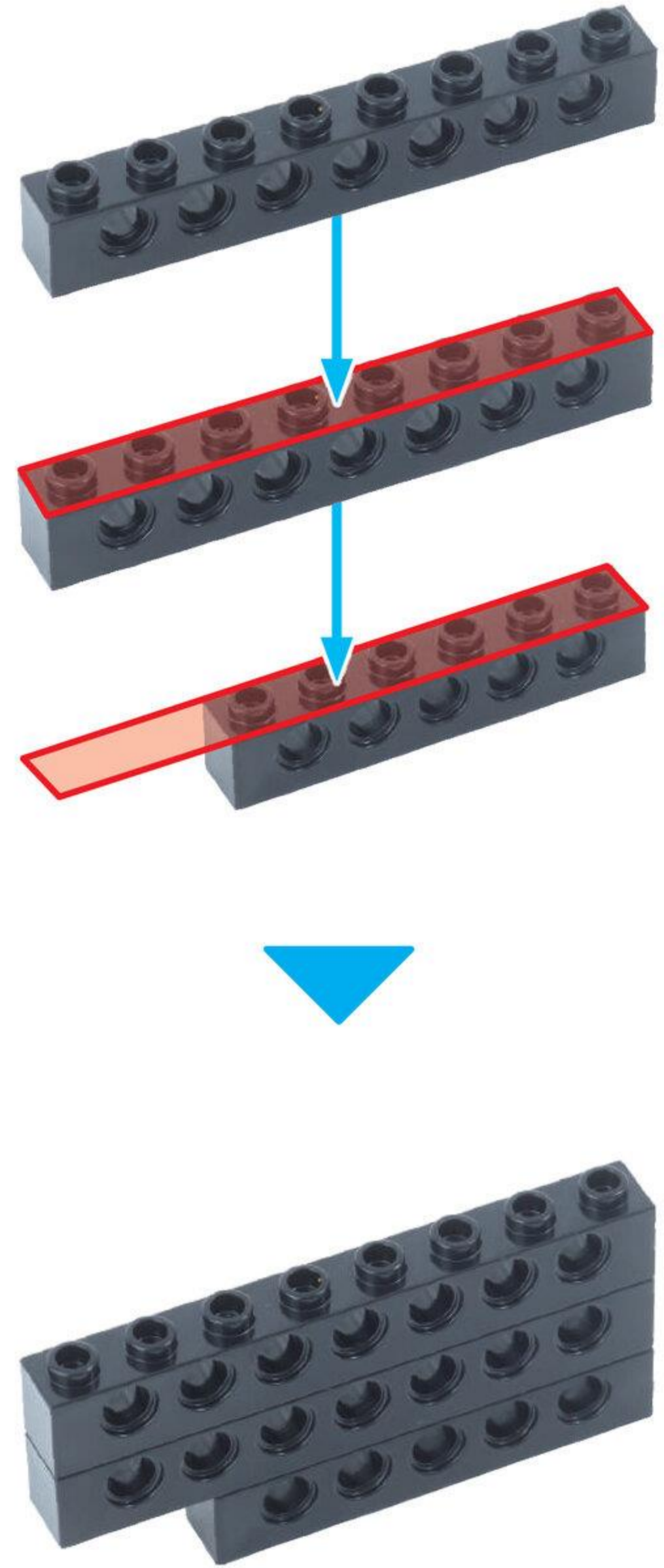

タイヤ S 1こ



シャフト 4ポチ 1こ



ながさに
ちゅうい

ぶっしゅ 1こ



ピニオンギアうす 1こ

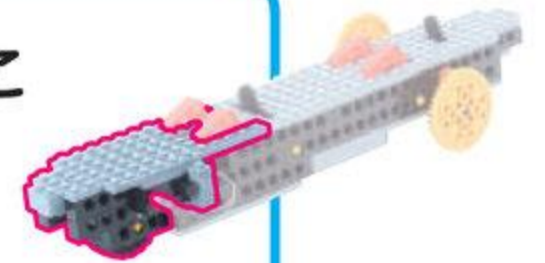
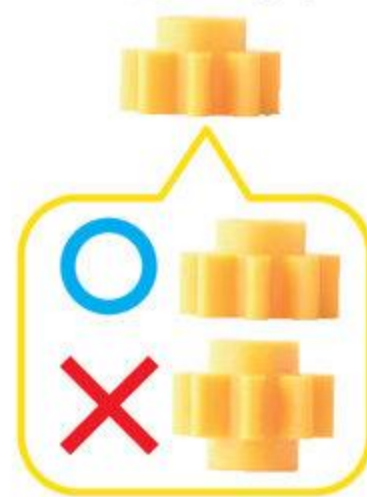

7

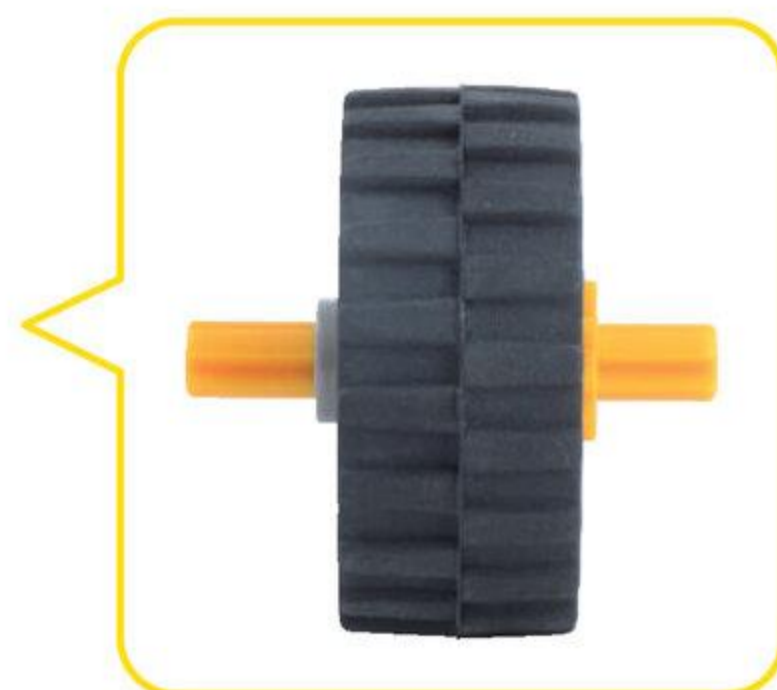
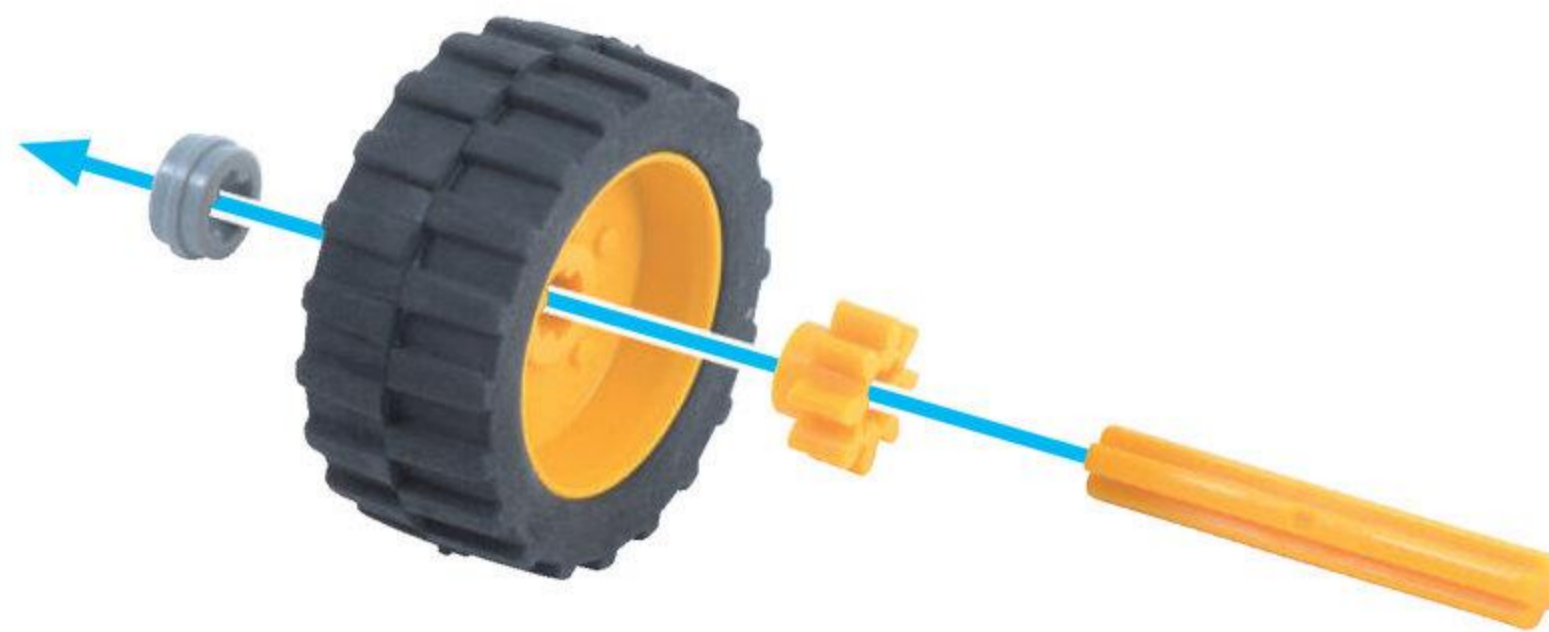

ふとぶれえとよんほち
太プレート 4 ポチ **3**こ



ほそぶれえとにほち
細プレート 2 ポチ **1**こ

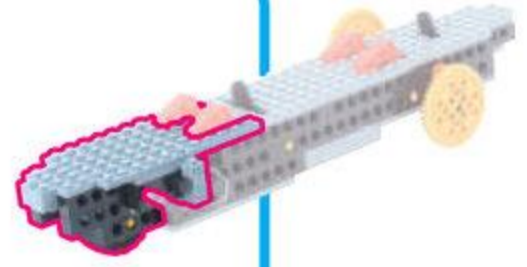

8

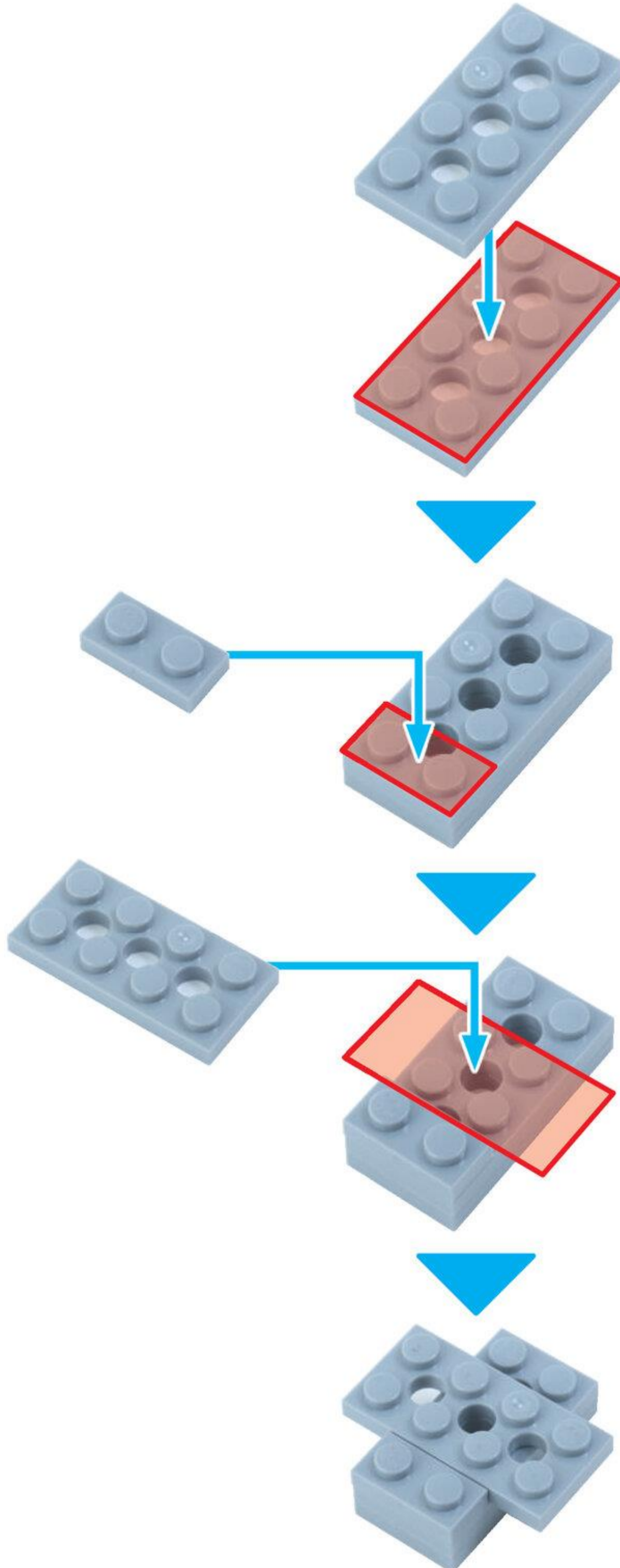

9

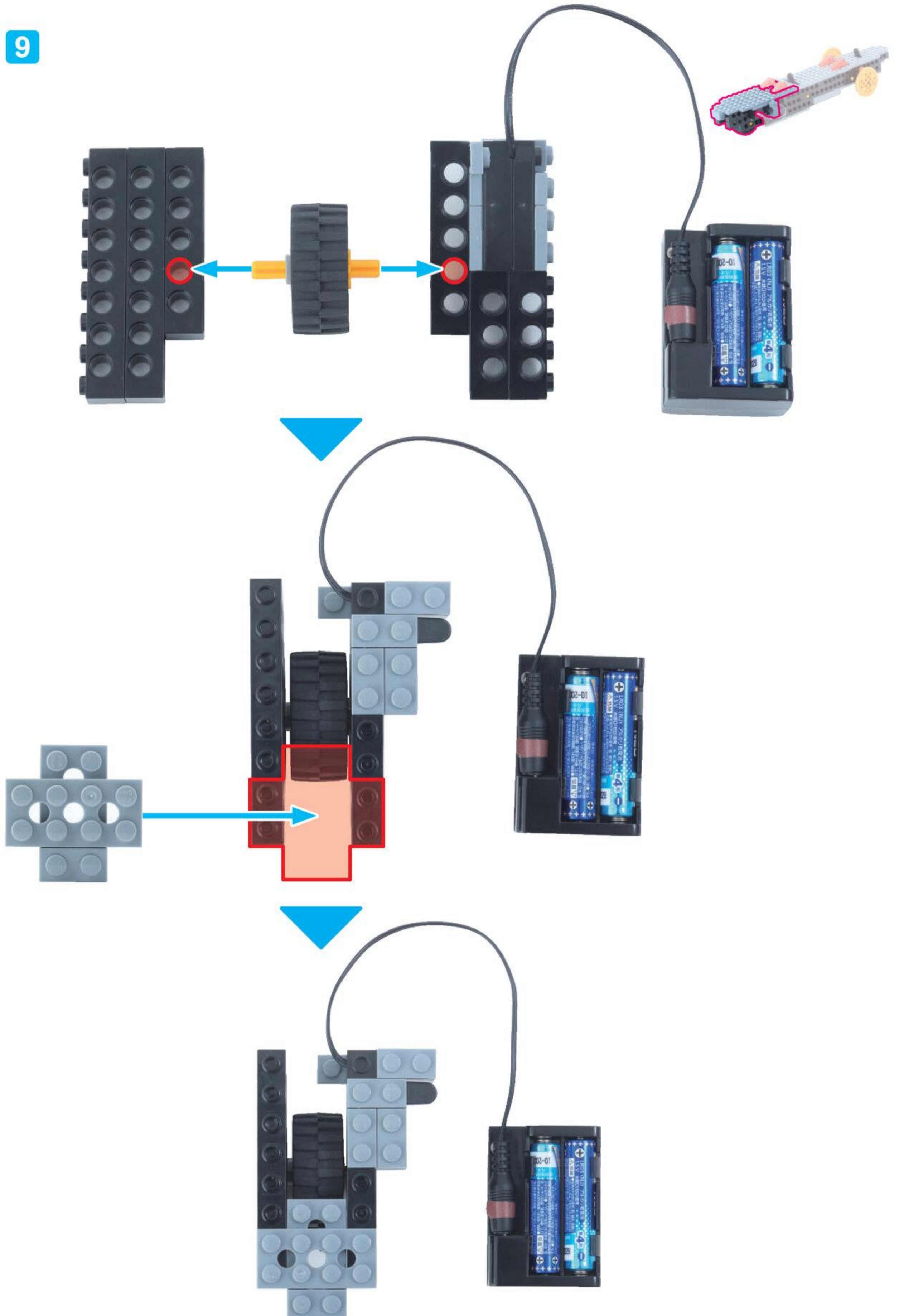

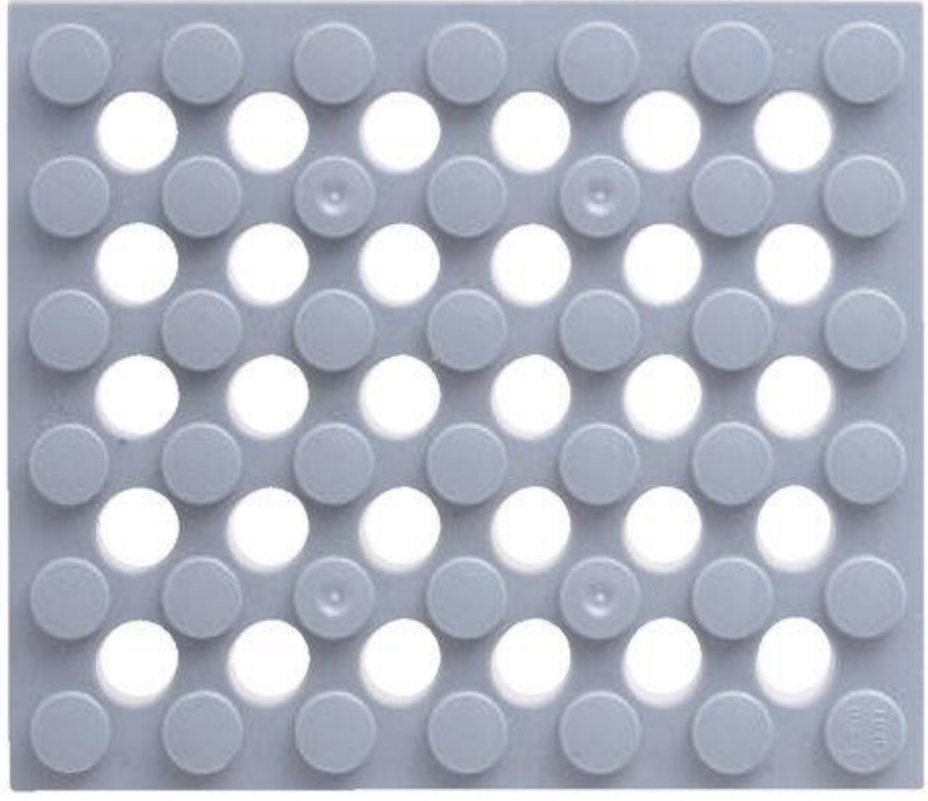

ふれえとろ
プレートL 1こ



ふとふれえとゆんほち
太プレート4ポチ 1こ



ふとふれえとほほち
太プレート8ポチ 1こ



10

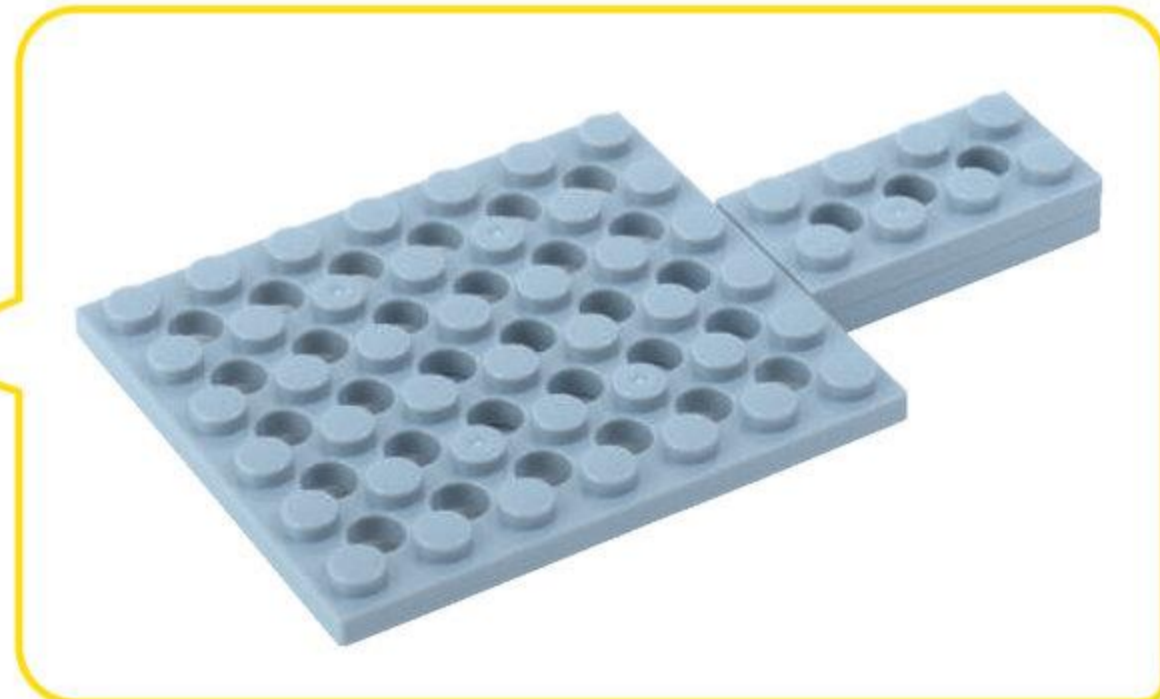
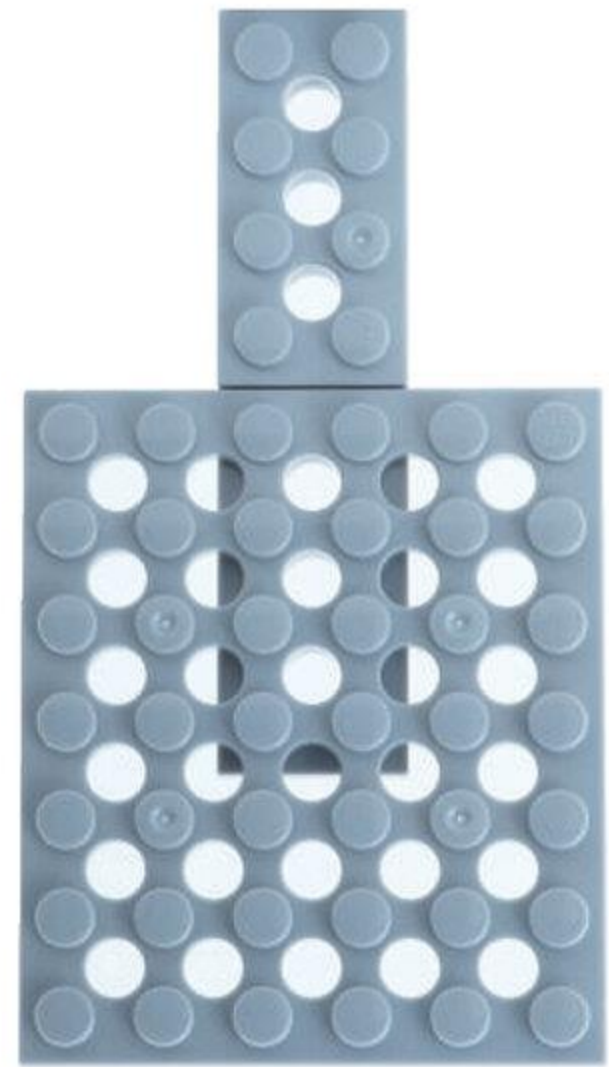
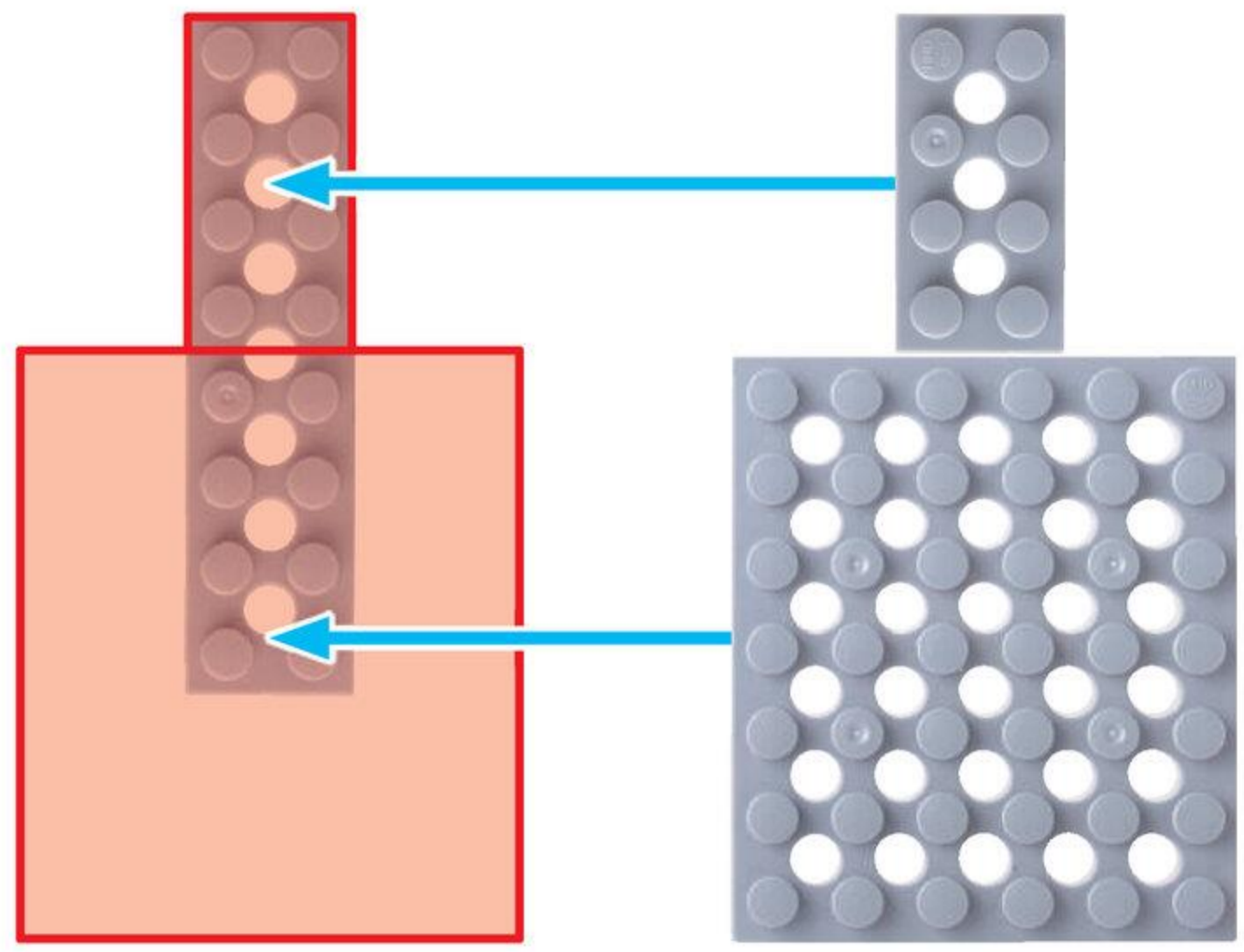

11

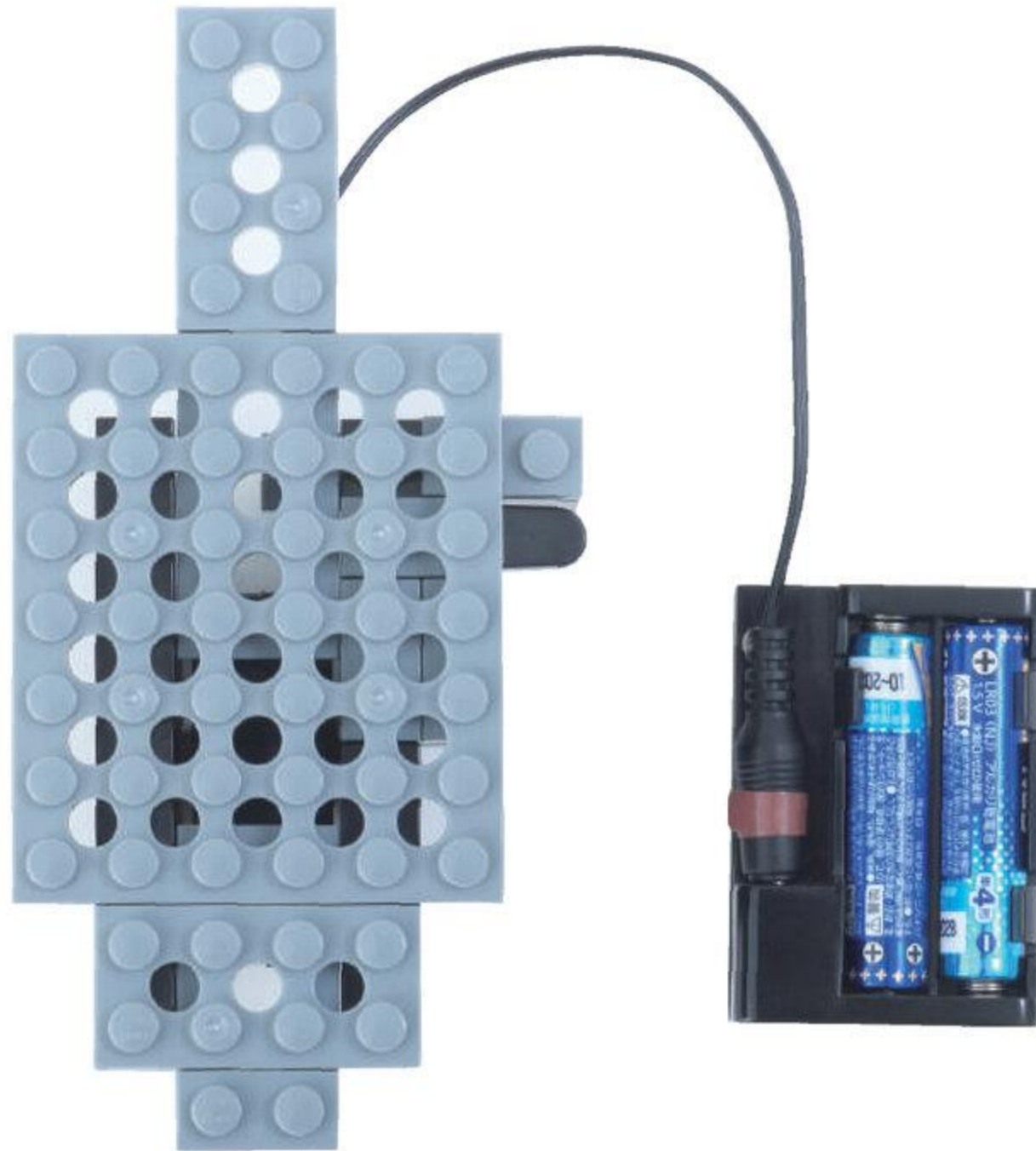
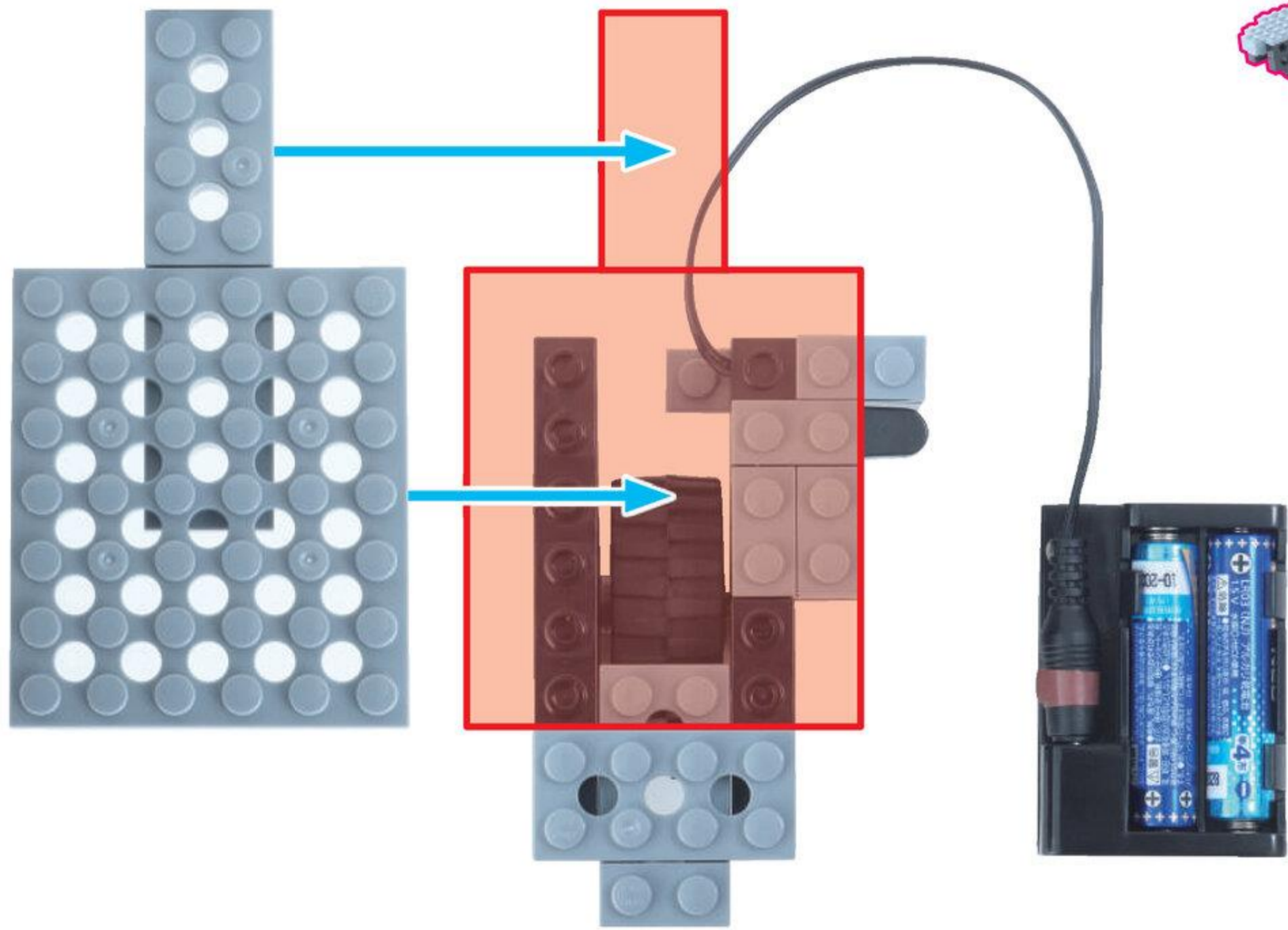

12

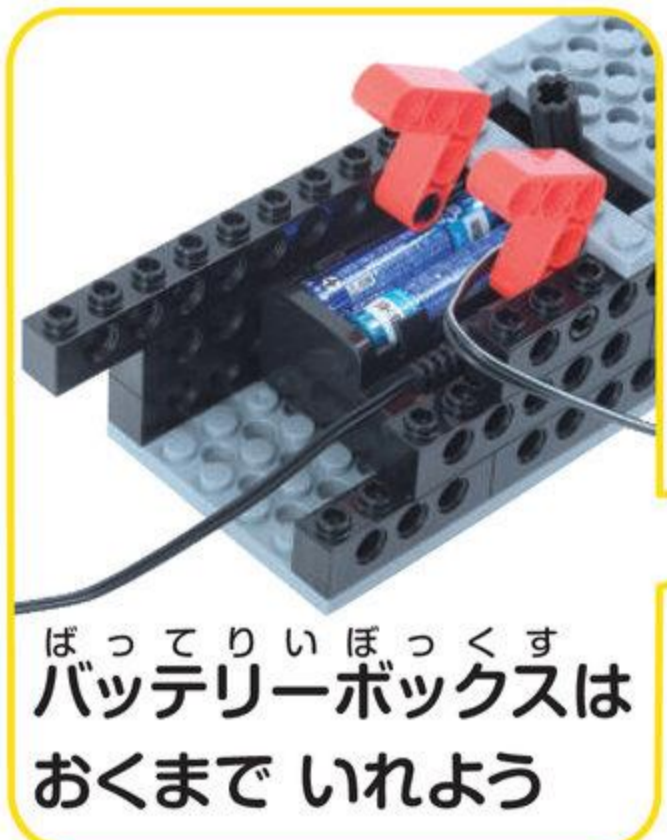
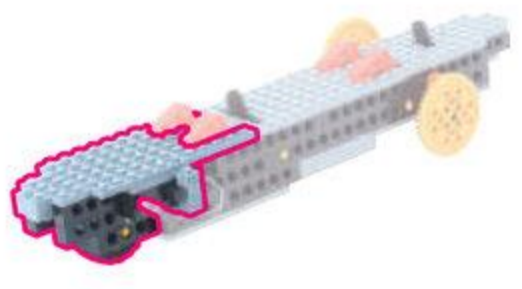

ばってりいほっくす
バッテリーボックスは
おくまで いれよう

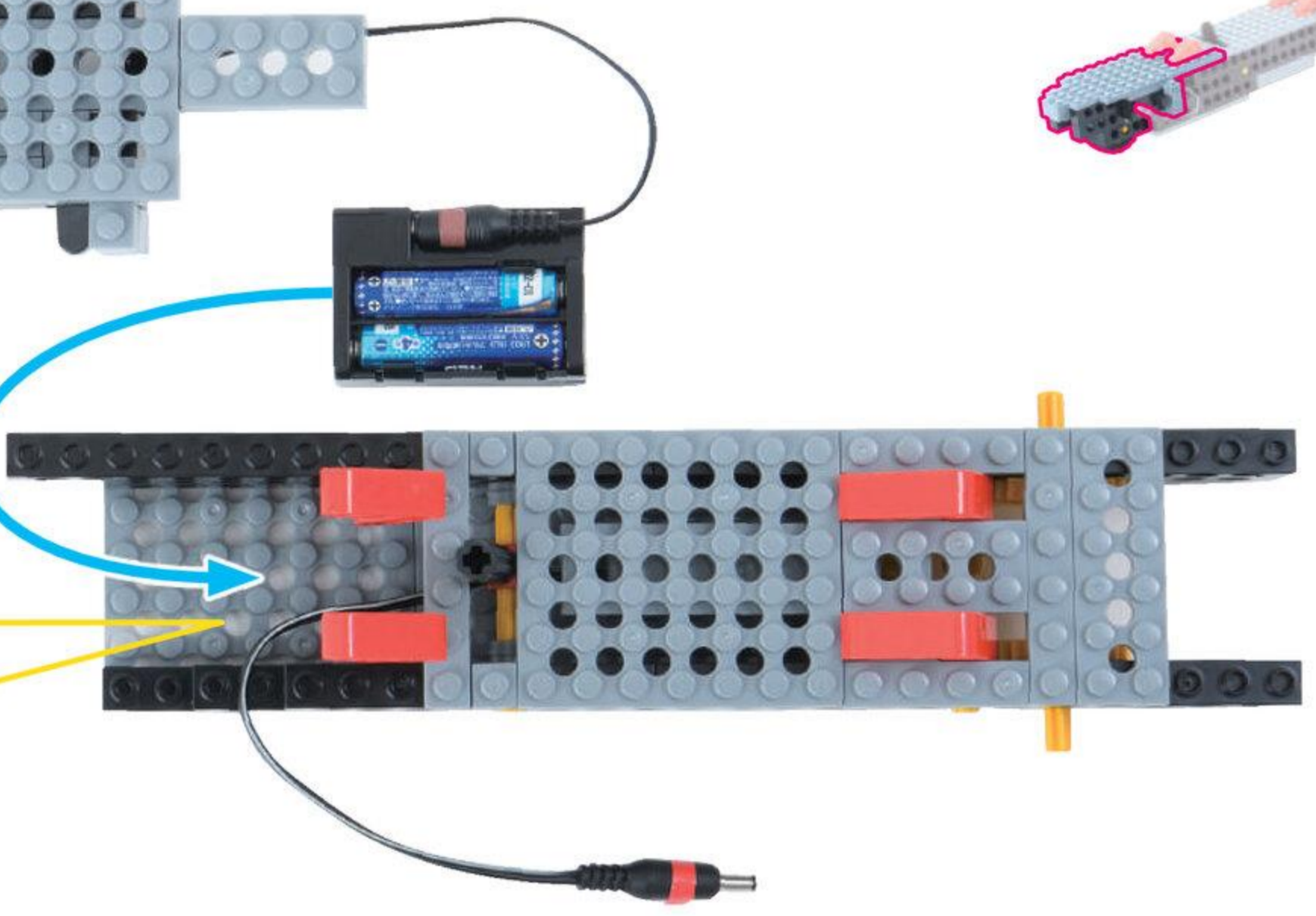

こおと
コードはきれいにたたもう

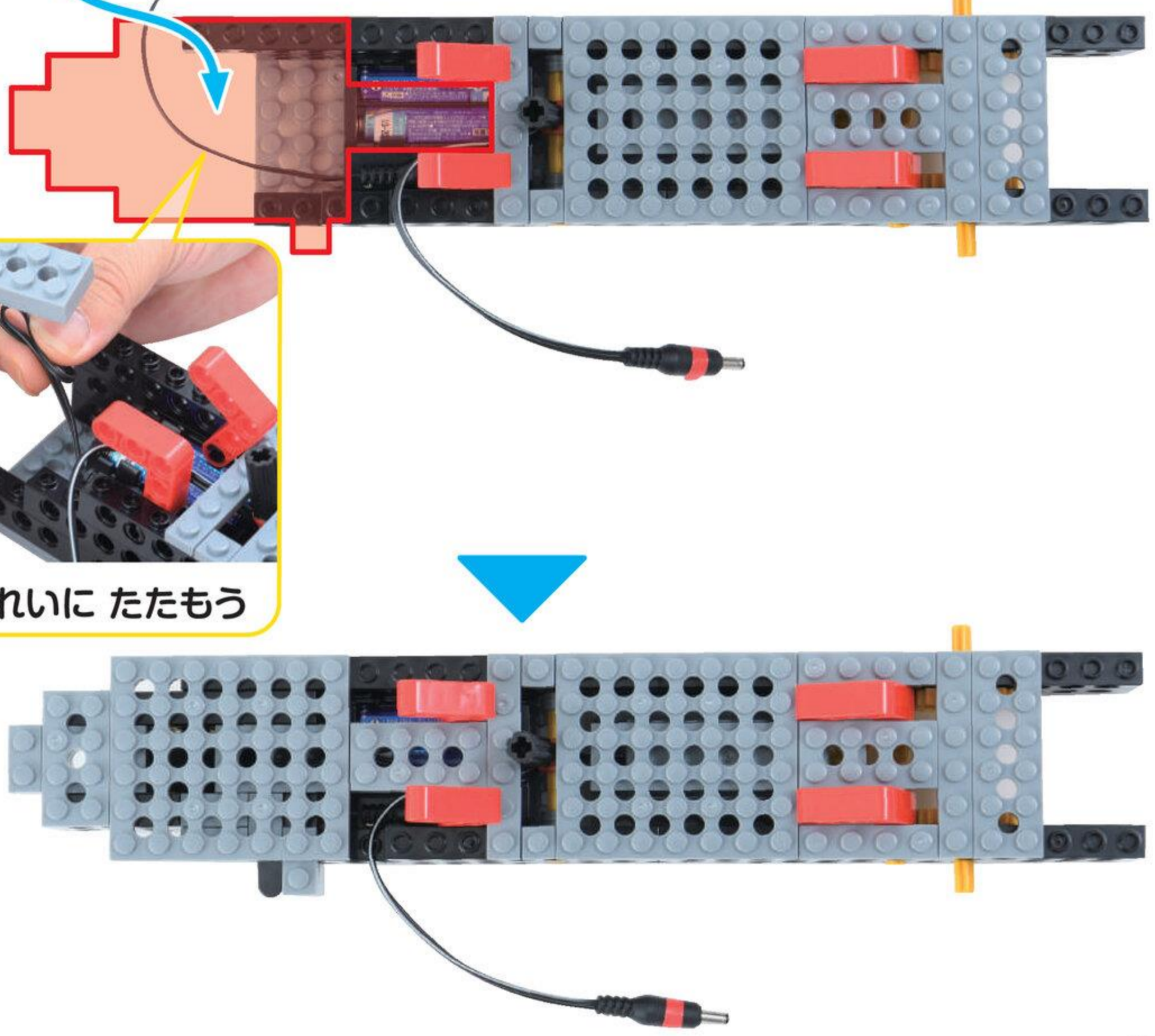

ほそぶれえとよんぼち
細プレート4ポチ 2こ

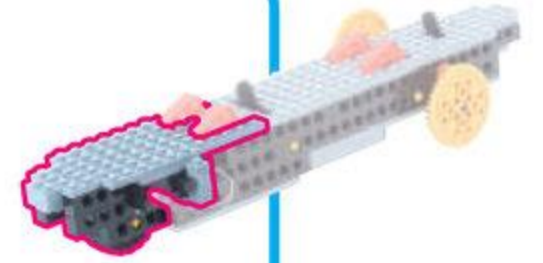

13

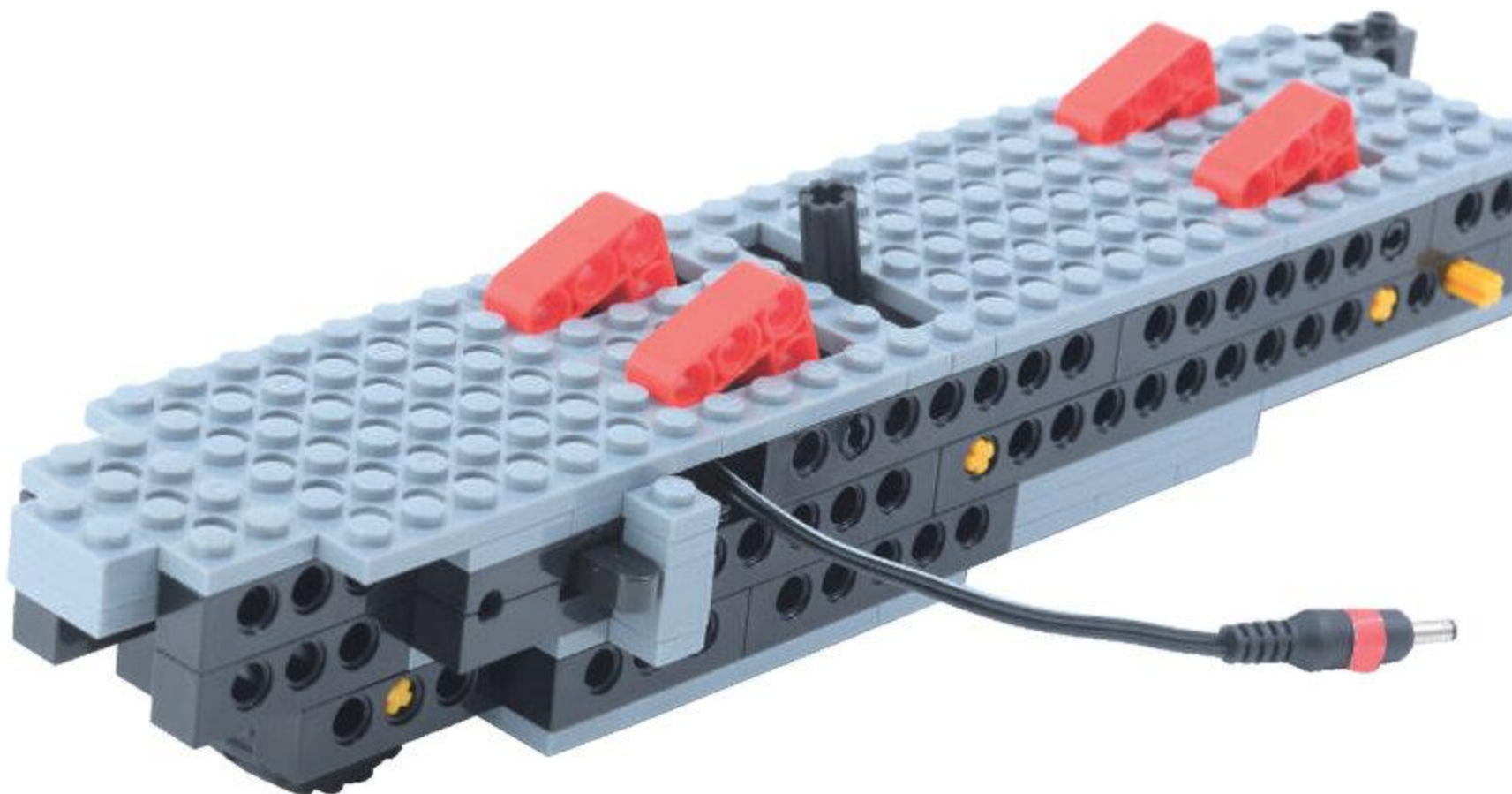
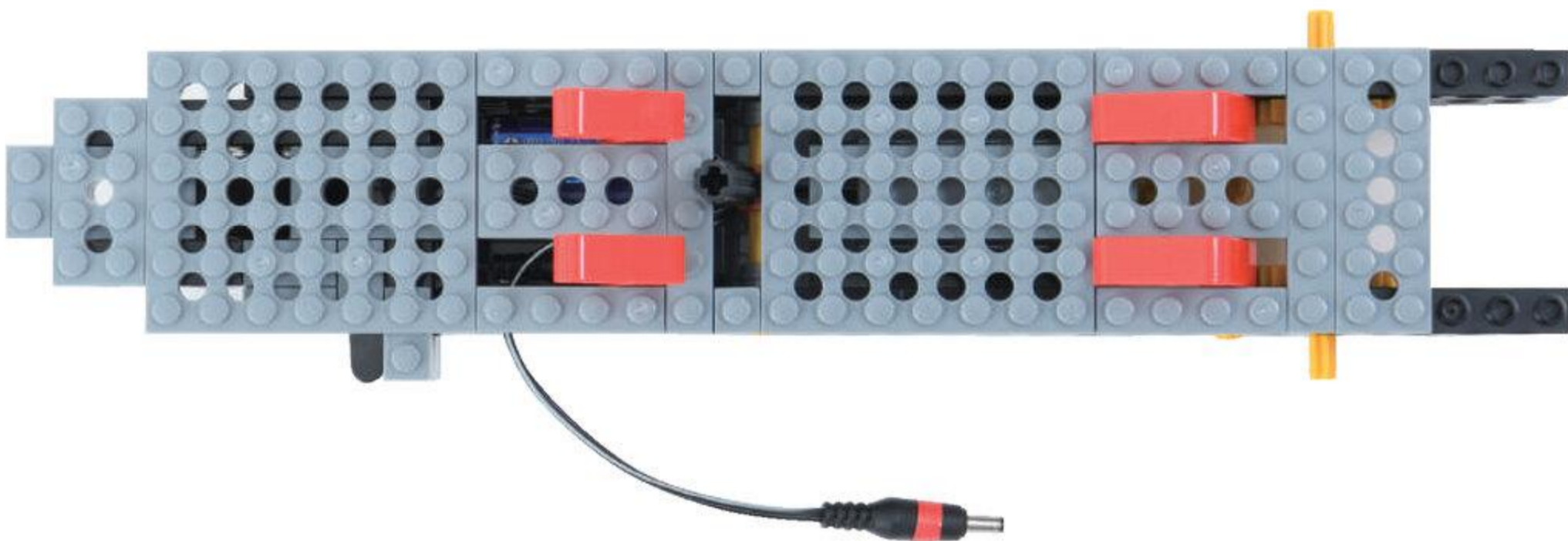
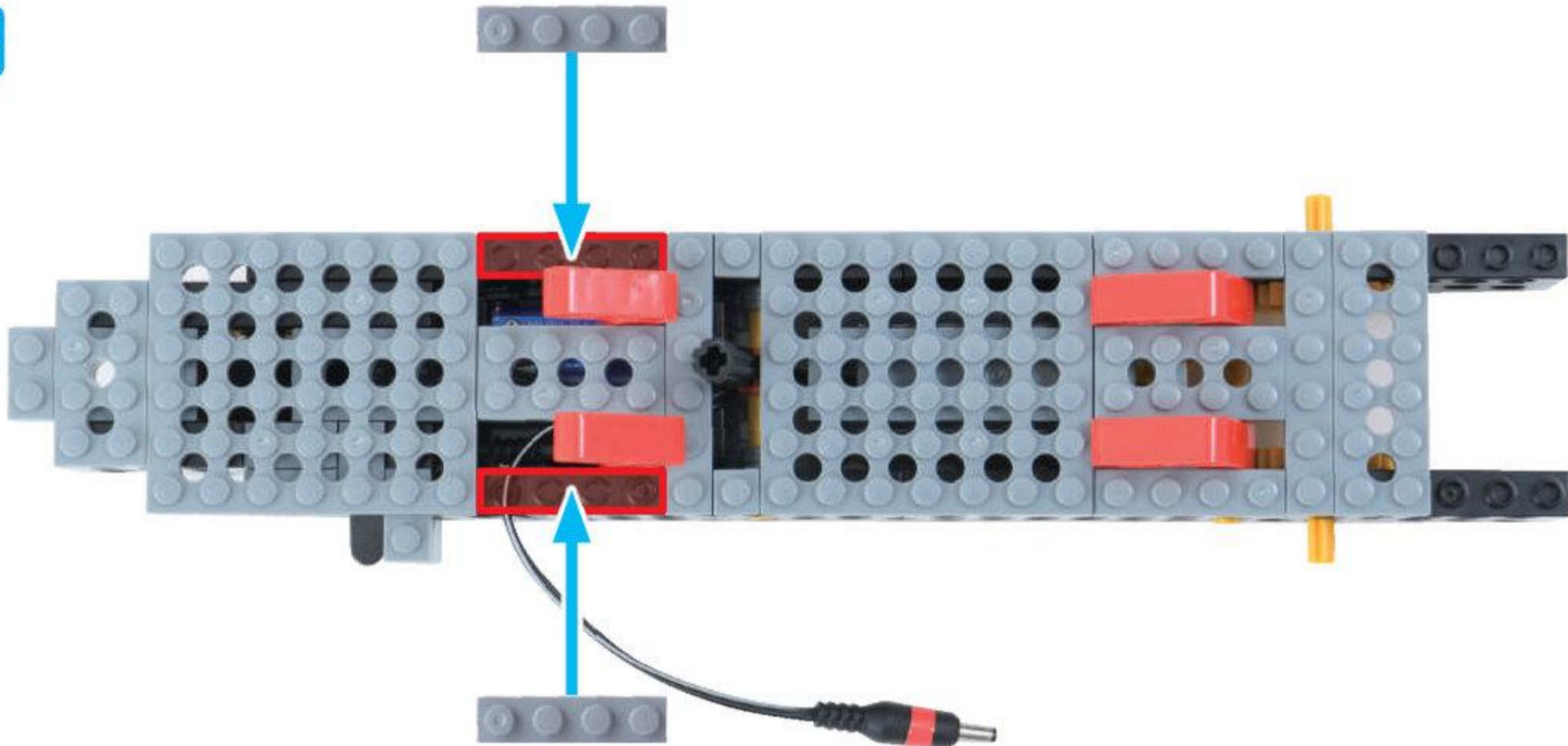

ふね(まえ)が
かんせい!



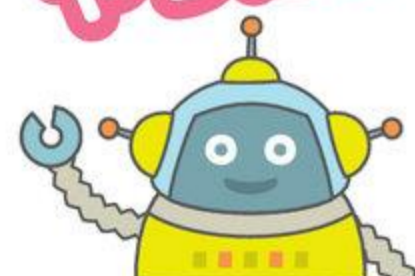





やったね!



3 ふね (うしろ)

めやす 10 ぶん



ふっしゅ ブッシュ 2こ  しゃふとよん ぽち シャフト 4 ポチ 1こ  ていじょいんと T ジョイント 1こ 	ながさに ちゅうい	しゃふとじょいんと シャフトジョイント 1こ  くるしゃふと いてんこ ぽち 黒シャフト 1.5 ポチ 1こ  みじかい   ながい  
--	--------------	---

1

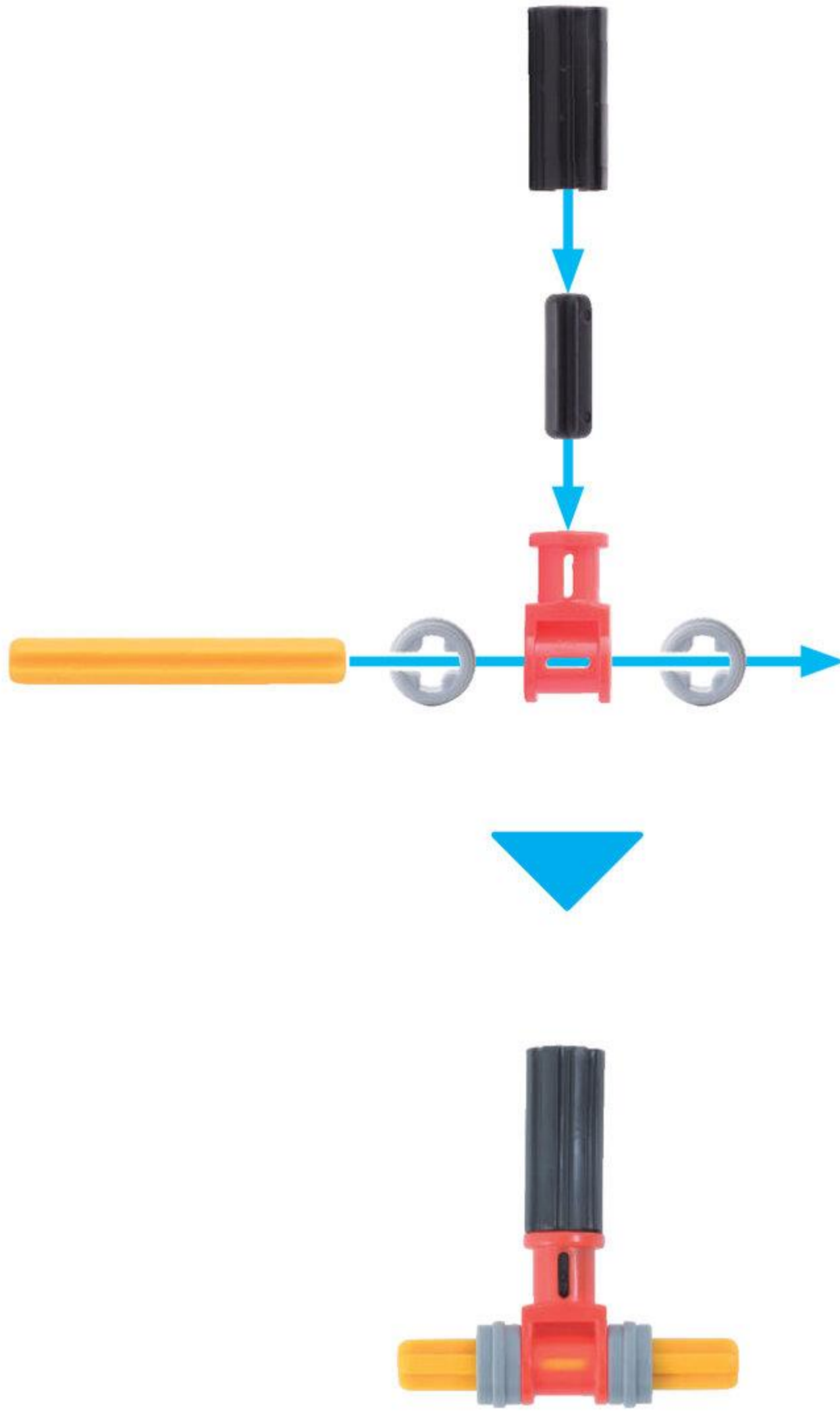

びいむよんぼち
ビーム 4 ポチ 2こ



びいむろくぼち
ビーム 6 ポチ 2こ



2

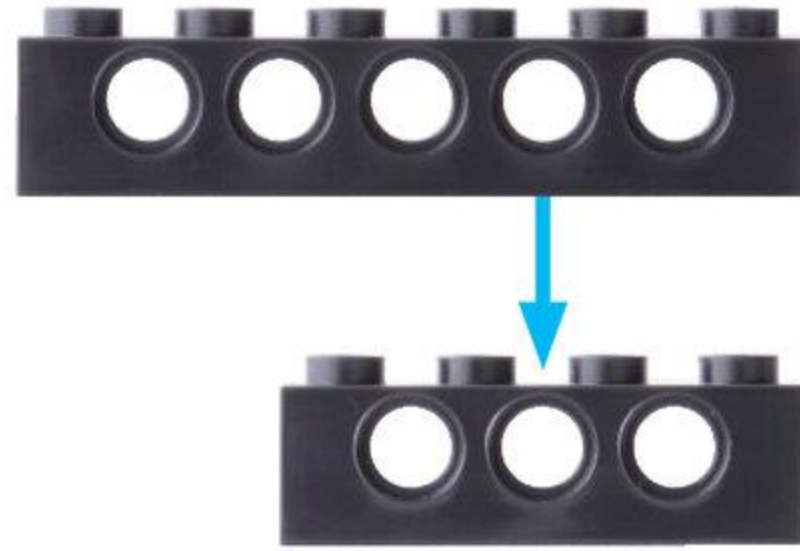
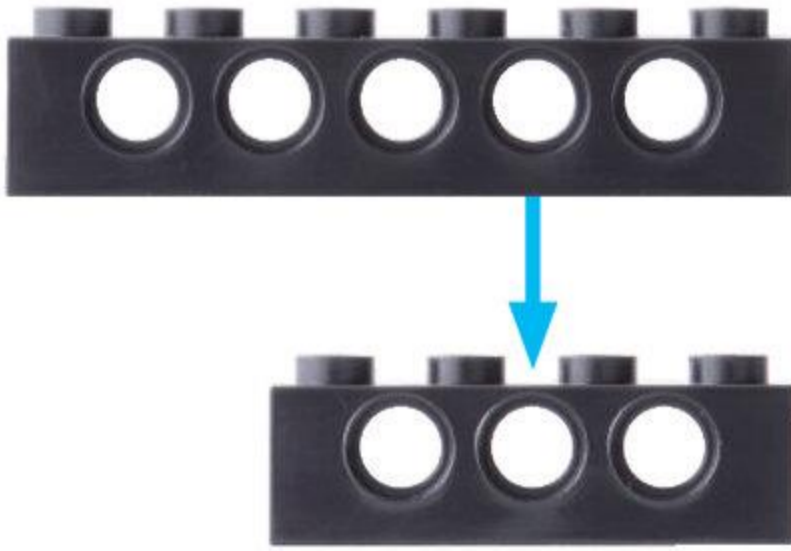

ほそぶれえとよん ぼち
細プレート 4 ポチ 1 こ



ふとぶれえとろく ぼち
太プレート 6 ポチ 1 こ



3

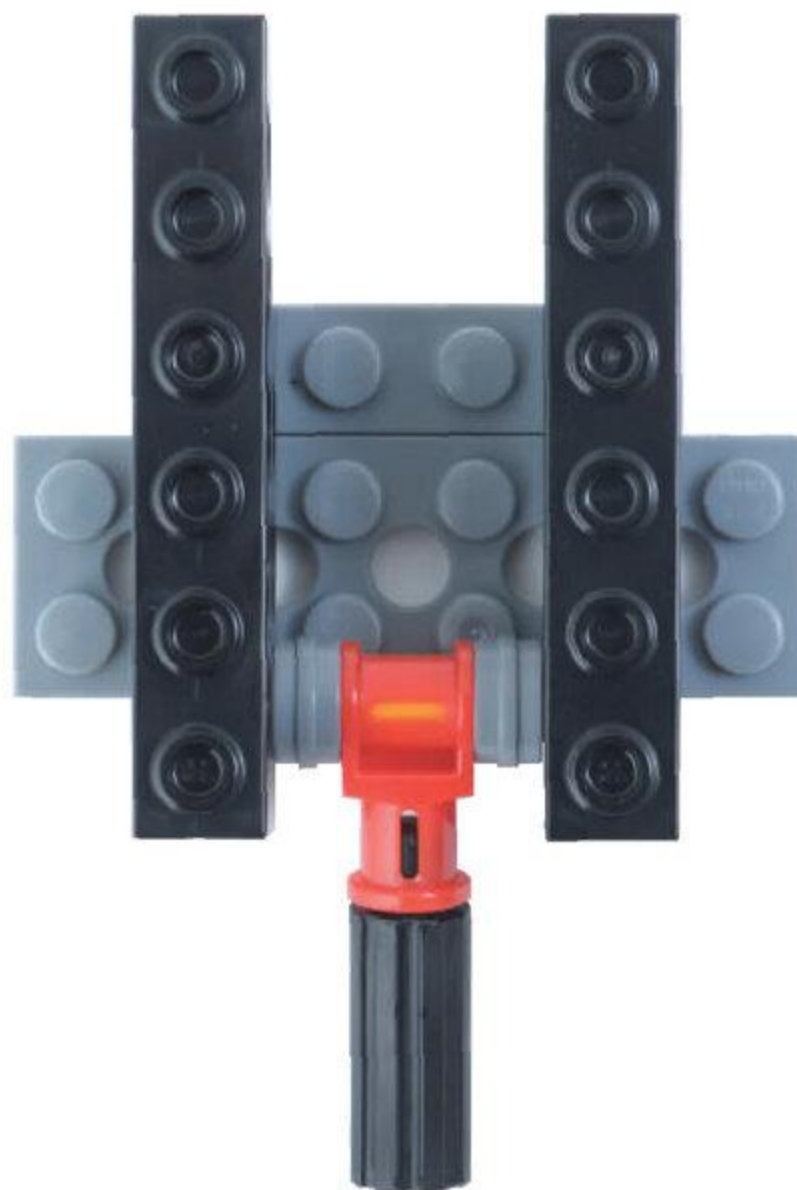
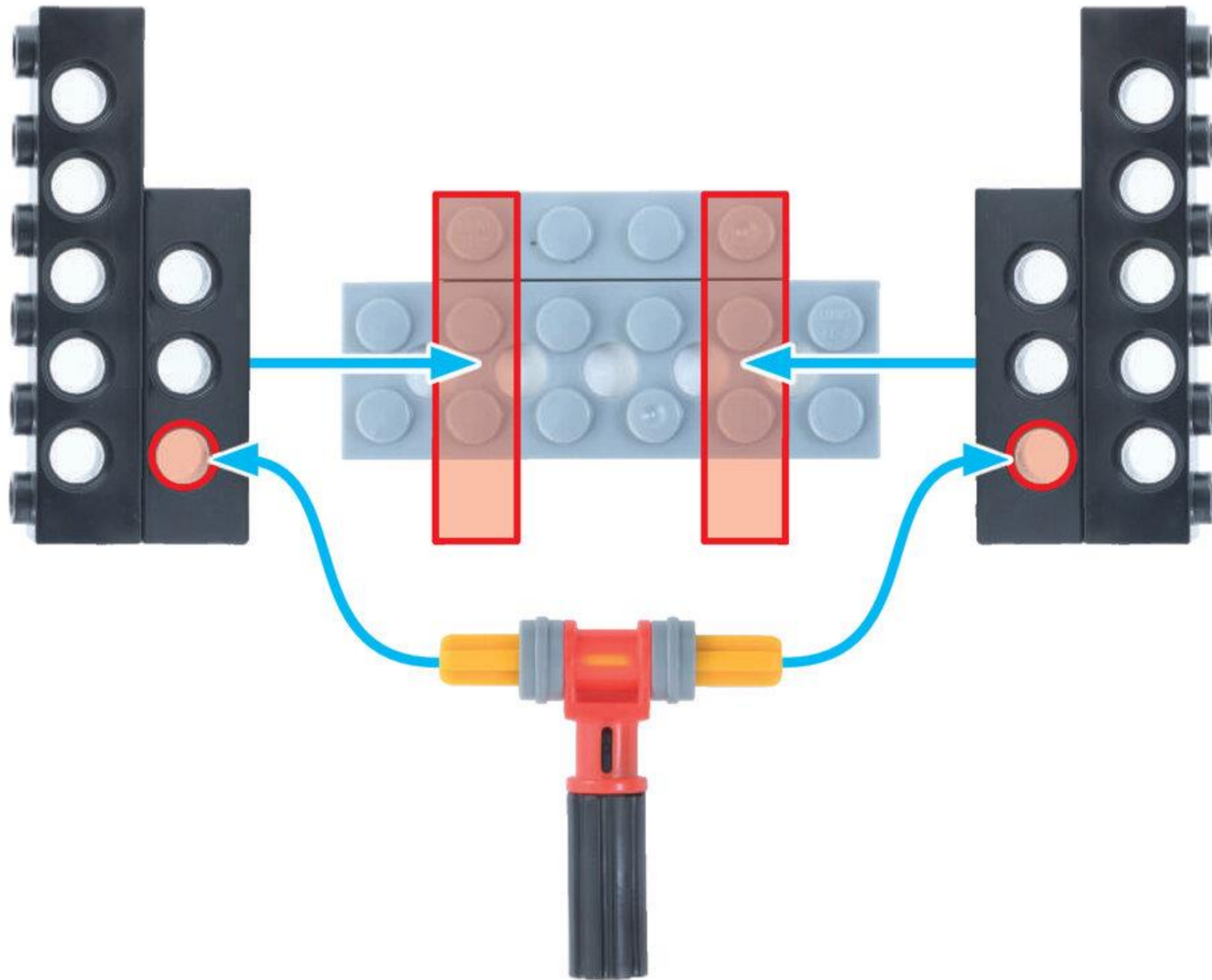

びいむよんぼち
ビーム 4 ポチ 2こ



ふとぶれえとよんぼち
太プレート 4 ポチ 1こ



ほそぶれえとよんぼち
細プレート 4 ポチ 1こ



ほそぶれえとにぼち
細プレート 2 ポチ 1こ



4

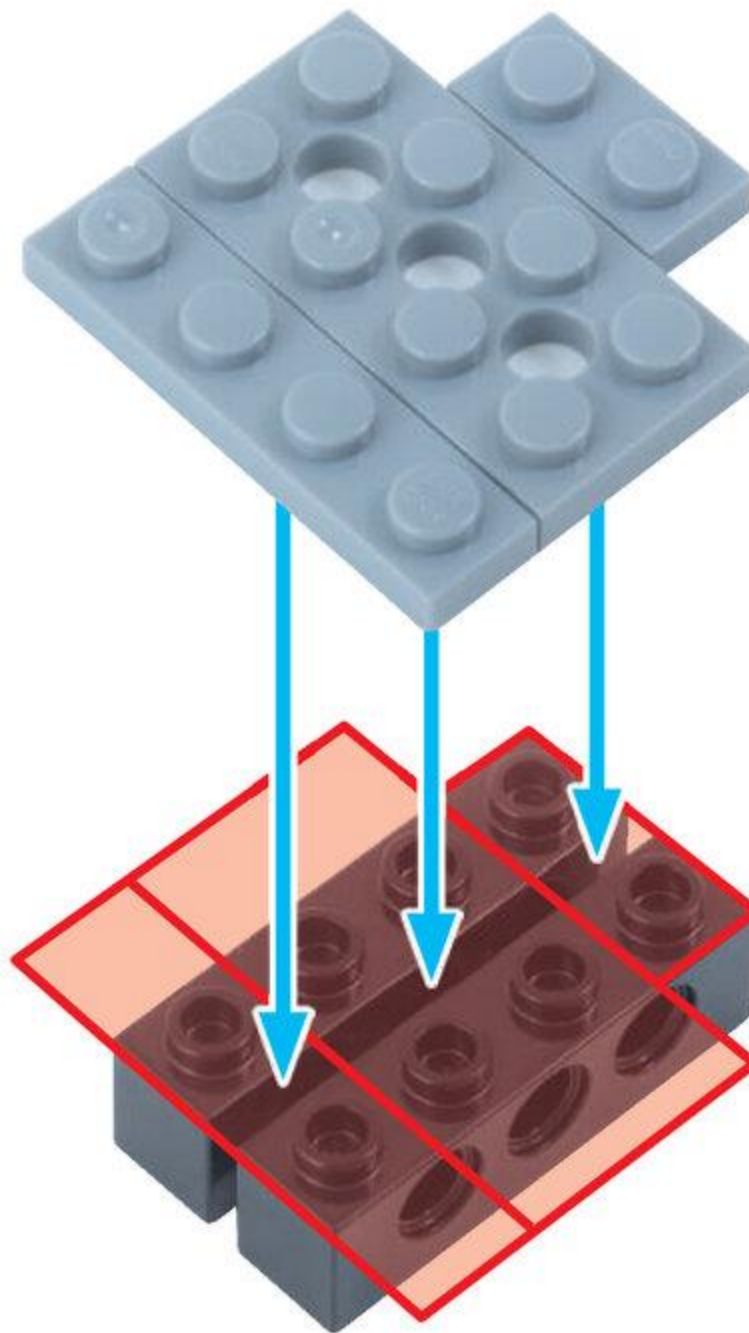

5

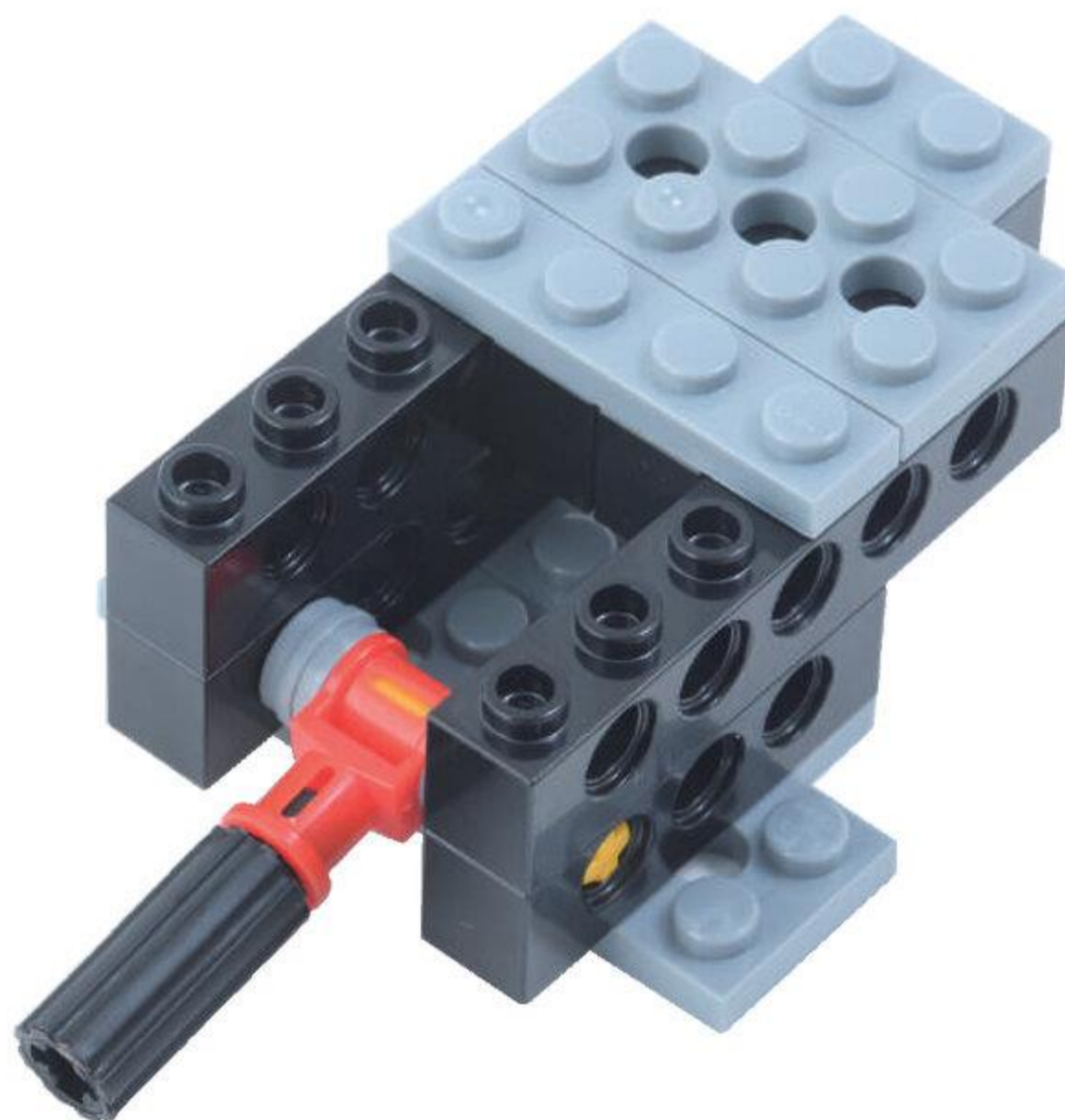
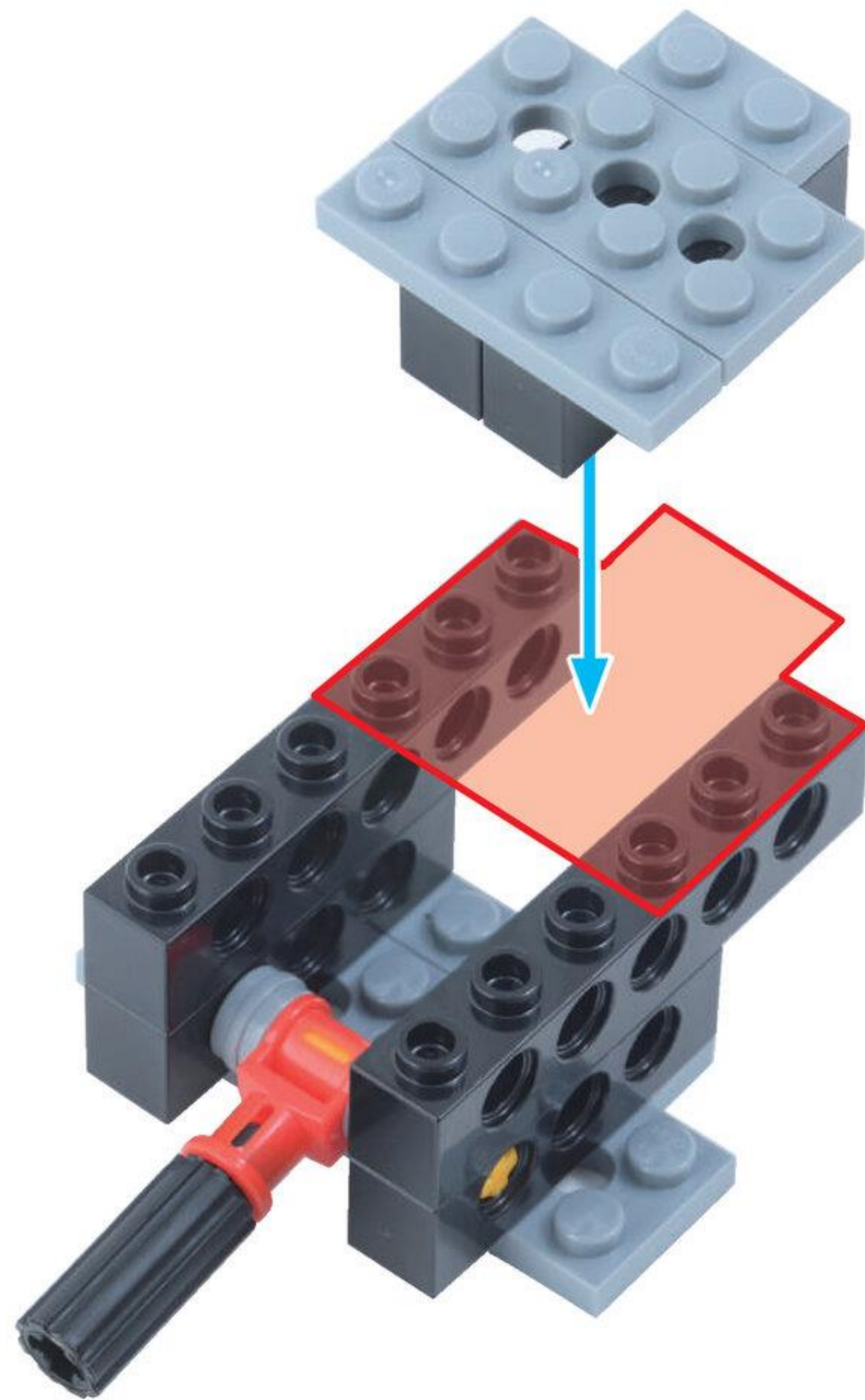

ほそぶれえとよんぼち
細プレート4ポチ 1こ



6

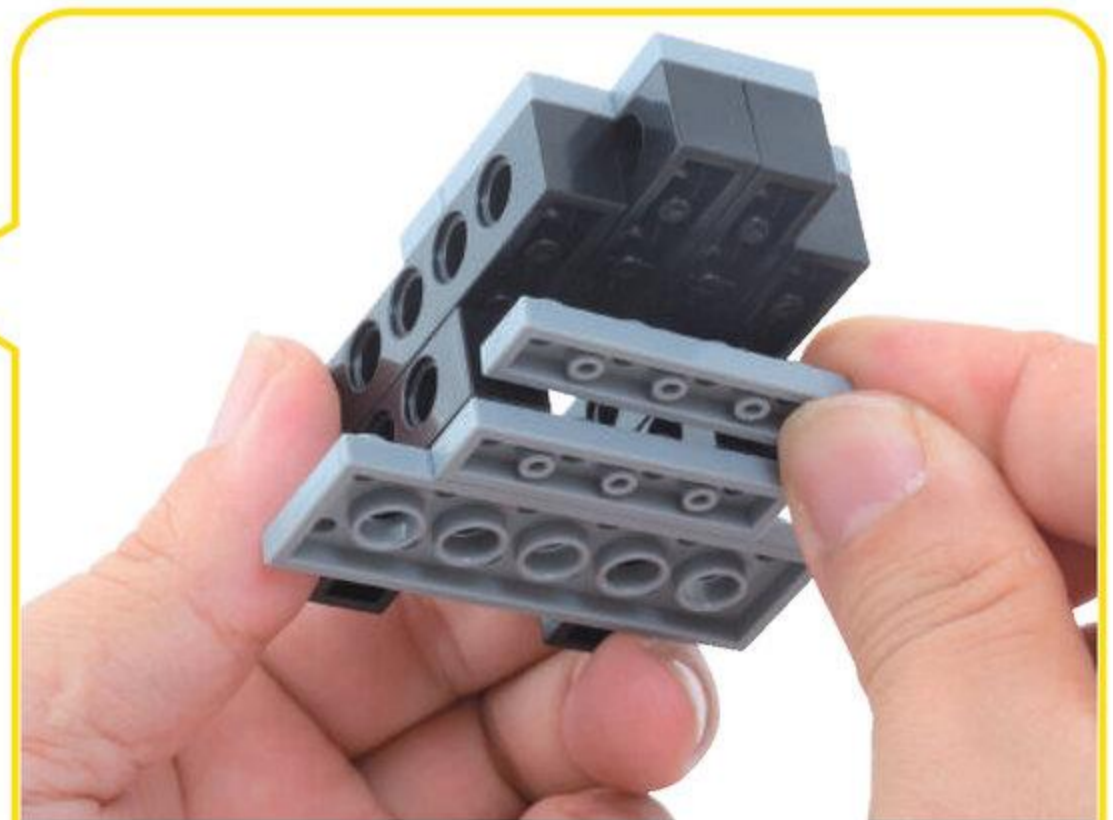
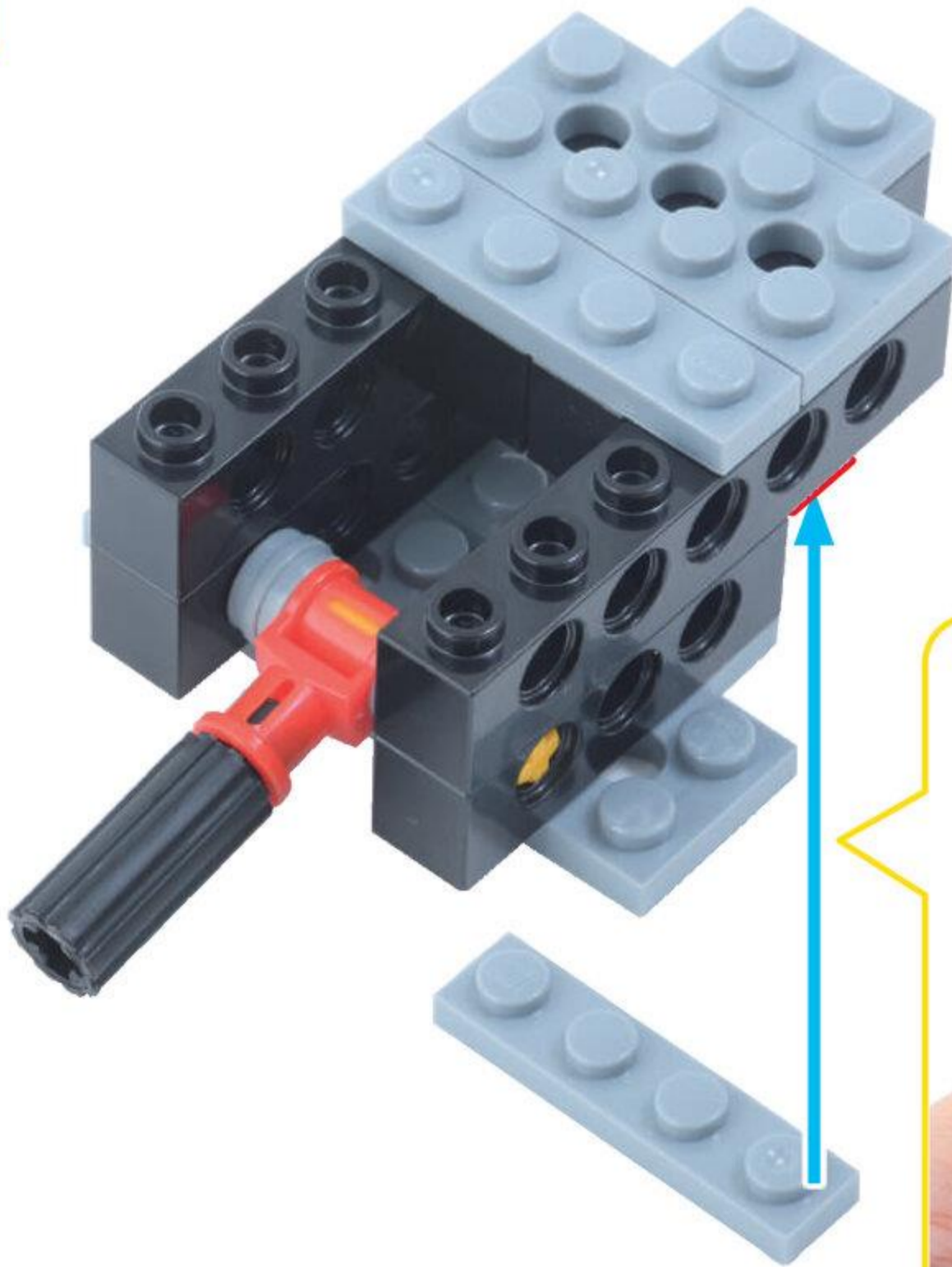

したから とりつけるよ

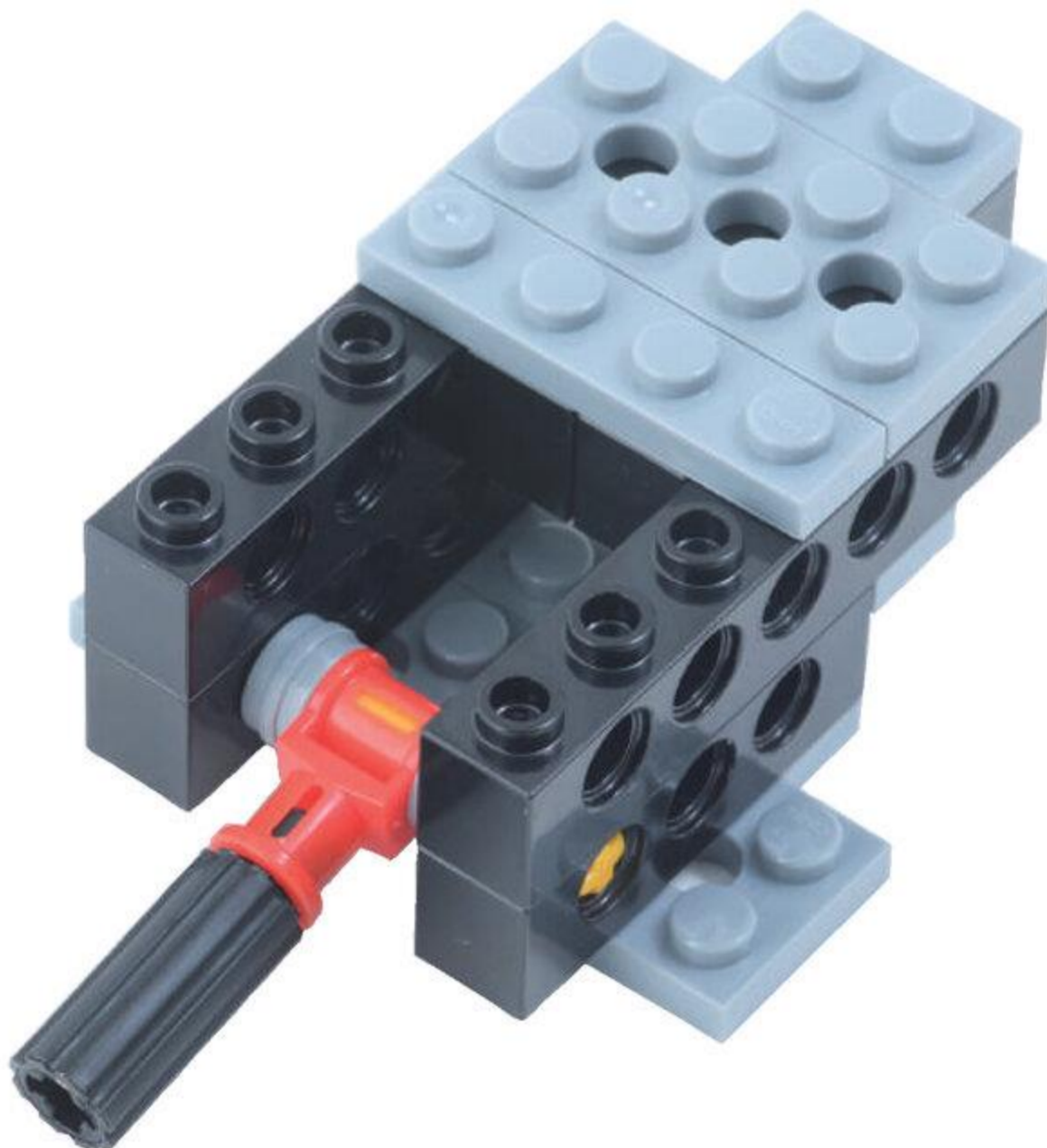

7

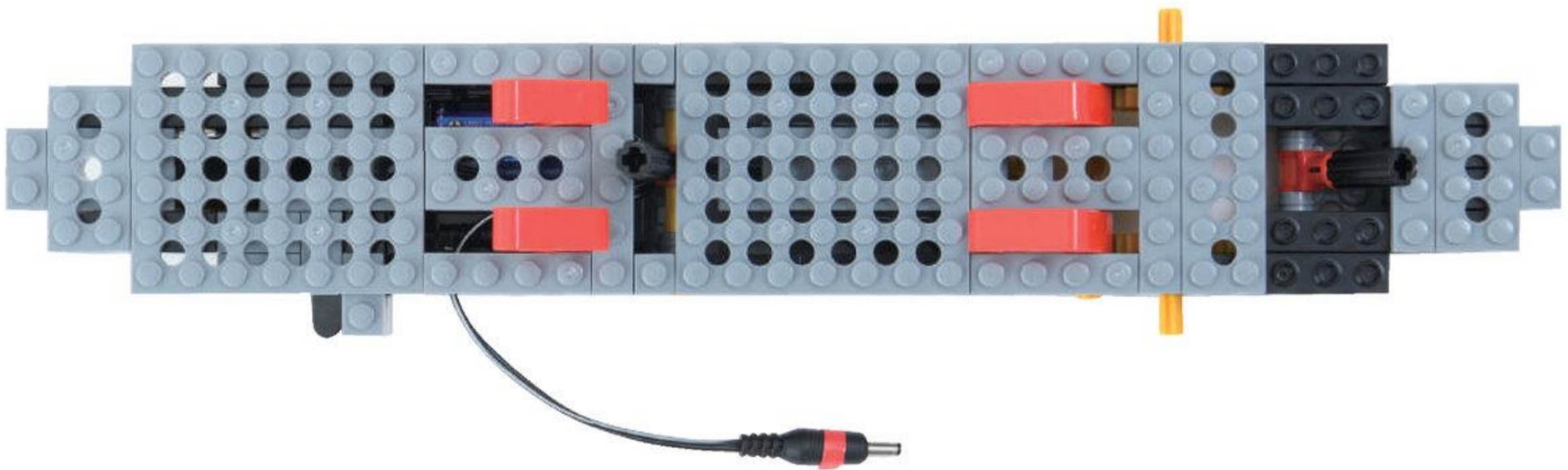
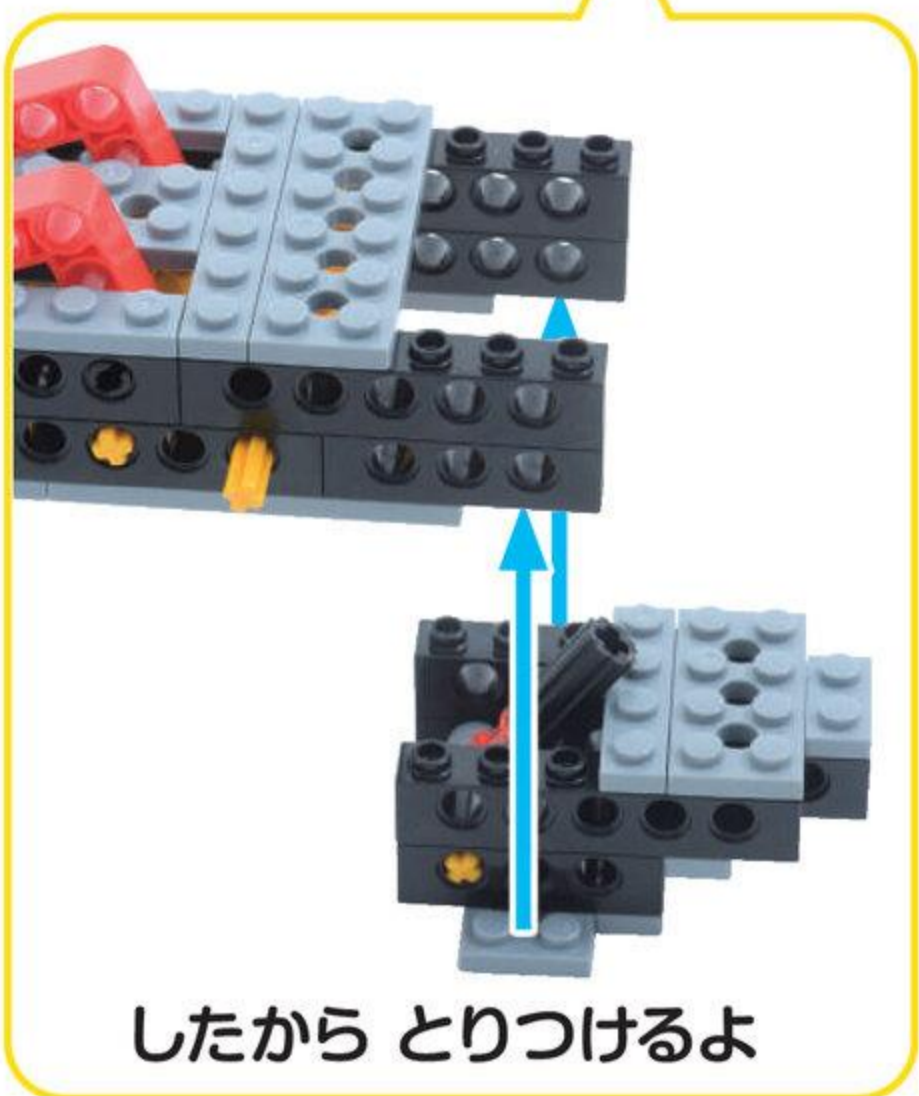
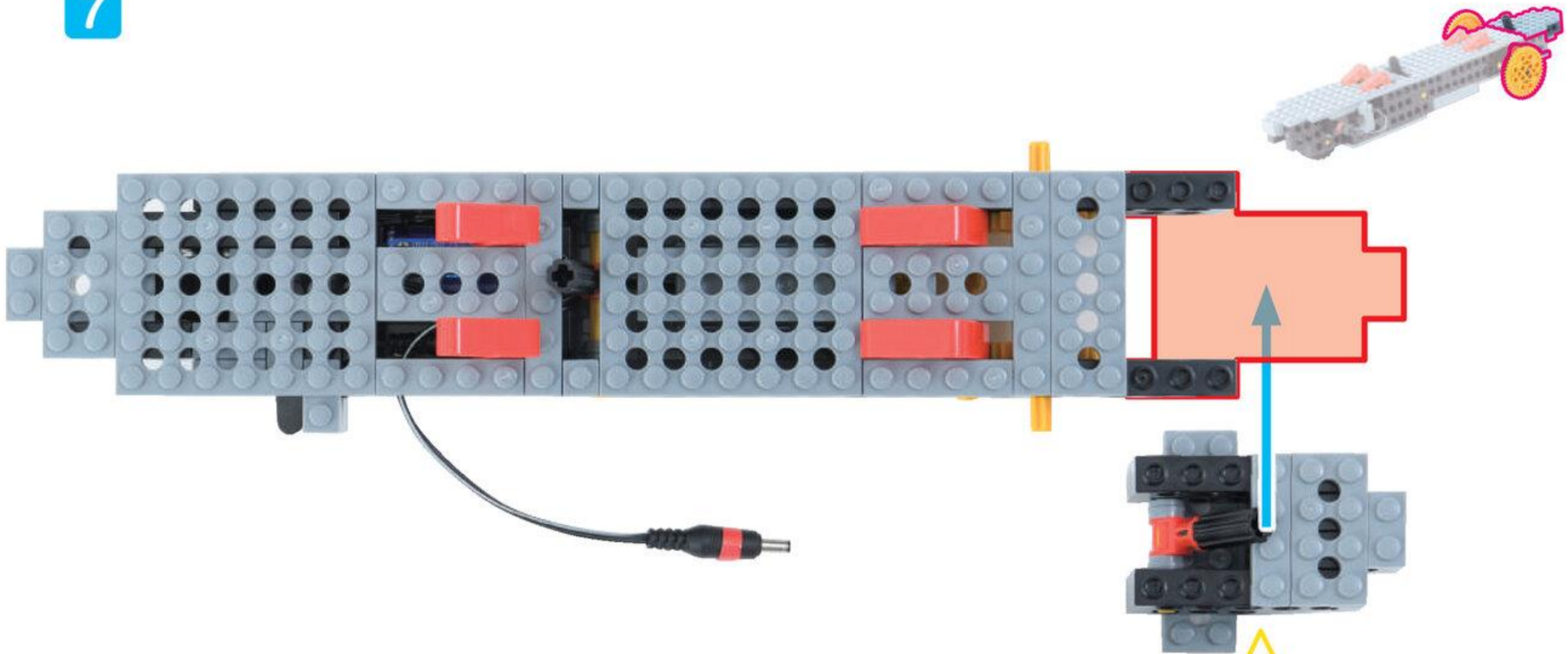

ふとぶれえとろくぼち
太プレート6ポチ 1こ



ほそぶれえとにぼち
細プレート2ポチ 2こ



8

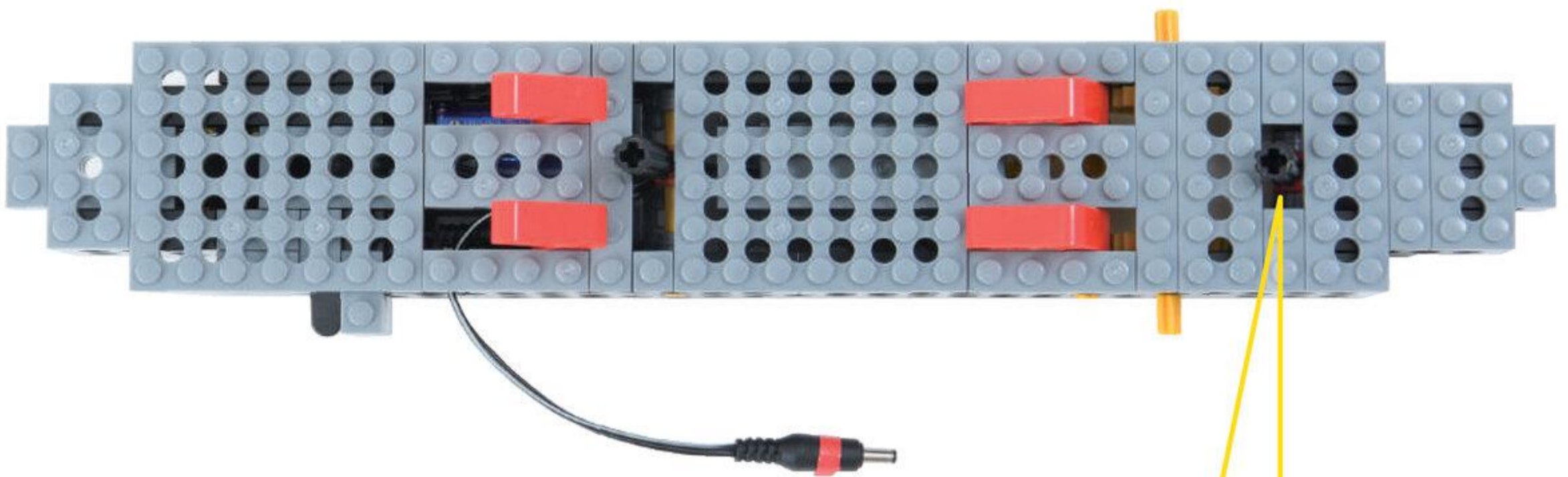
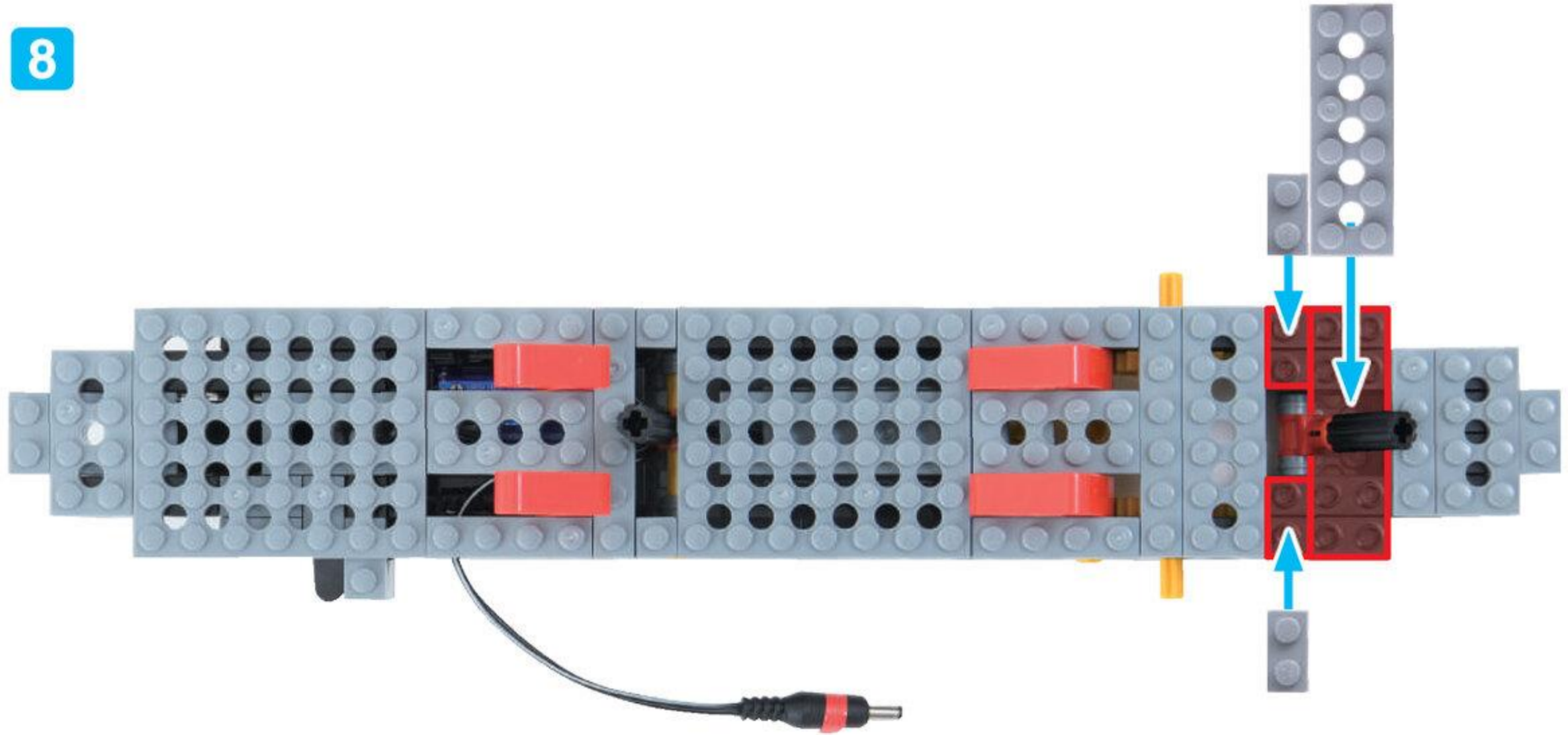

しゃふとじょいんと
シャフトジョイントのむきにちゅうい



ぎあえる
ギア L 2こ

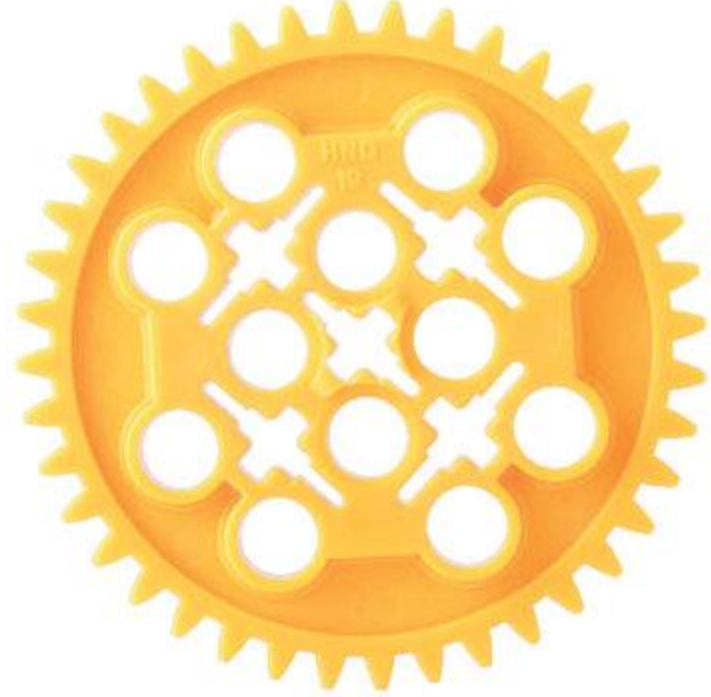

くろしゃふとにほち
黒シャフト 2 ポチ 2こ



○ ながい
× みじかい

ろっどさんあな
ロッド 3 アナ 2こ

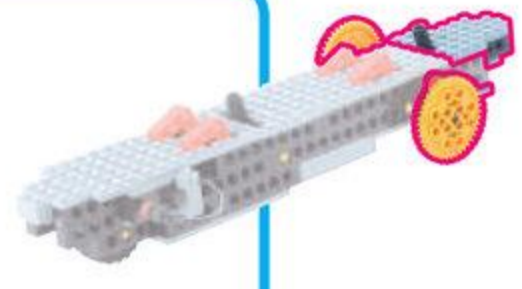

9

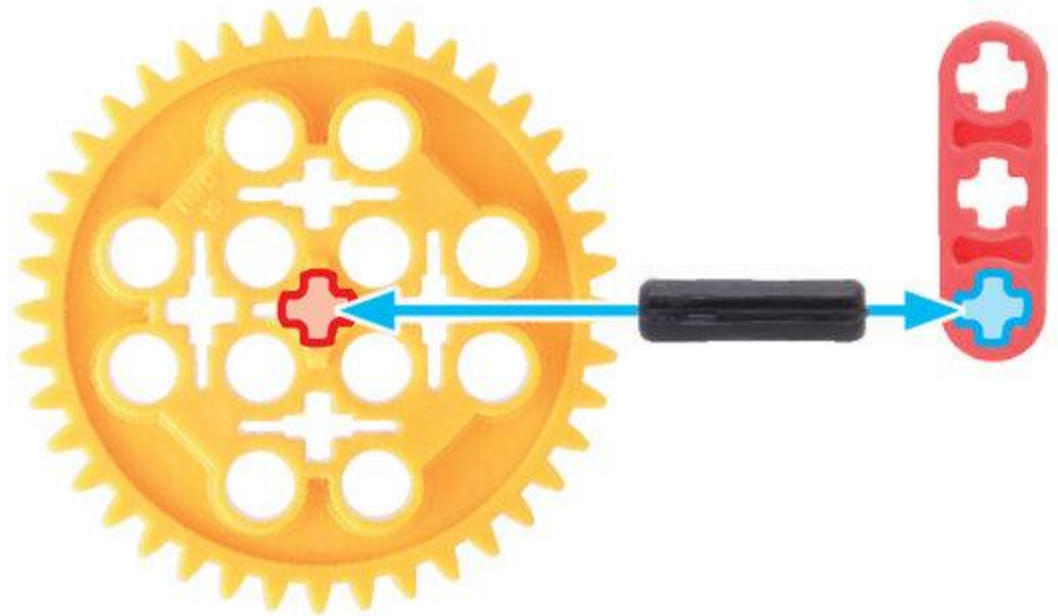
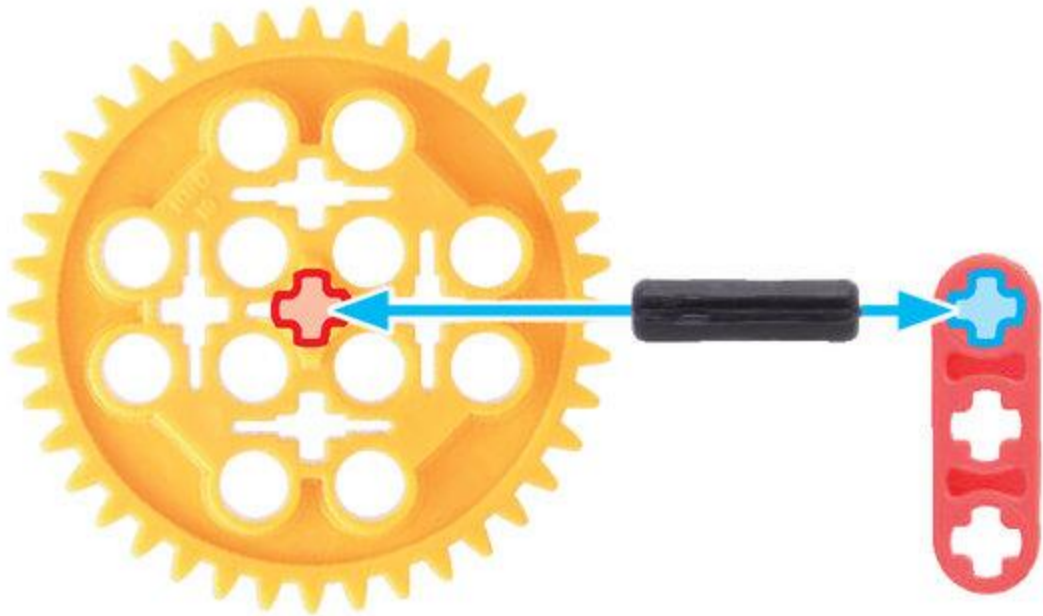

10

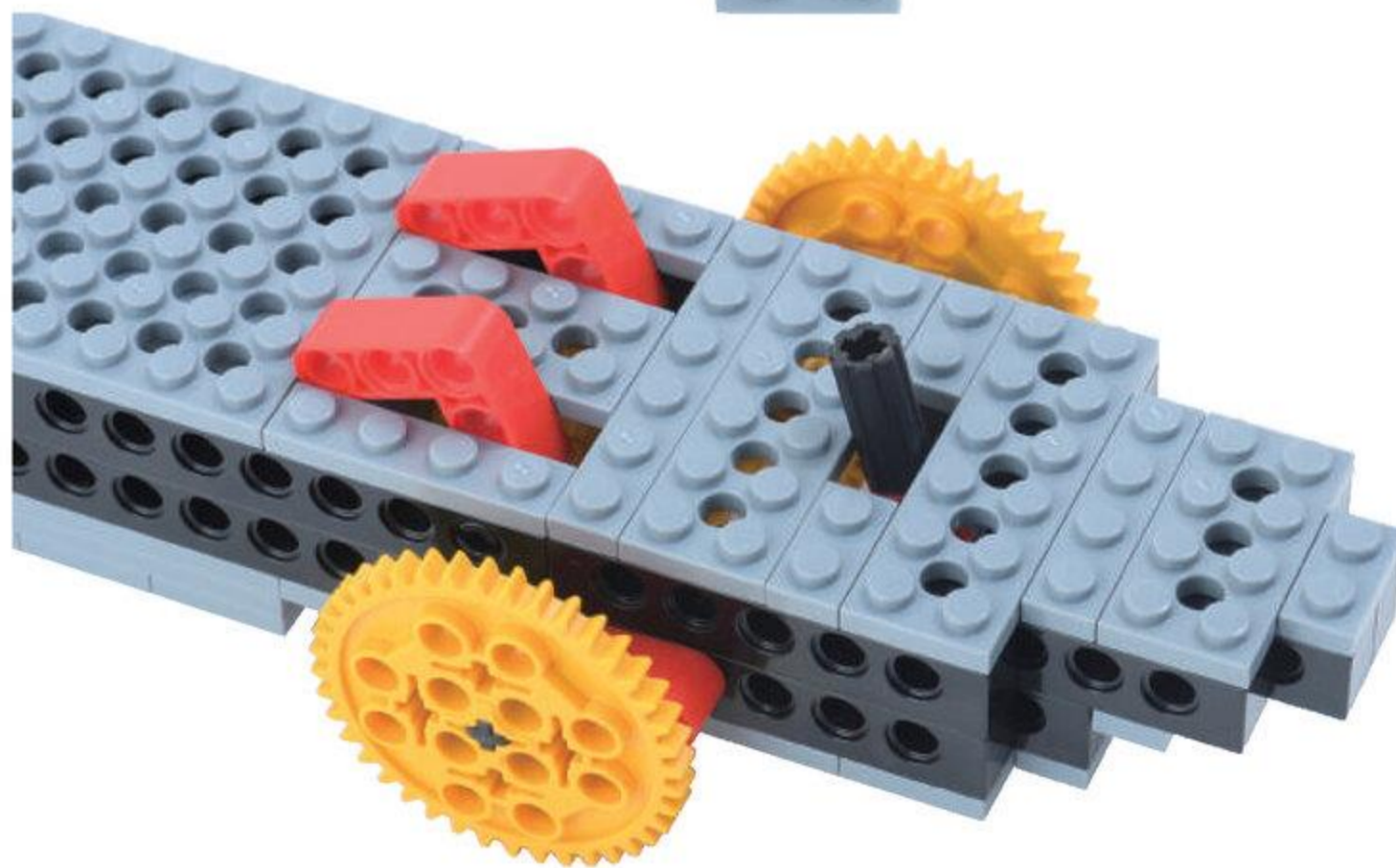
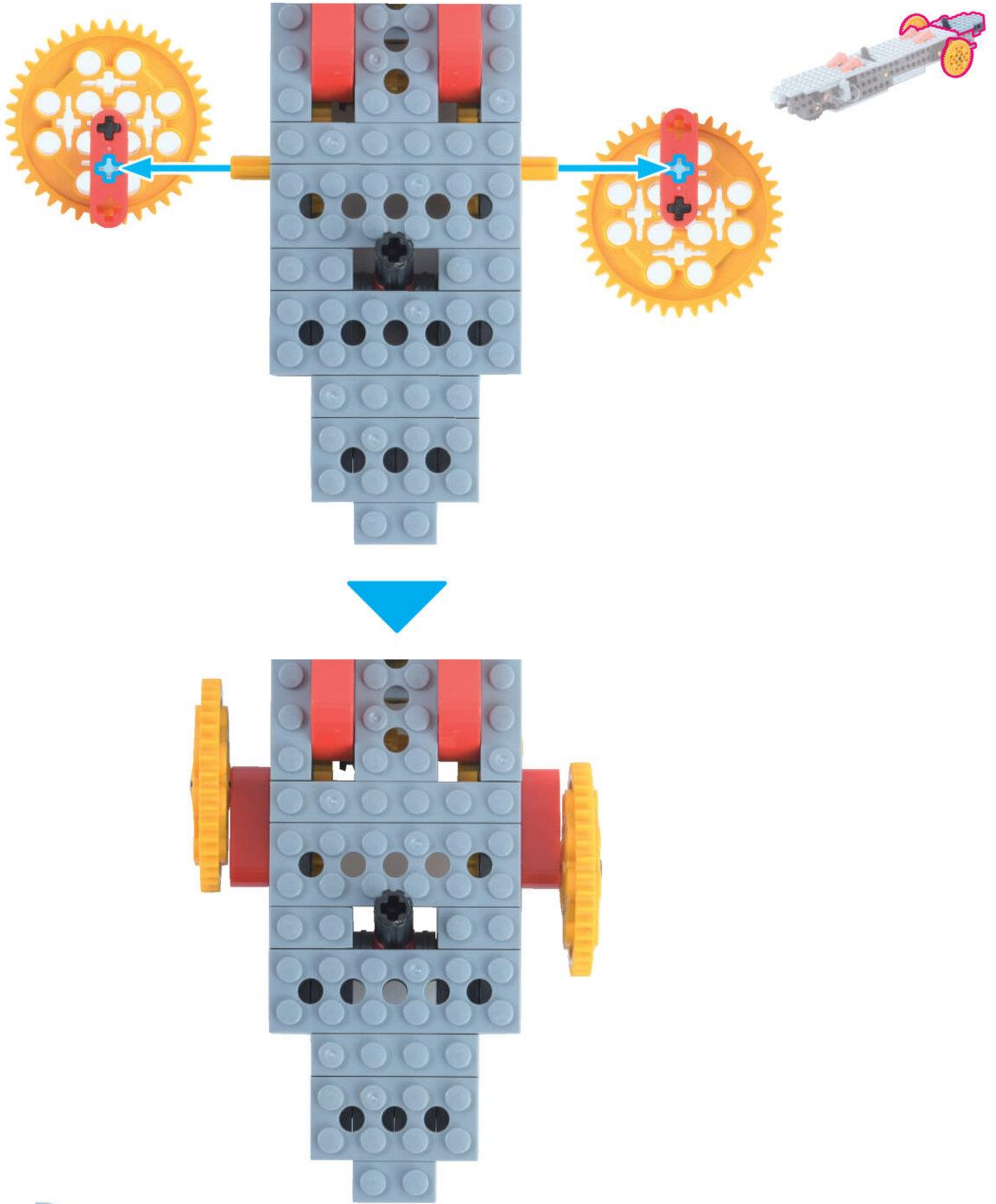

ふね (うしろ) が
かんせい!

やったね!

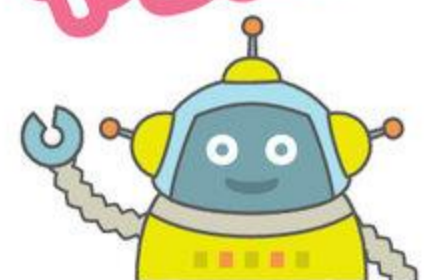

ロボットをうごかさう

めやす 10 ぶん

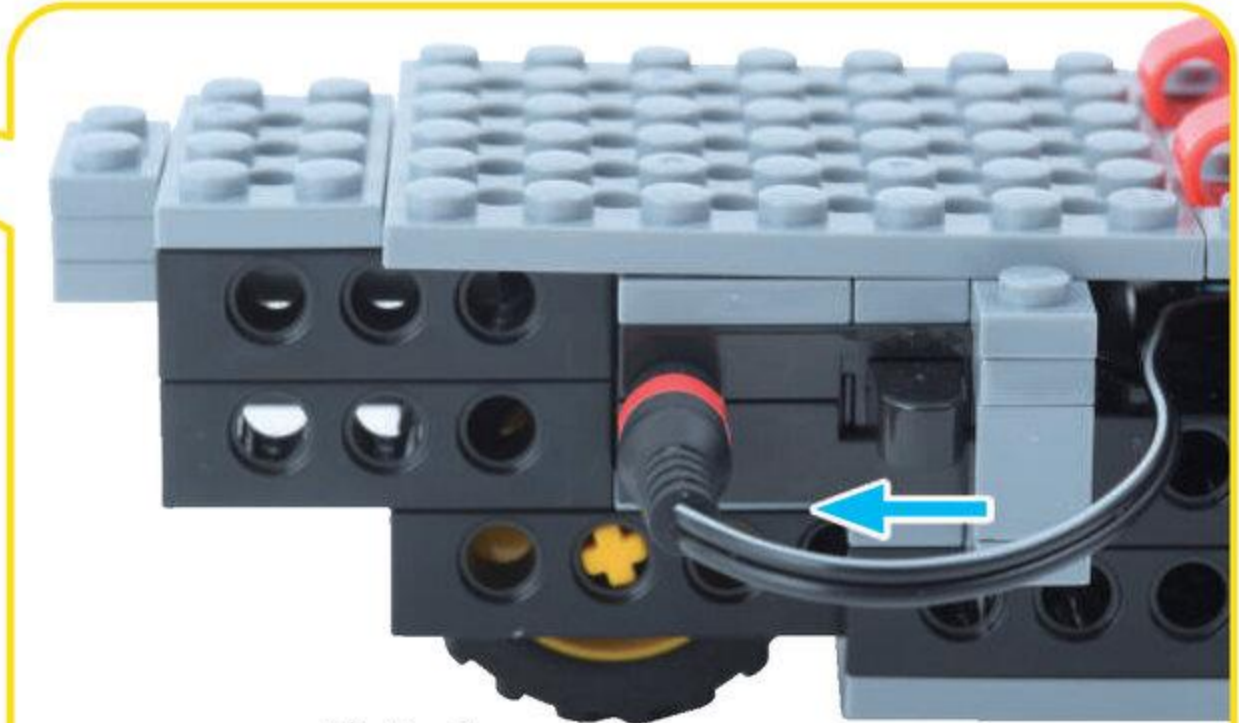
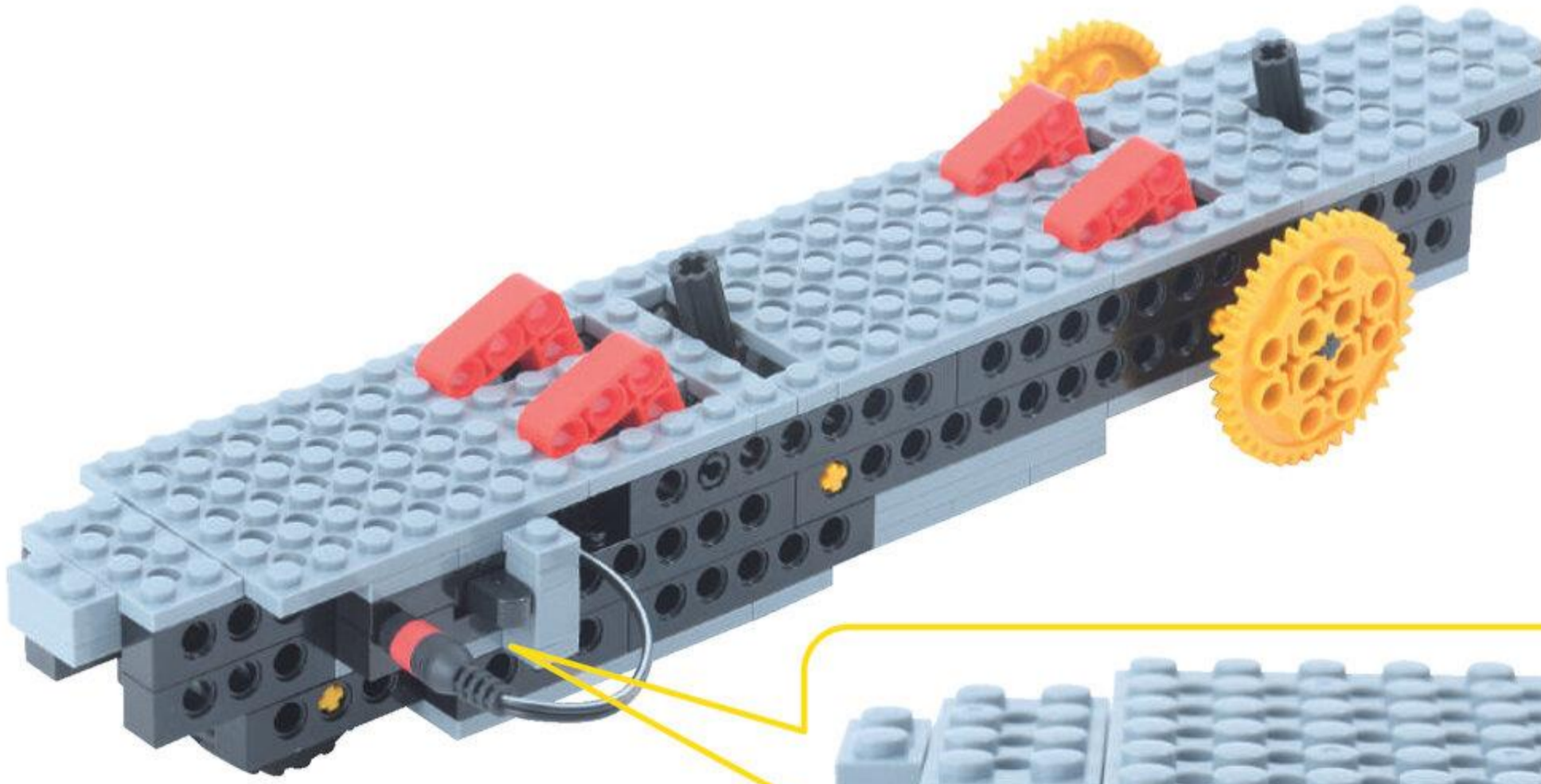

ぶらぐ
プラグをさしこんだら
やじるしのむきに
すいっち
スイッチをいれよう

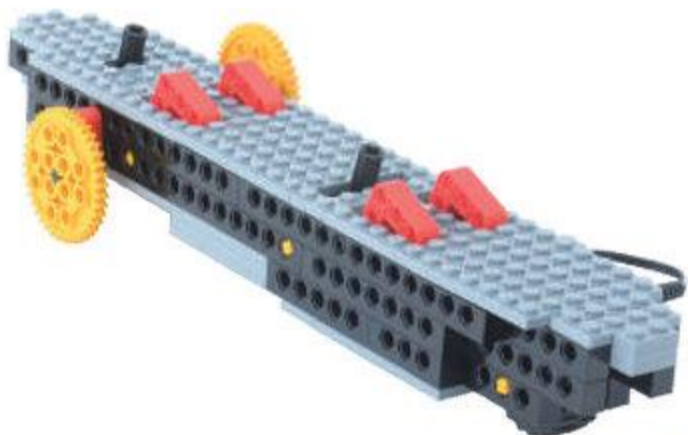

ふねはゆれながら
すすんだかな

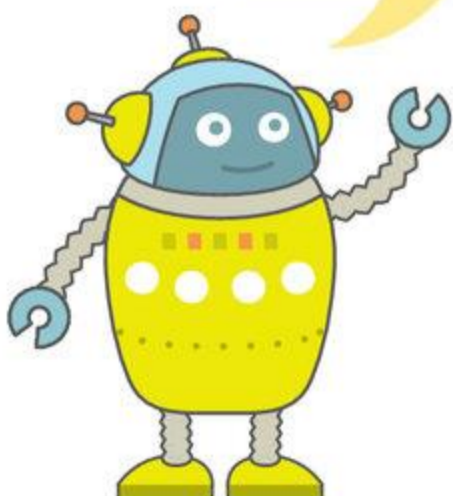

Q1 このパーツの ばあつ 名まえは どれかな?



- ・ くろすじょいんと クロスジョイント
- ・ しゃふとじょいんと シャフトジョイント
- ・ あなしゃふとじょいんと アナシャフトジョイント



Q2 あなしゃふとじょいんと アナシャフトジョイントに
とりつけられない ばあつ パーツは どれかな?



Q3 しゃふとじょいんと シャフトジョイントに **とりつけられる** ばあつ パーツは どれかな?



ロボットのきょうかしよ

プレプライマリーコース B

2

おやこで わんつう ワンツウ「かやっくん カヤックン」

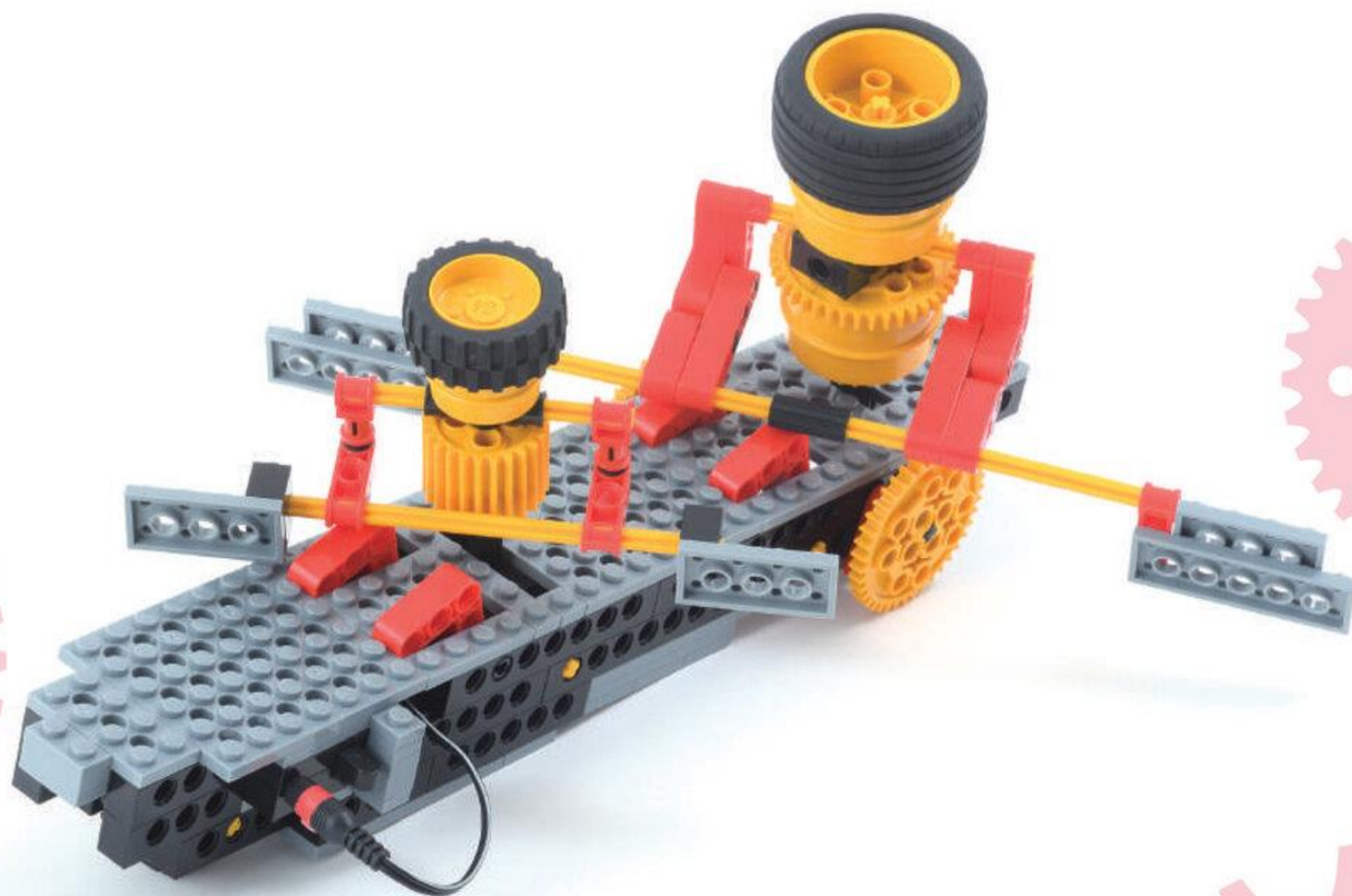

★だい2かい 2024ねん 9がつ にち

なまえ

もくじ

だい 2 かい

きょうの よてい	55	2ふん
くみたて		
1. おとな	56～65	80ふん
2. こども	66～72	
3. おとなと こどもの とりつけ	73	
<small>ろぼっと</small> ロボットを うごかそう	74	
いぬをつくろう	75～83	
じゆうに かいぞう してみよう	83	
まちがい さがし	84	3ふん
かたづけ		5ふん

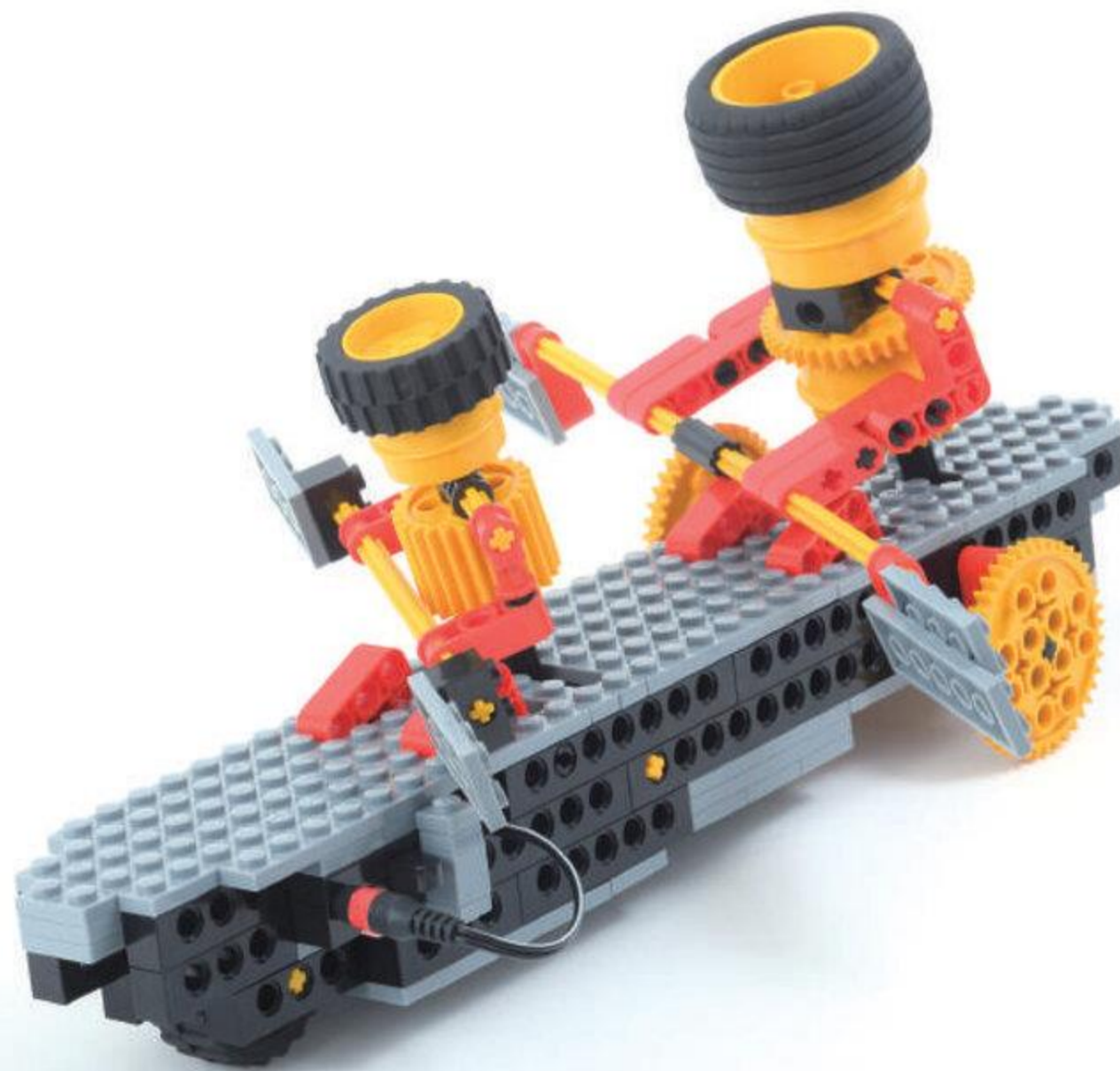

こんかいは ふねに のる
ひとをつくるよ!

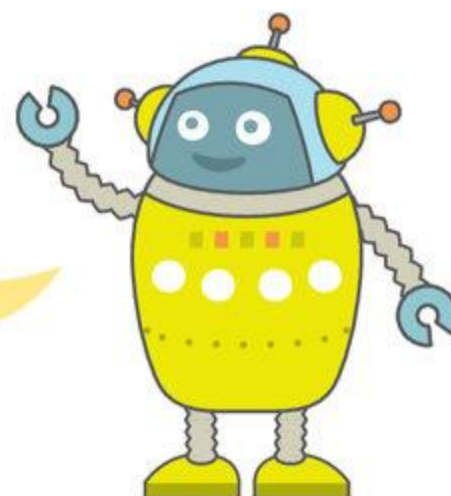

きょうの よてい

めやす 2 ふん

このじゅんばんでつくるよ!

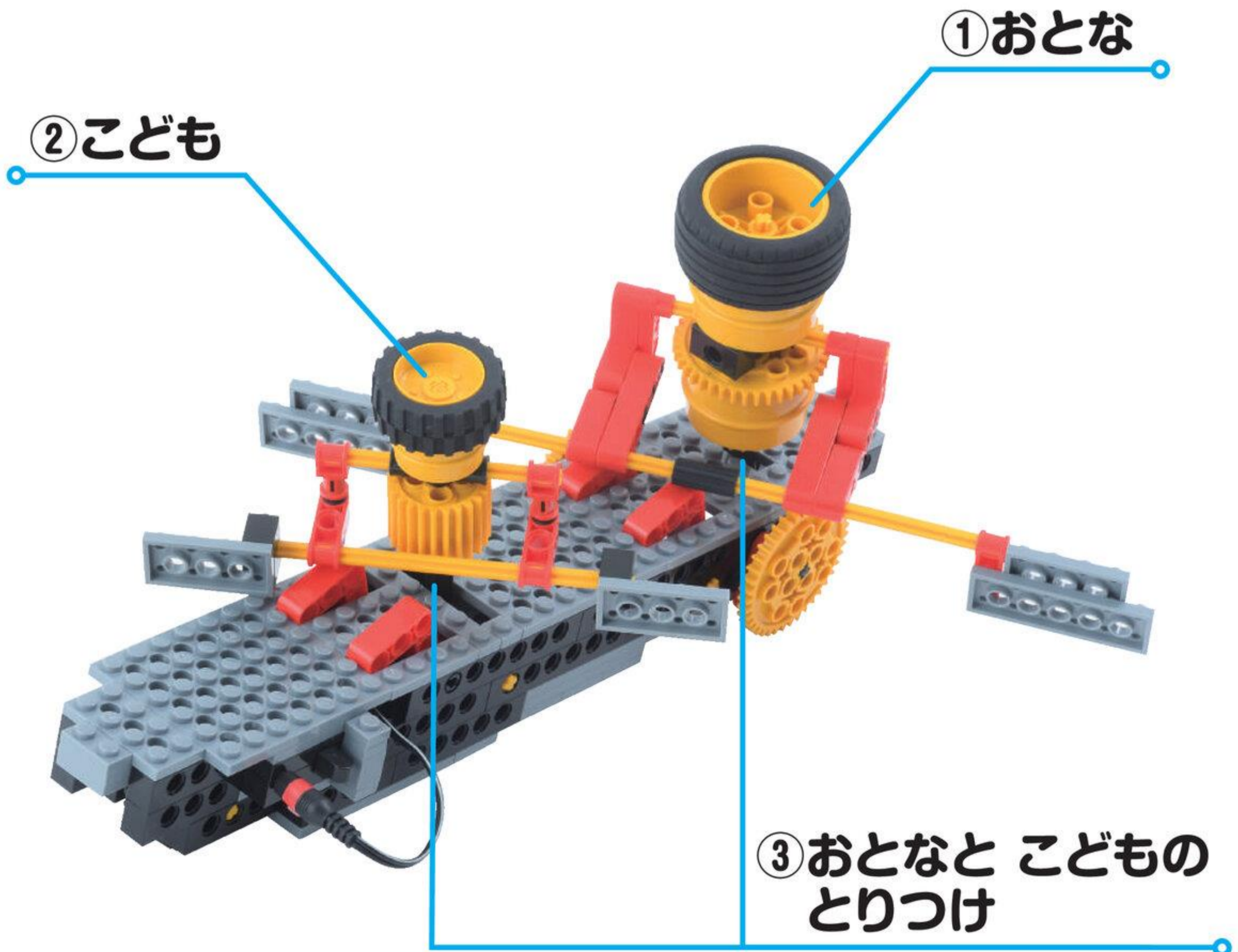

①おとな

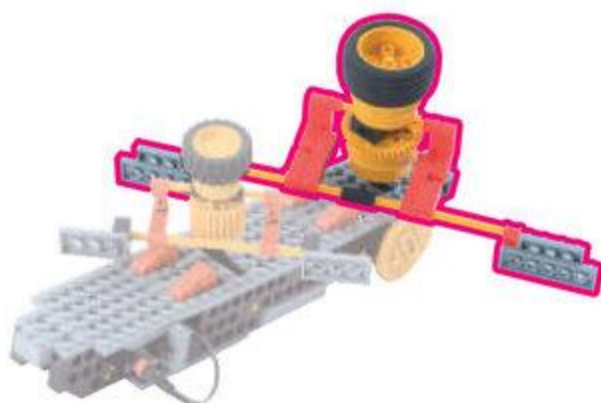

②こども



③おとなとこどものとりつけ

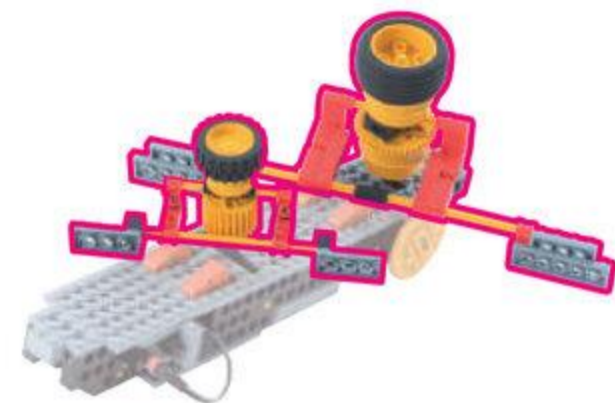

1 おとな

めやす 15 ぶん

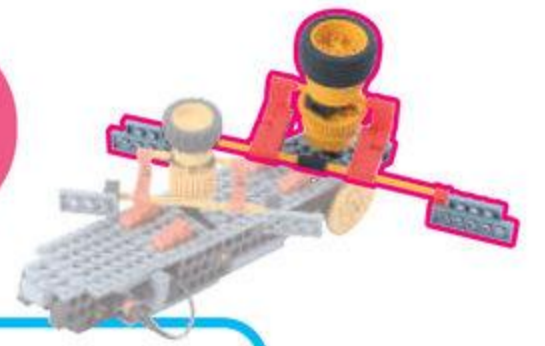

えろつど
Lロッド 2こ



へぐえす
ペグS 4こ



1

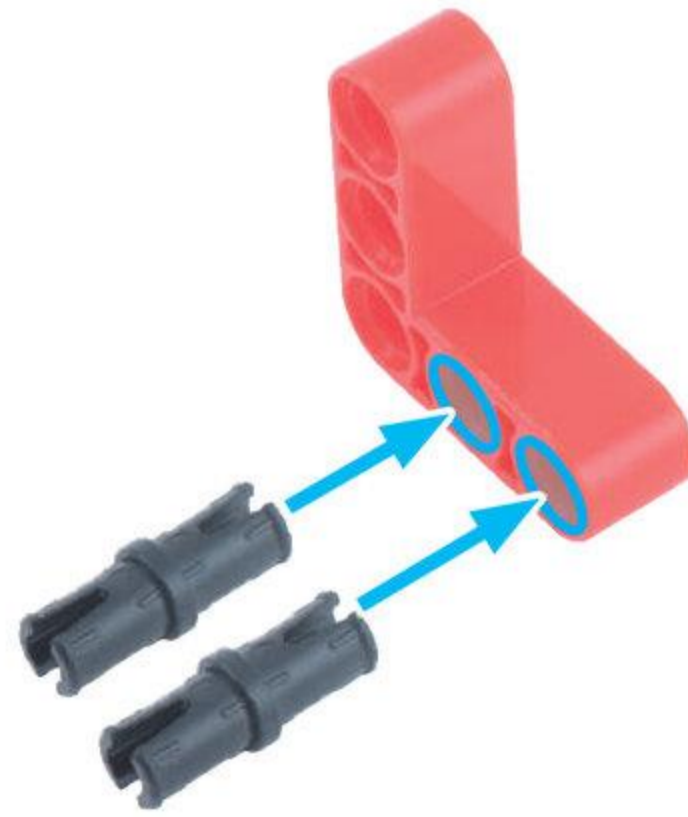
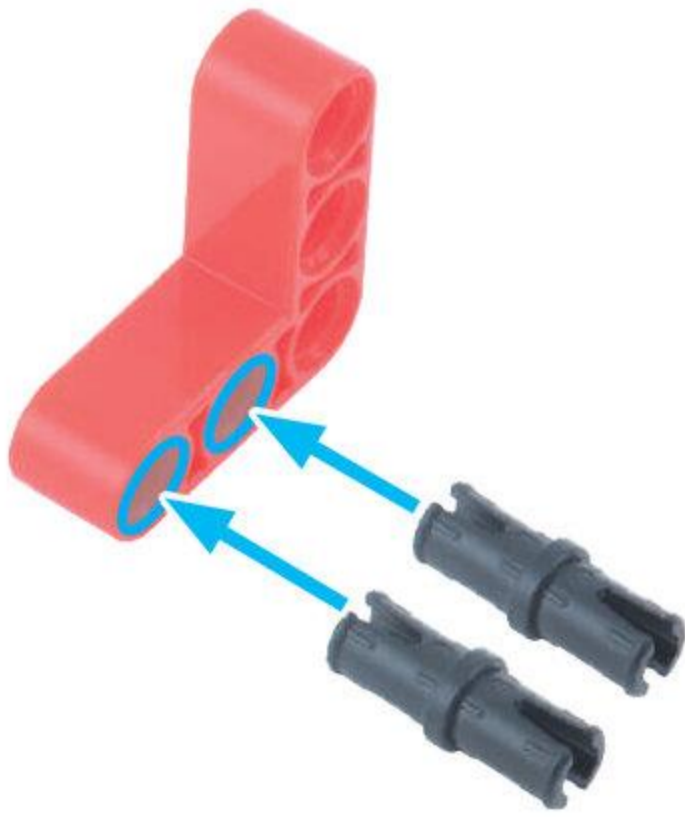

ろっどごあな
ロッド5アナ 2こ



くらんく
クランク 2こ

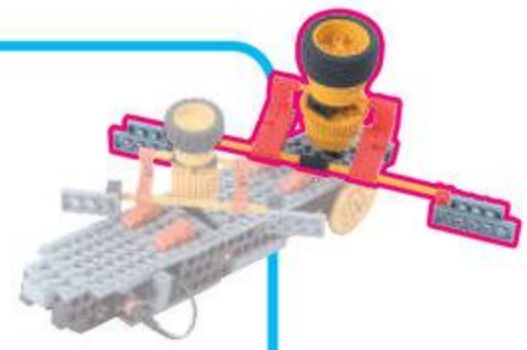

2

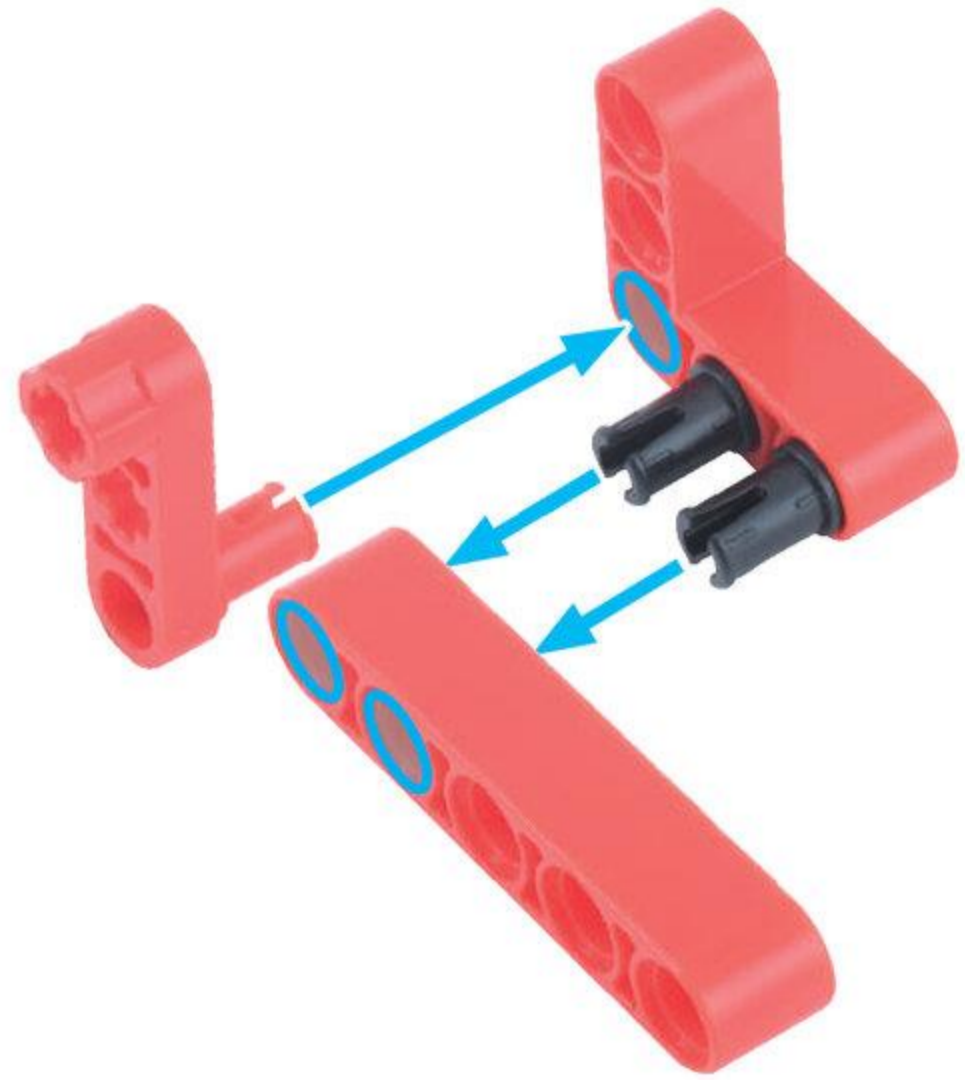
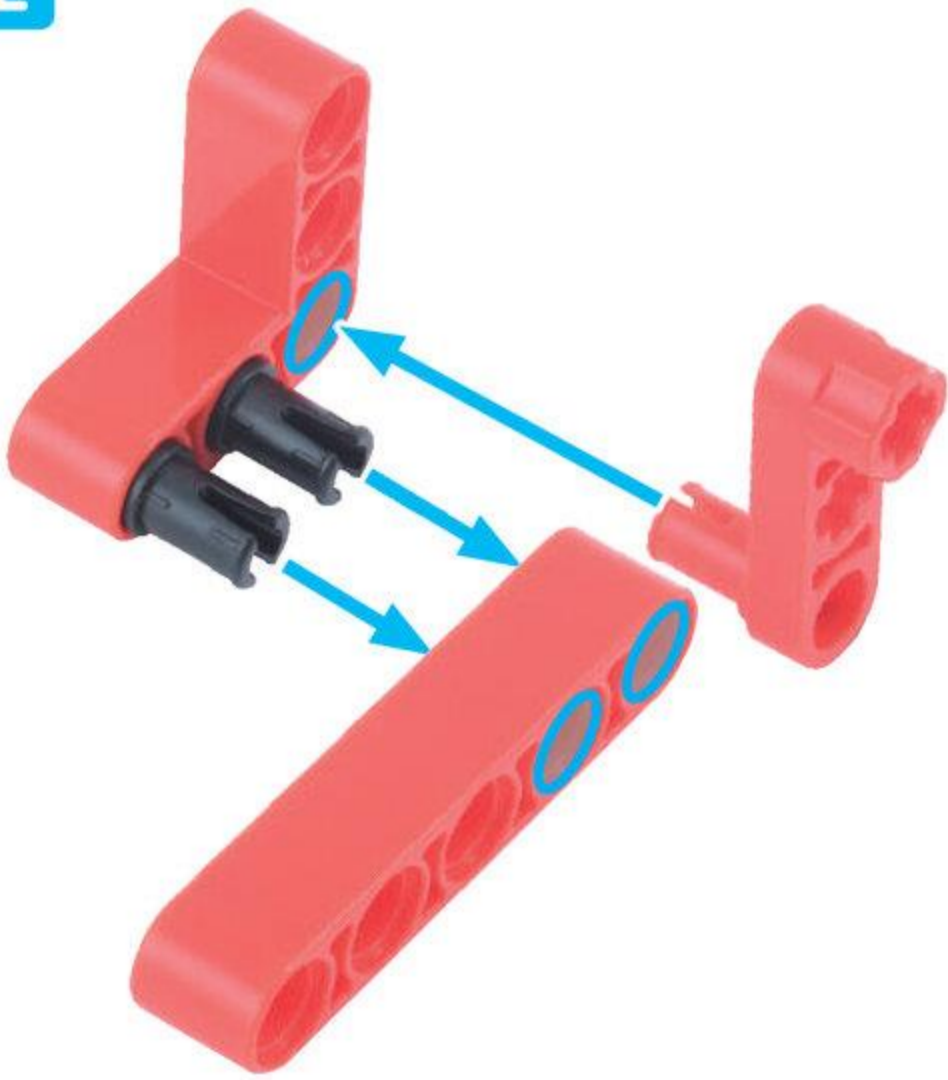

ろっどさんあな 2こ
ロッド3アナ



しゃふとペグ 2こ
シャフトペグ

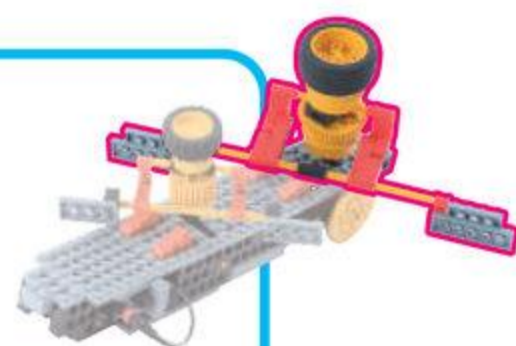

3

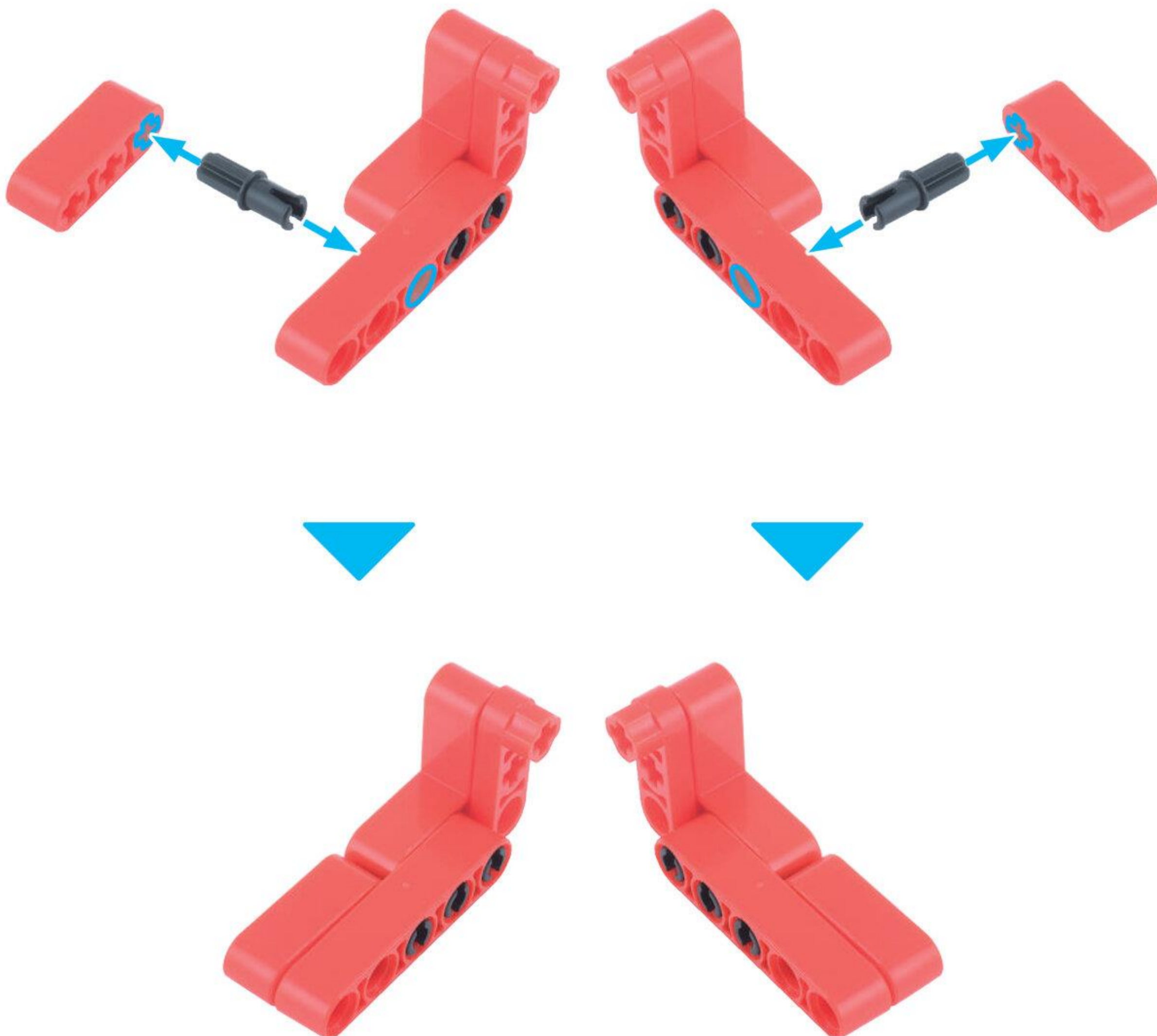

あなしゃふとじょいんと
アナシャフトジョイント 1こ



しゃふとよんぼち
シャフト 4 ポチ 2こ



ながさに
ちゅうい

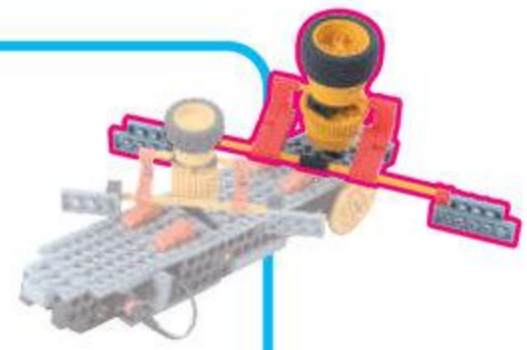

4

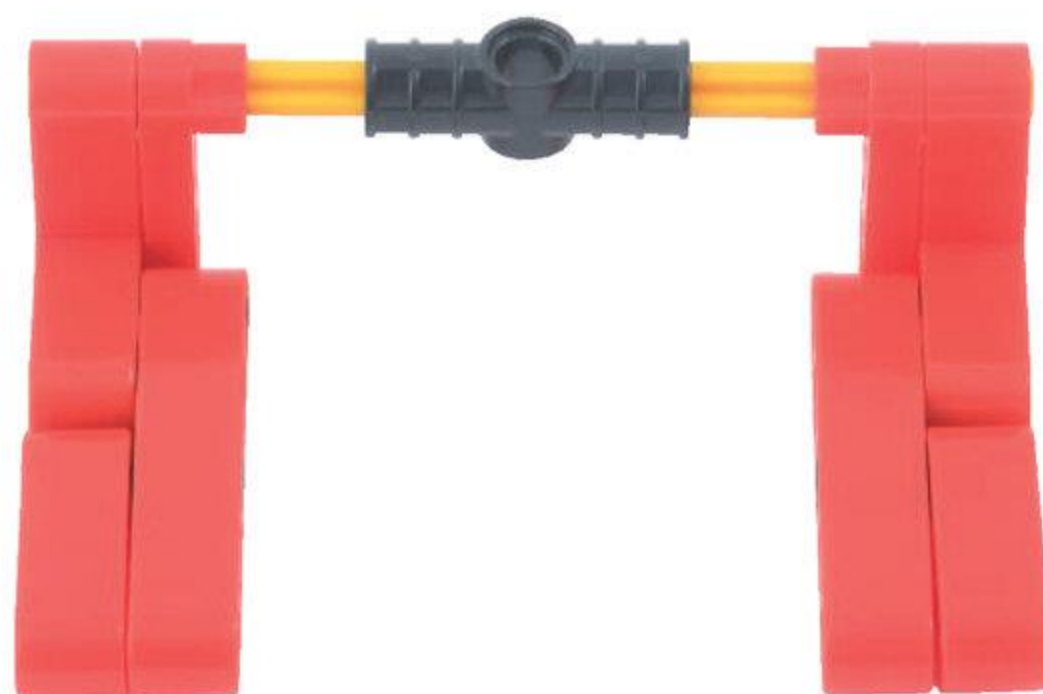

シャフトジョイント 1こ



シャフト 10ポチ 2こ

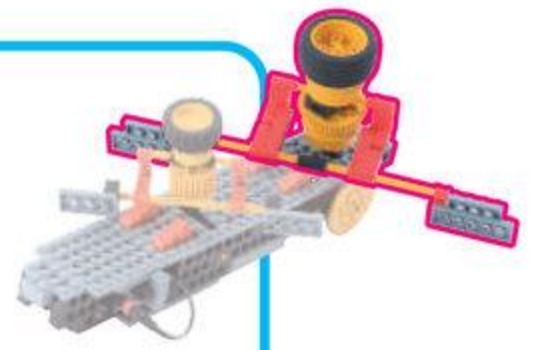

5

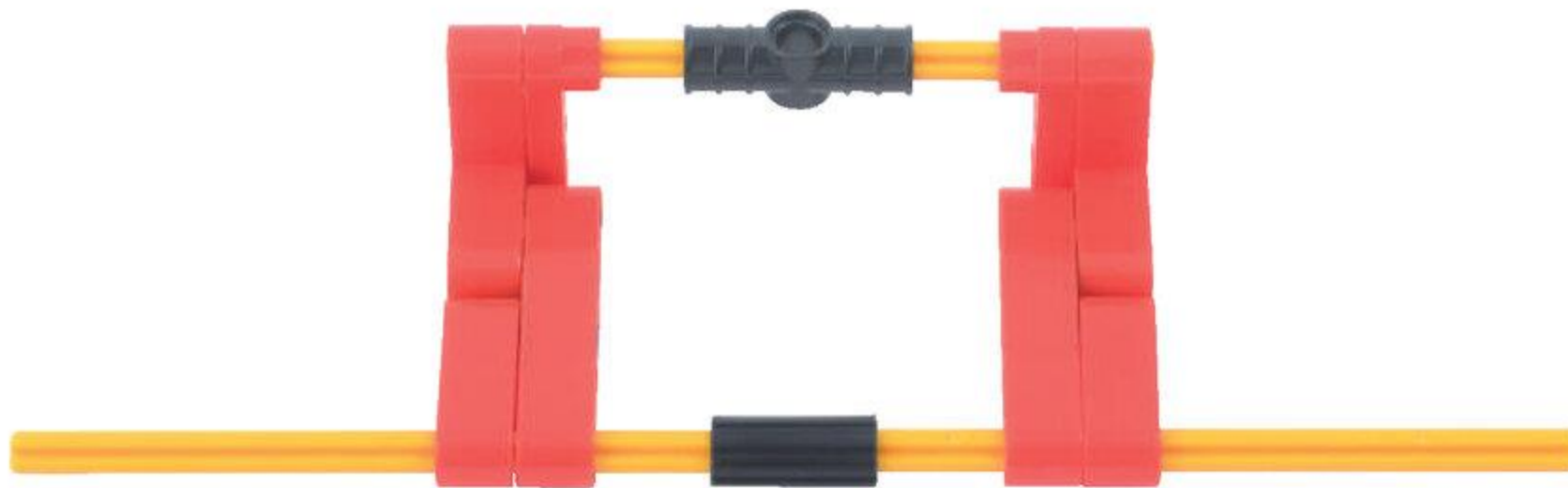
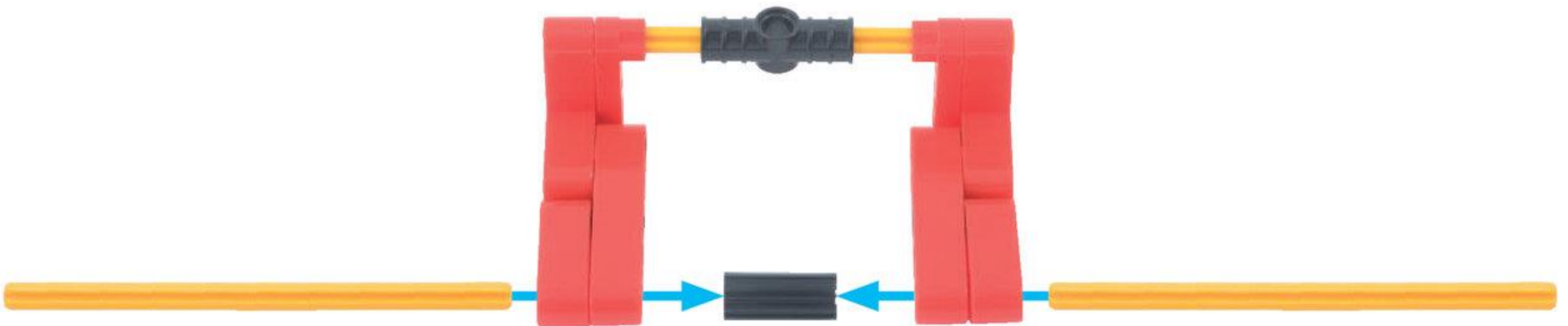

たいやえろ
タイヤ L 1こ

ぎあえろ
ギア L 1こ

ぎあえむ
ギア M うす 1こ

しゃふとじゅう ぼち
シャフト 10 ポチ 1こ

6

ごむ
ゴムを
はずす

ぼち
5 ポチぶん

ごむ
ゴムを はずすのは
せんせいに
やってもらおう

びいむにほち
ビーム2ポチ 1こ

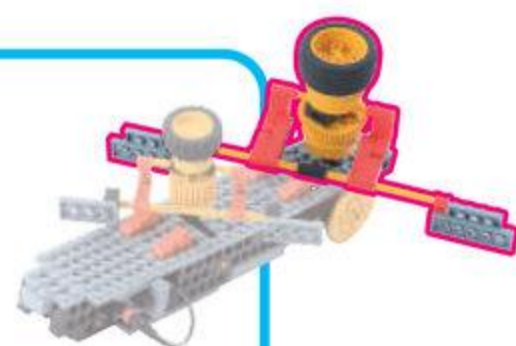

7

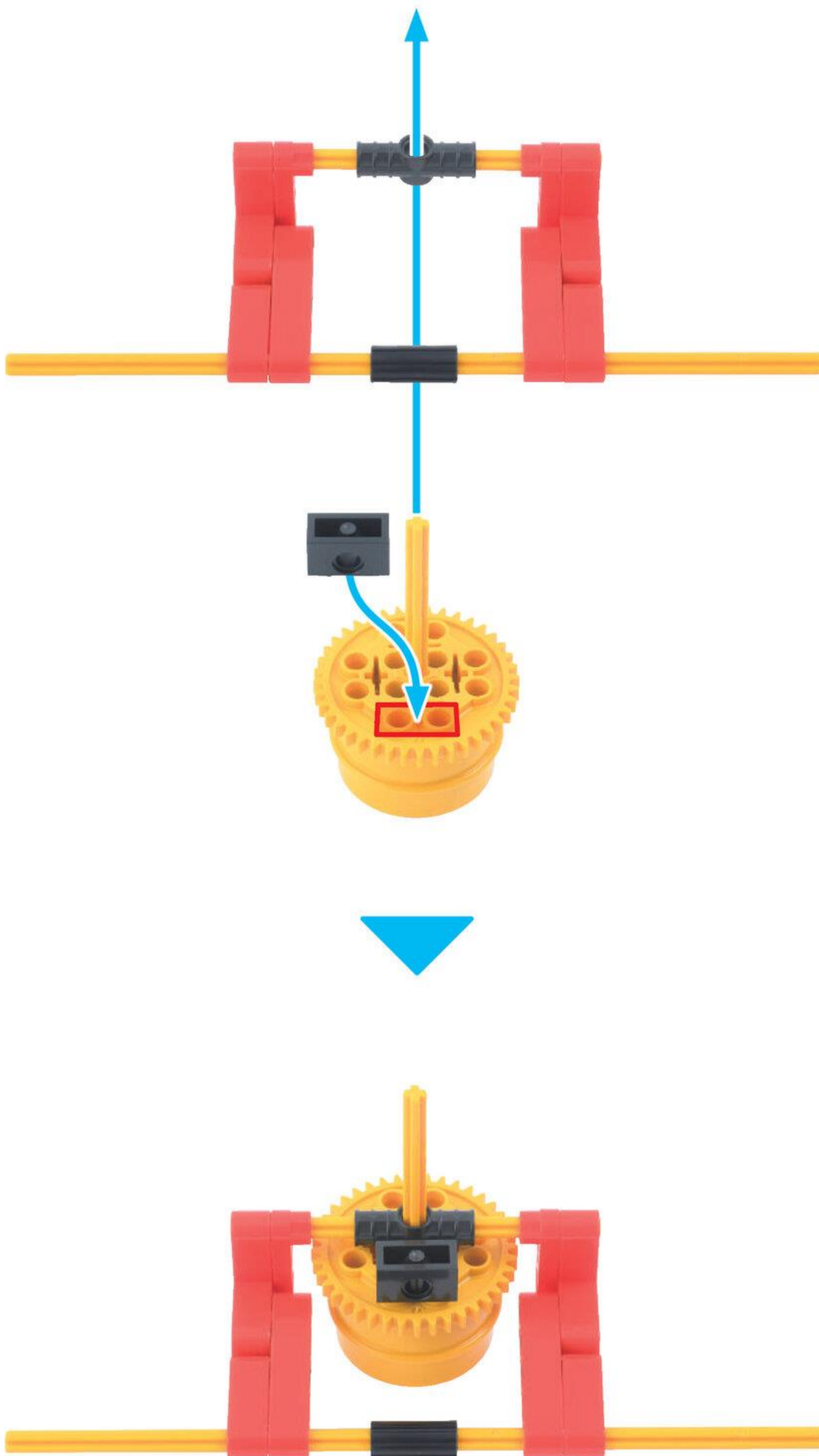

タイヤ 2こ
えり

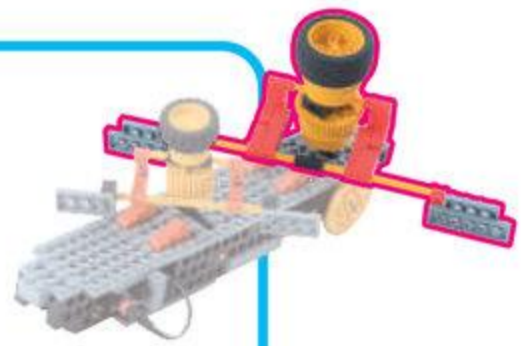

8 ゴムをはずす



タイヤは
1こだよ
ゴムをはずす

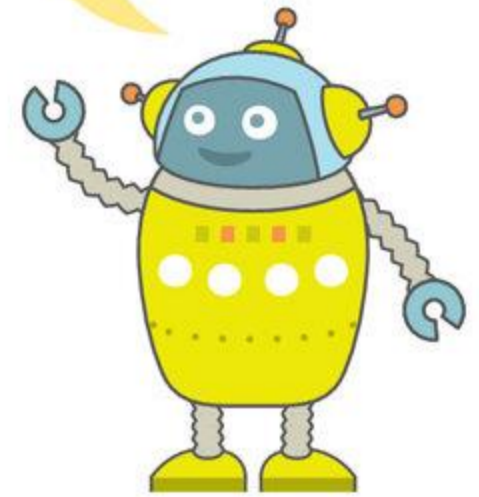

くろすじょいんと
クロスジョイント **2**こ



ふとぶれえとよんぼち
太プレート 4 ポチ **2**こ



ふとぶれえとろくぼち
太プレート 6 ポチ **2**こ

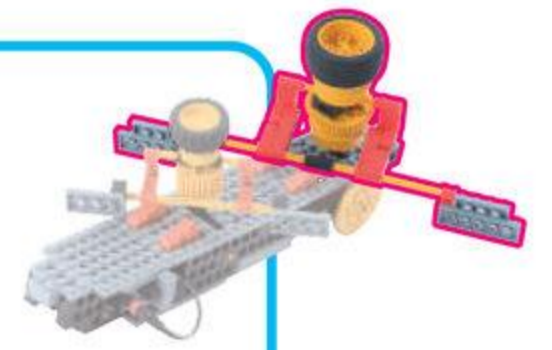

9

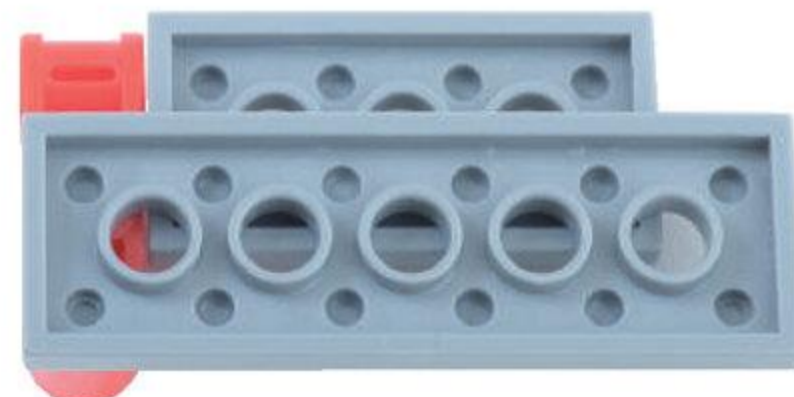
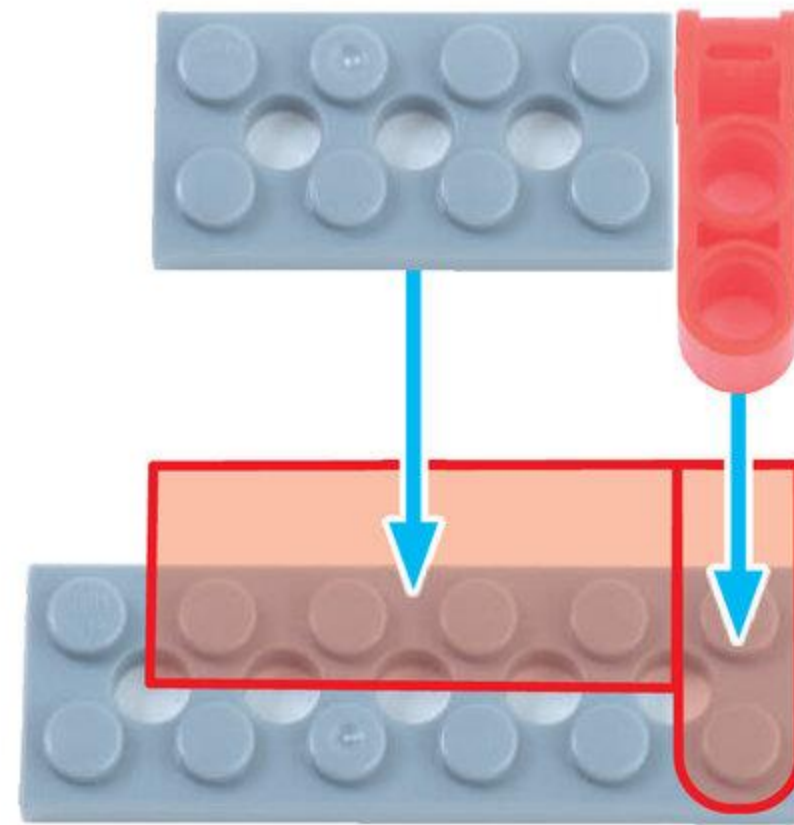
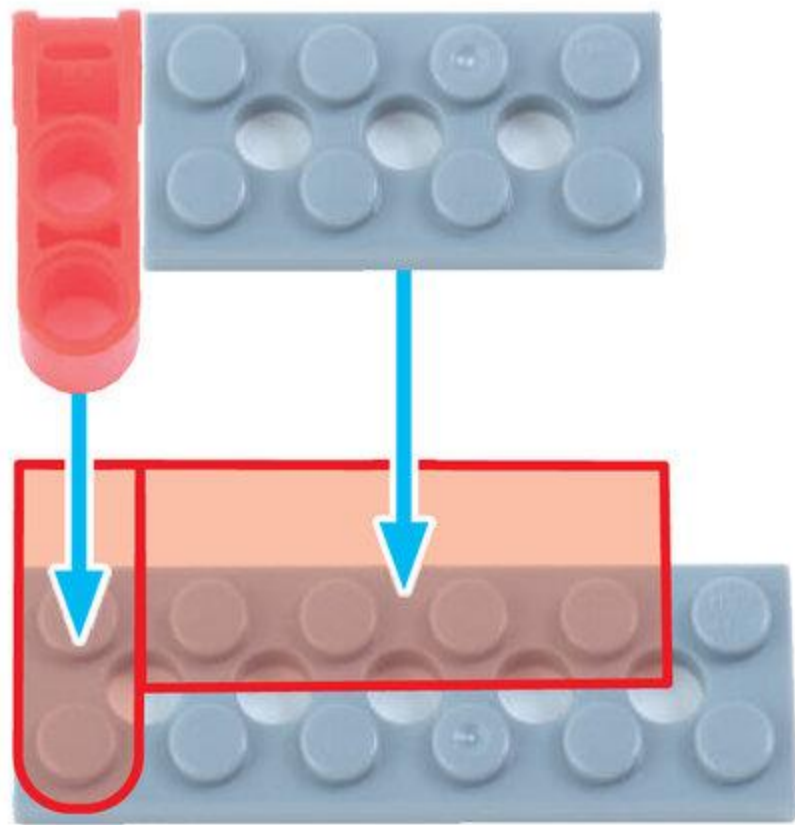

10

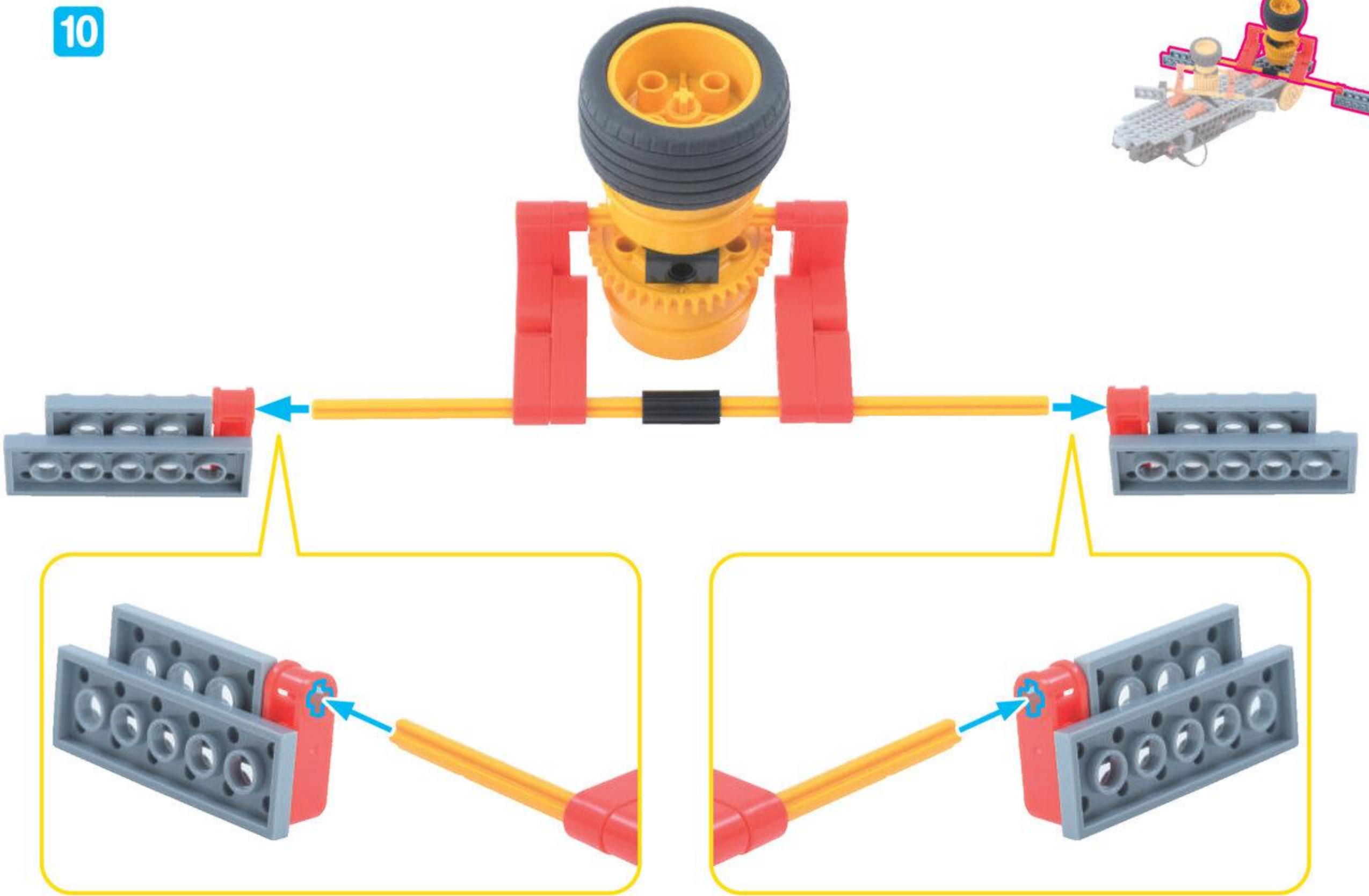
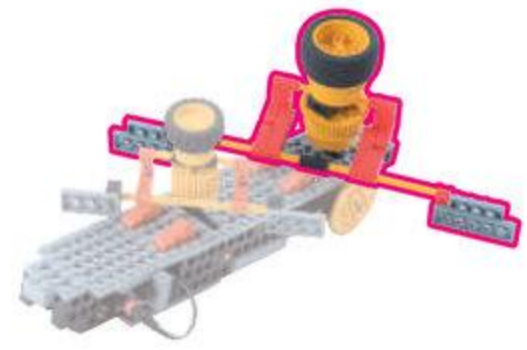

おとなが
かんせい!

やったね!

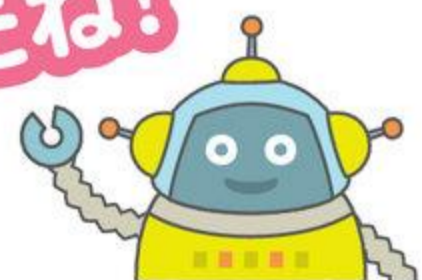

2 こども

めやす 15 ぶん

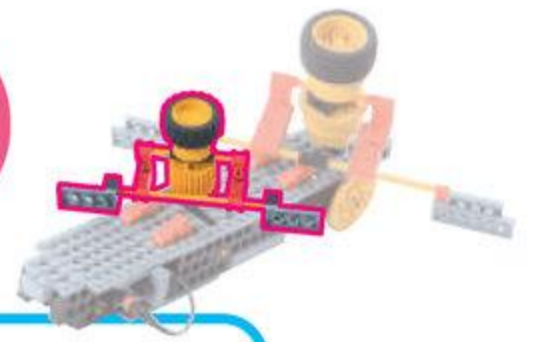

くるすじょいんと
クロスジョイント 2こ



しゃふとペグ
シャフトペグ 2こ



ていじょいんと
T ジョイント 2こ



1

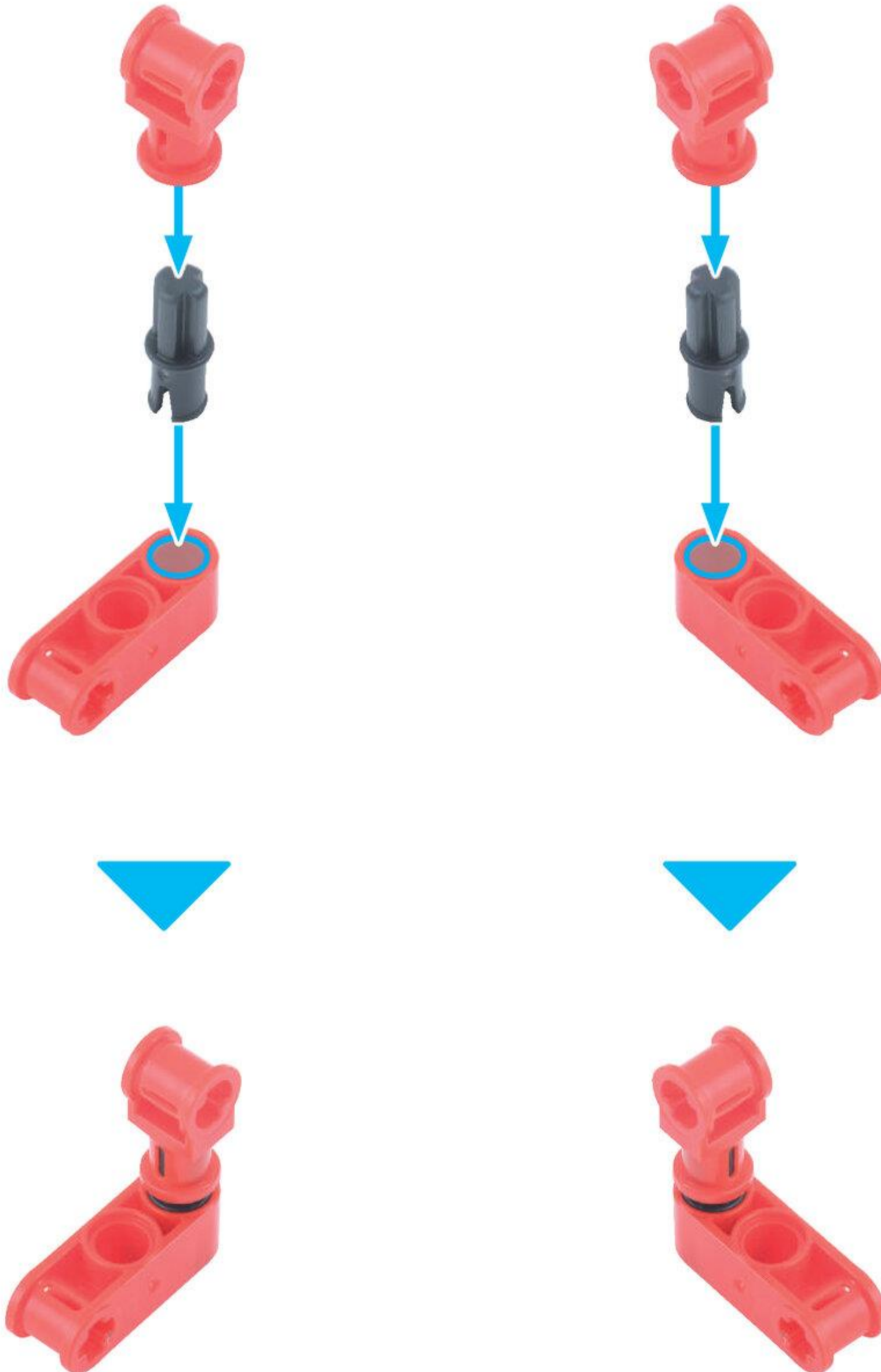

あなしゃふとじょいんと
アナシャフトジョイント 1こ



しゃふとさんぽち
シャフト 3 ポチ 2こ



ながさに
ちゅうい



2



あな
アナの むきに
ちゅういしよう

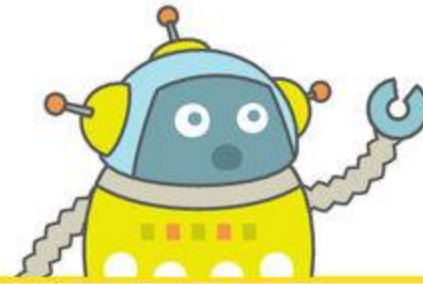

しゃふとじゅうにぼち
シャフト 12 ポチ 1こ

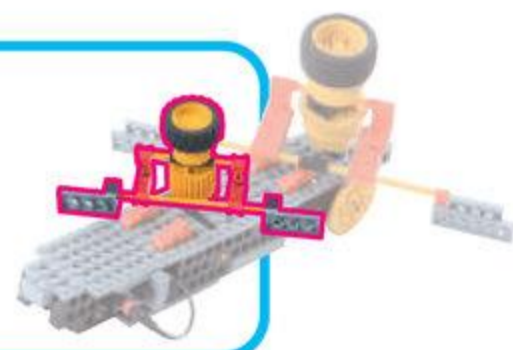

3

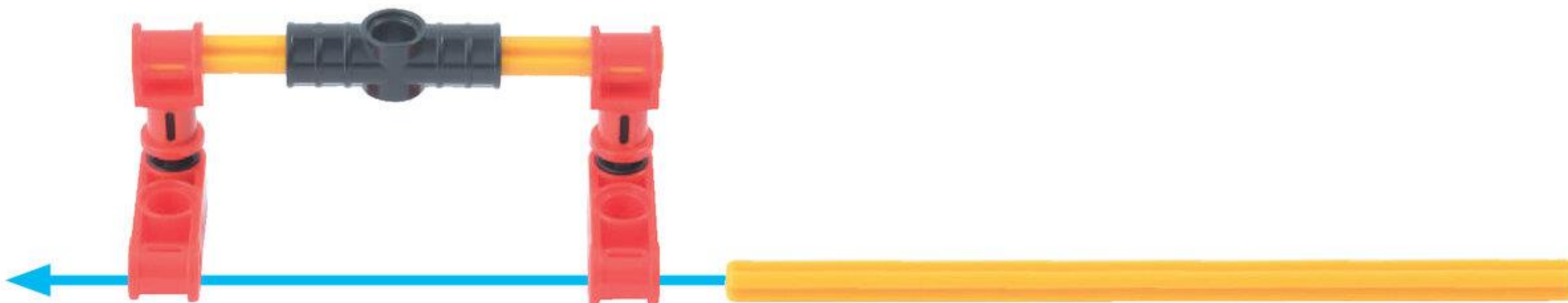

しゃふと ^{はち} ぽち
シャフト 8 ポチ 1こ



ぎあ ^{えむ}
ギア M うす 5こ

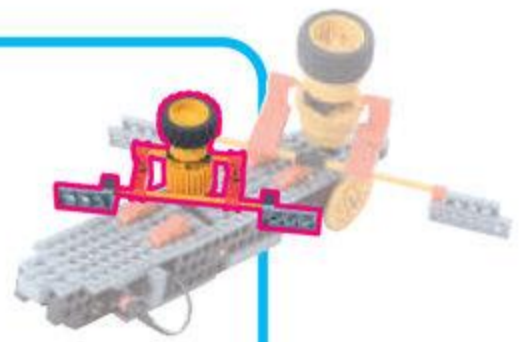
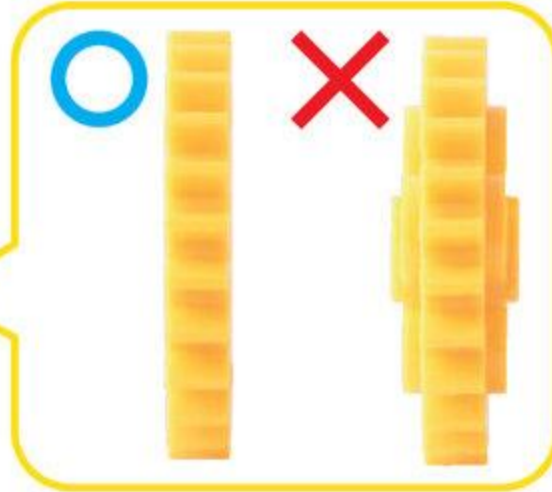
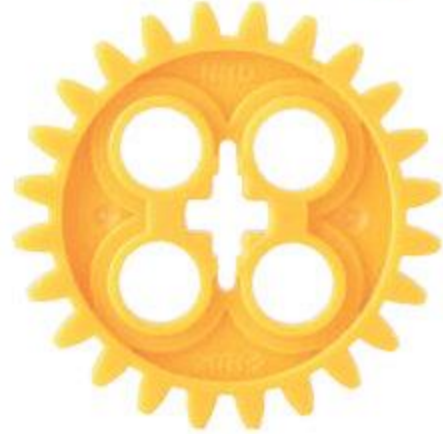

4

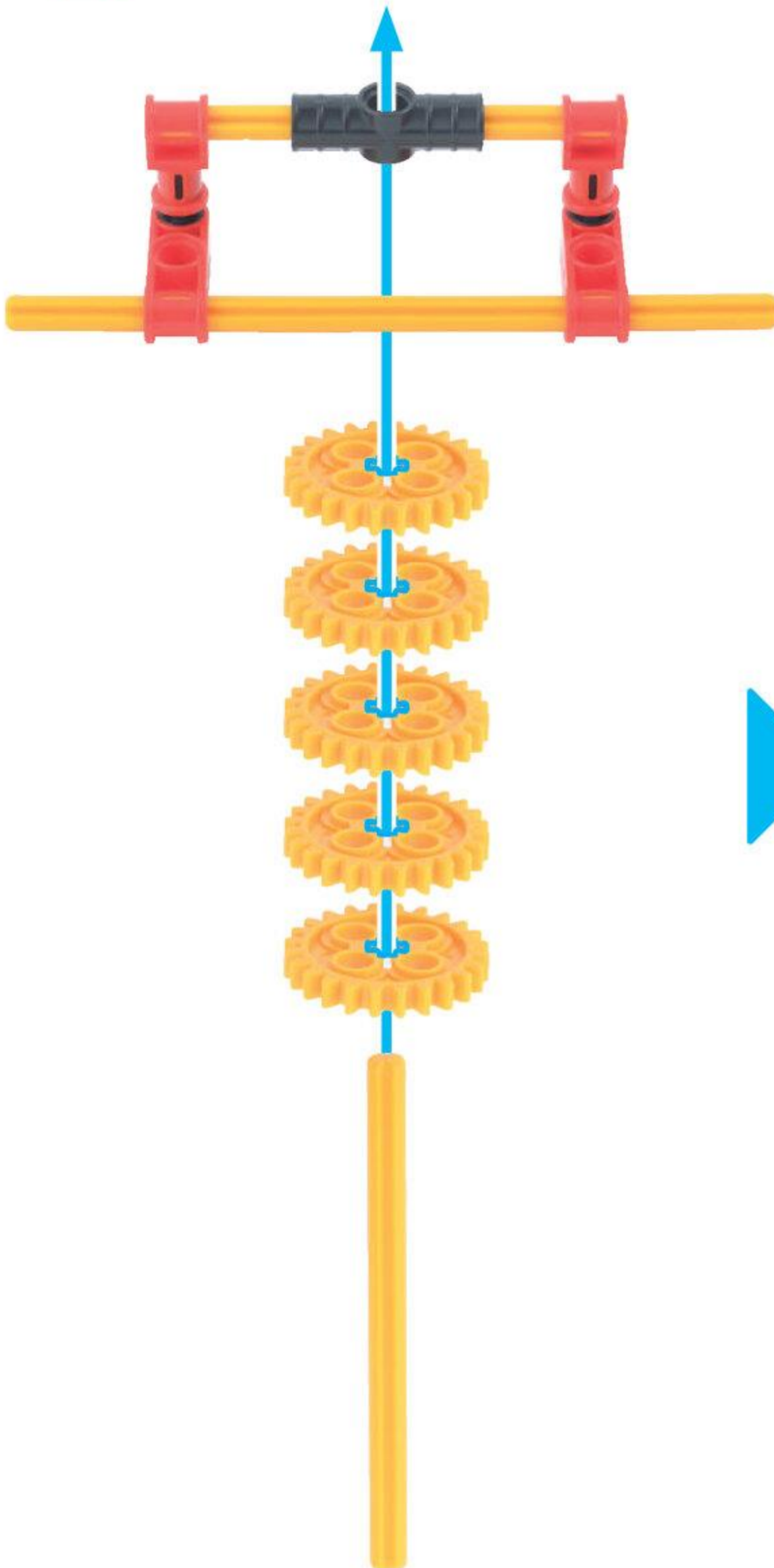

タイヤ 2こ
えす S

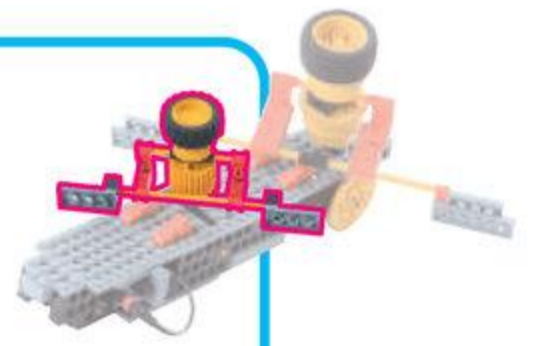

5 ゴムをはずす



タイヤは
1こだよ
ゴムをはずす

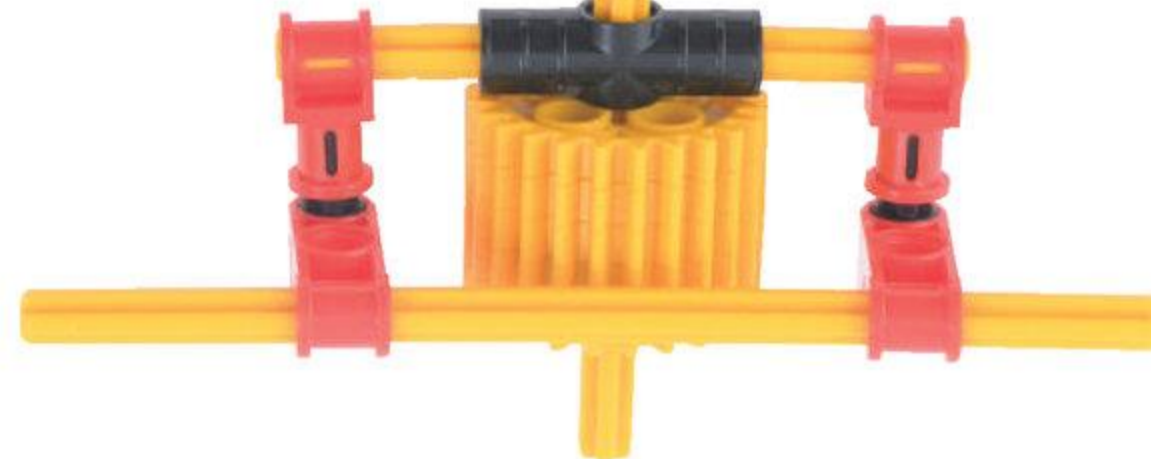
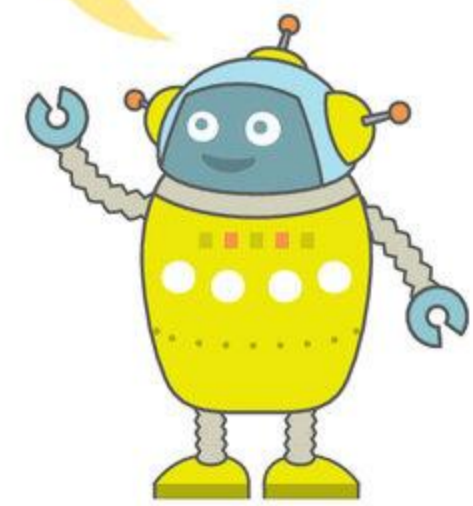

しゃふとびいむにほち
シャフトビーム 2 ポチ 2 こ

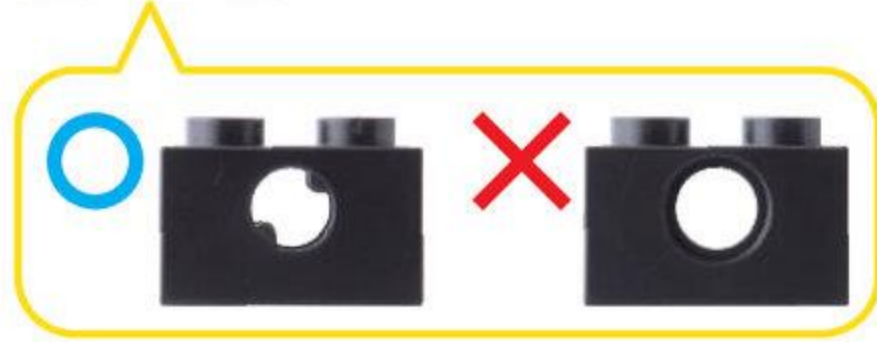

ふとぶれえとよんほち
太プレート 4 ポチ 2 こ

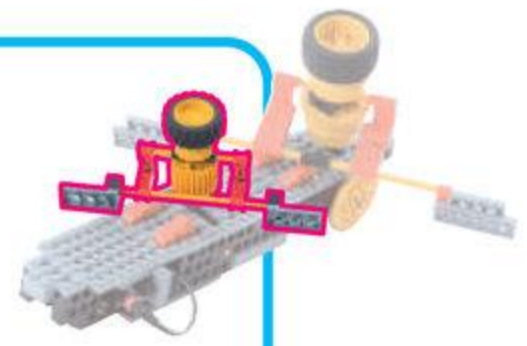

6

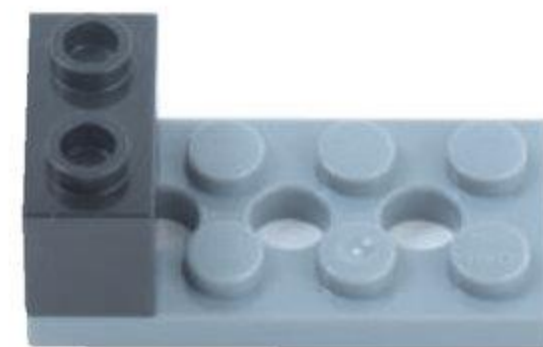
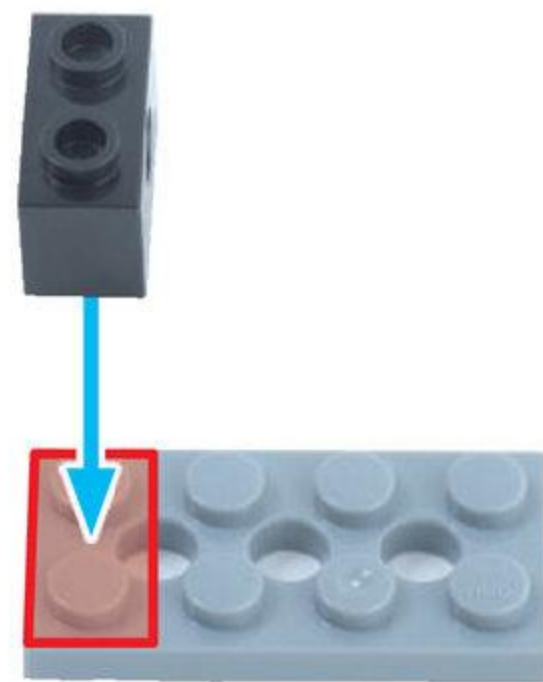
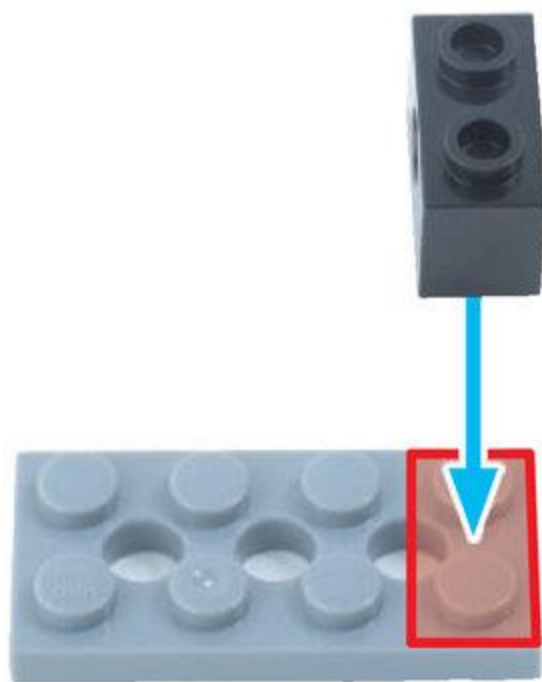

7

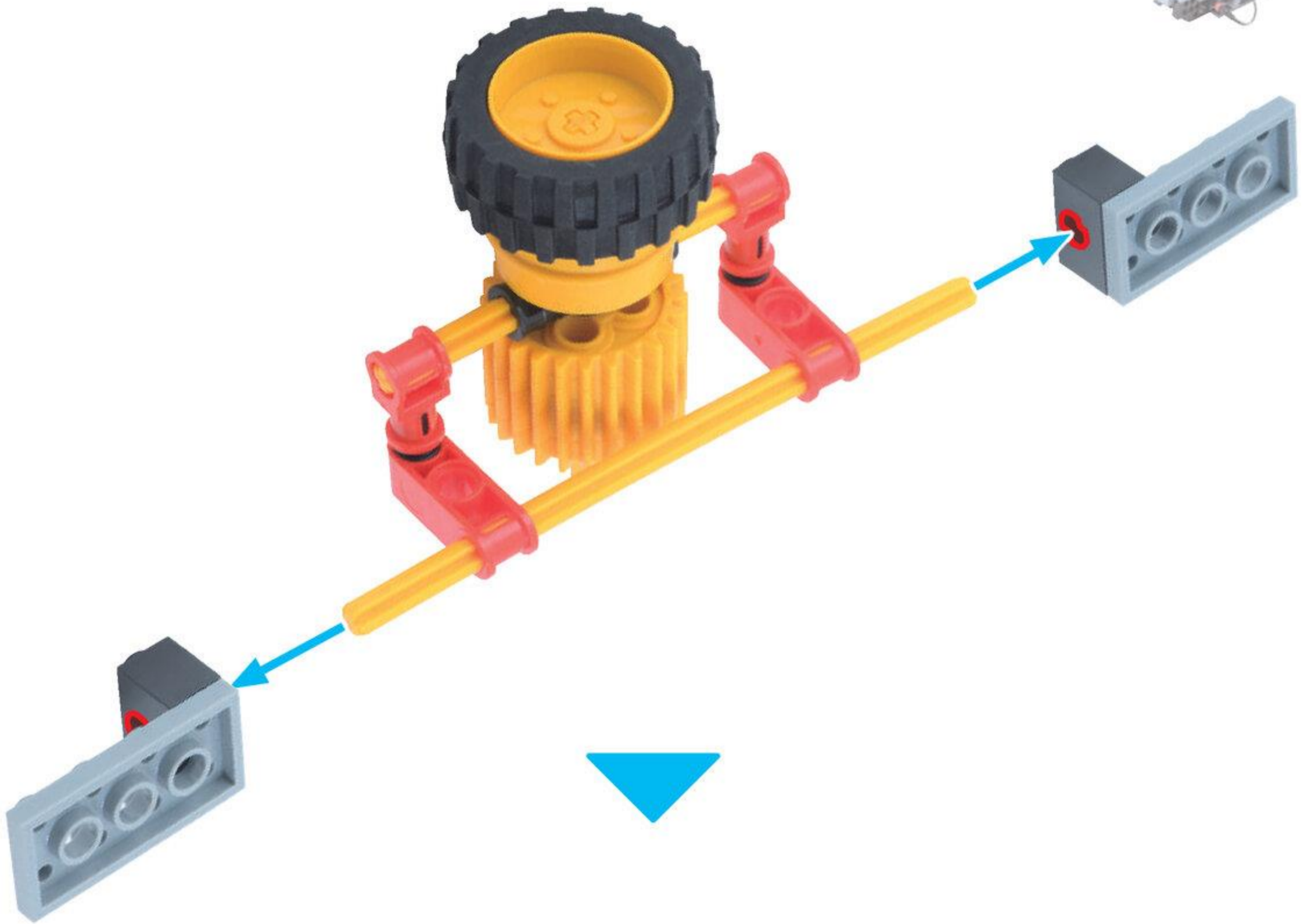

こどもが
かんせい!

やったね!

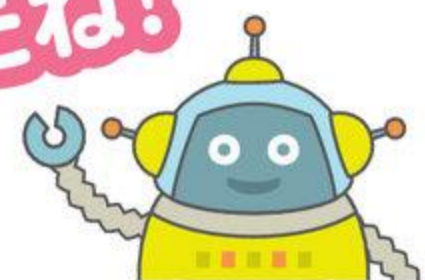

3

おとなとこどものとりつけ めやす 5 ふん



1

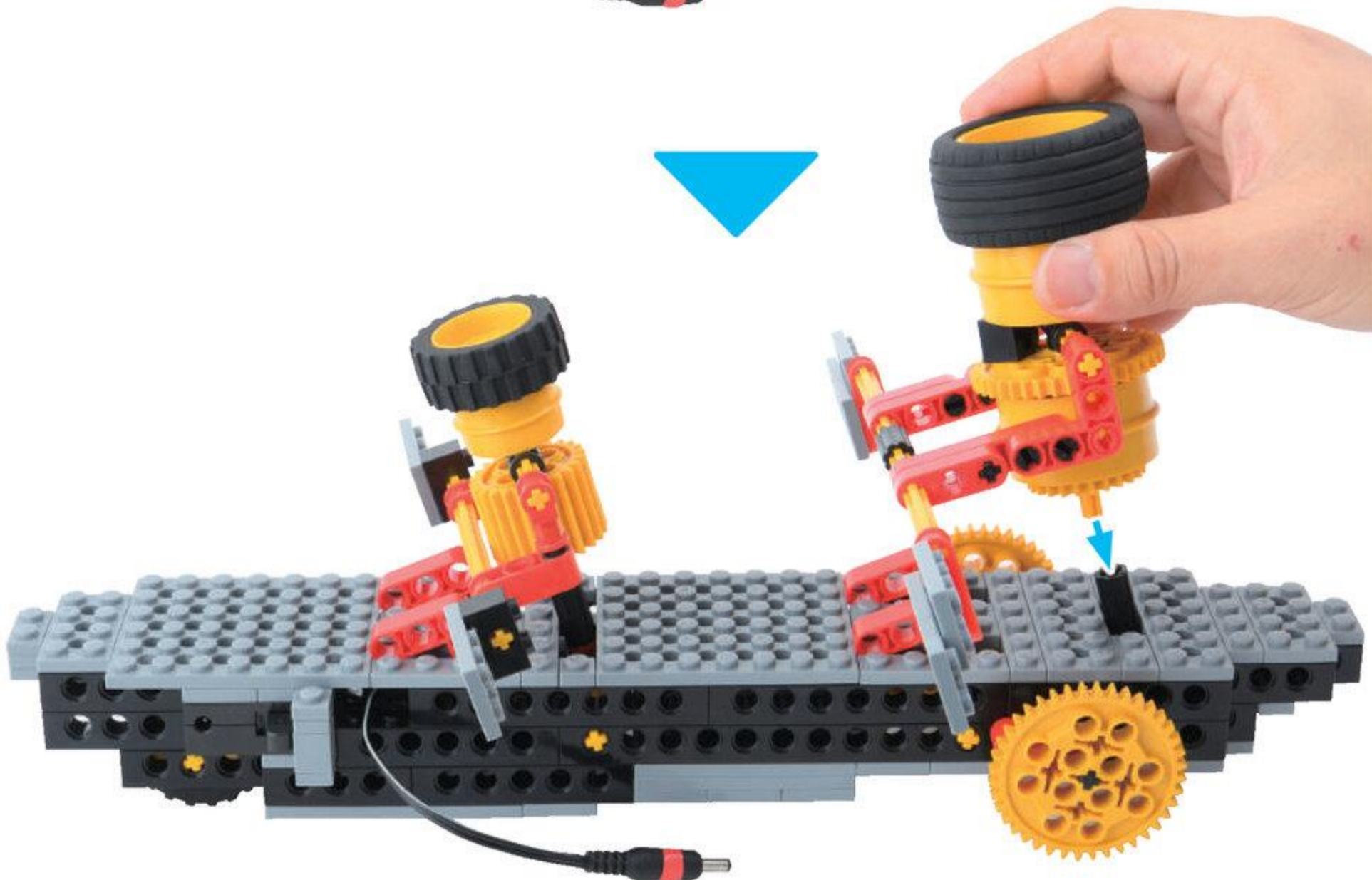
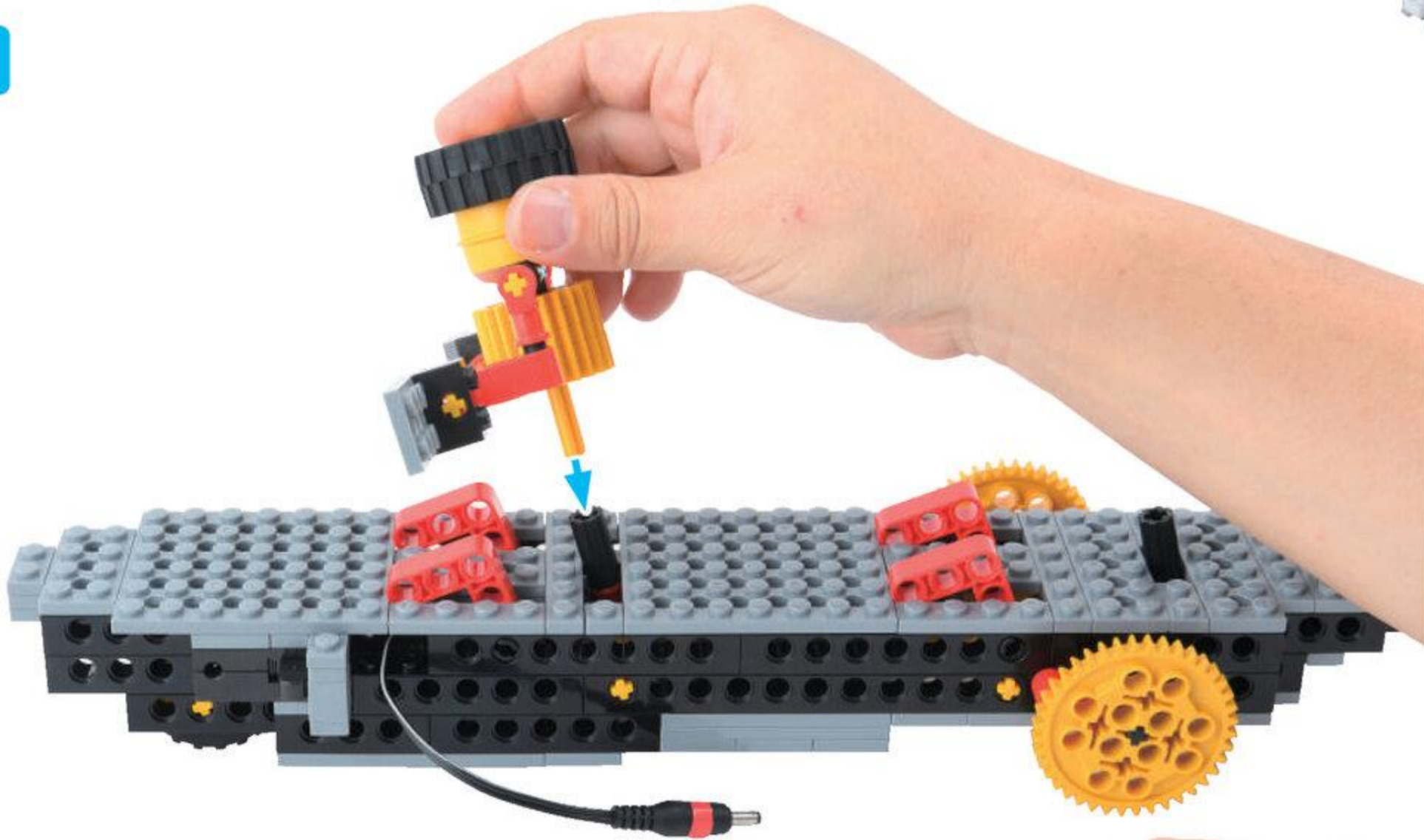

これで
かんせい!

よくできました!

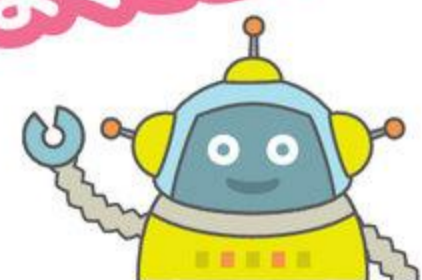

ろ ぼ っ と ロボットを うごかそう

めやす 20 ぷん



ぶらぐ プラグを さしこんだら
やじるしの むきに すいっち スイッチを いれよう

おおる
オールを こいで
すすんだかな

いぬをつくろう

めやす 15 ぶん

びいむよんぼち
ビーム 4 ポチ 2 こ



ぺぐす
ペグ S 1 こ



びにおんぎあ
ピニオンギアうす 2 こ



しゃふとよんぼち
シャフト 4 ポチ 1 こ



ながさに
ちゅうい

1

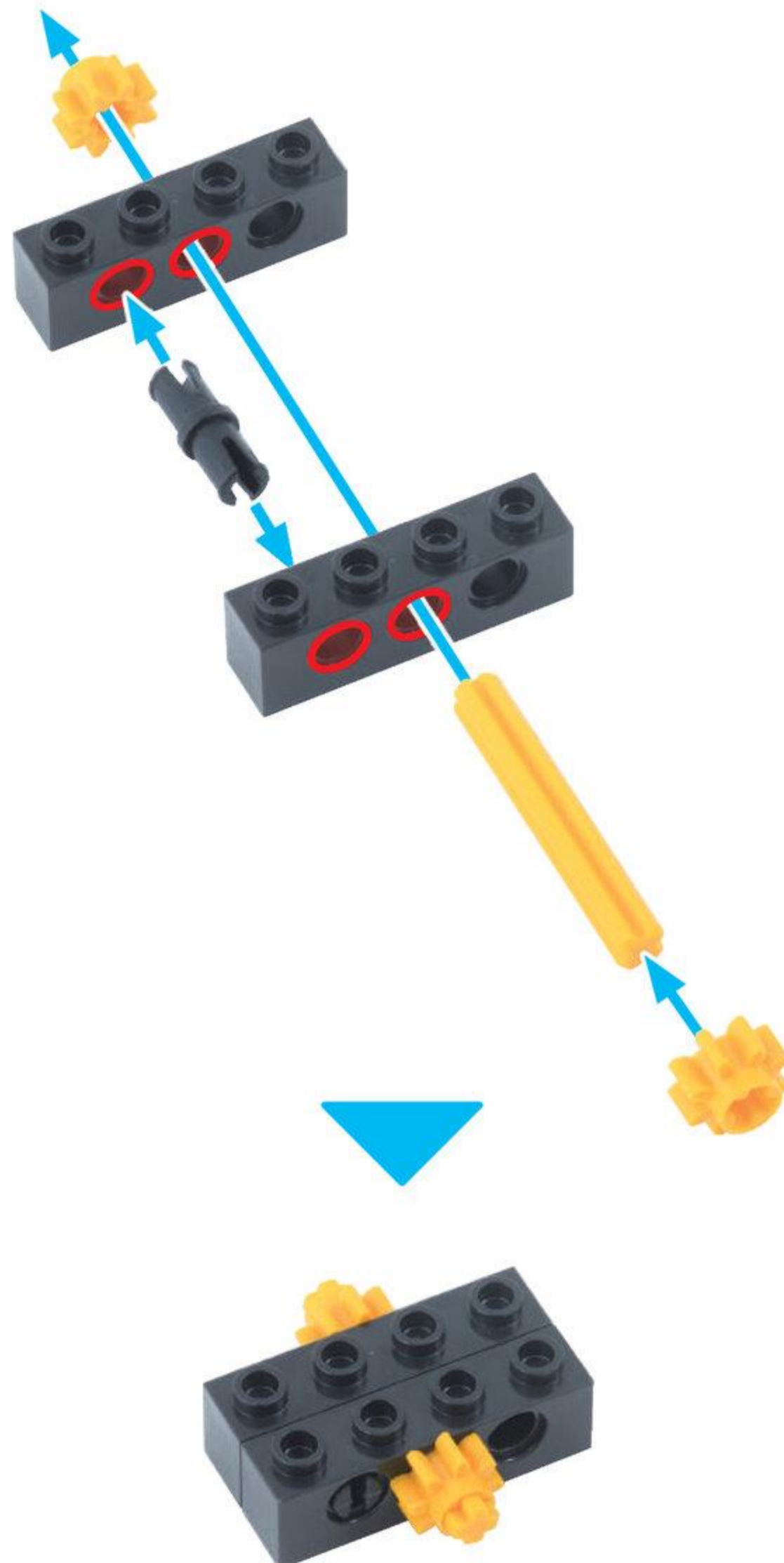

びいむにほち
ビーム2ポチ 1こ



ほそぶれえとよんほち
細プレート4ポチ 2こ



びいむいちほち
ビーム1ポチ 2こ



2

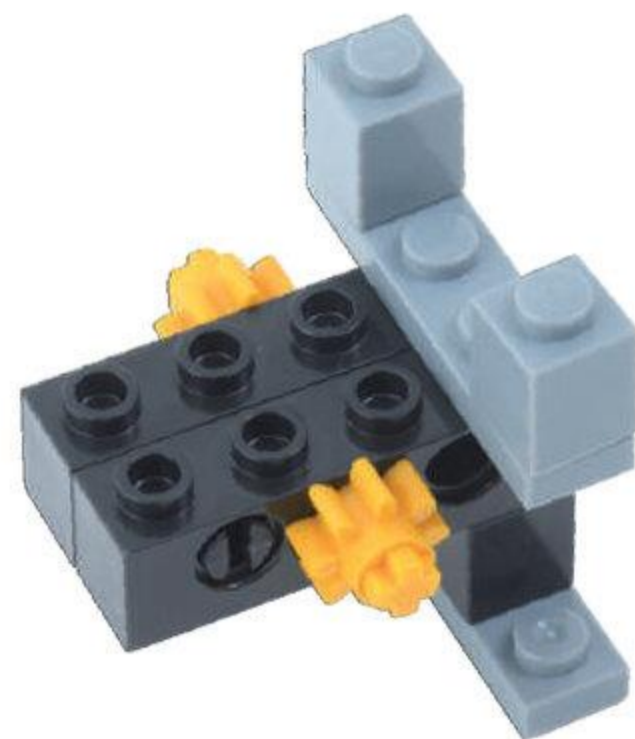
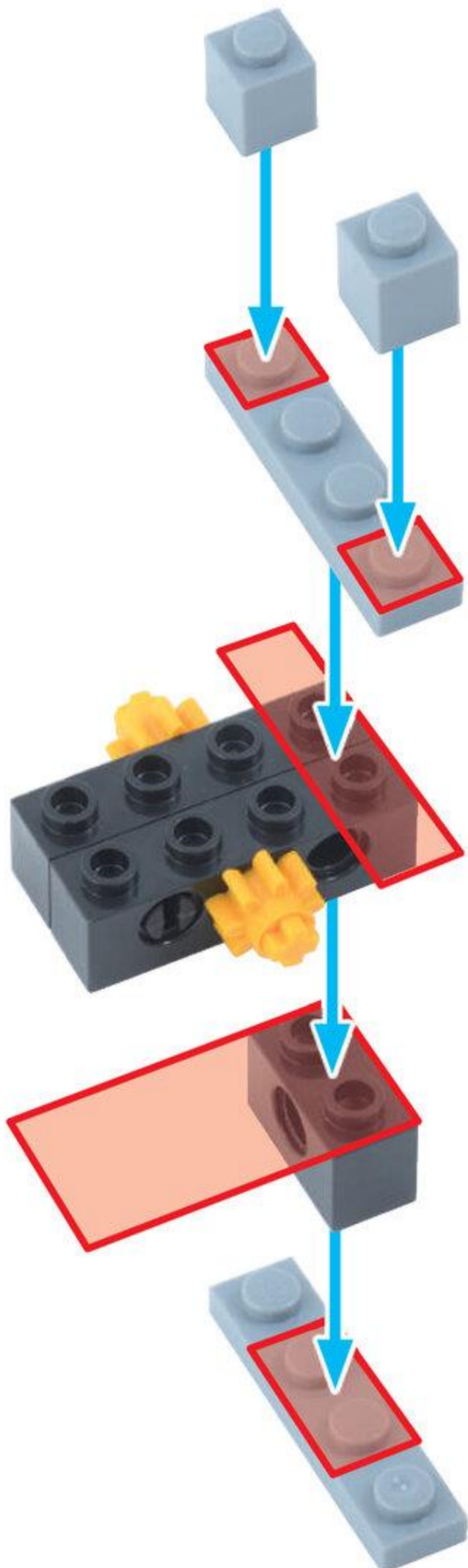

ろっど 3 あな 1 こ
ロッド3アナ 1こ



しゃふと 3 さん ぽち 2 こ
シャフト3ポチ 2こ



ながさに
ちゅうい

てい じょいんと
T ジョイント 2こ



くろ しゃふと 1.5 ぽち 2 こ
黒シャフト 1.5ポチ 2こ



3

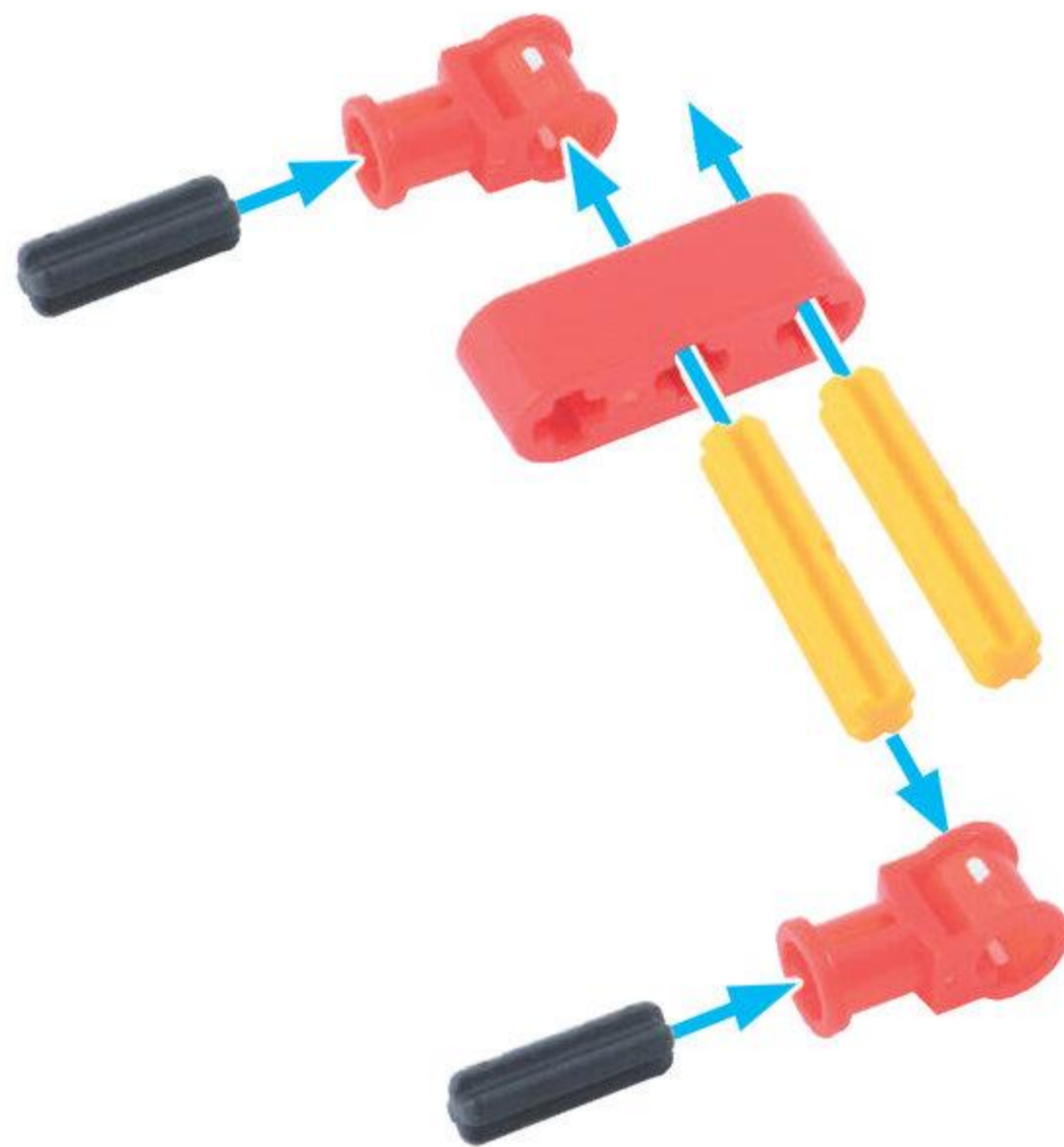

ろっど あな 5 アナ 1 こ



peg 3 こ



4



くろすじょいんと
クロスジョイント 2こ



ろっど 5 アナ 1こ



5

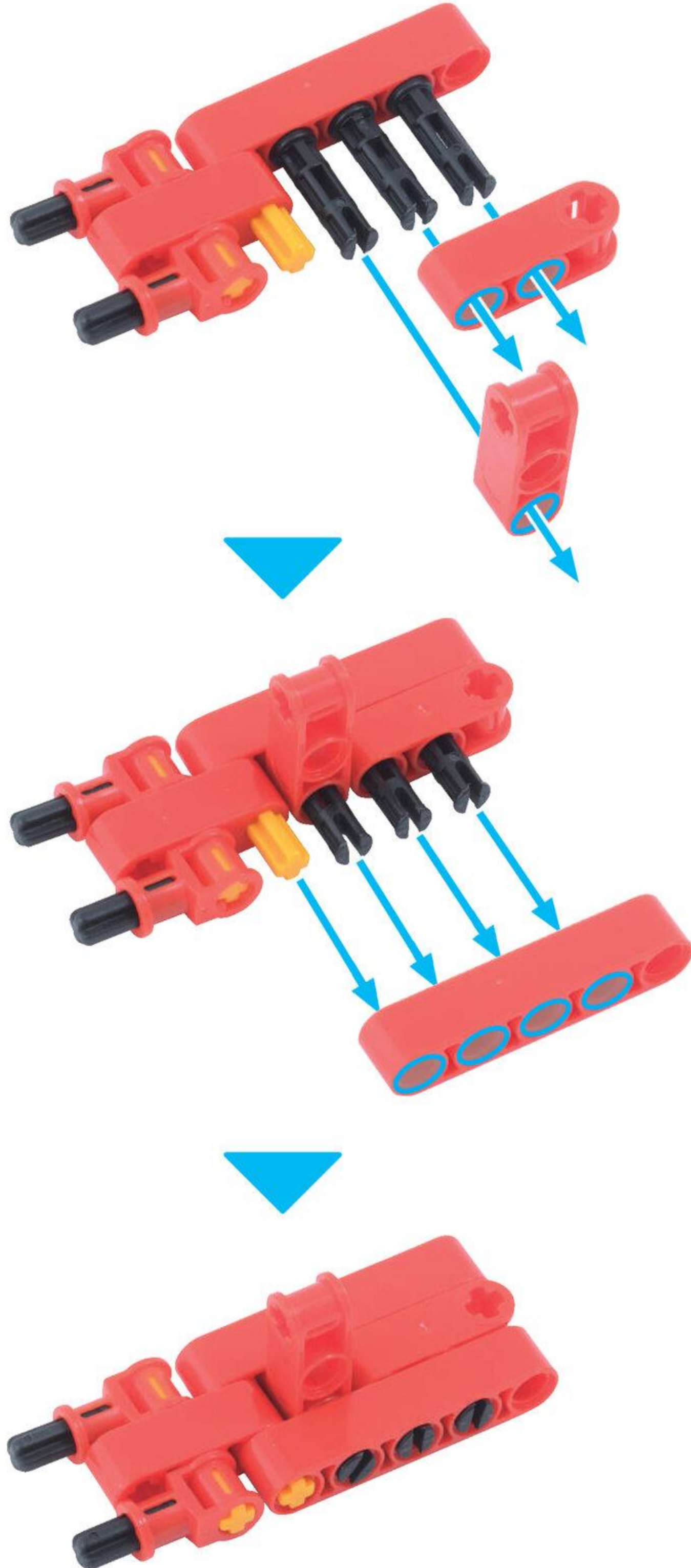

くらんく 2こ



6

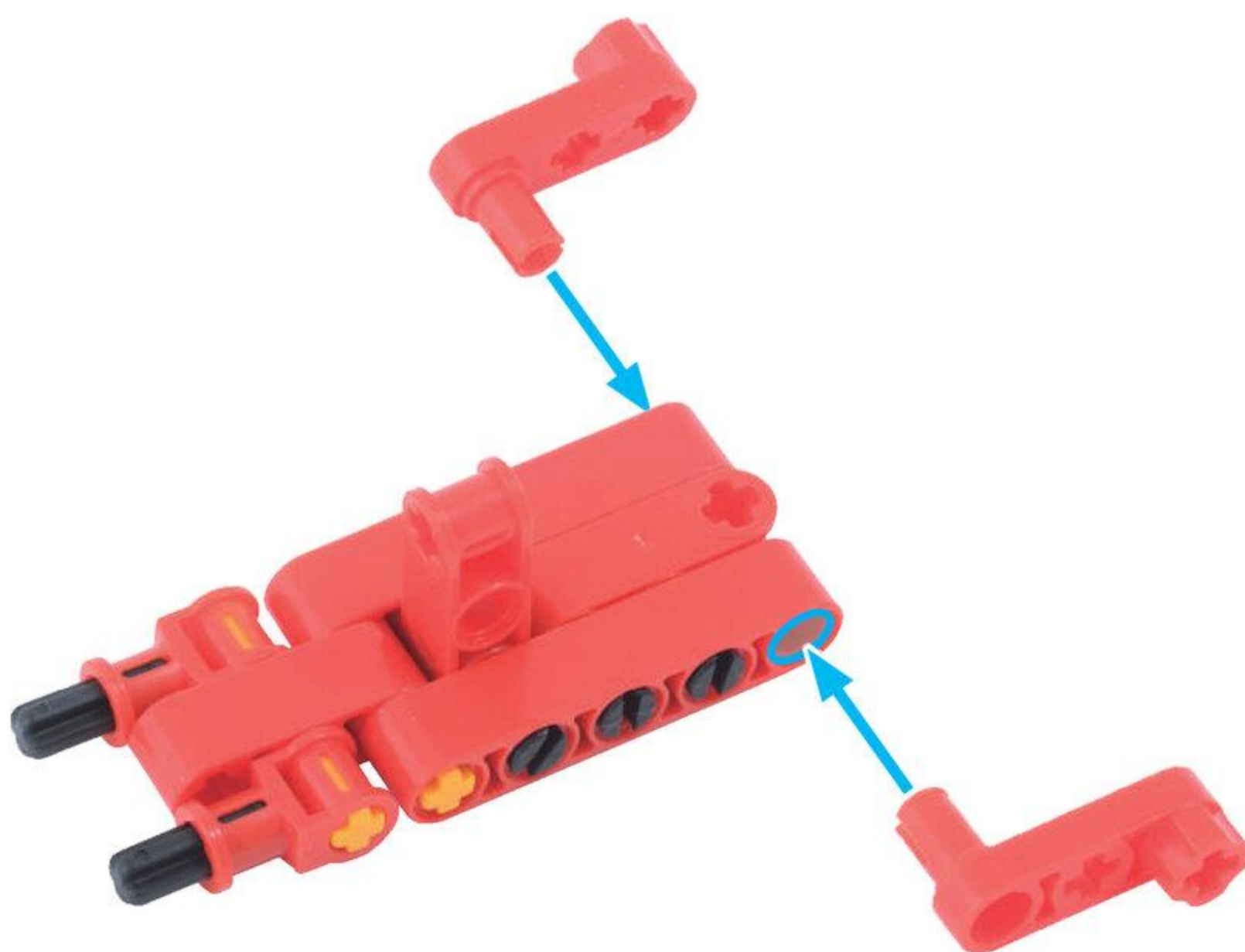

しゃふとペグ
シャフトペグ 1こ

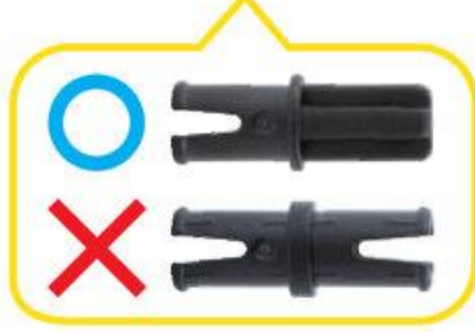

くろしゃふとにほち
黒シャフト2ポチ 1こ



7

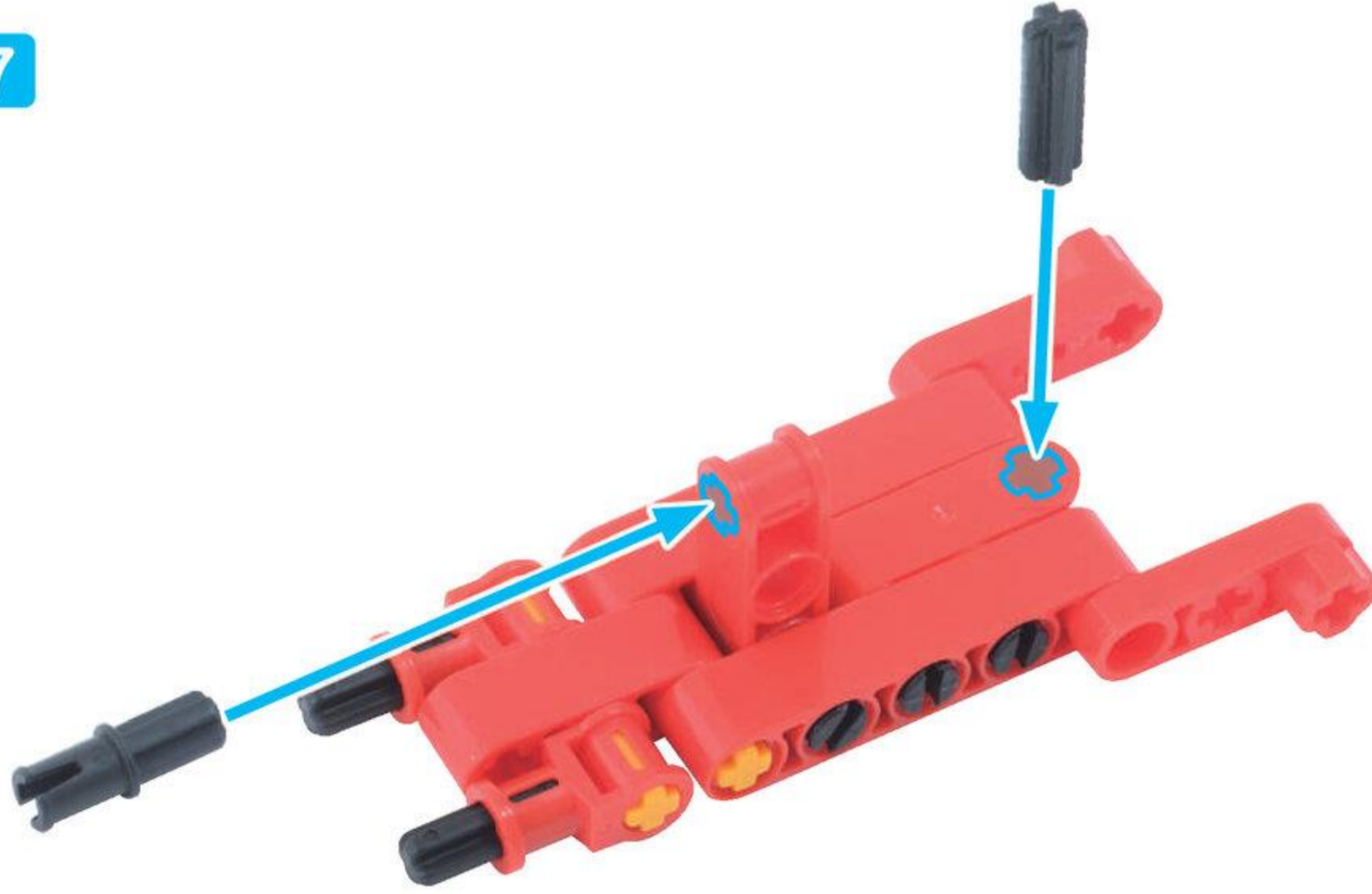

8

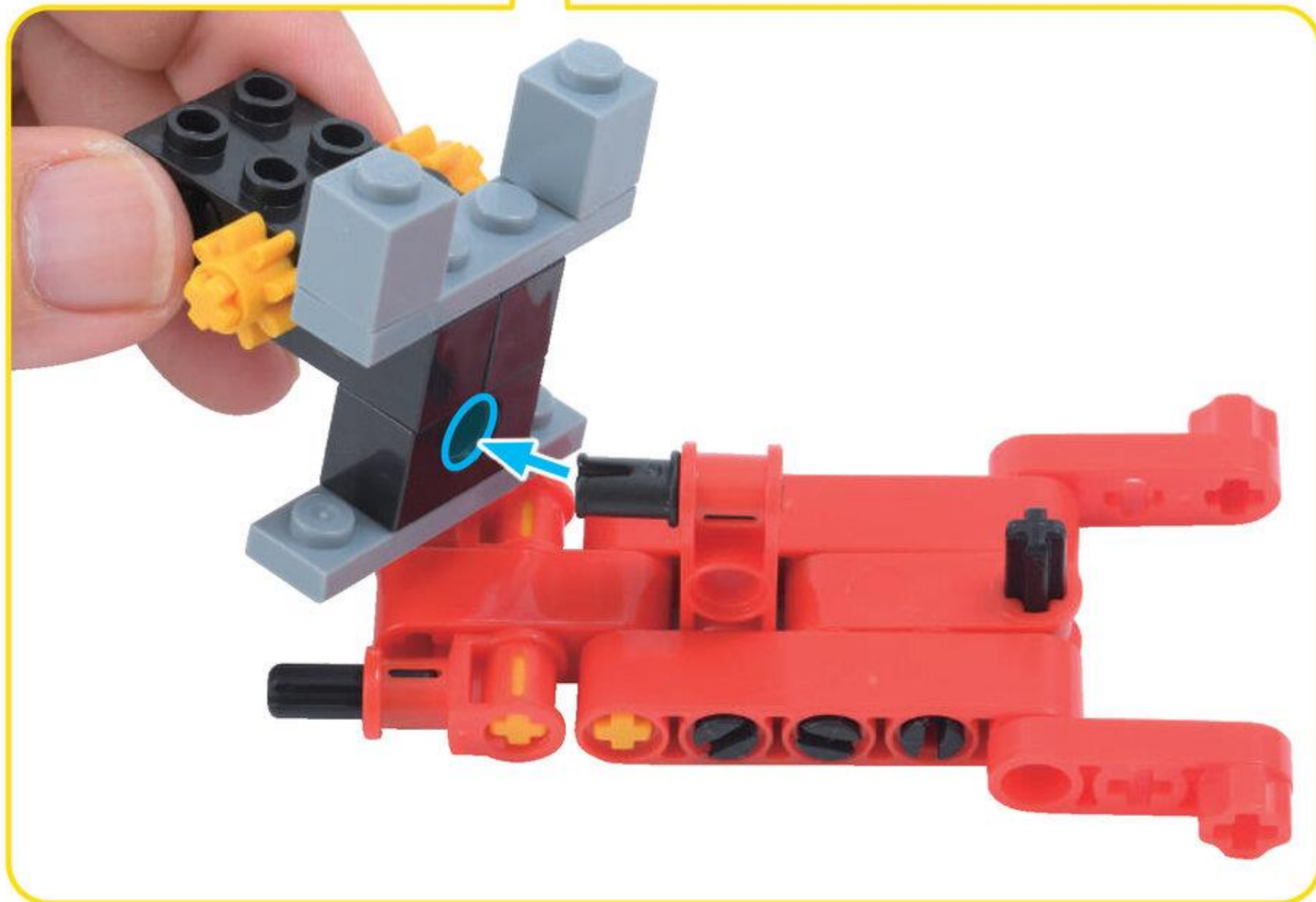
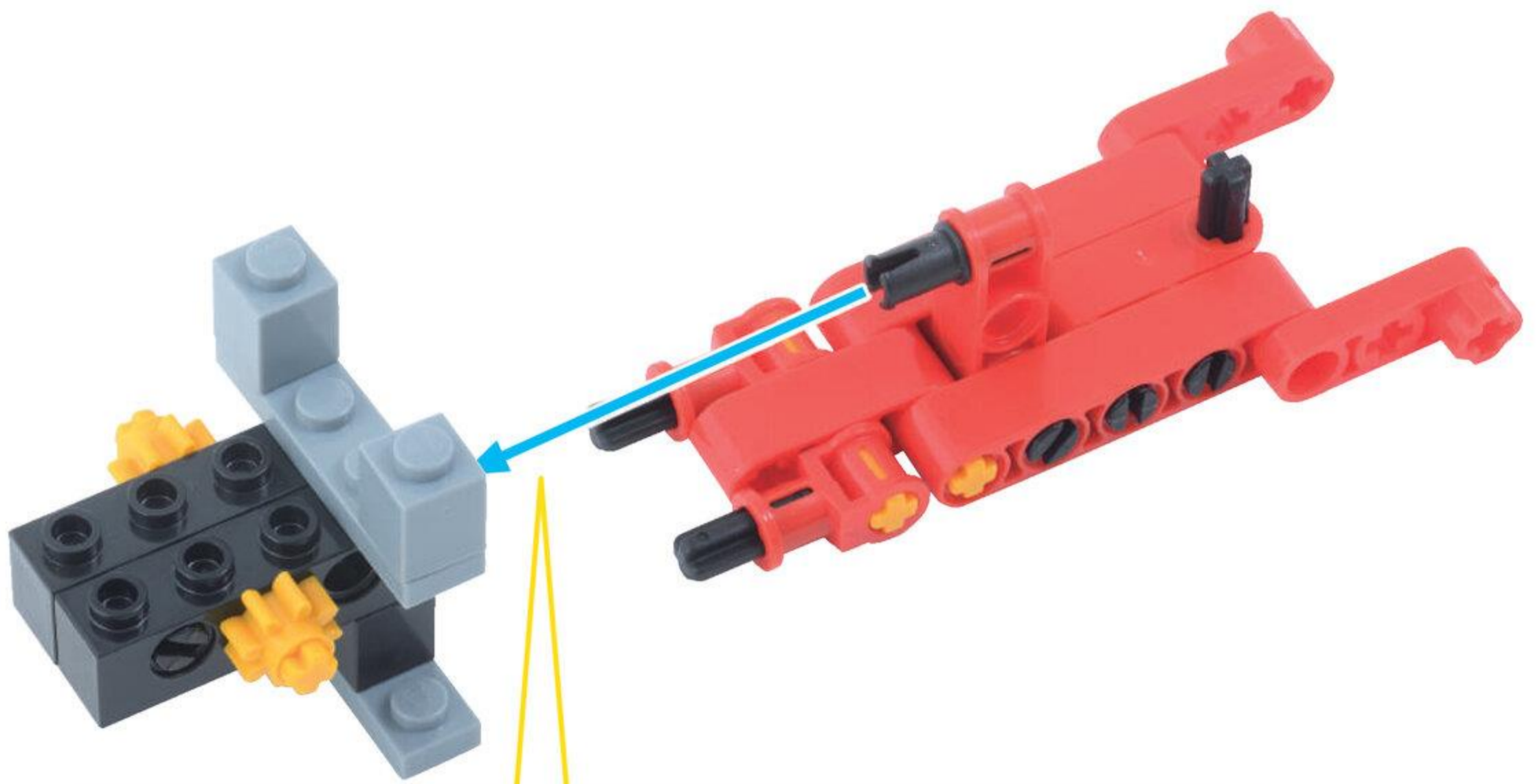

じゅうにかいぞうしてみよう

めやす 10 ぶん

いぬといっしょにあそぼう

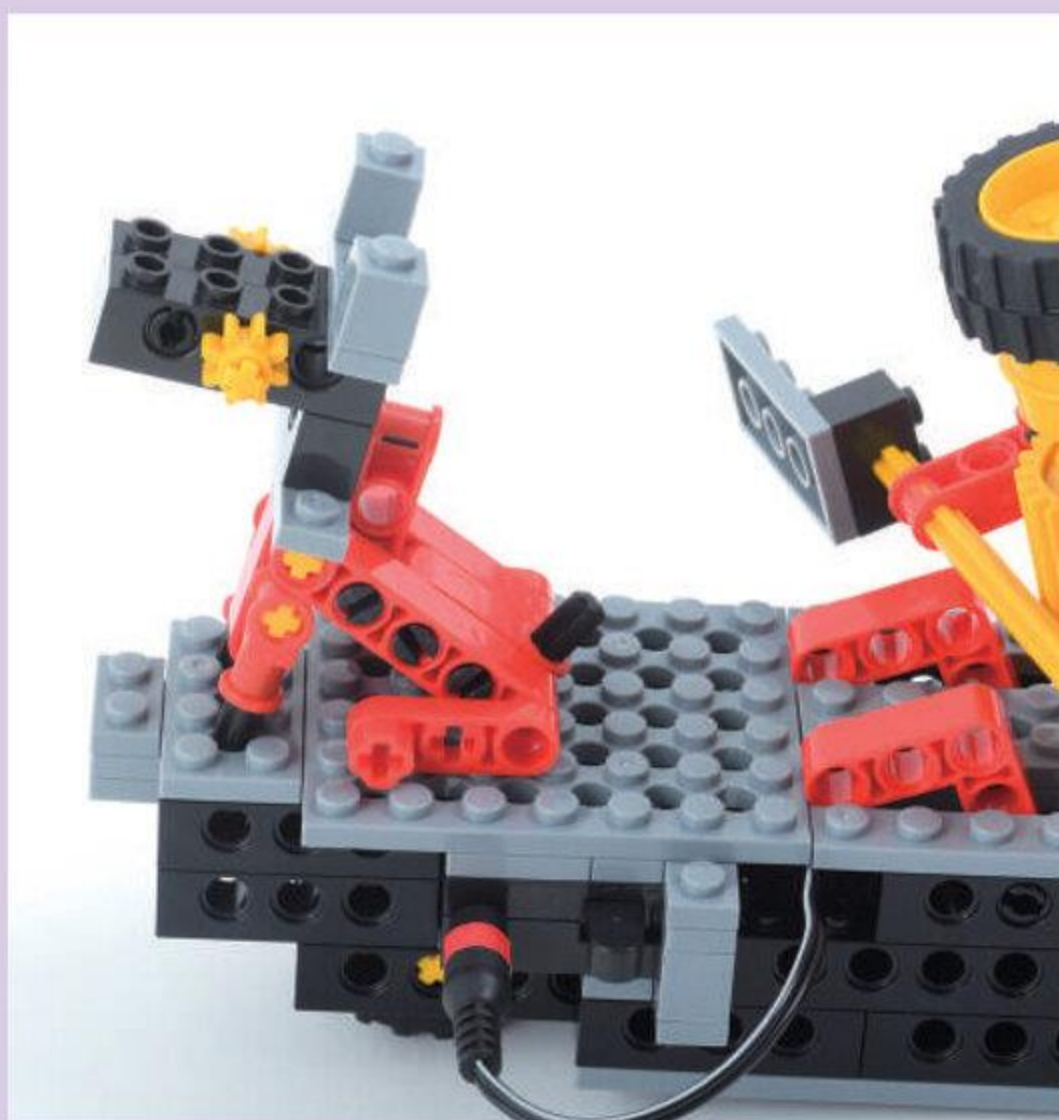
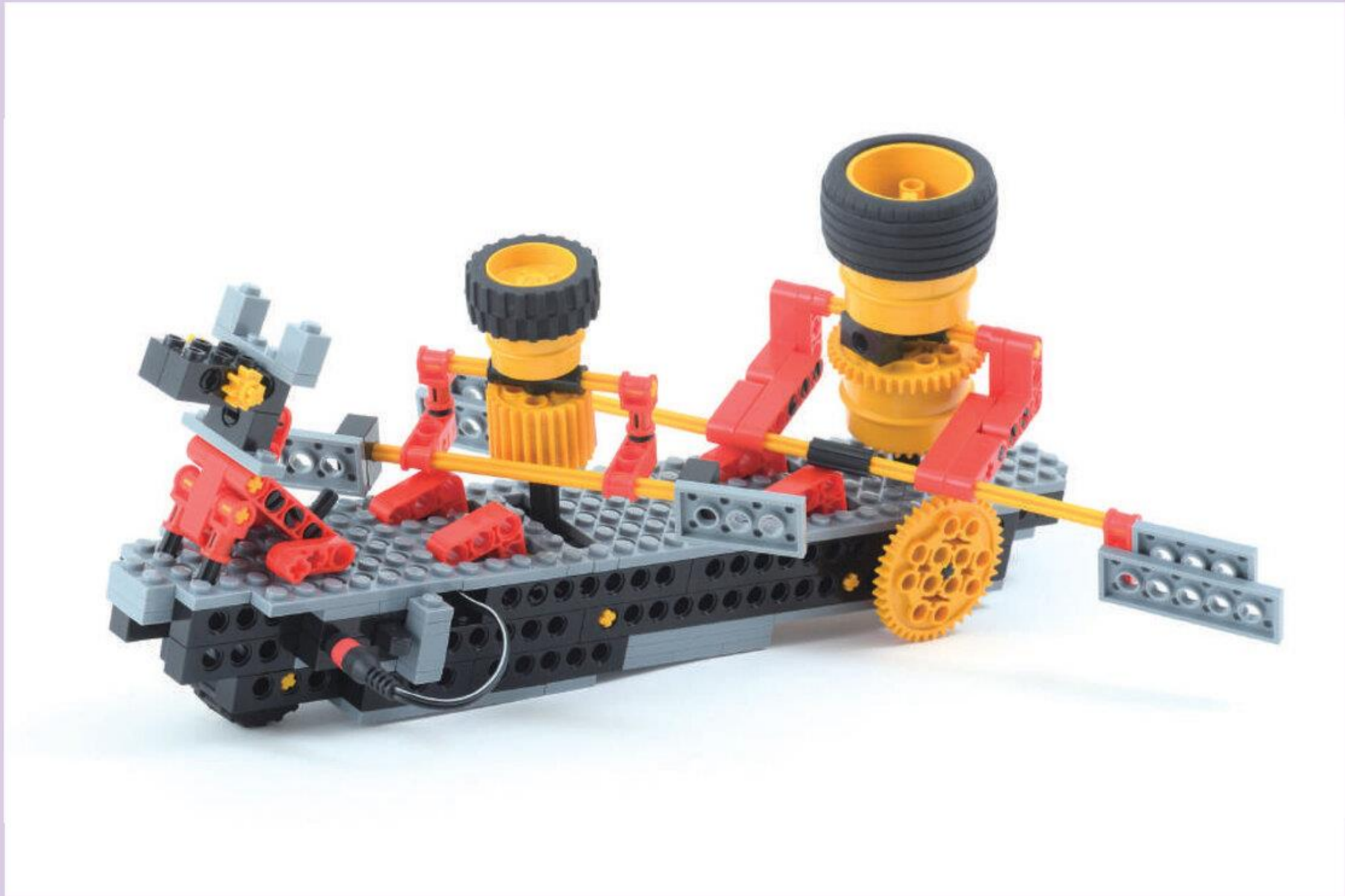

まちがいさがし

めやす 3 ぶん

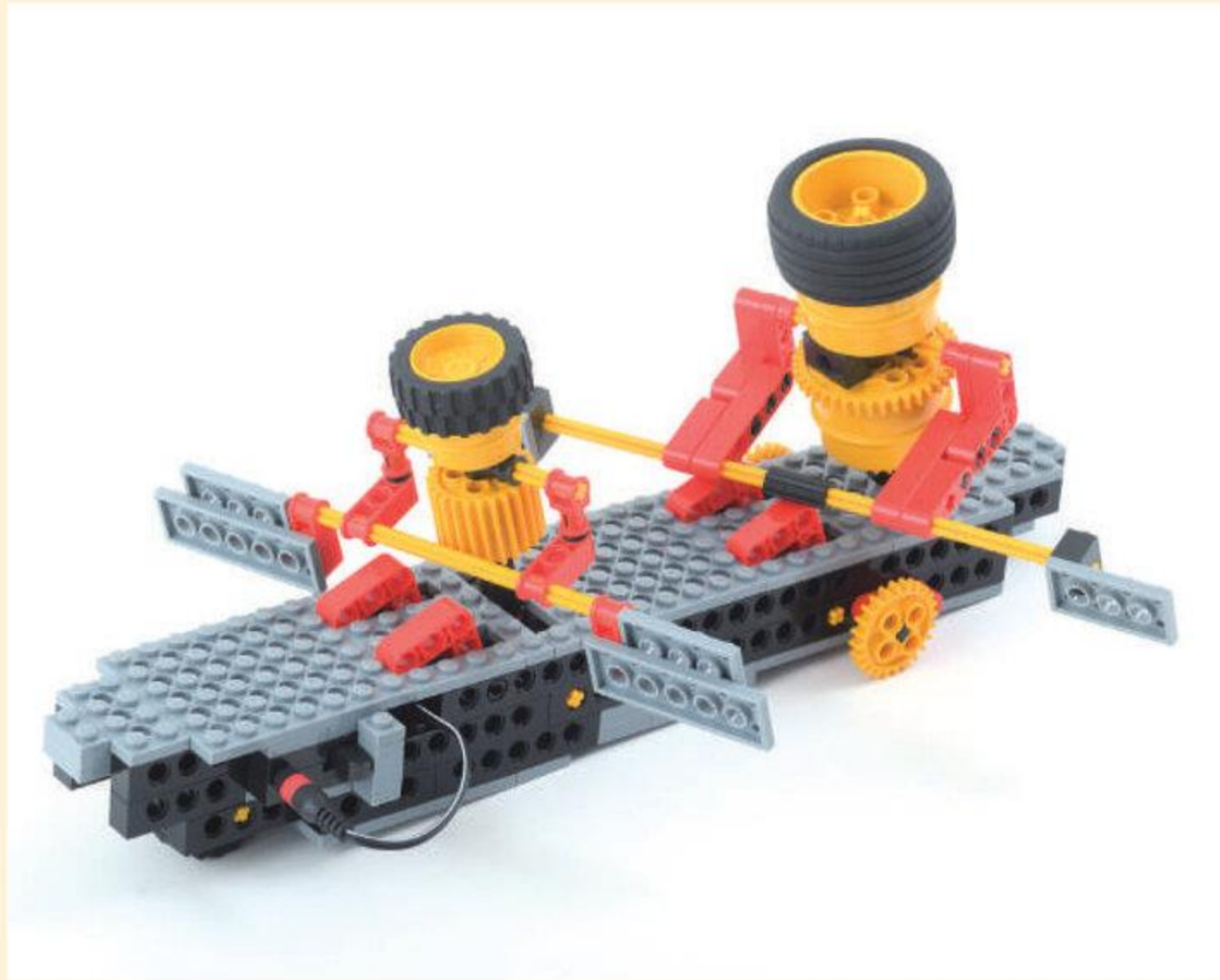

ちがうところを みつけよう
2つあるよ!

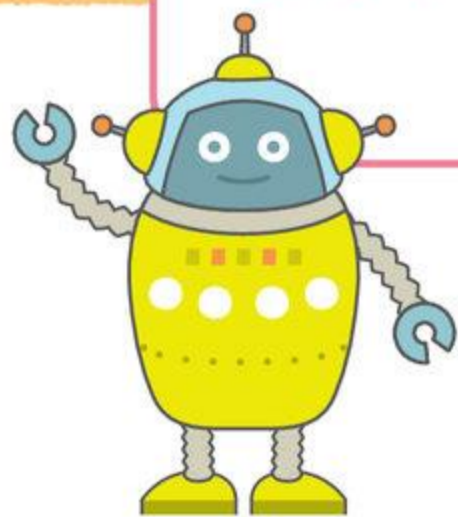



これからつくるロボットを しょうかいするよ

ぶ
れ
ぶ
ら
い
ま
り
い
こ
お
す
プ
レ
プ
ラ
イ
マ
リ
ー
コ
ー
ス

10がっ ^{るほれえる} ロボレール

しゅっぱつ
しんこう



1 ぽんの ^{れえる} レールのうえをすすんで
じどうでとまるよ

11がっ ^{りん} ゆらリン

ぶらんこ
ロボ



じどうてきにぶらんこがゆれる
ロボットだよ

12がっ ^{もってくてく} モッテクテク

はいたつ
ロボット

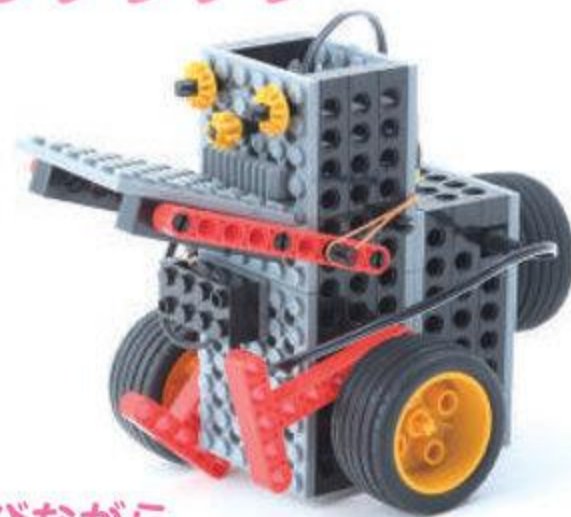

ものはこびながら
まえにすすむロボットだよ

1がっ ^{あるきんぐ} アルキング

はっしん!



にそくほこうであるくロボットだよ

ぶ
ら
い
ま
り
い
こ
お
す
プ
ラ
イ
マ
リ
ー
コ
ー
ス

10がっ ^{えすえるるほろこ} SLロボロコ

じょうききかんしゃ
ロボット



11がっ ^{うおうさおう} うおうさおう

ぶつかり
ロボット



進級したら

みんな、もらえる!

なにいろかは
おたのしみ!!



- 進級月に、お教室からお渡しいたします。
- 2024年10月が進級月の方からご提供を開始します。

※画像はイメージです。実際のものとは異なる場合があります。

※「パイロット/修了証」のカラーは、進級コースによって異なります。

#がんばるSTEAMジュニア応援!

フォトコンテスト

受賞者には、天体望遠鏡や
e-GIFTなど
豪華グッズプレゼント!

2024年9月30日まで



詳しくは
Instagramから▼



※予告なく変更になる場合がございます。

●進級グッズ●

●修了証●

みんなでいっしょに参加しよう!

ヒューマンアカデミージュニア ロボット教室

スペシャル

地区

イベント

開催!!



地区イベントは誰でも気軽に参加可能!

各地区のロボット教室在籍生が改造レースとアイデアロボット発表会で
普段の学びや取り組みの成果を披露!

楽しみ
抽選会も
あるよ!

改造レース部門 全コース

★しょうがいぶつやデコボコがあるコースを進んで、ゴールをめざそう!

これまでに作ったロボットで参加しよう
プレプライマリー：8月「メカビートル」、9月「カヤック」、10月「ロボレール」
プライマリー：8月「ロボフィッシュ」、9月「ロボットしょうぼうたい」、10月「SLロボロボ」
ベーシック：8月「リトルドッグ」、10月「ロボドミーノ」
スタートアップ講座「ロボットカー」でも参加できるよ!

★ボールを打って、高得点をめざそう!

ミドル：10月「ロボバッテリー」

★カーブを曲がってゴールを目指し、ピタッと止まろう!

アドバンス：モーター2個と光センサーを必ず使用し、オリジナルロボットで参加

アイデアロボット発表会 全コース

キミが考えたオリジナルロボットを、みんなの前で
はっぴょうする会だよ。ロボットを動かしたり、
キミのくふうポイントをみんなに聞いてもらおう。

どのコースの子も
さんかできるよ!

名古屋

(中日本地区)

10/27日

名古屋

吹上ホール

エントリー期間 | 2024年9月11日(水)12:00～
9月30日(月)17:00

東京

(東日本地区)

11/23土・24日 東京・日本科学未来館

エントリー期間 | 2024年10月8日(火)12:00～
10月29日(火)17:00

お友達・ご兄弟・一般の方の参加OK!

ロボットを借りて改造レースに参加してみよう!
お友だちや家族と一緒に参加してね!

