



Human

ヒューマンアカデミー ジュニア
STEAMスクール



ロボット教室

ロボットのきょうかしよ

プレプライマリーコース 回

1

ぶらんこロボ「ゆらりん」



★だい1かい

2024ねん

11がつ

にち

なまえ

ちゅうい しょう

ばあっ パーツや でんきぶひんを あんぜんにつかうために

! ばあっ パーツを くちに いれない

くみたてた ばあっ パーツを とりはずすときは、
ぜったいにはをつかてはいけません。
ばあっ パーツを のみこんでは いけません。

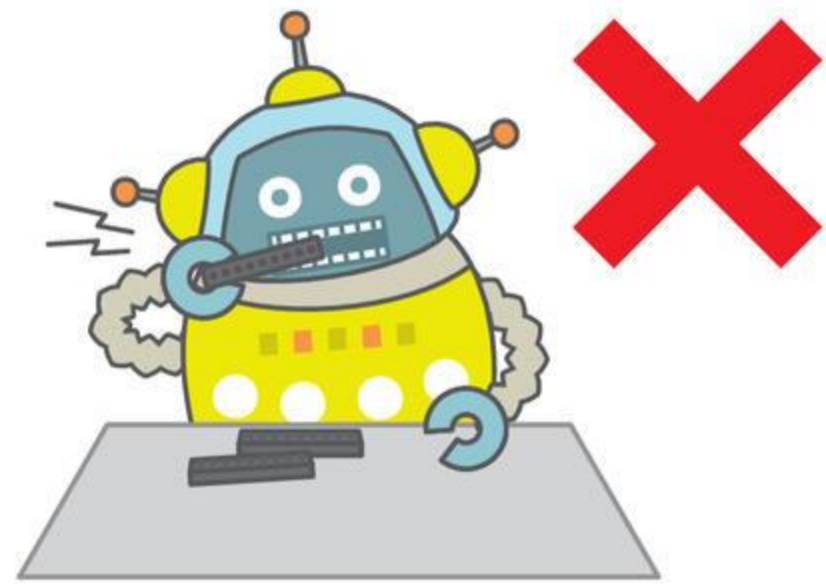

! ぶひんを きずつけない

でんきぶひんを はさみや かつたあ カッターなどで
きずついたり、ばあっ パーツで はさんだりしては
いけません (しゃしん 1)。

こおど や けえぶる コードや ケーブルは、おりまげたり、
ひっぱったりしては いけません。

ぶらぐ の めきさしは、ぶらぐぶぶんを
もって おこないましょう (しゃしん 2)。

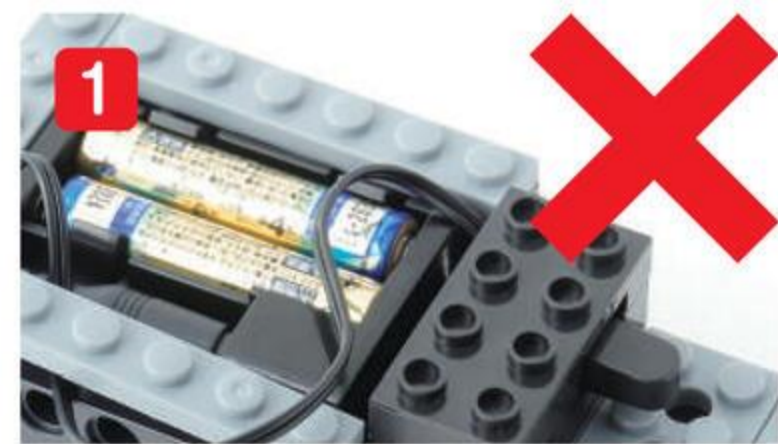

! あつい・におうとき、へんなおとが するとき

ろぼっと ロボットを うごかしたときに、でんちや でんきぶひんが
あつくなったり、へんな においが したり、いつもと ちがうおとが
したばあいは、すぐに ろぼっと ロボットを とめ、せんせいに しらせましょう。
ぬれたてで でんきぶひんを さわってはいけません。

もくじ

だい 1 かい

ロボット <small>ろぼっと</small> のぶんかい	3	10ぶん
かんがえてみよう	3~4	12ぶん
きょう <small>ばあつ</small> のパーツ	5	
きょうのよてい	6	
くみたて		60ぶん
1. かべ	7~9	
2. じめん	10~20	
3. はしら	21~23	
4. ブランコ <small>ぶらんこ</small>	24~30	
5. もう1つの はしら	31~33	
ロボット <small>ろぼっと</small> を うごかさう	34~35	
クイズ <small>くいず</small>	36	3ぶん
かたづけ		5ぶん

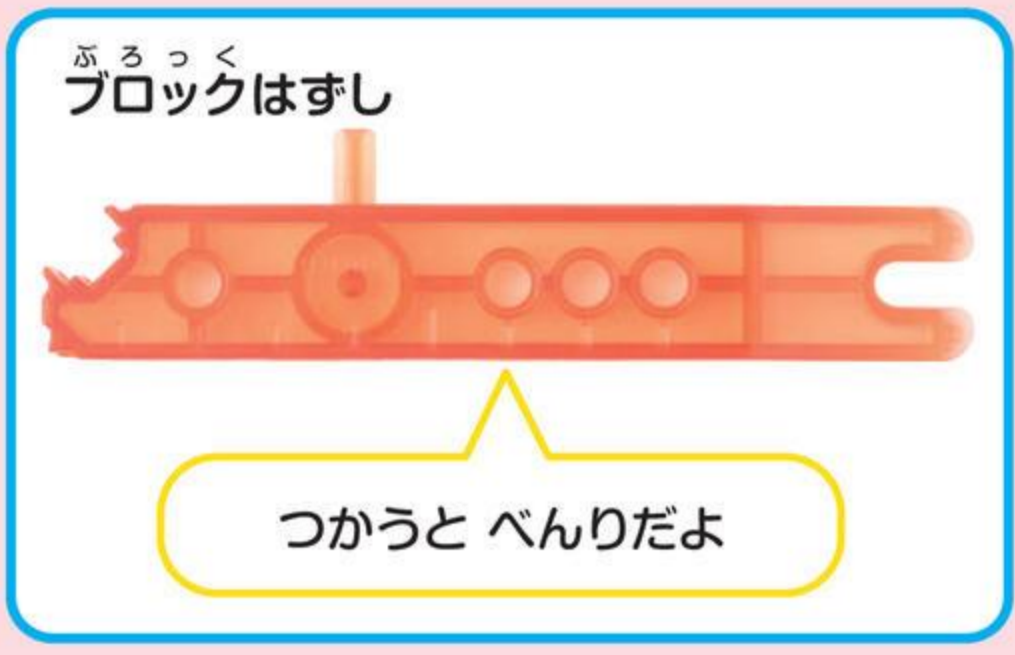

つかうと べんりだよ

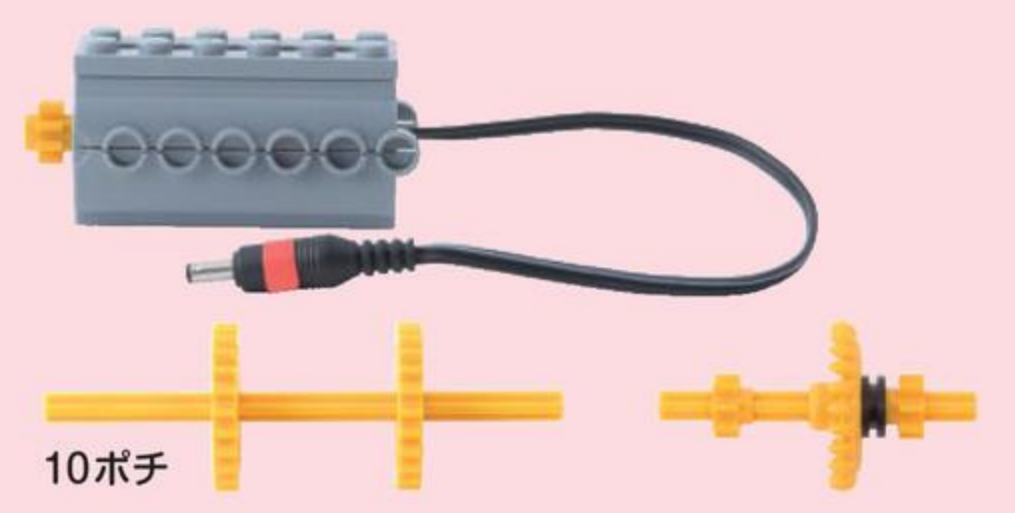

このセットは くずさないでね! またつかうよ



かんがえてみよう

めやす 5 ぶん



ブランコぶらんこに のったことは あるかな?
どんなふう に うごくかな?

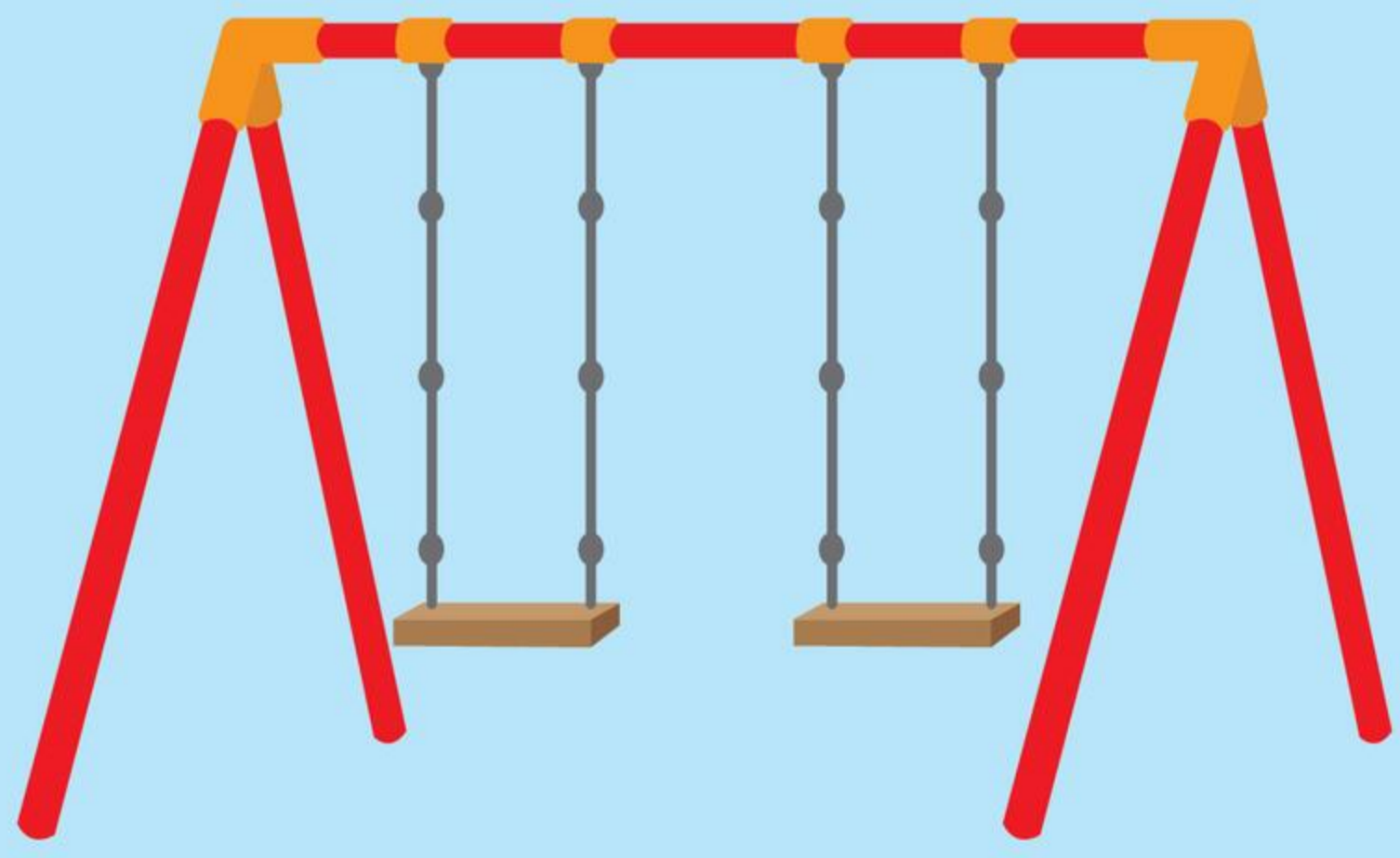



まえと うしろに、いったりきたりするよ!

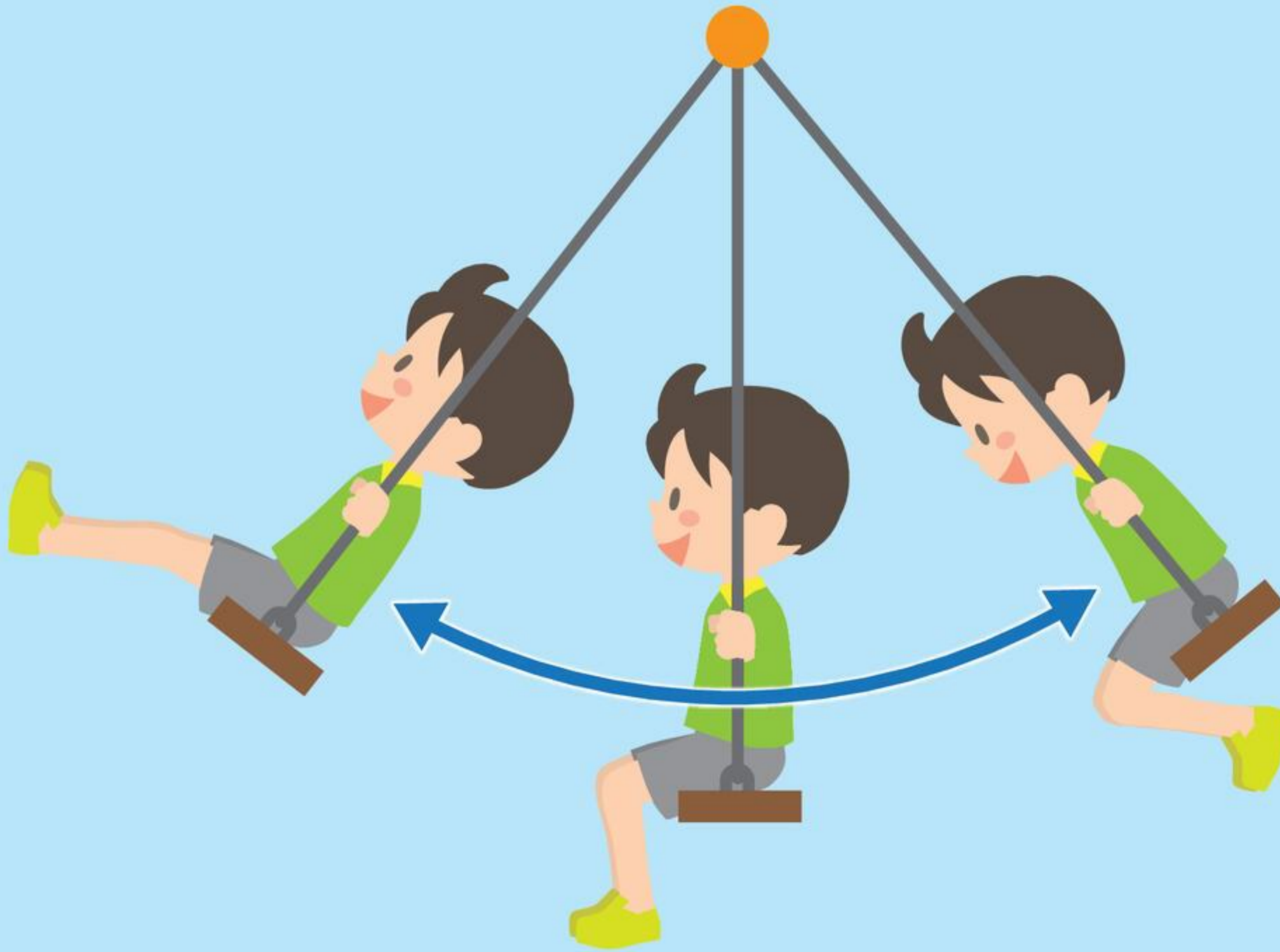

ぶらさがっている いすに すわって、
まえに いったり、うしろに いったり、
ゆらゆらうごくよ

だい 1 かいは ^て手で、
だい 2 かいは ^{も お た あ}モーターで、ゆらゆら うごかすよ





めやす 5 ぶん

ていじょいんと くろすじょいんと
Tジョイント・クロスジョイント

パーツを みつけよう



とくちょう

いろいろな かたちの
アナがあるね!

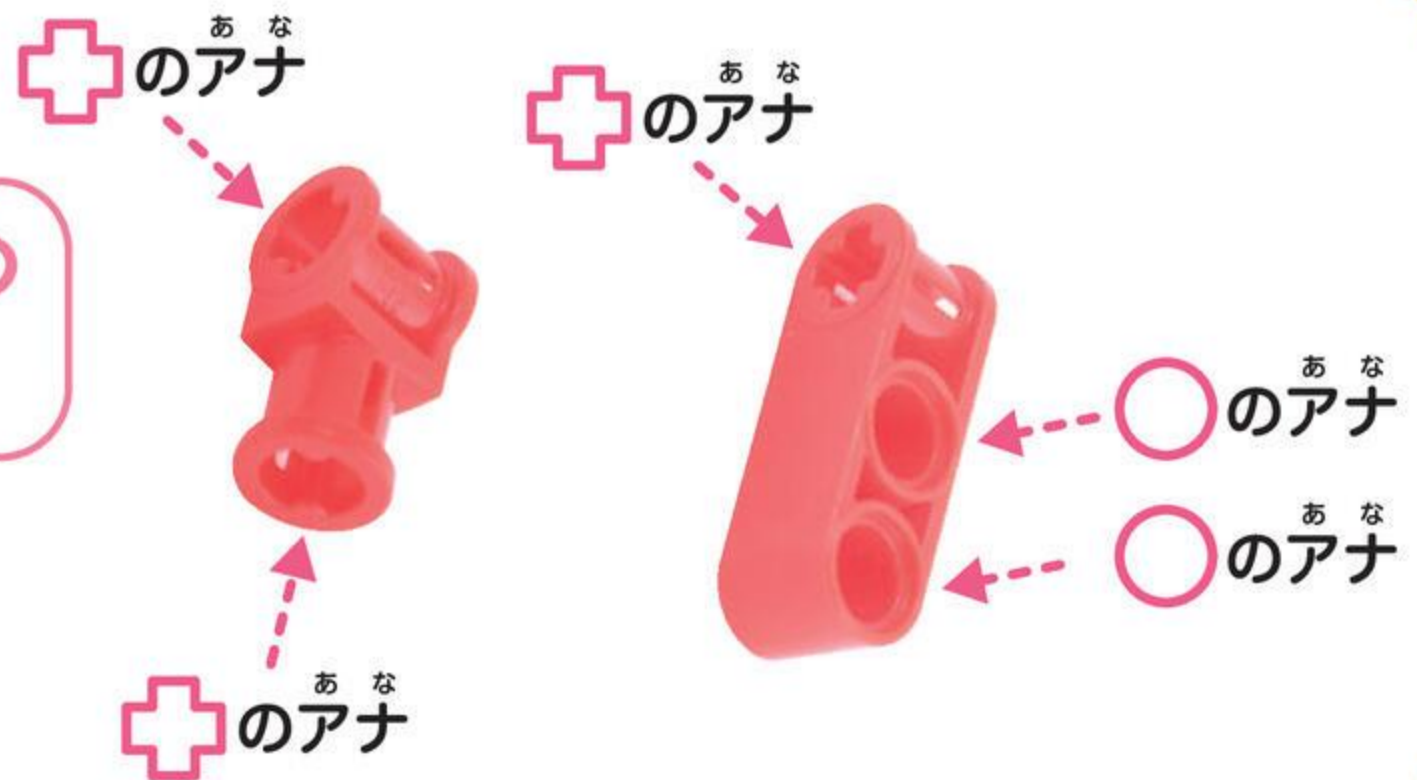
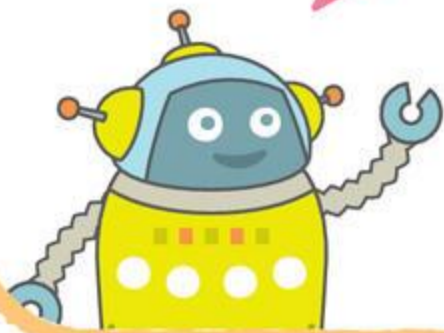

まず たあ
マスターしよう

いろいろな パーツが とりつけられるよ



きょうの よてい

めやす 2 ふん

このじゅんばんでつくるよ!

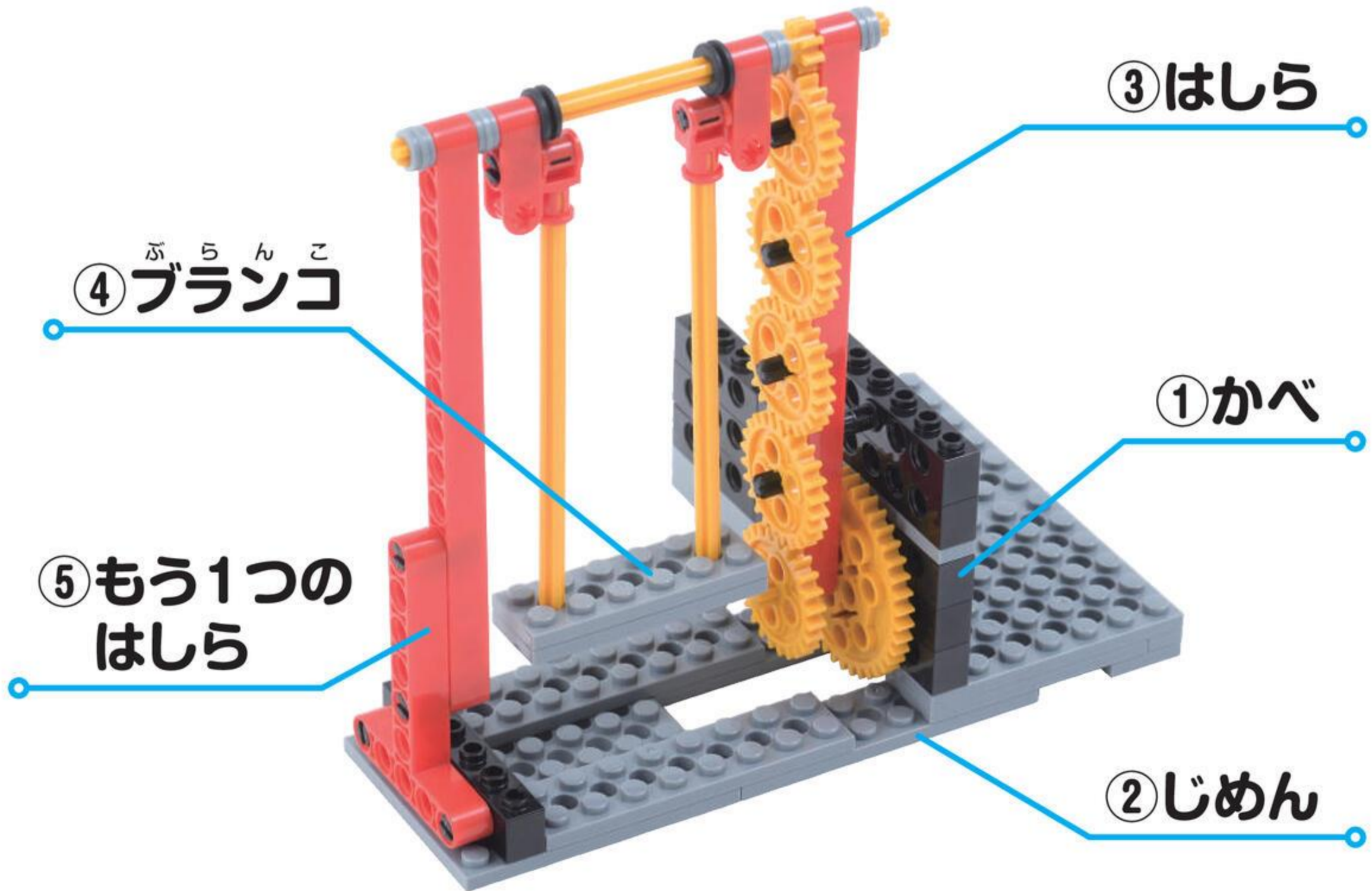

①かべ

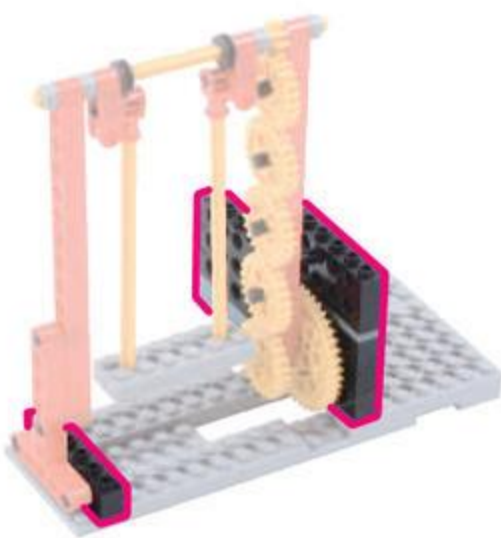

②じめん



③はしら

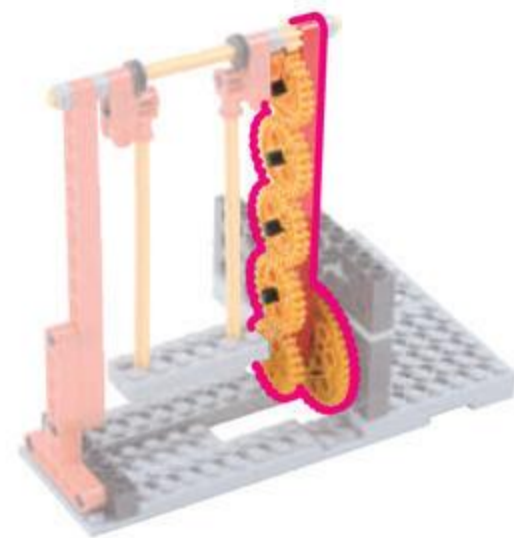

④ブランコ

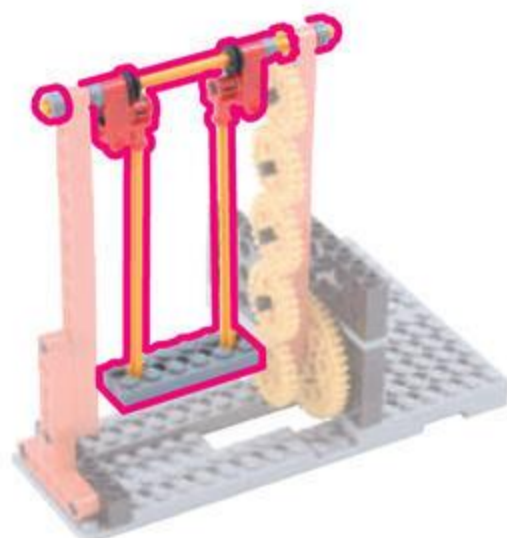

⑤もう1つの はしら

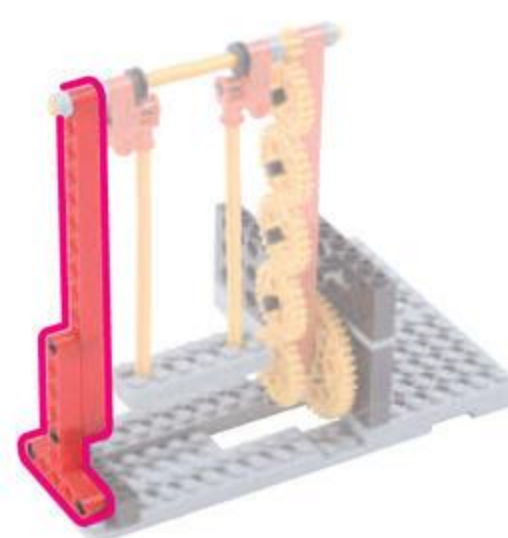

1 かべ めやす 5 ふん

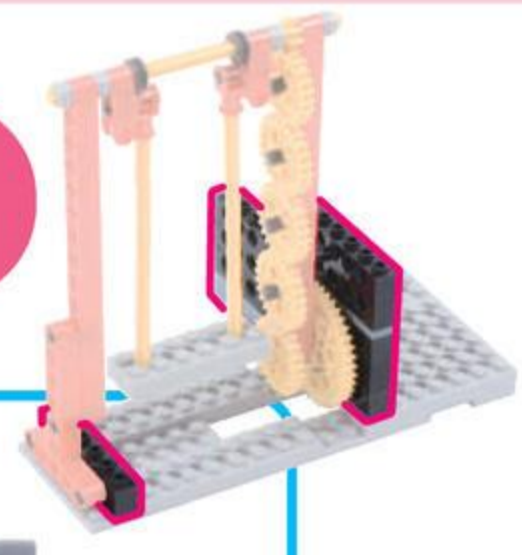

びいむろくほち
ビーム 6 ポチ 2こ



ほそぶれえとろくほち
細プレート 6 ポチ 1こ



1



びいむはちぼち
ビーム 8 ポチ 3こ



びいむよんぼち
ビーム 4 ポチ 3こ

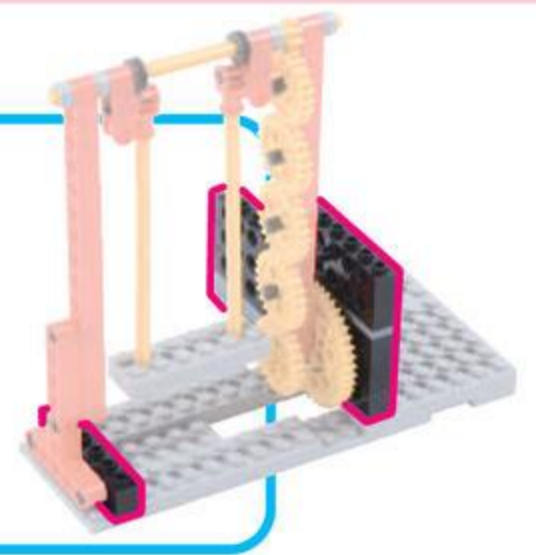

2

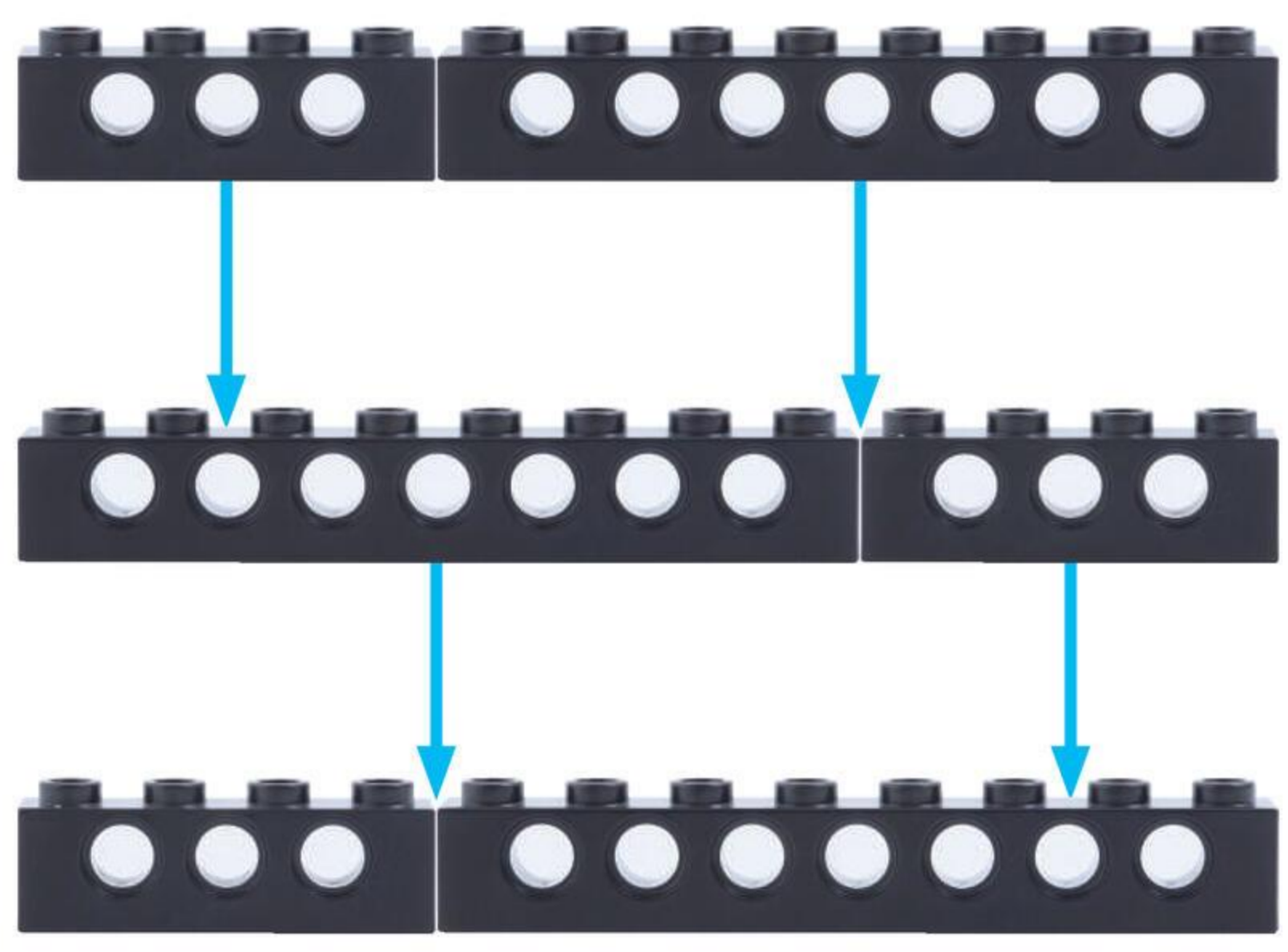

3

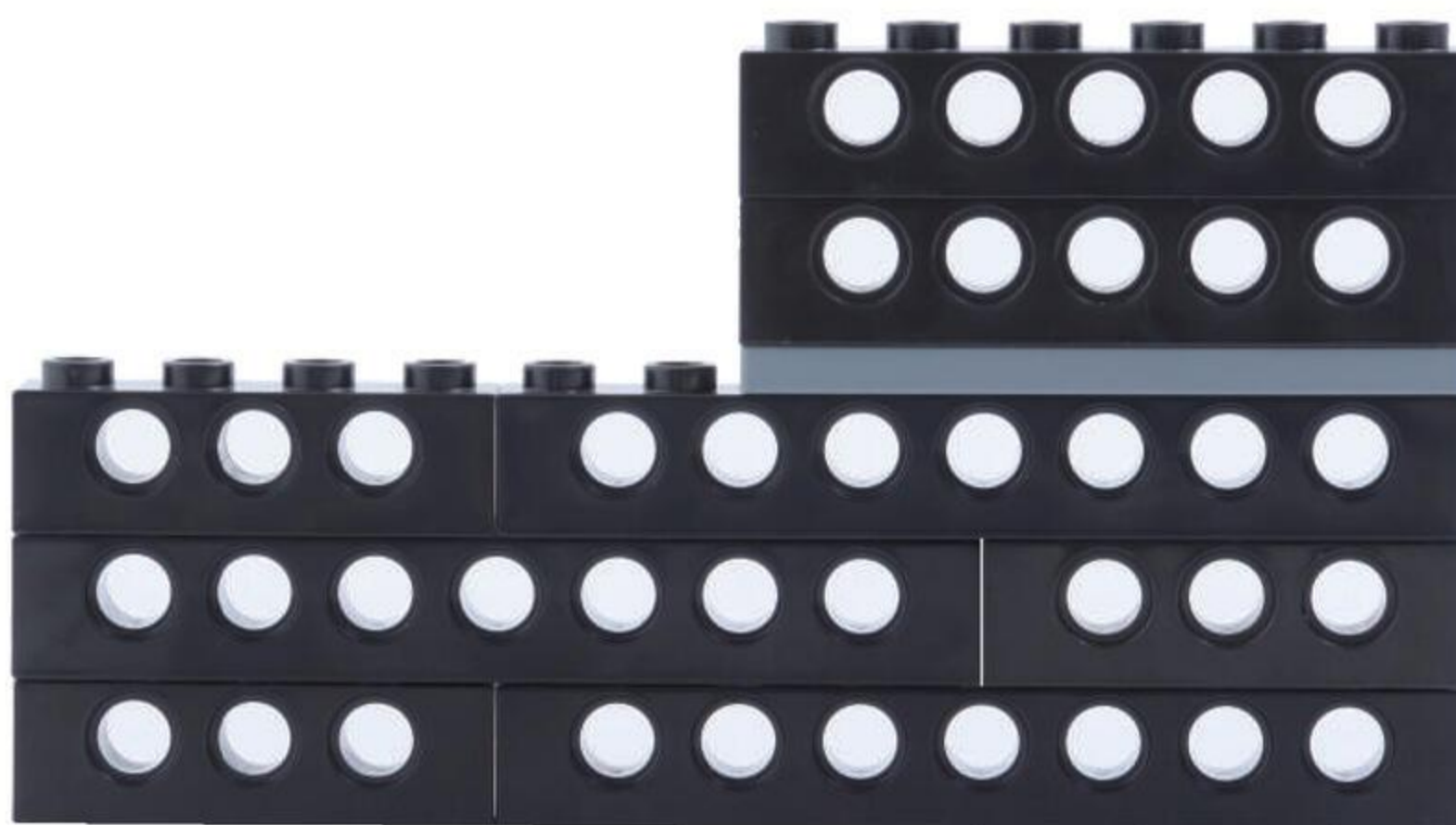
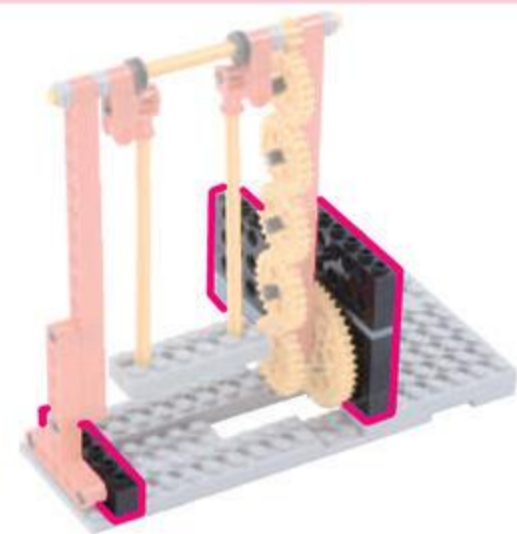

かべが
かんせい!

やったね!

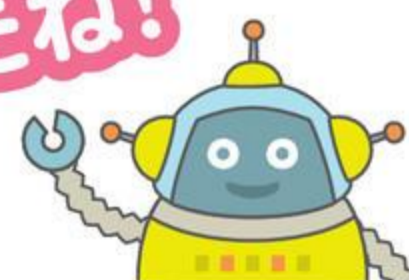

2 じめん

めやす 15 ぶん

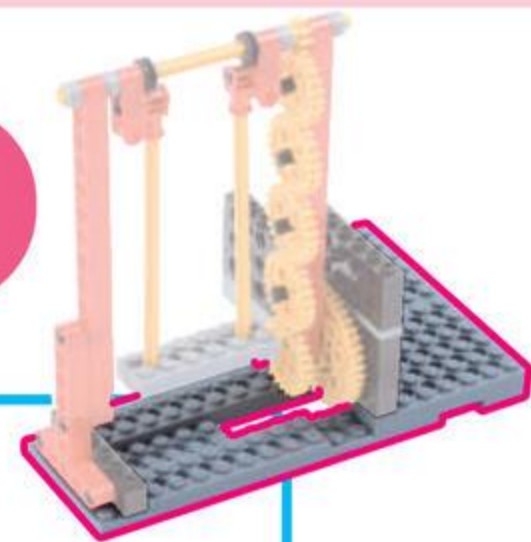

ふれえとろ
プレートL 1こ

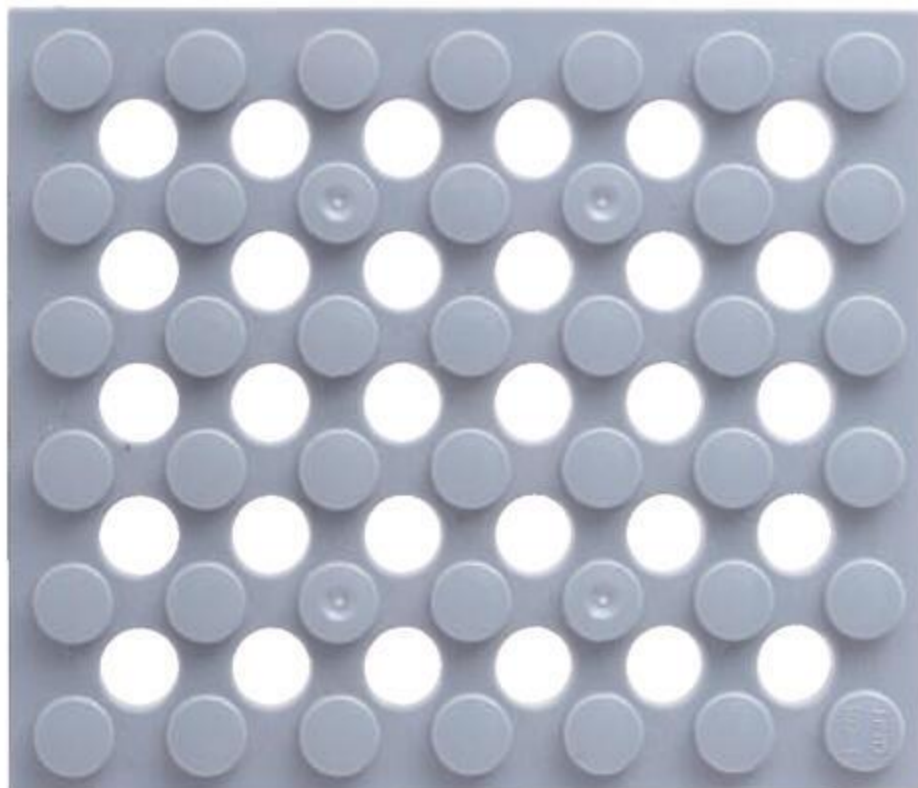

ふとふれえとはちほち
太プレート8ポチ 4こ



1

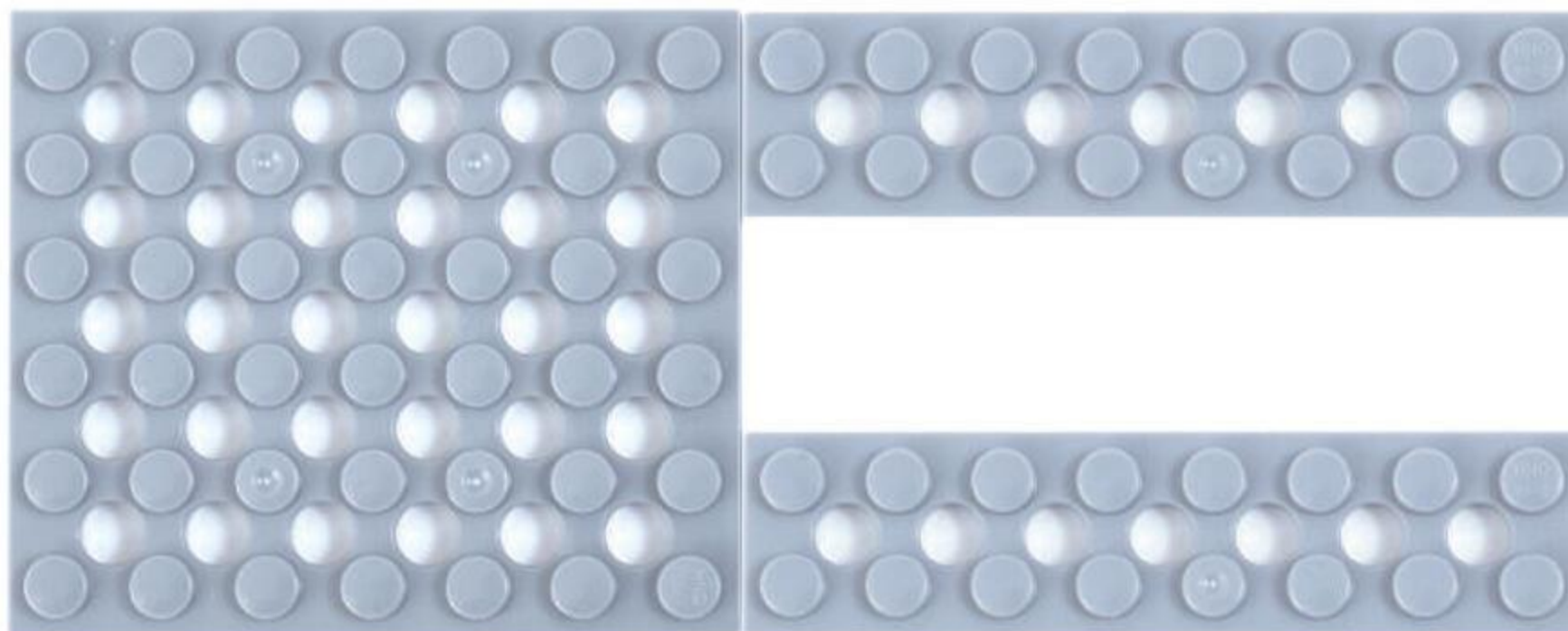

2

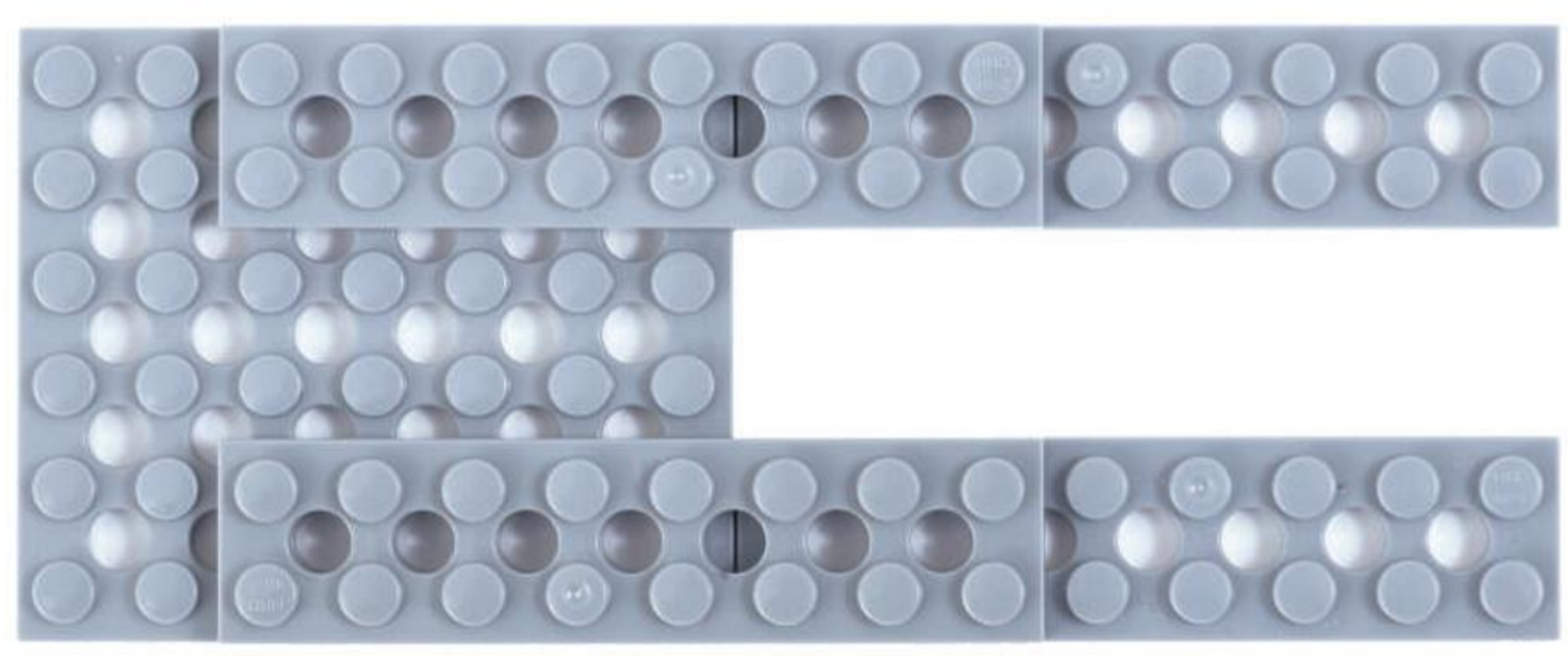
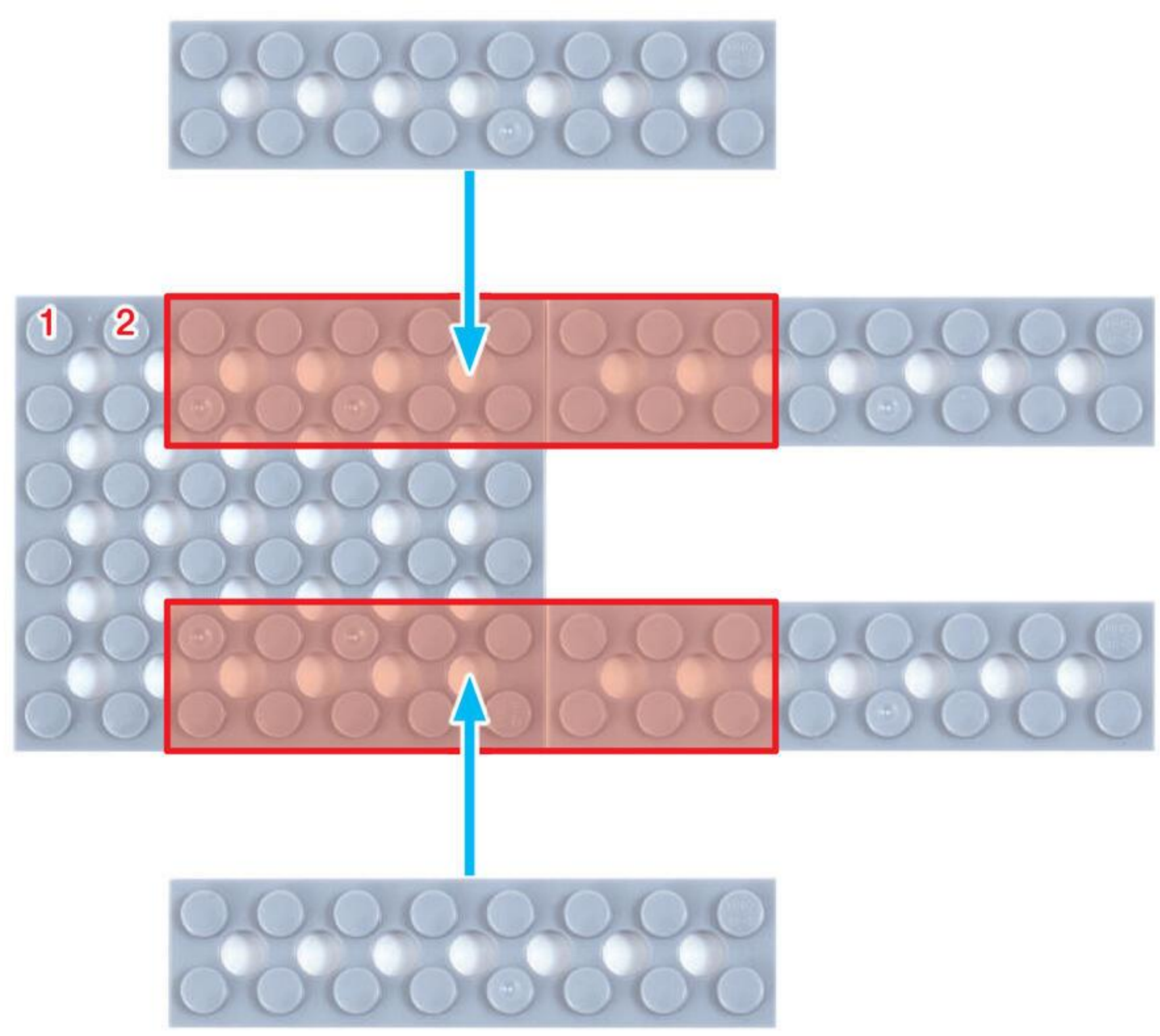
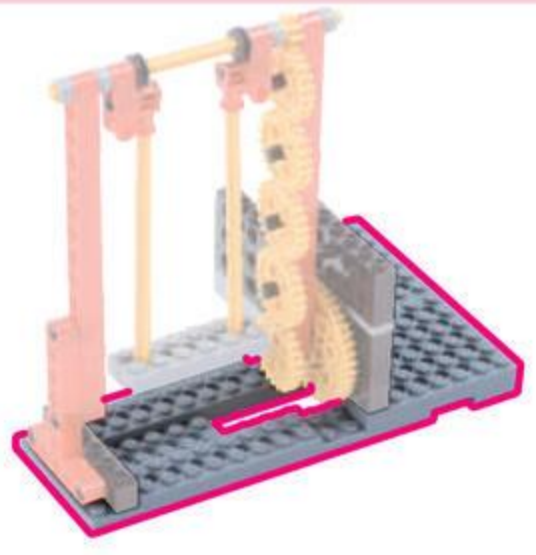

ふとぶれえとろくほち
太プレート 6 ポチ 1 こ



ふとぶれえとはちほち
太プレート 8 ポチ 1 こ

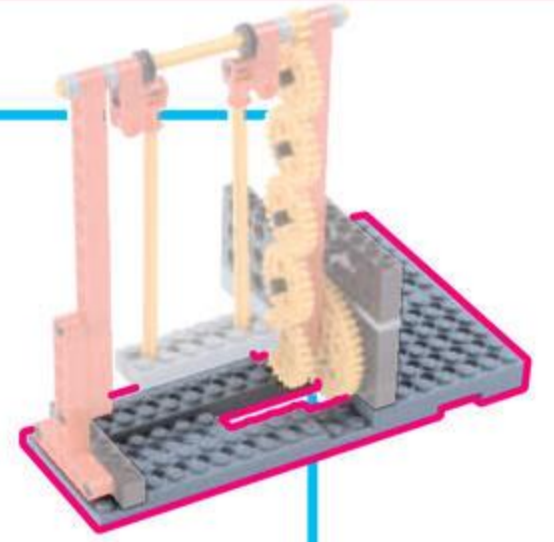

3

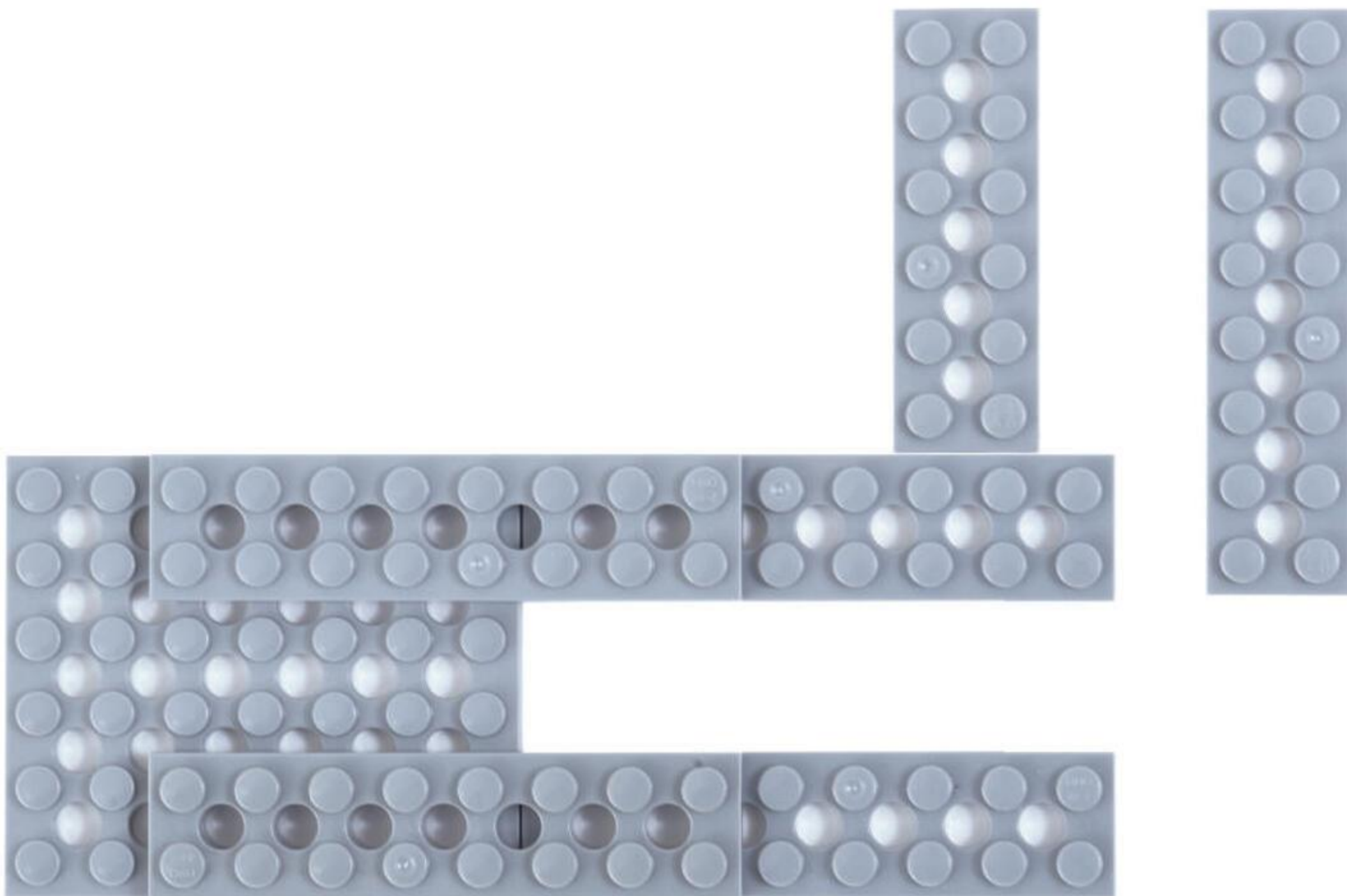

4

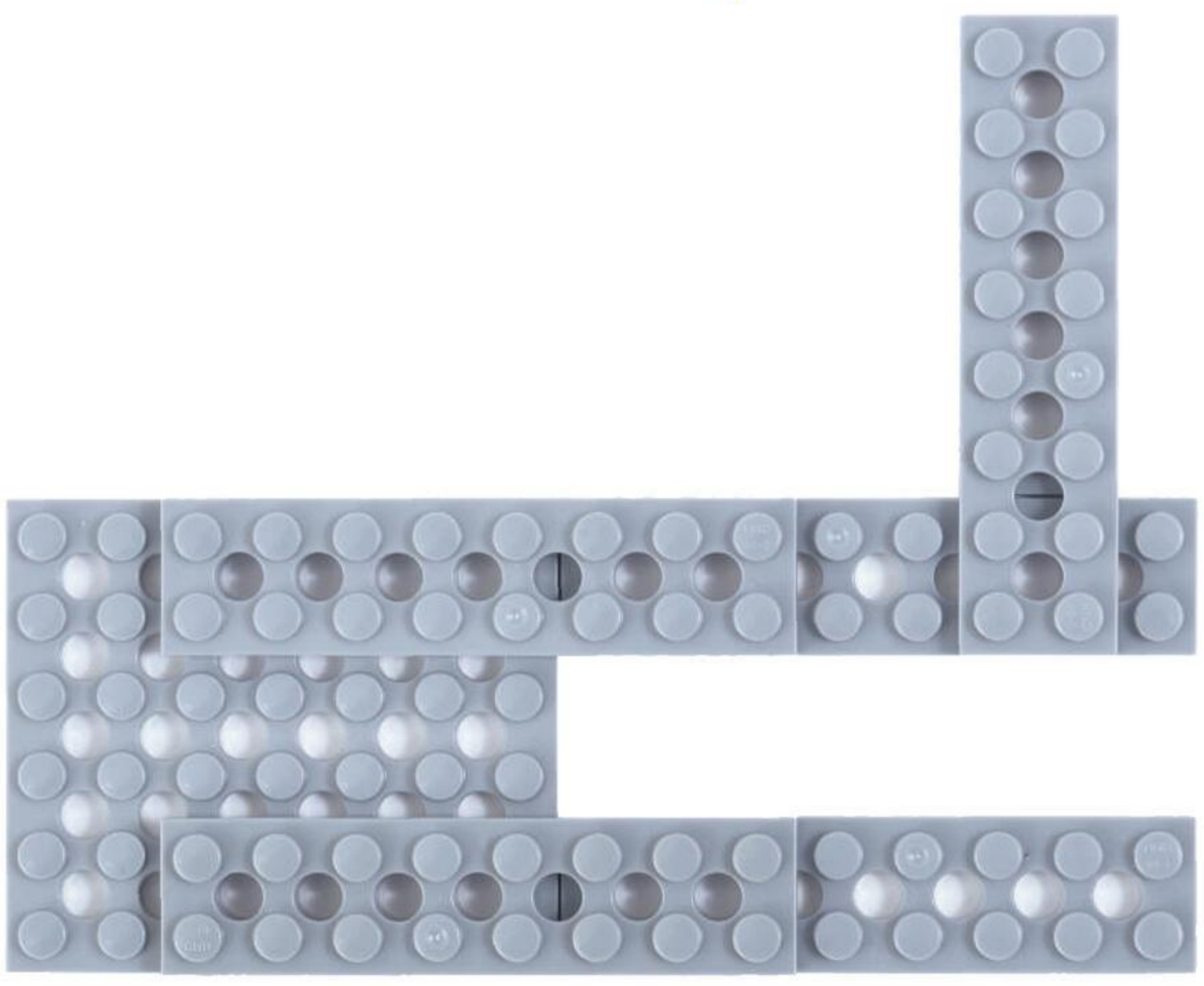
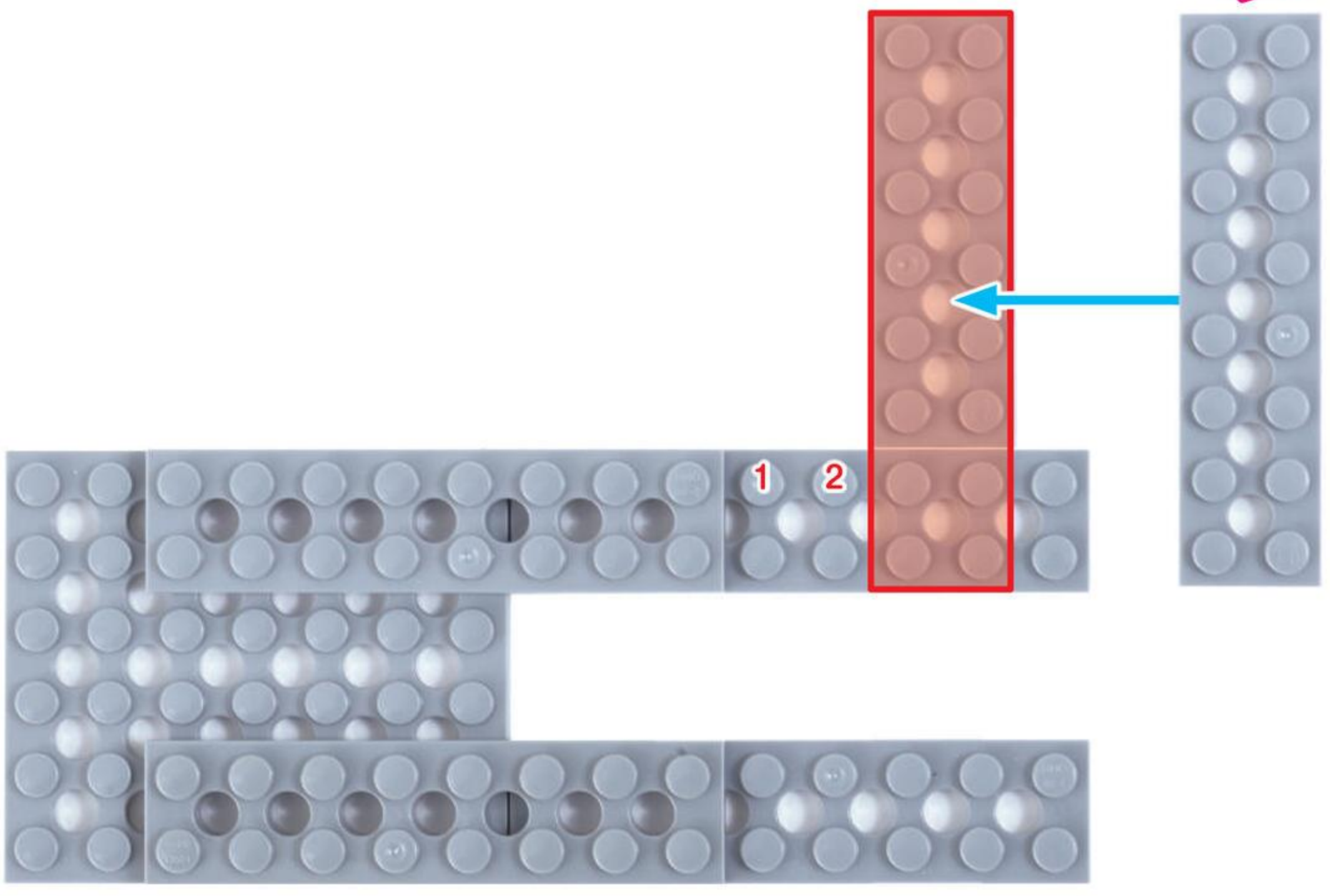

ふとぶれえとよんぼち
太プレート 4 ポチ 1こ



ふとぶれえとはちぼち
太プレート 8 ポチ 1こ

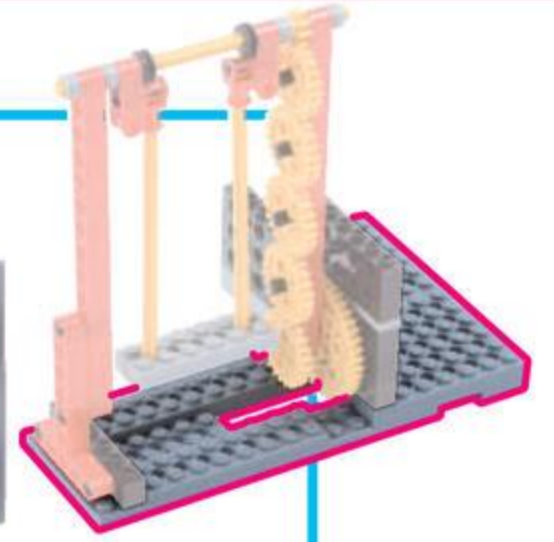

ふとぶれえとろくぼち
太プレート 6 ポチ 1こ



ほそぶれえとろくぼち
細プレート 6 ポチ 1こ



5



6

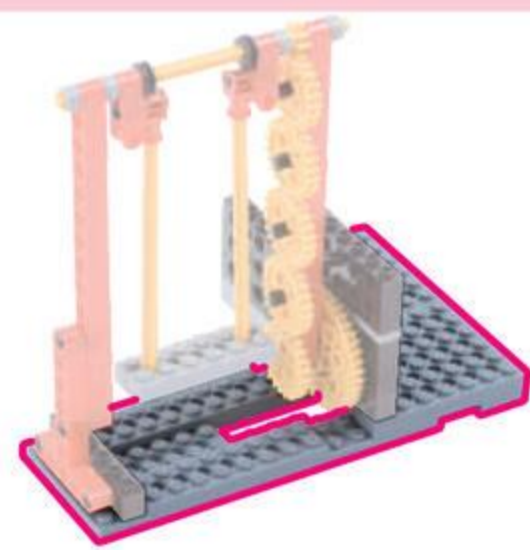
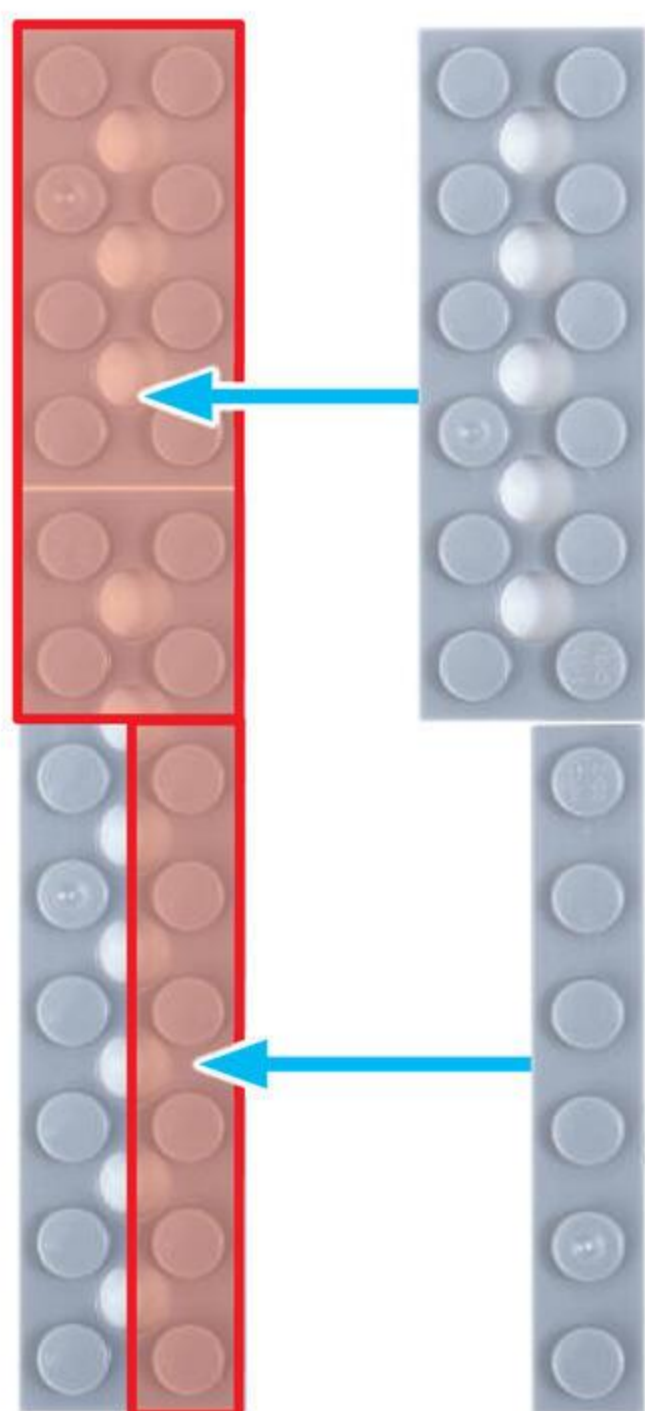

ふとぶれえとろくぼち
太プレート 6 ポチ 1こ



ふとぶれえとよんぼち
太プレート 4 ポチ 1こ

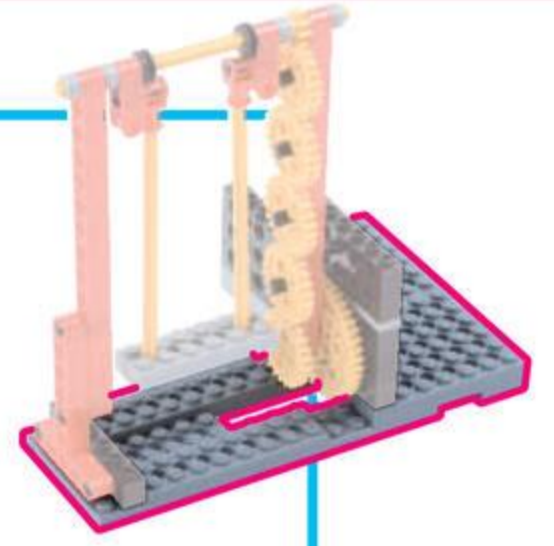

7

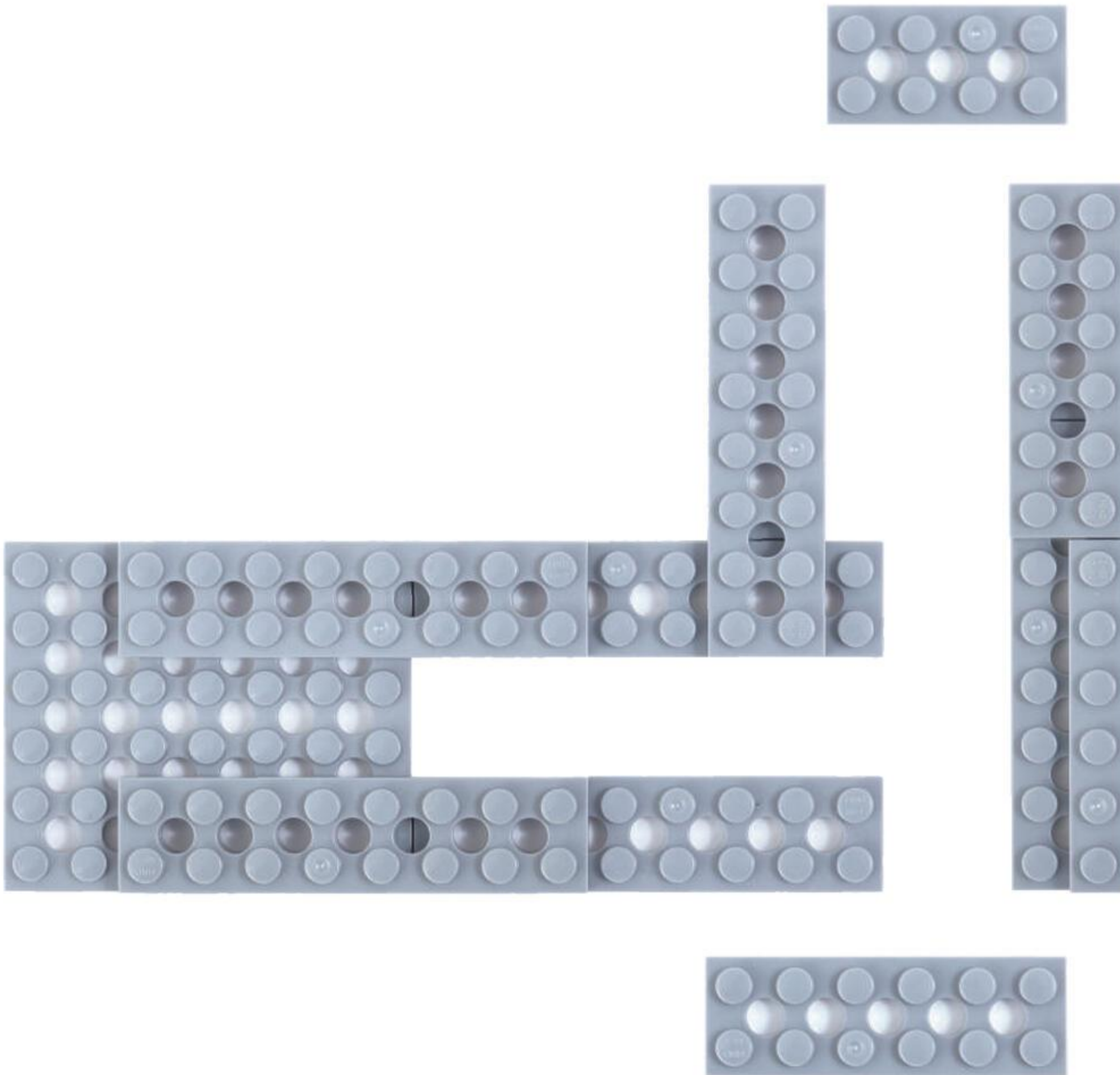

8

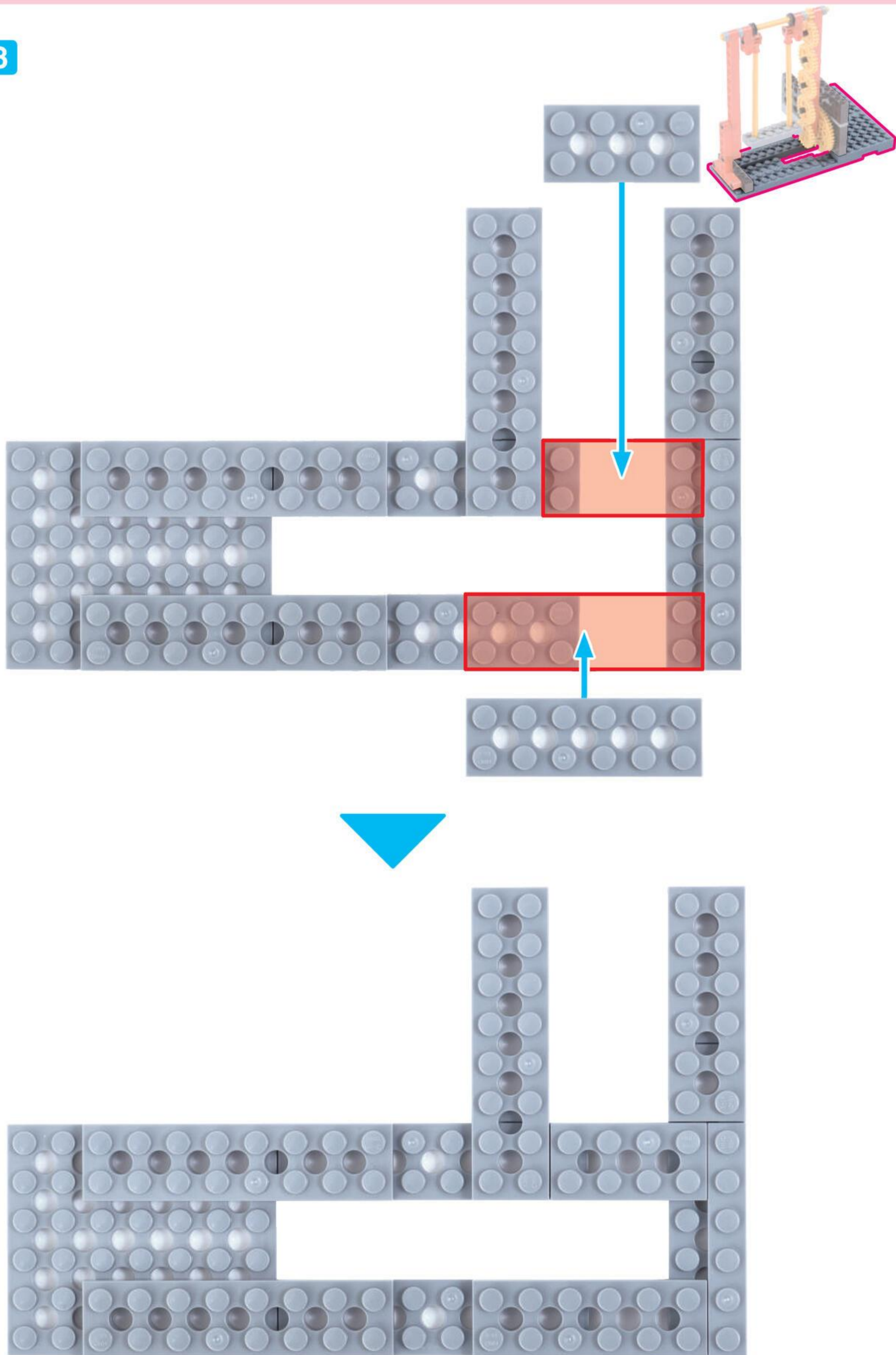

ぶれえとる
プレートL 2こ

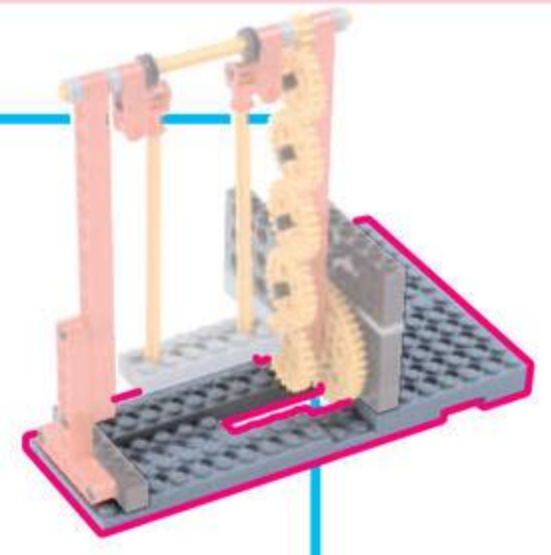
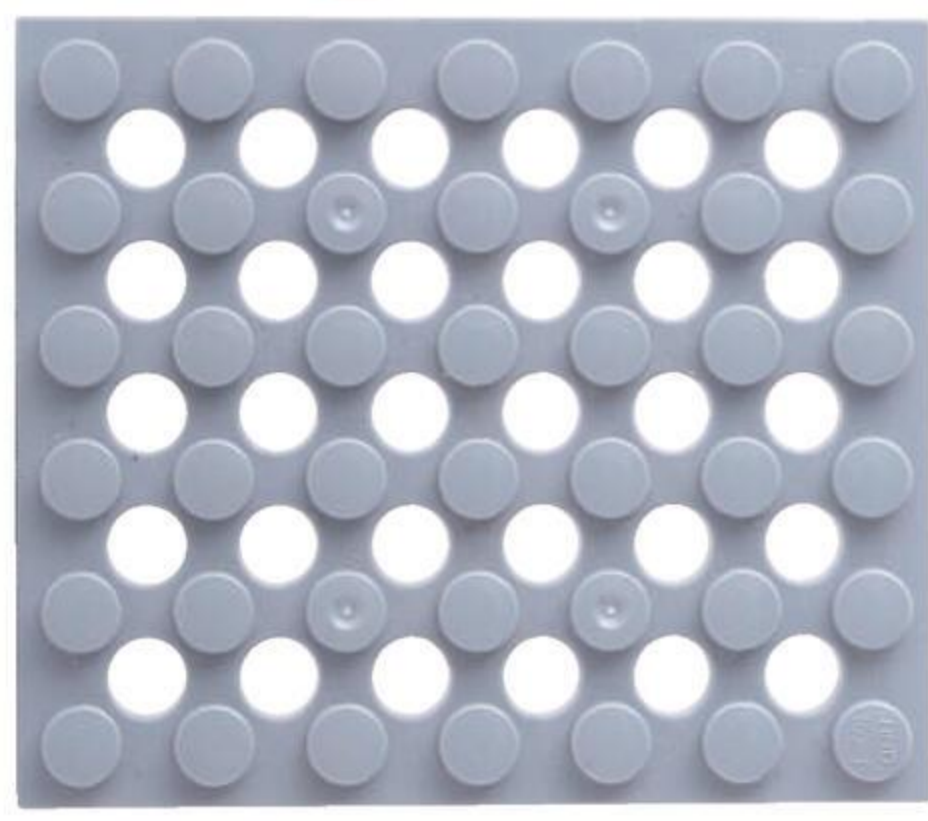

9

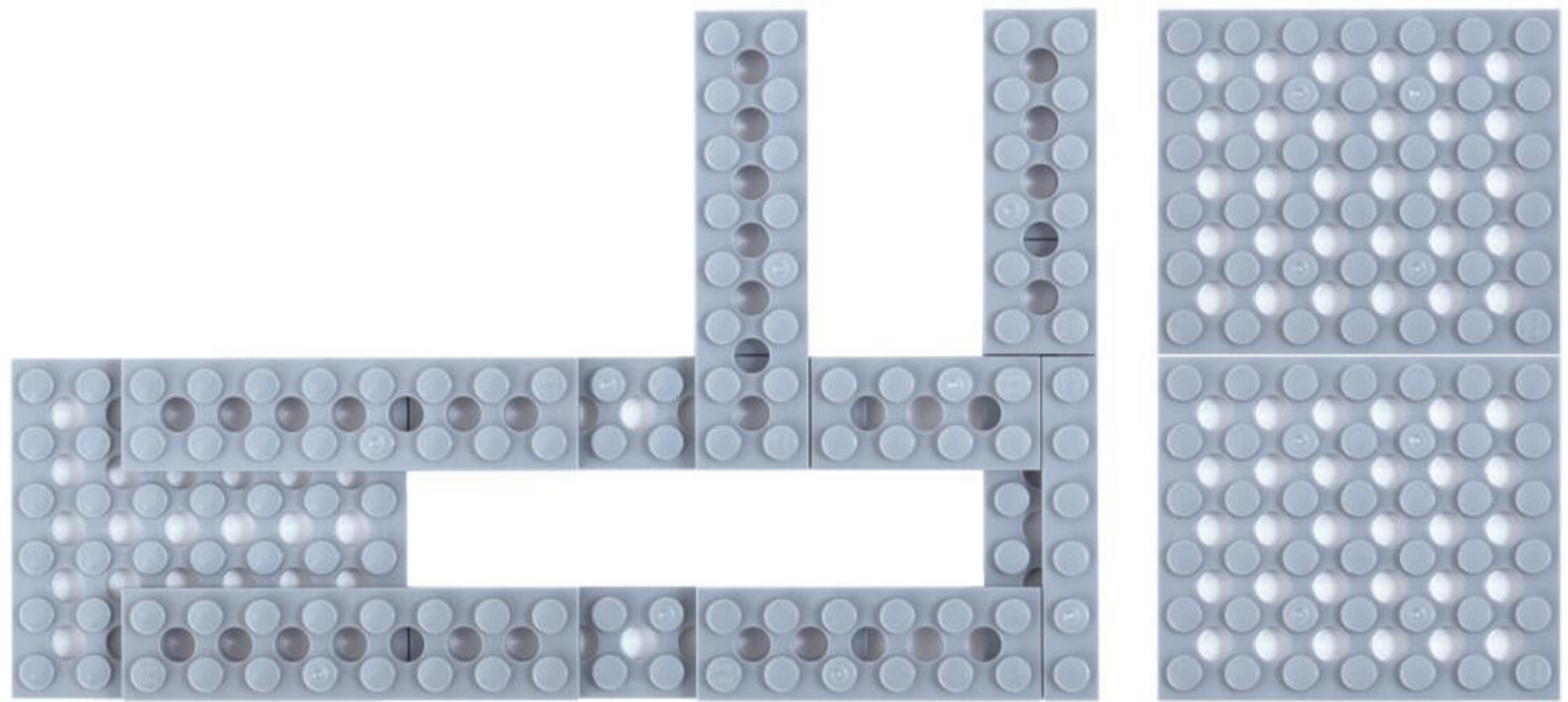

10

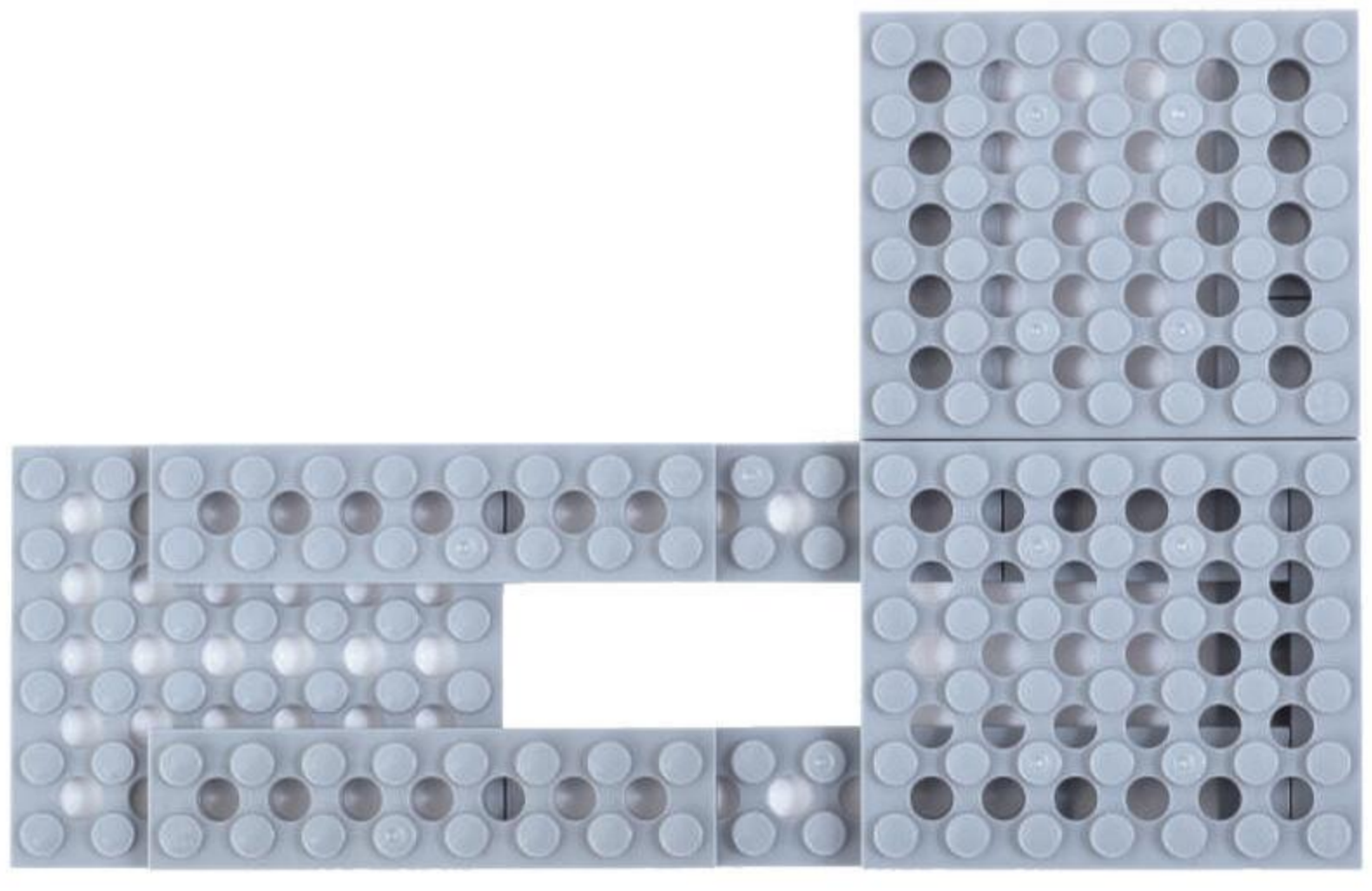
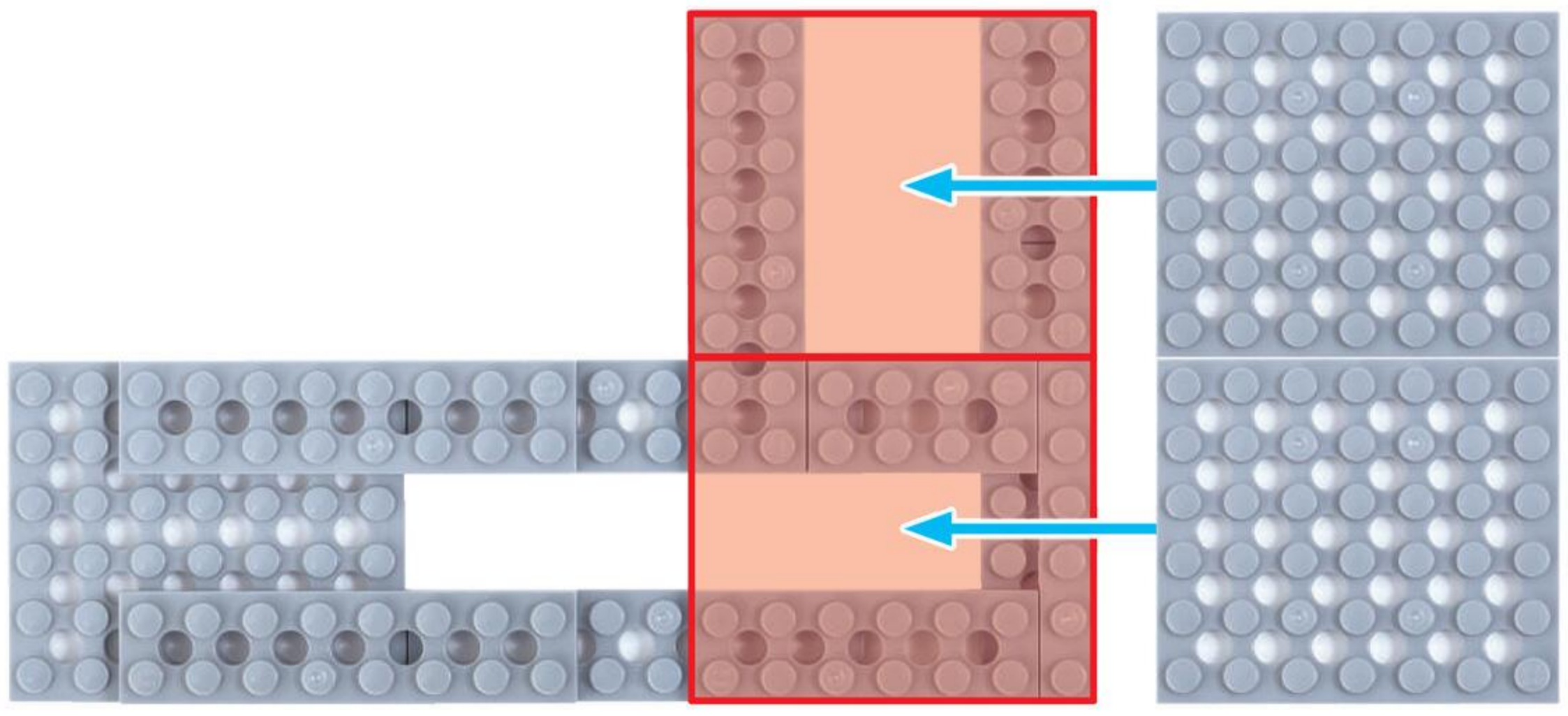

びいむろくほち
ビーム6ポチ 1こ

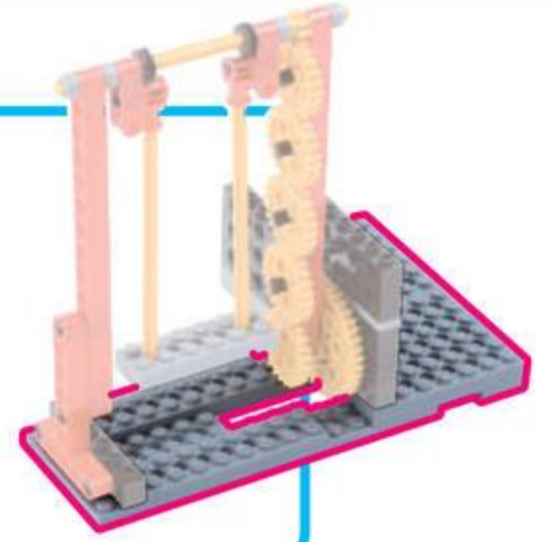

11

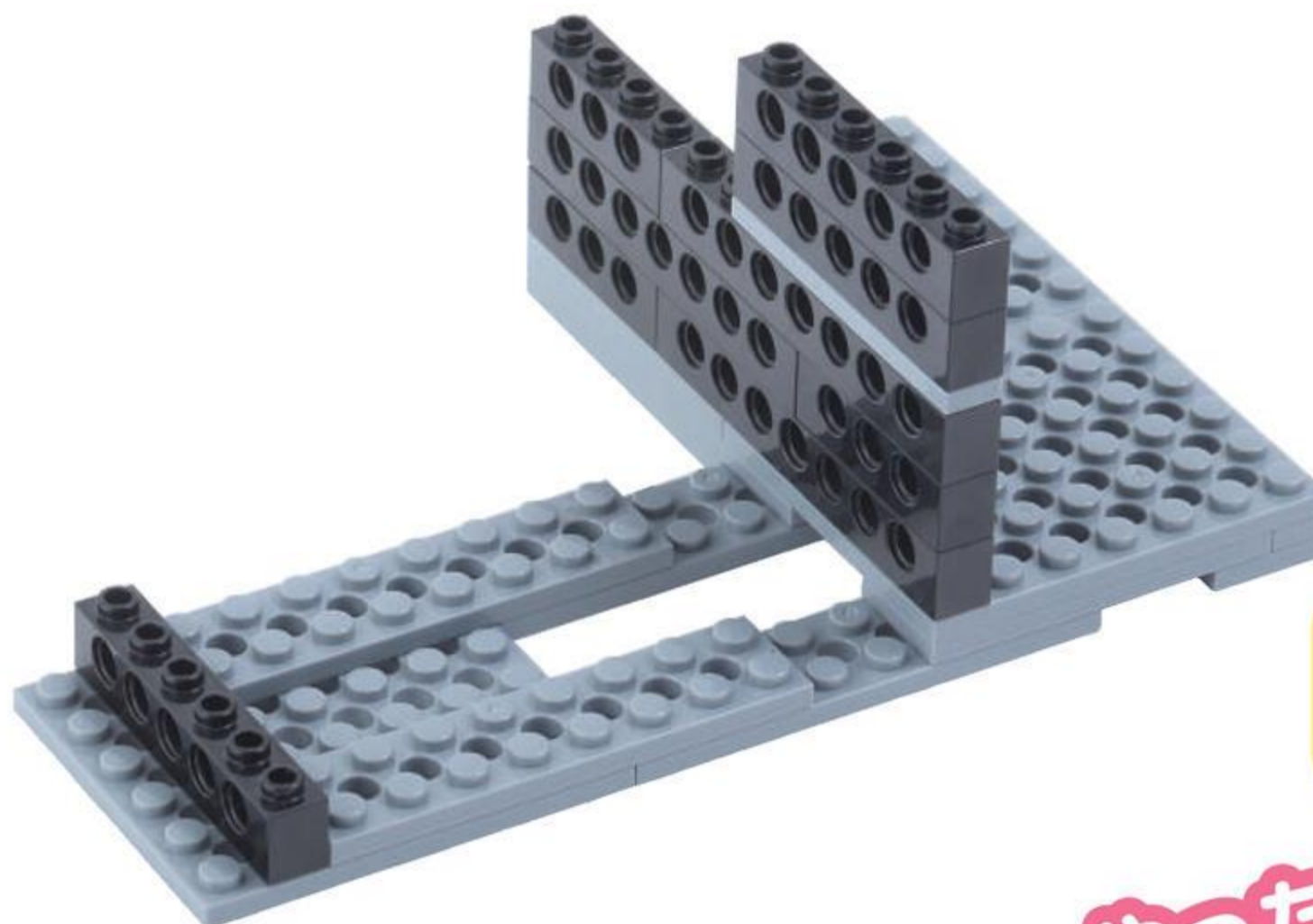
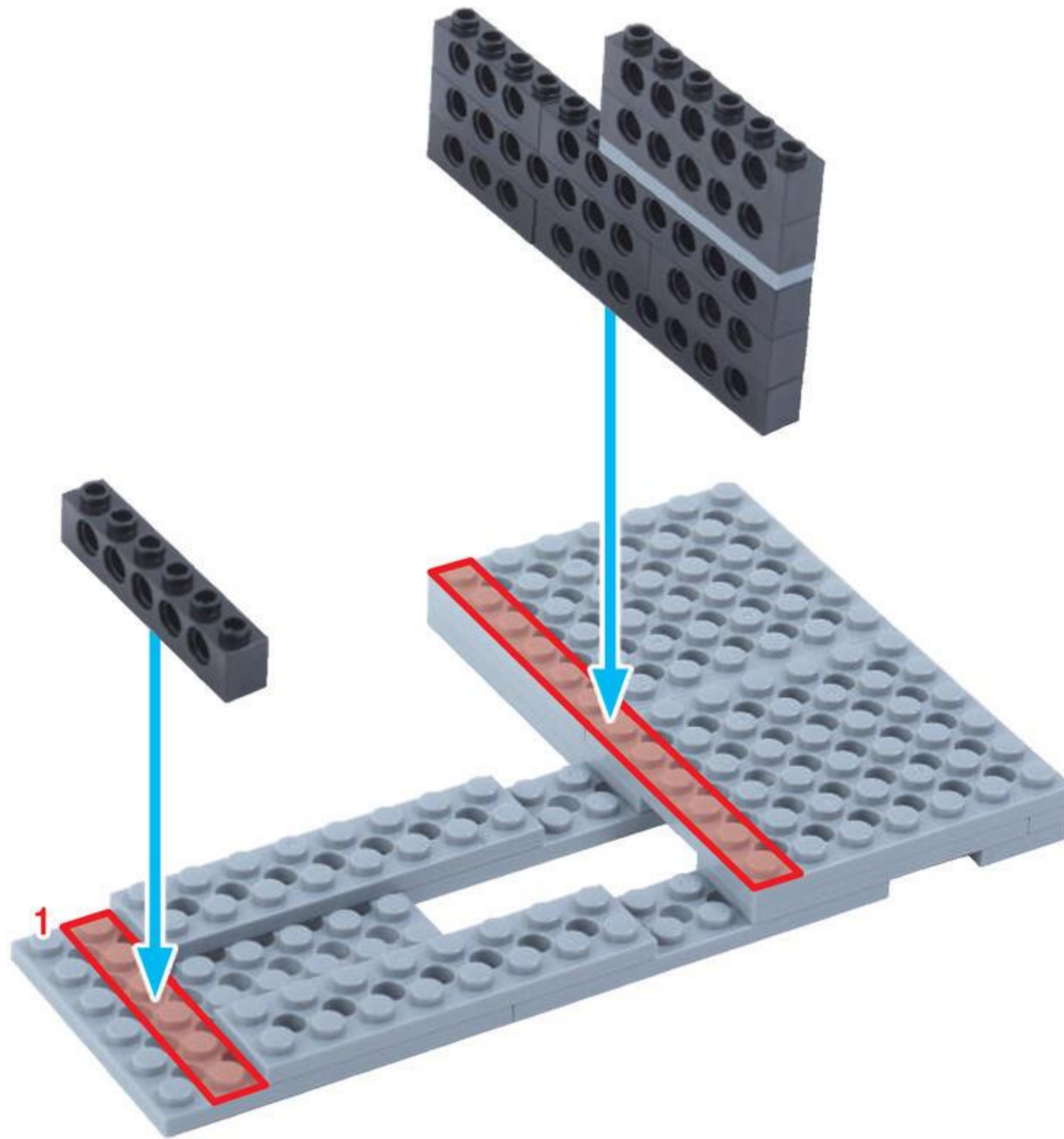

じめんが
かんせい!

やったね!

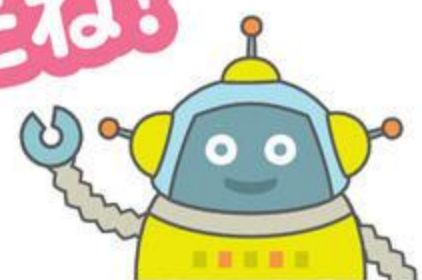

3 はしら めやす 10 ぶん

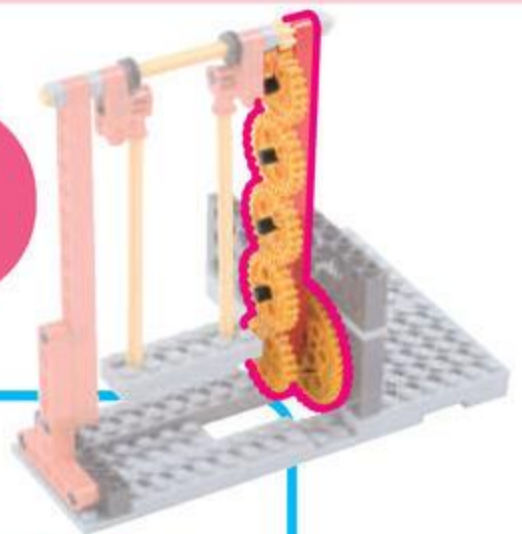

ろっど ^{しゅうご} ^{あな} 15 アナ 1 こ

しゃふと ^ご ^{ぼち} シャフト 5 ポチ 1 こ

ながさに ちゅうい

しゃふと ^{ぺぐ} シャフト ぺぐ 4 こ

ぺぐ ^{える} 1 こ

1

むきに ちゅうい

こちらを さしこむ

ギア L 1こ

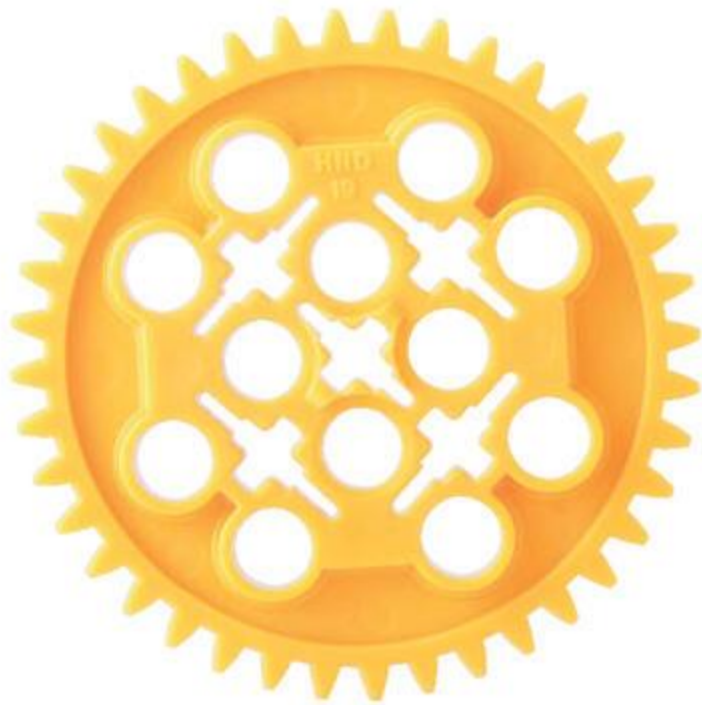

ギア M 5こ

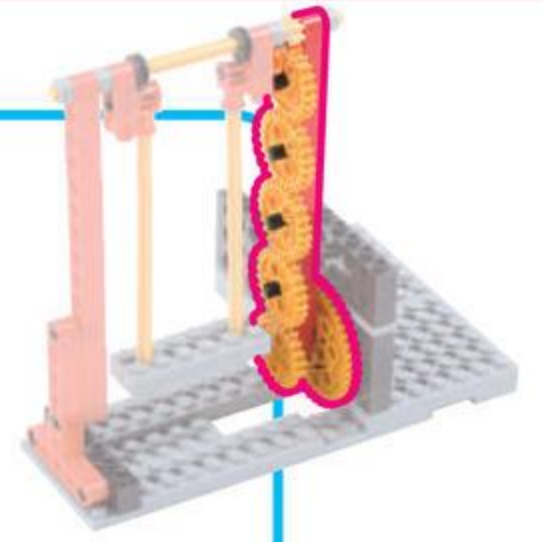
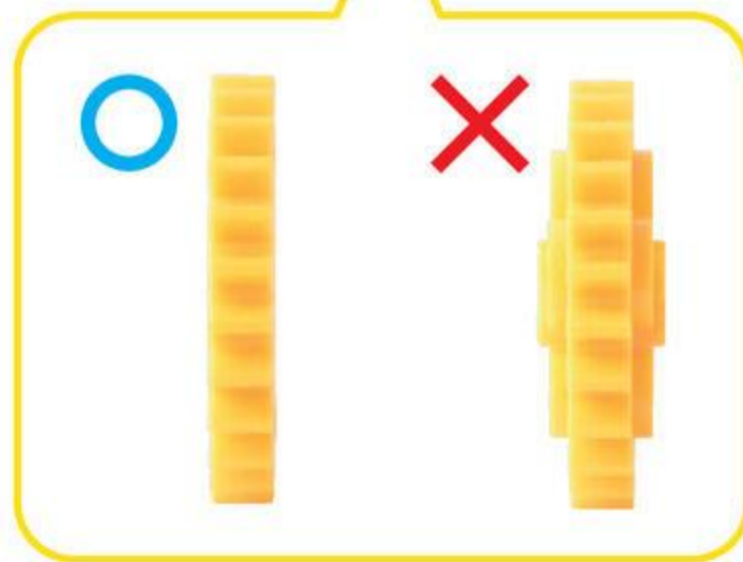

2

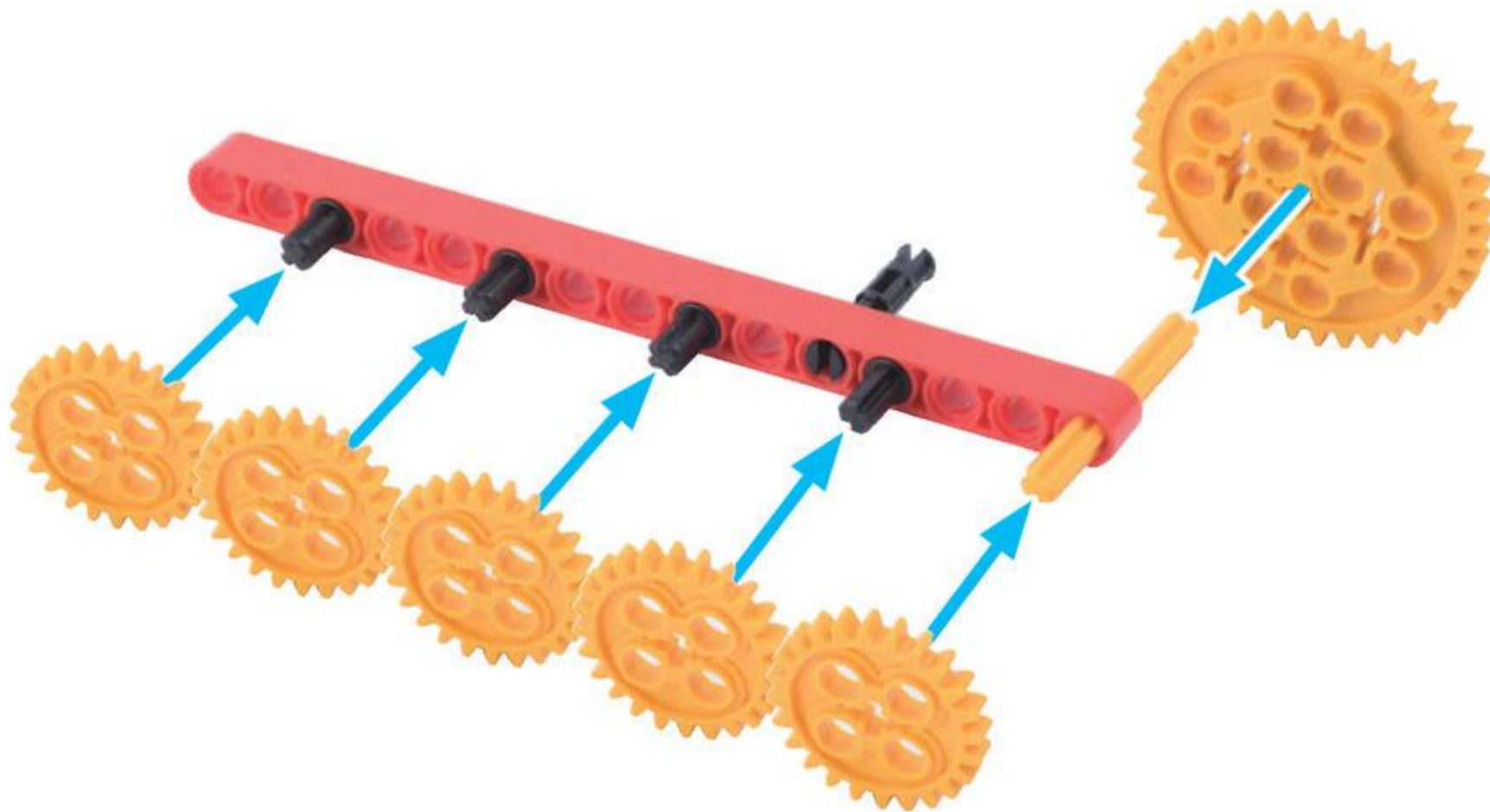

3

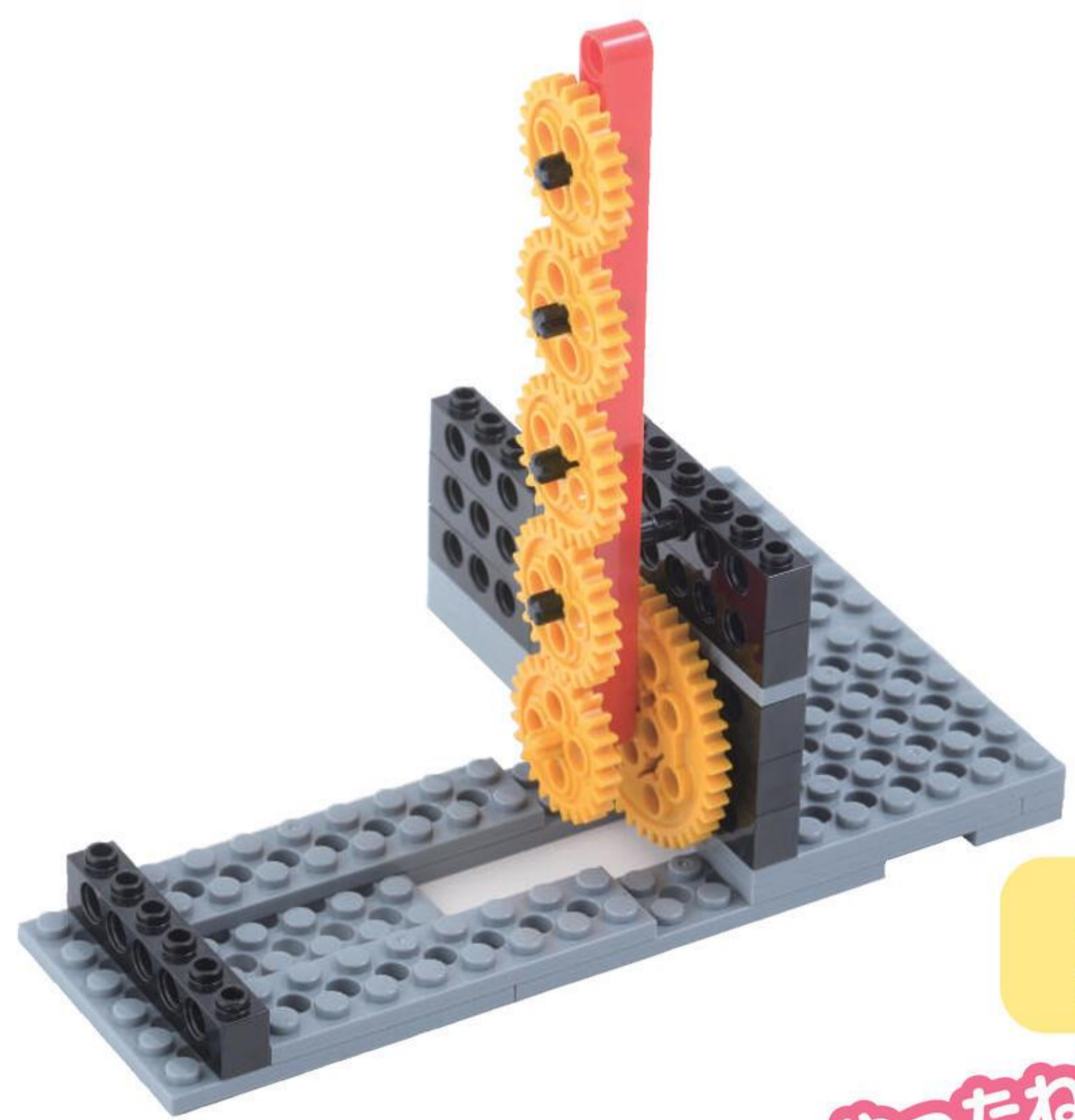
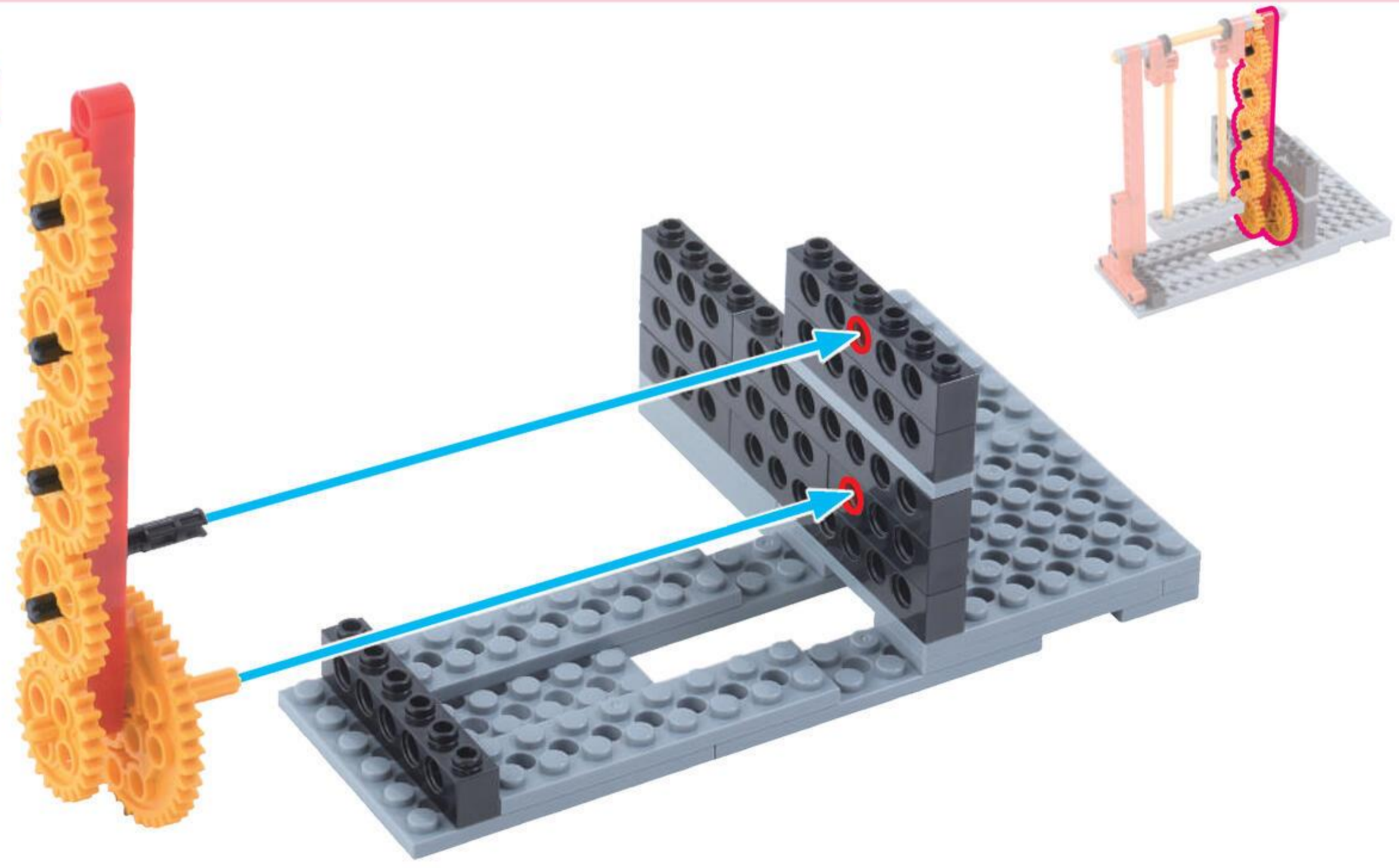

はしらが
かんせい!

やったね!

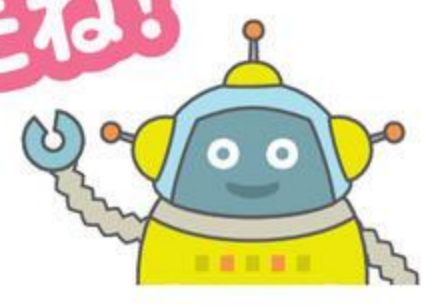

4

ブランコ

めやす 15ふん

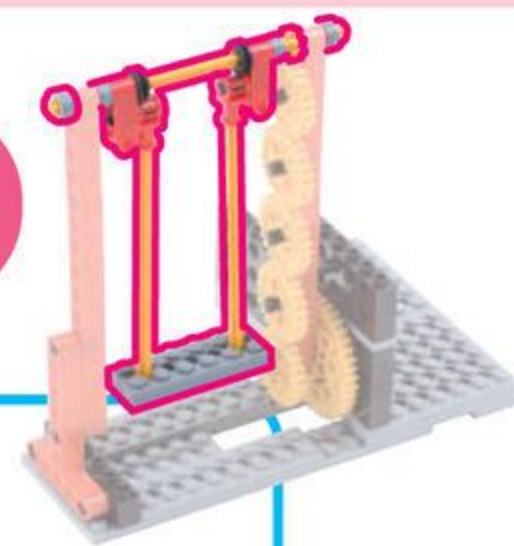

しゃふとじゆうに ぼち
シャフト 12 ポチ 2こ



ぶっしゅ
ブッシュ 2こ



1

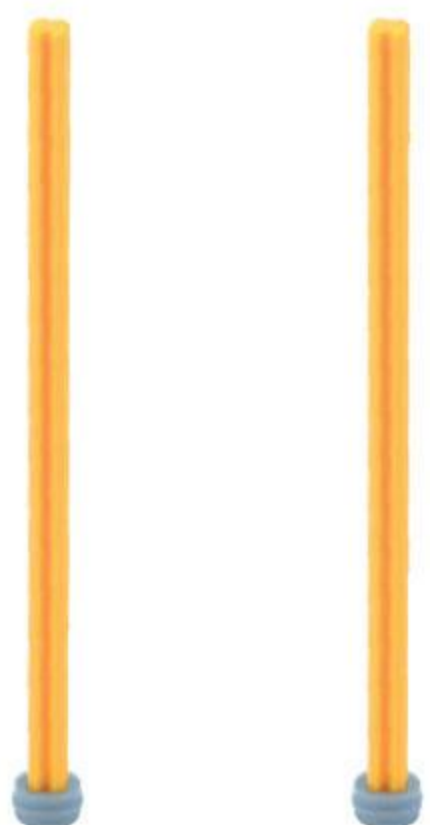
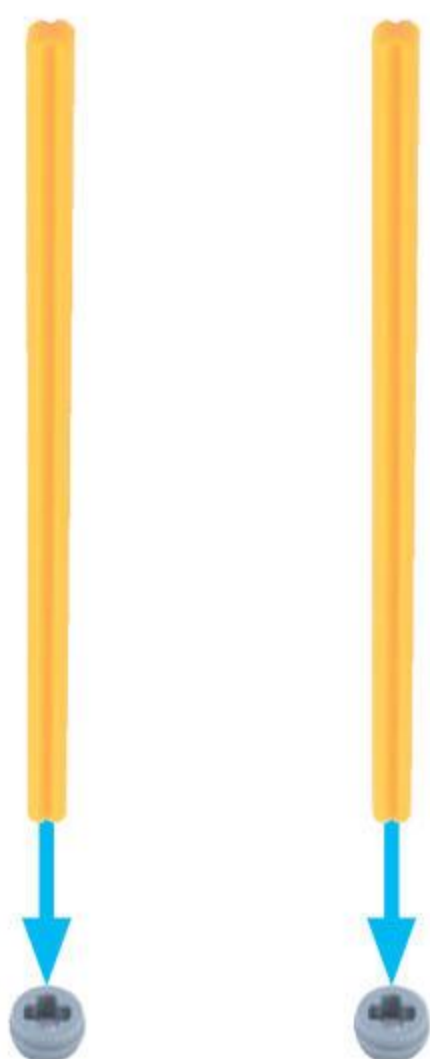

ふとぶれえとろくほち
太プレート6ポチ 2こ

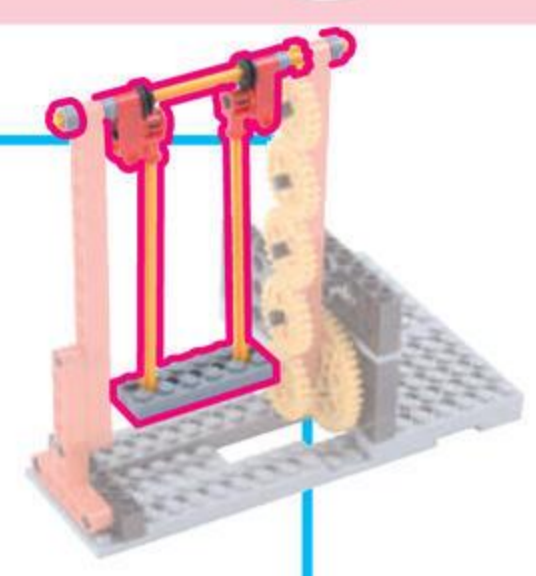

2

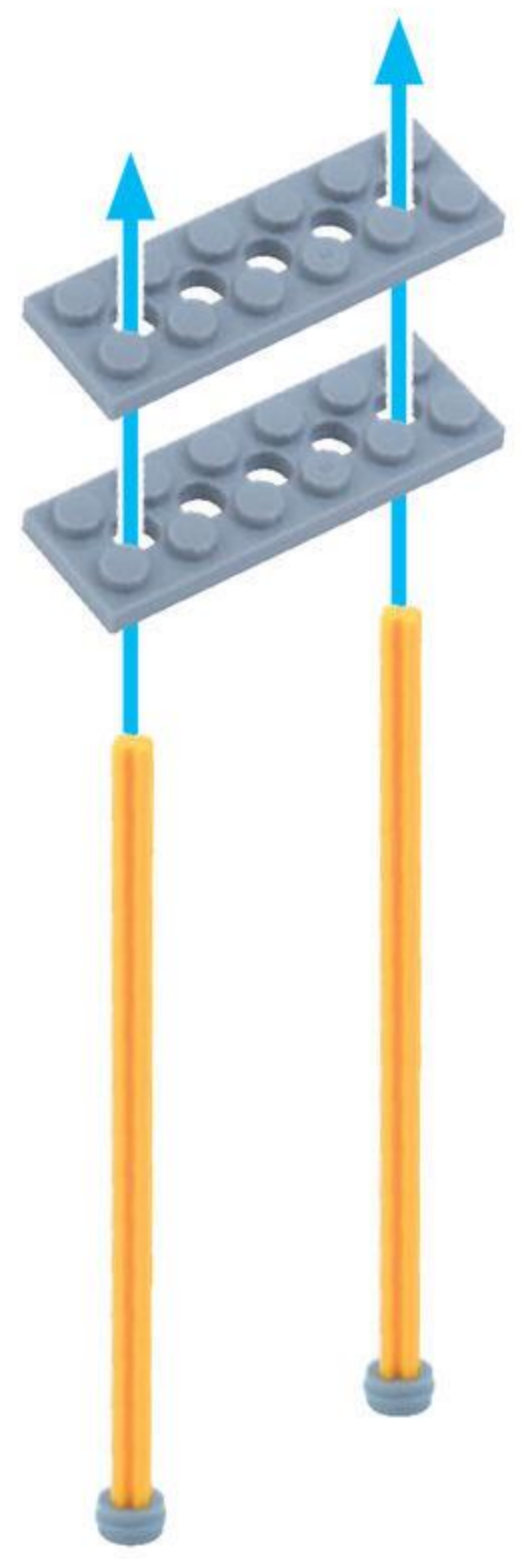

ていじょいんと
T ジョイント 2こ

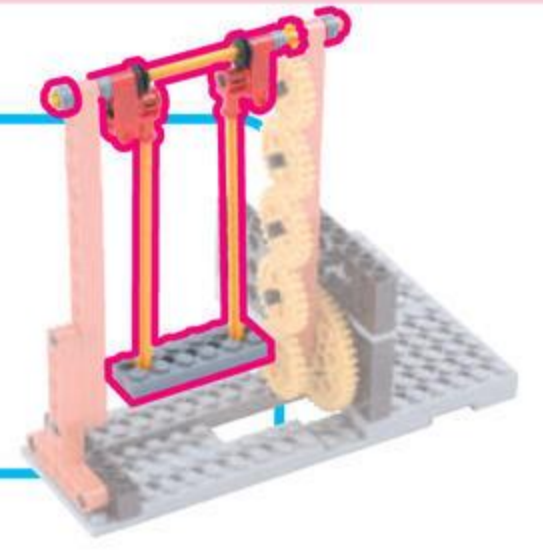

3

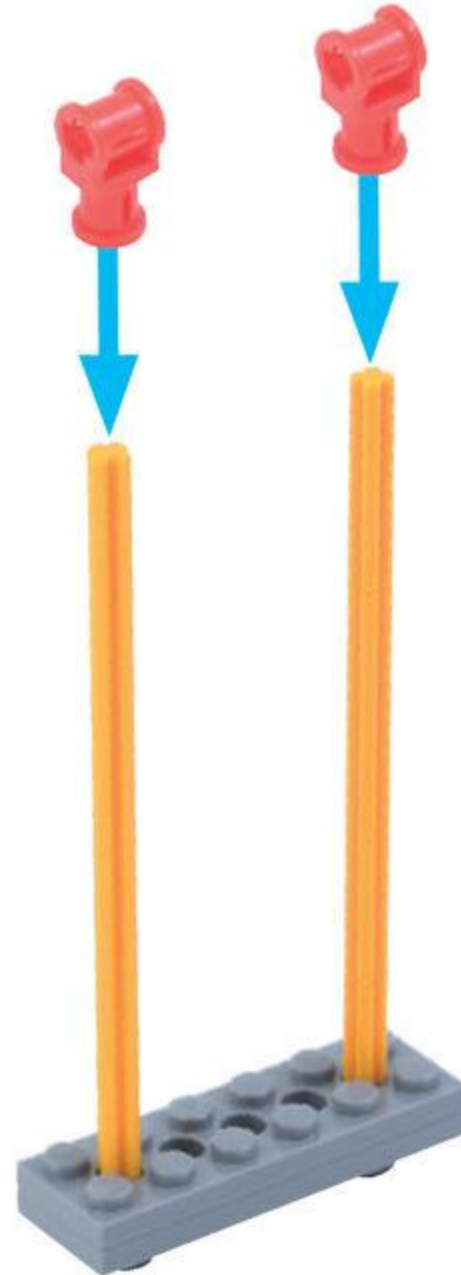

くろすじょいんと
クロスジョイント 2こ



しゃふとペグ
シャフトペグ 2こ

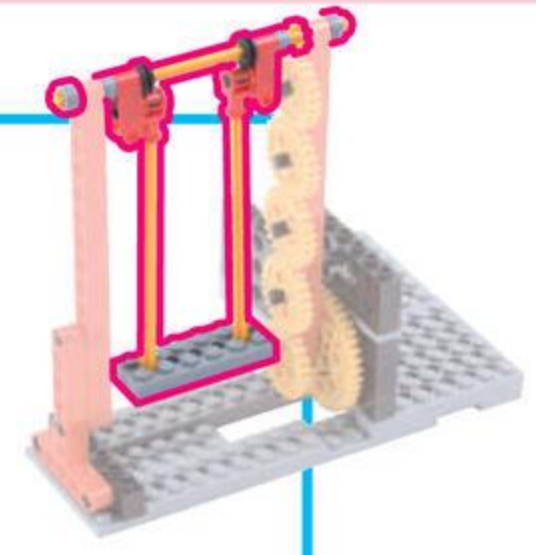

4



むきに ちゅうい



しゃふとじゅうほち
シャフト 12 ポチ 1こ



ぐろめつと
グロメット 2こ

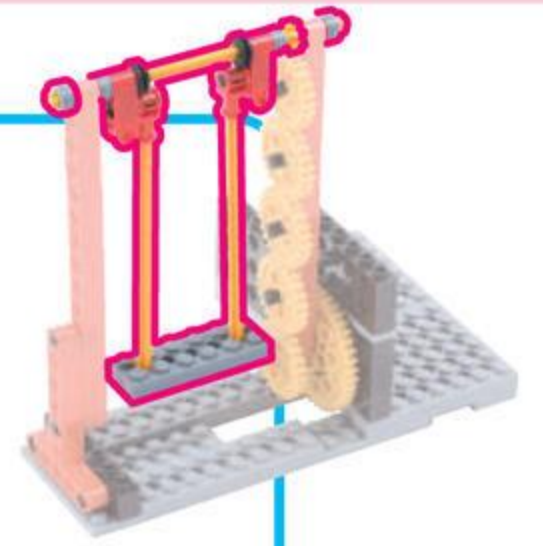

5



ぶっしゅ
ブッシュ 2こ



びにおんぎあ
ピニオンギアうす 1こ

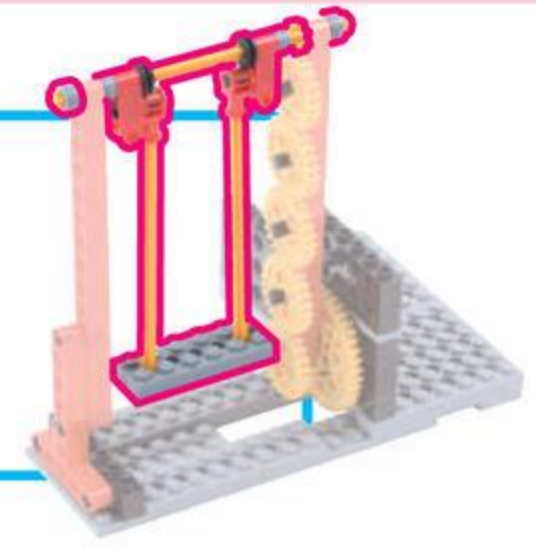

6

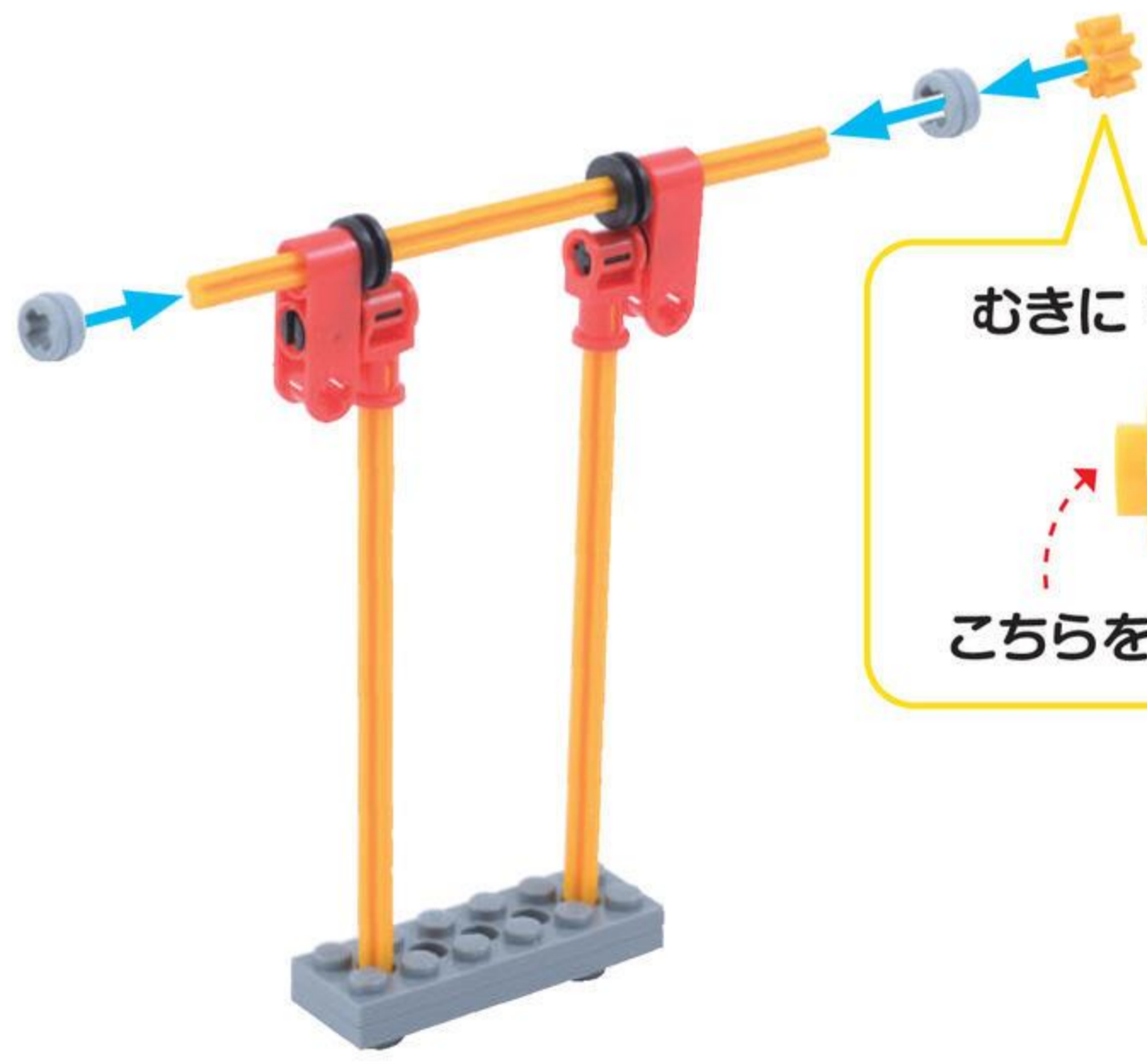

むきに ちゅうい
こちらを さしこむ



ぶっしゅ
ブッシュ 1こ

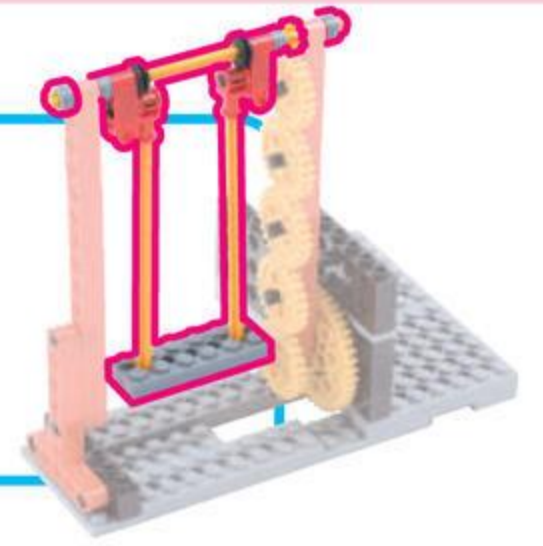

7

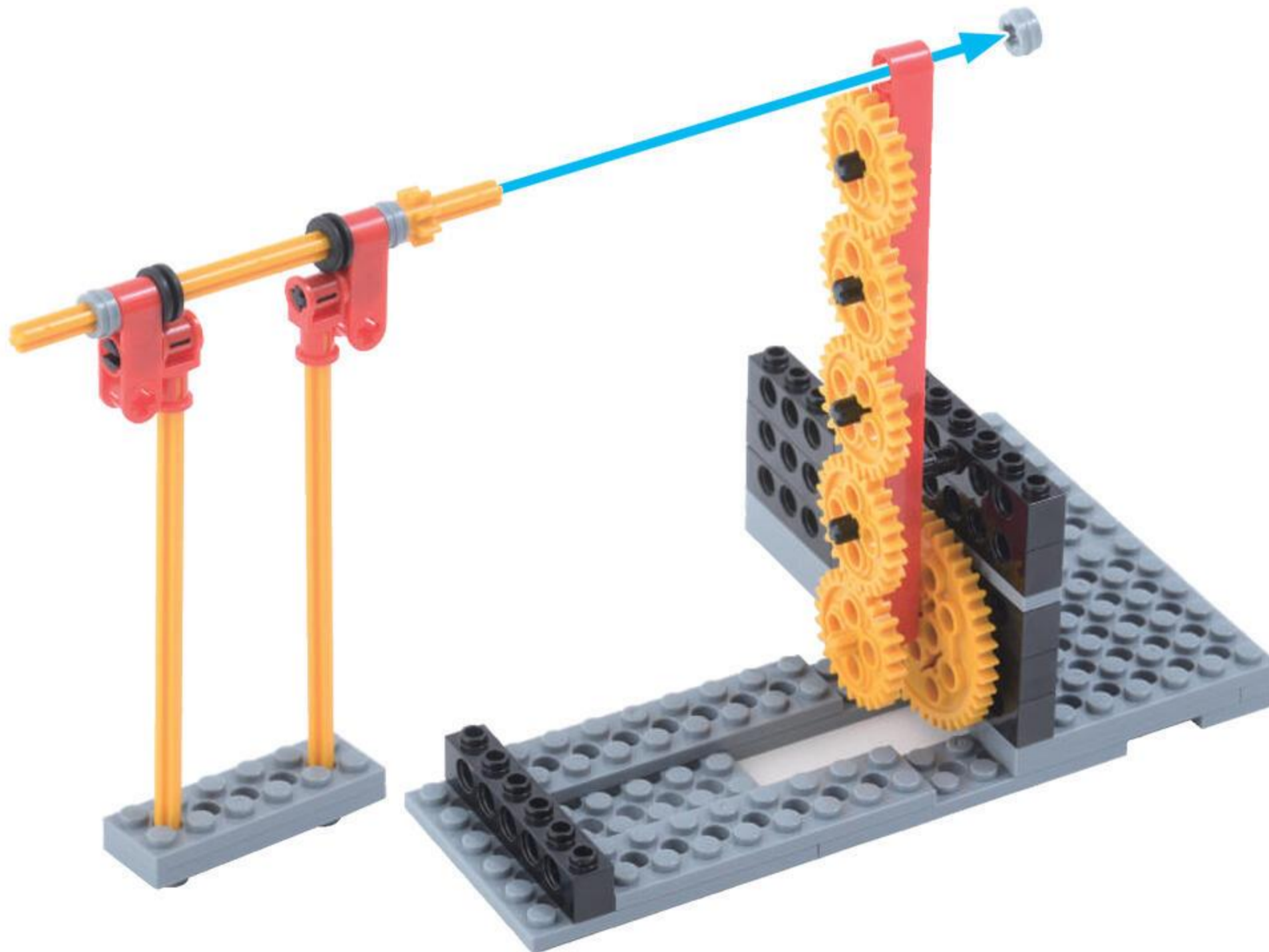

しっかり かみあわせよう

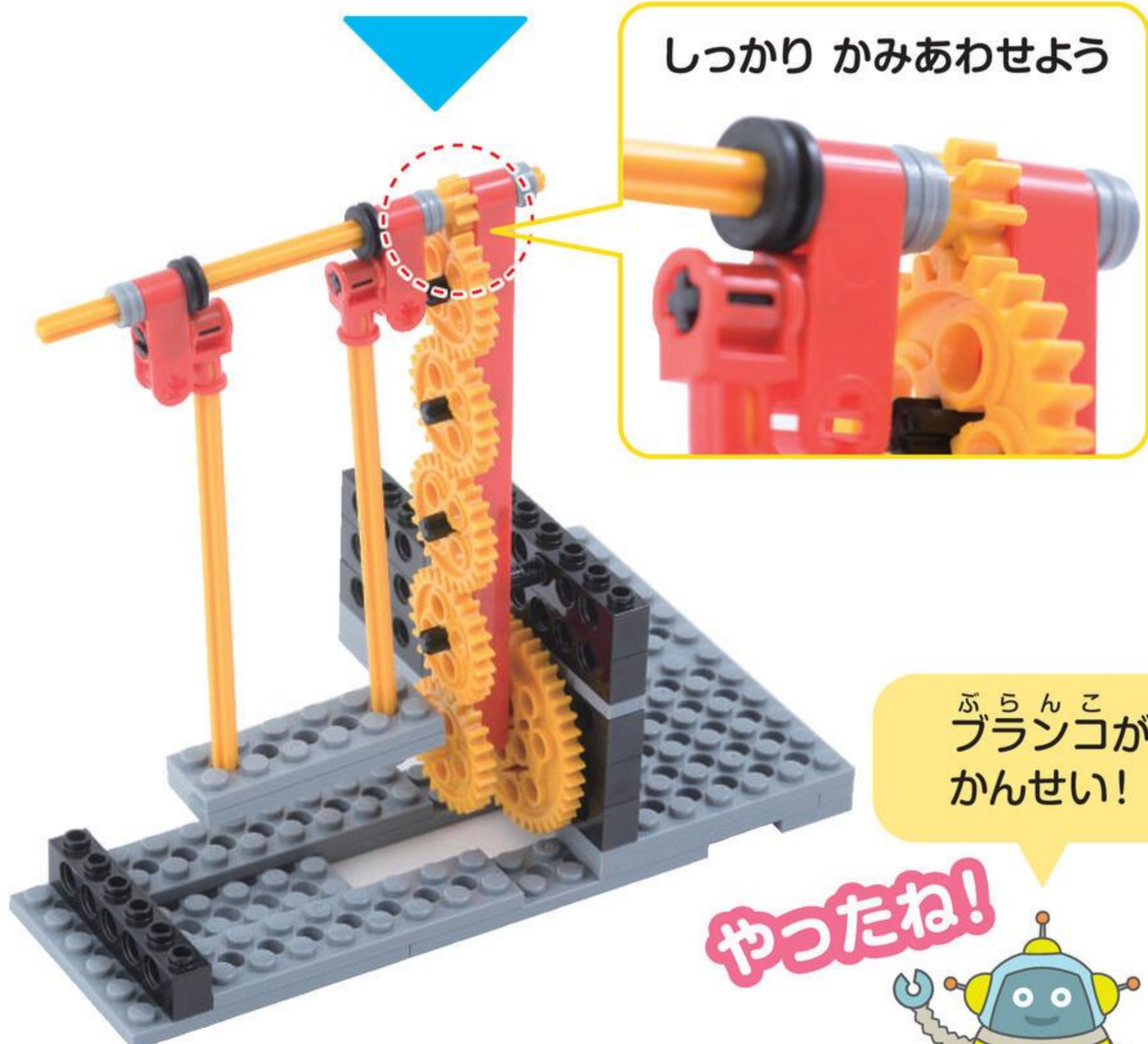

ぶらんこ
ブランコが
かんせい!

やったね!

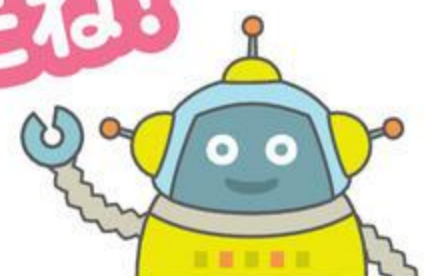

5 もう1つのはしら めやす 5 ぶん

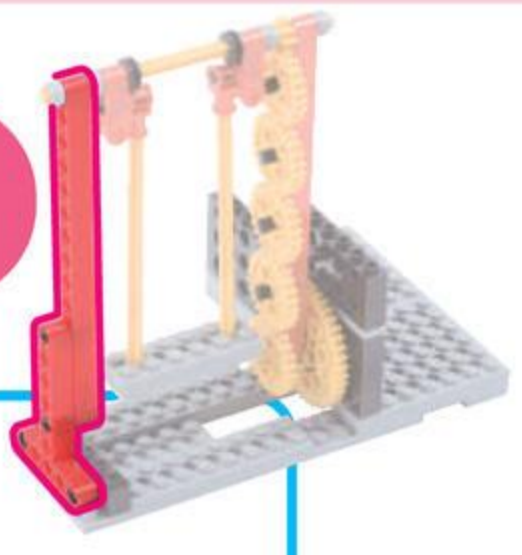

てい るっど T ロッド 1こ

ぺぐ えす S 4こ

1

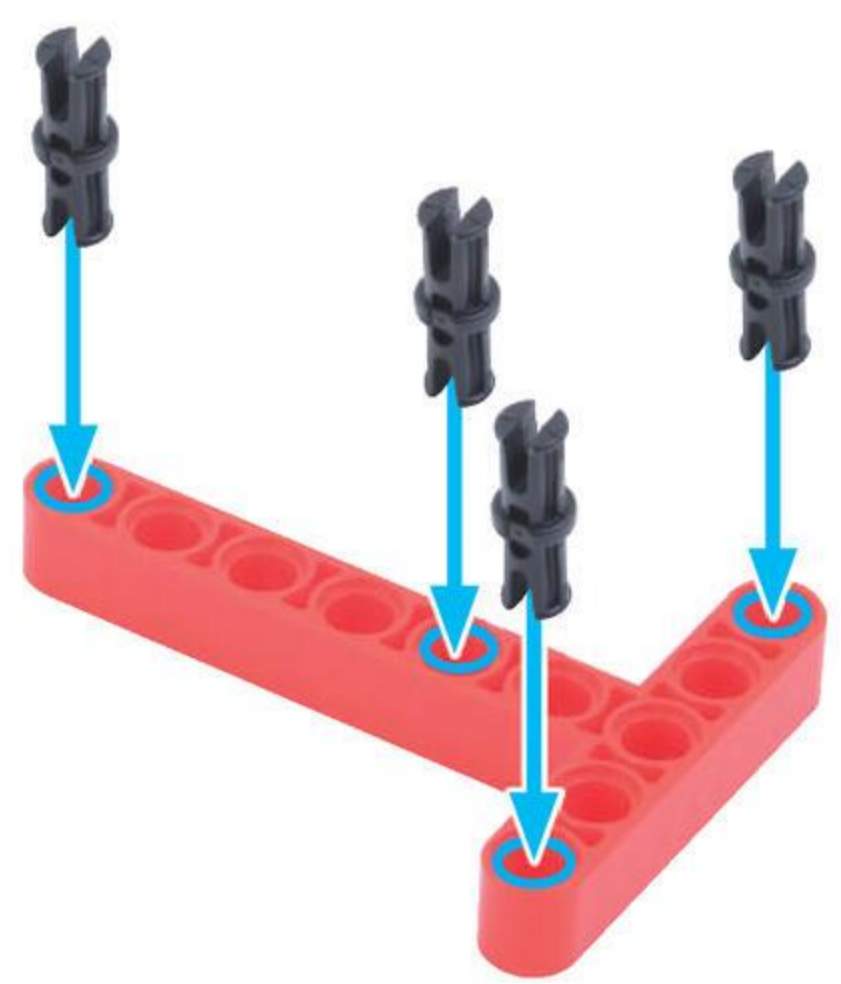

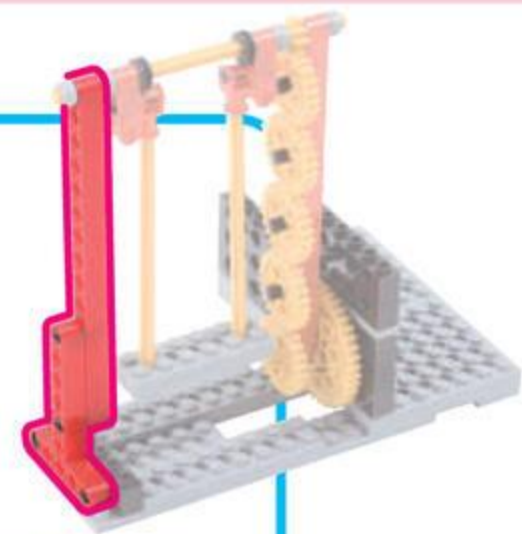

ろっど 15 アナ 1こ



2

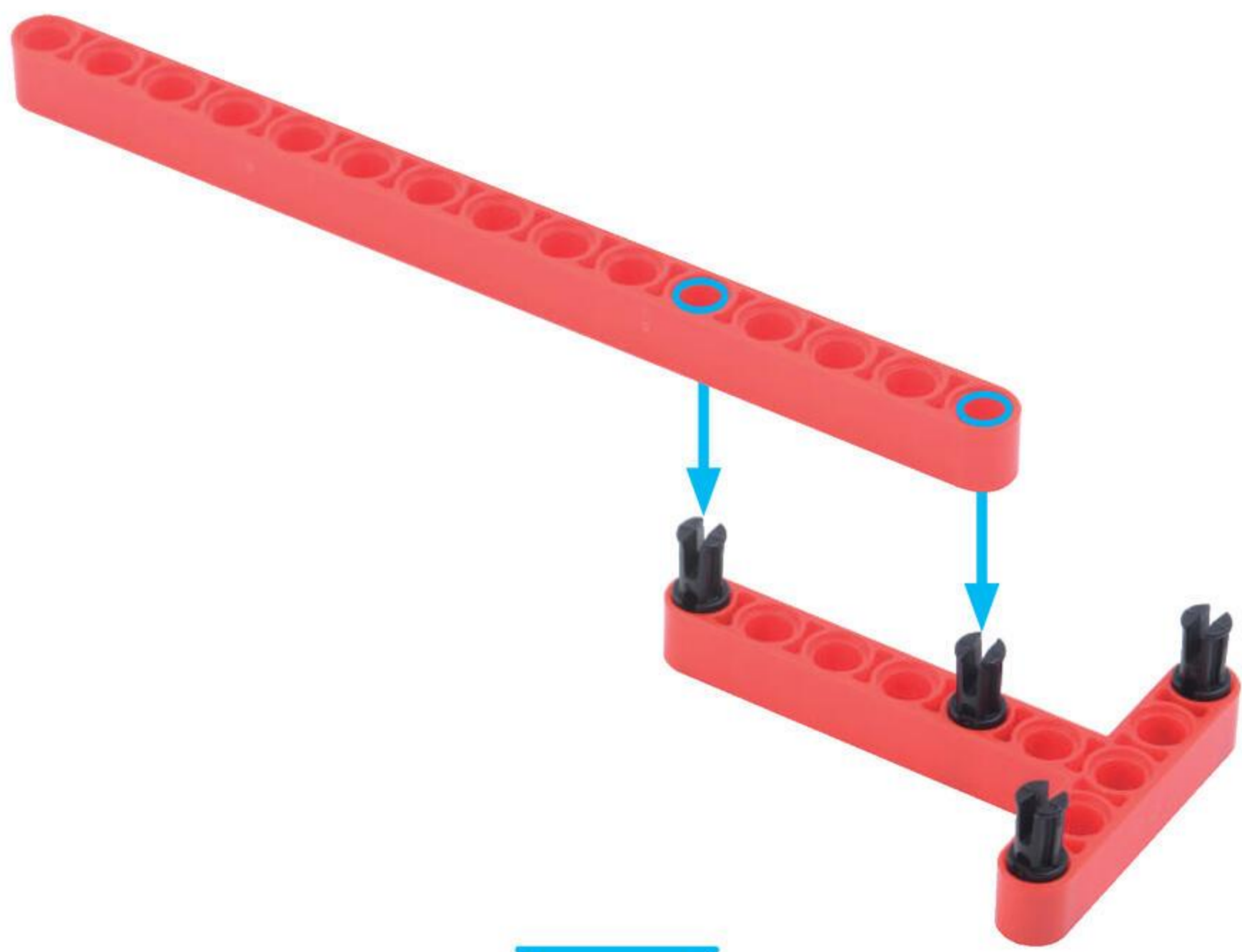

ぶっしゅ
ブッシュ 1こ

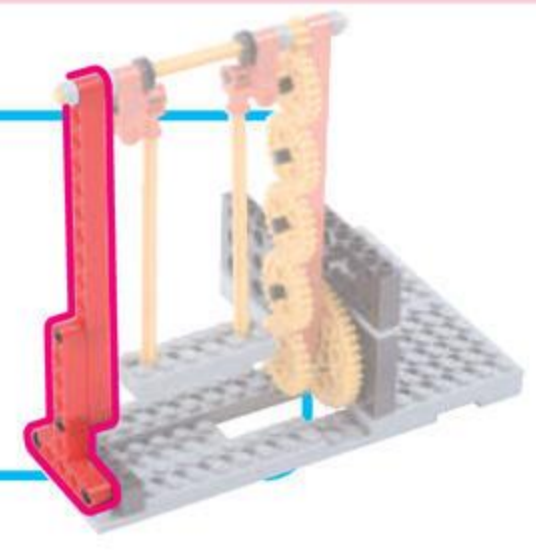

3

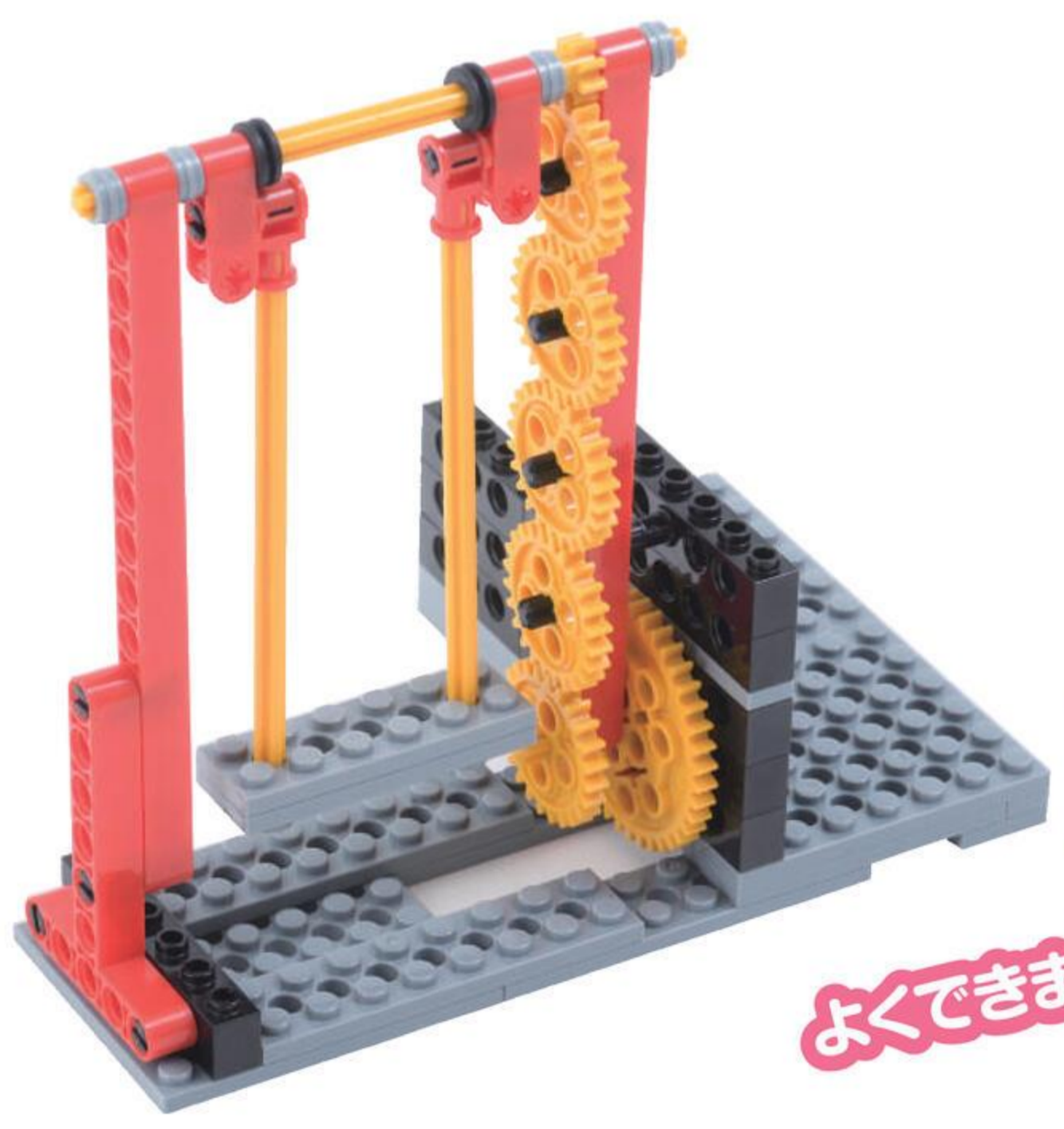
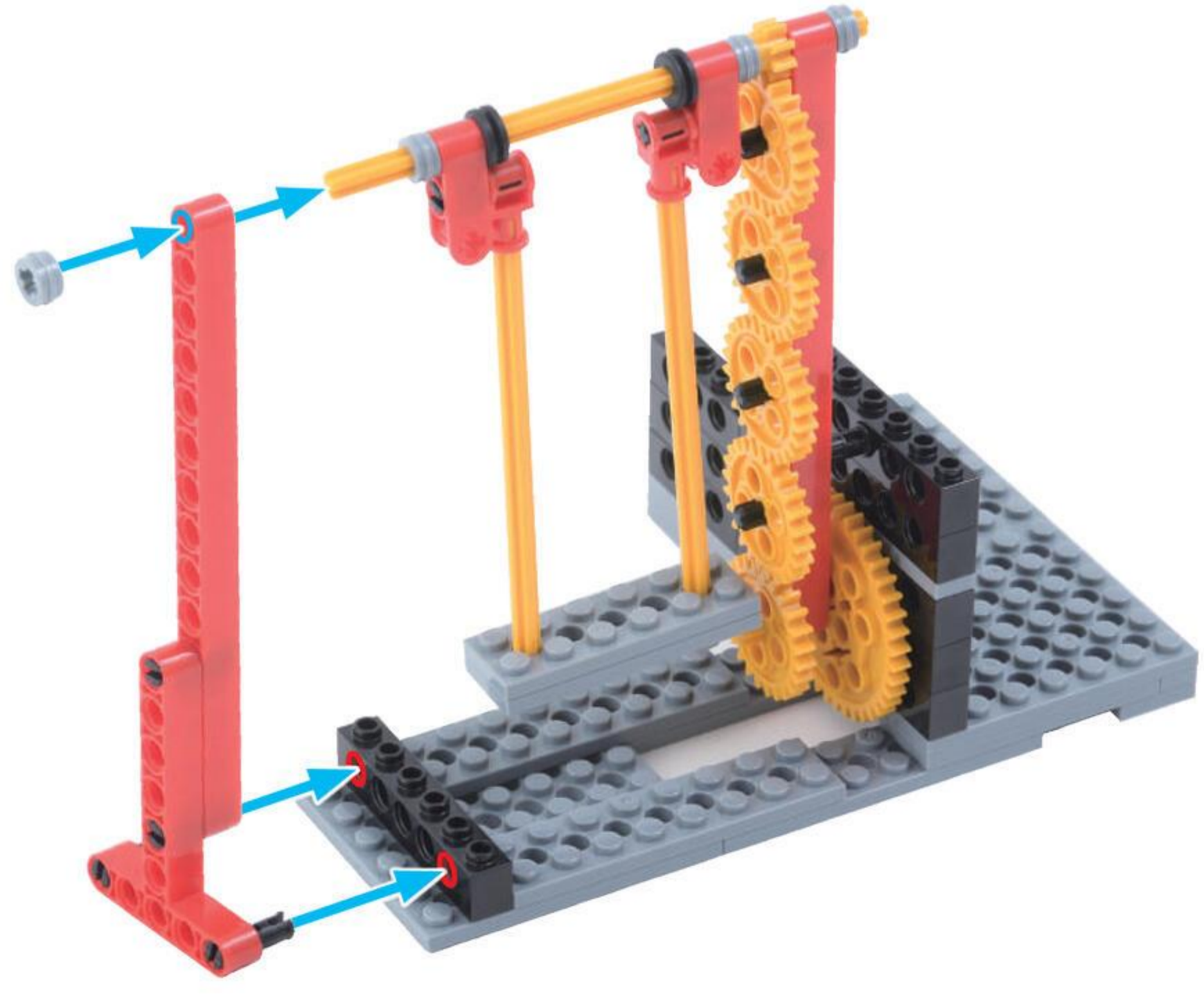

これで
かんせい!

よくできました!



ろぼっと
ロボットを うごかさう

めやす 10 ぶん

くらんく 1こ



1

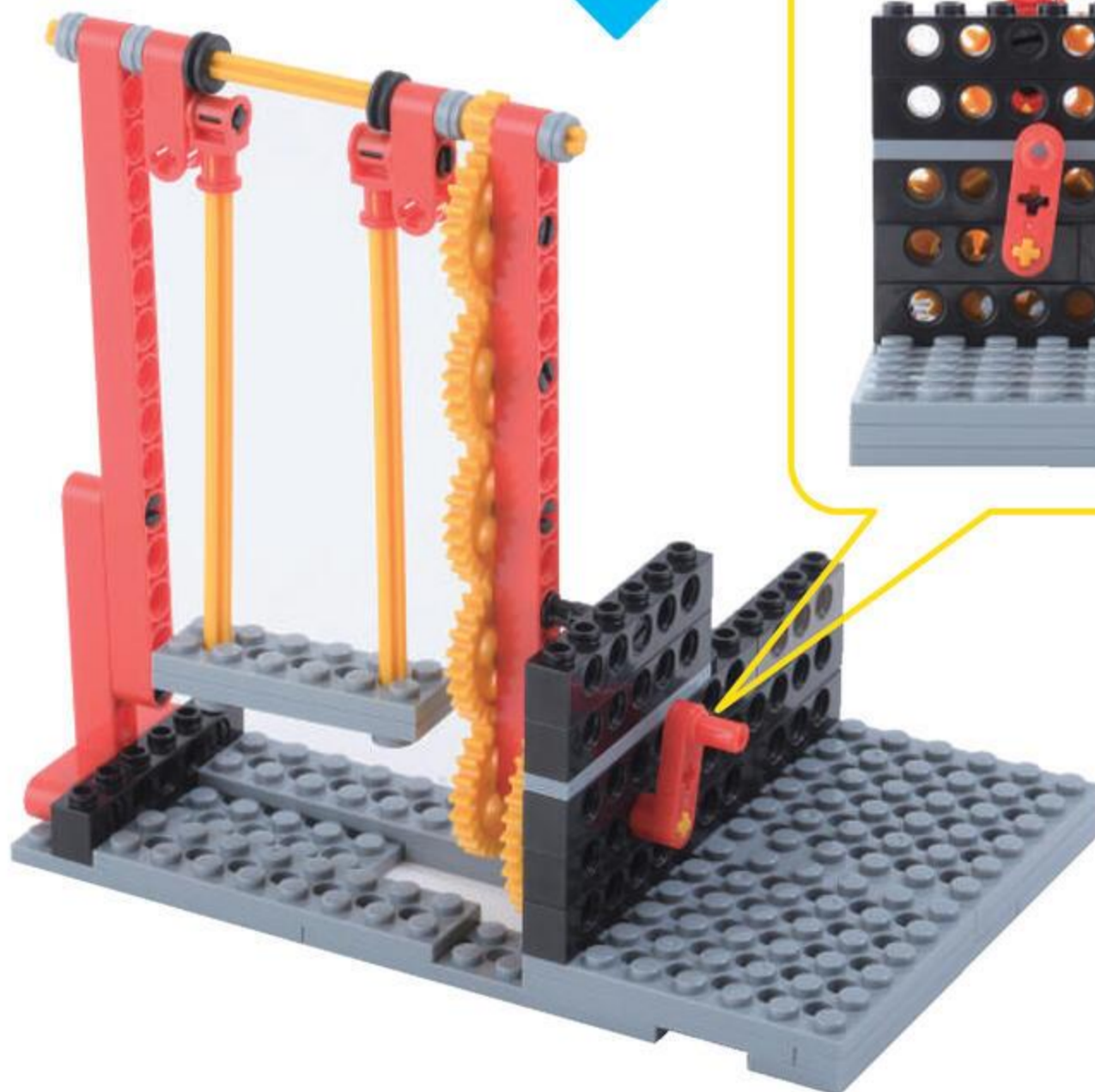
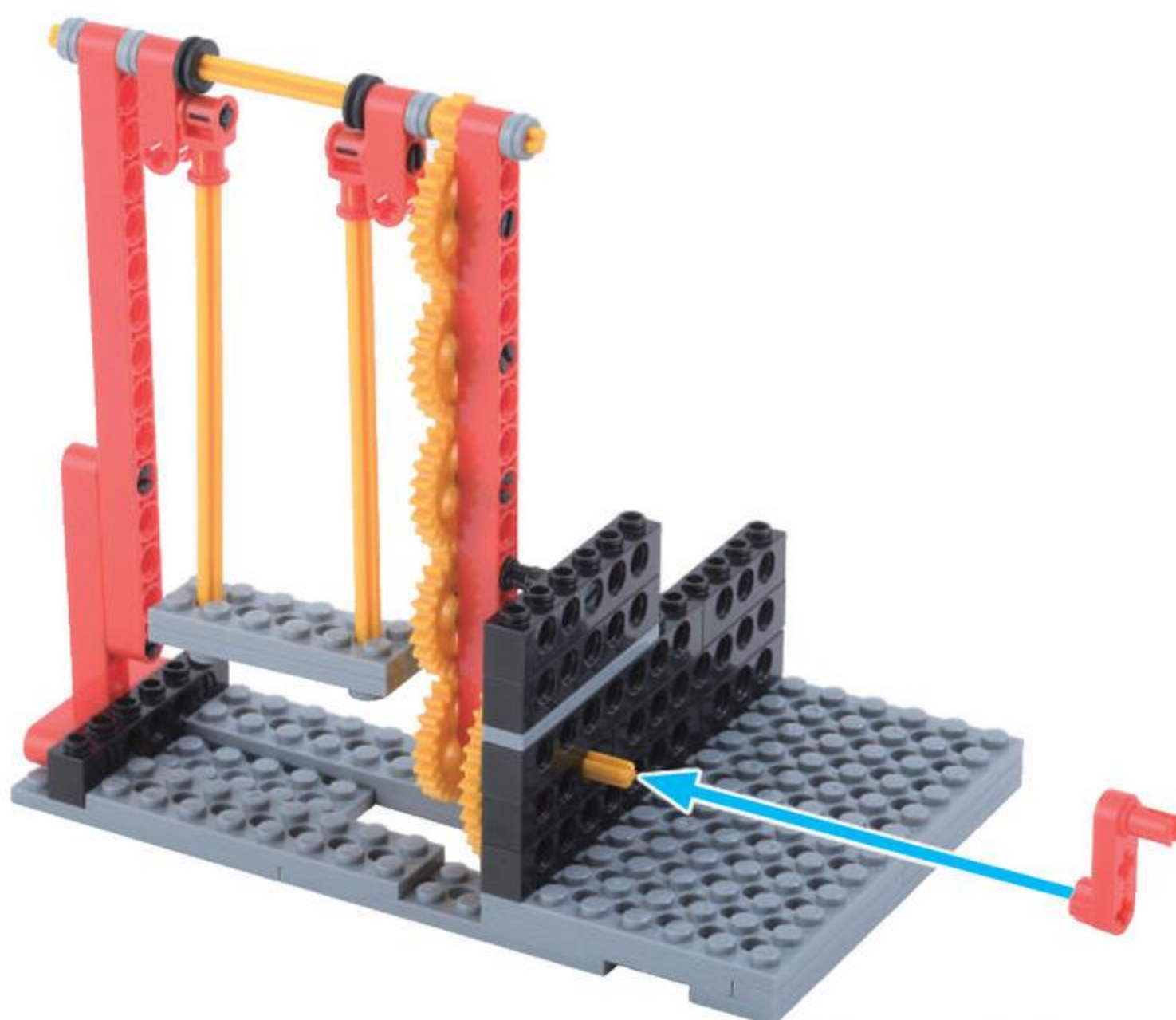

ぶらんこ
ブランコを てで
ささえながら
ぱいろっと
パイロットを
のせよう

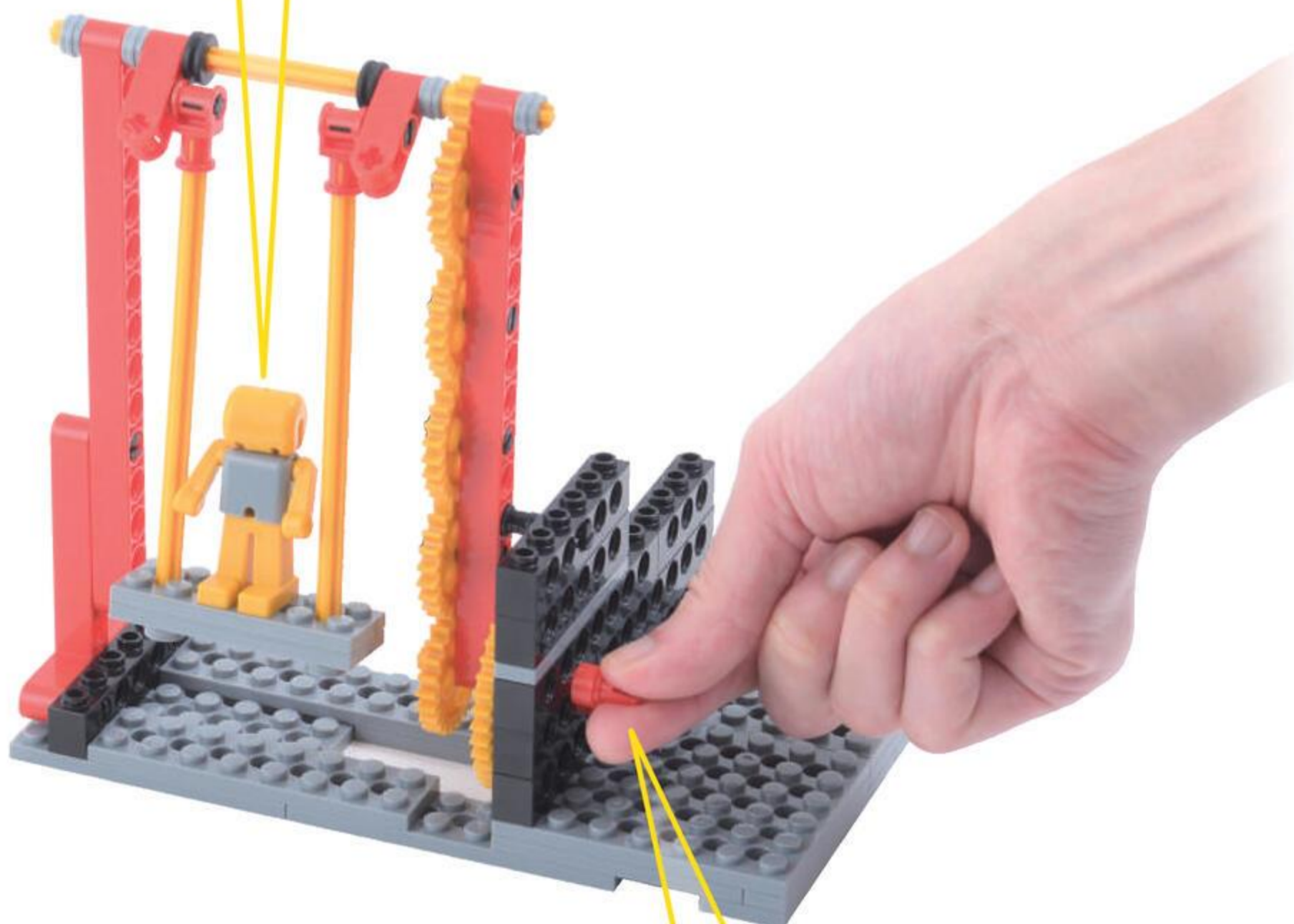

やじるしの ように
くらんく
クランクを うごかそう

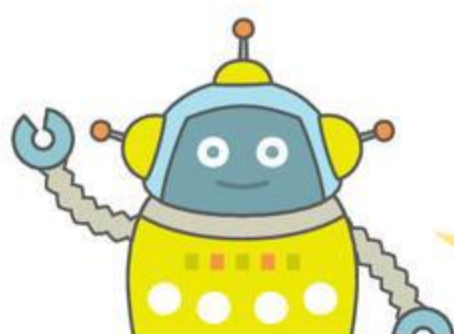
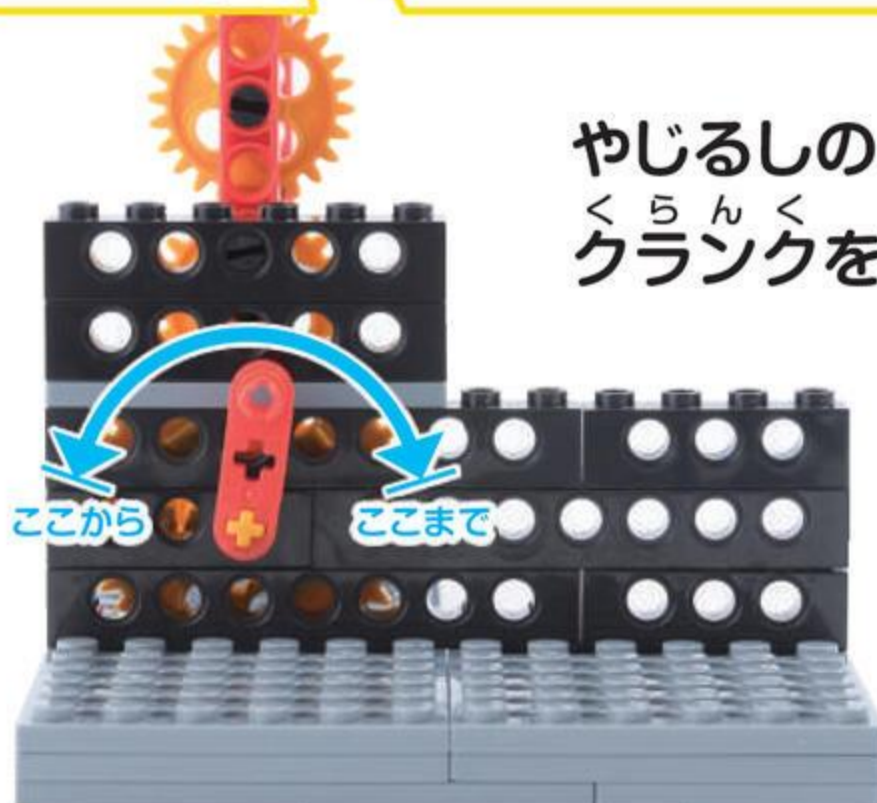

じかいは ^{も お た あ} モーターで うごくように
かいぞう してい くよ

Q1 ^{てい}ジョイントをさがそう! どれかな? ^{どれかに}

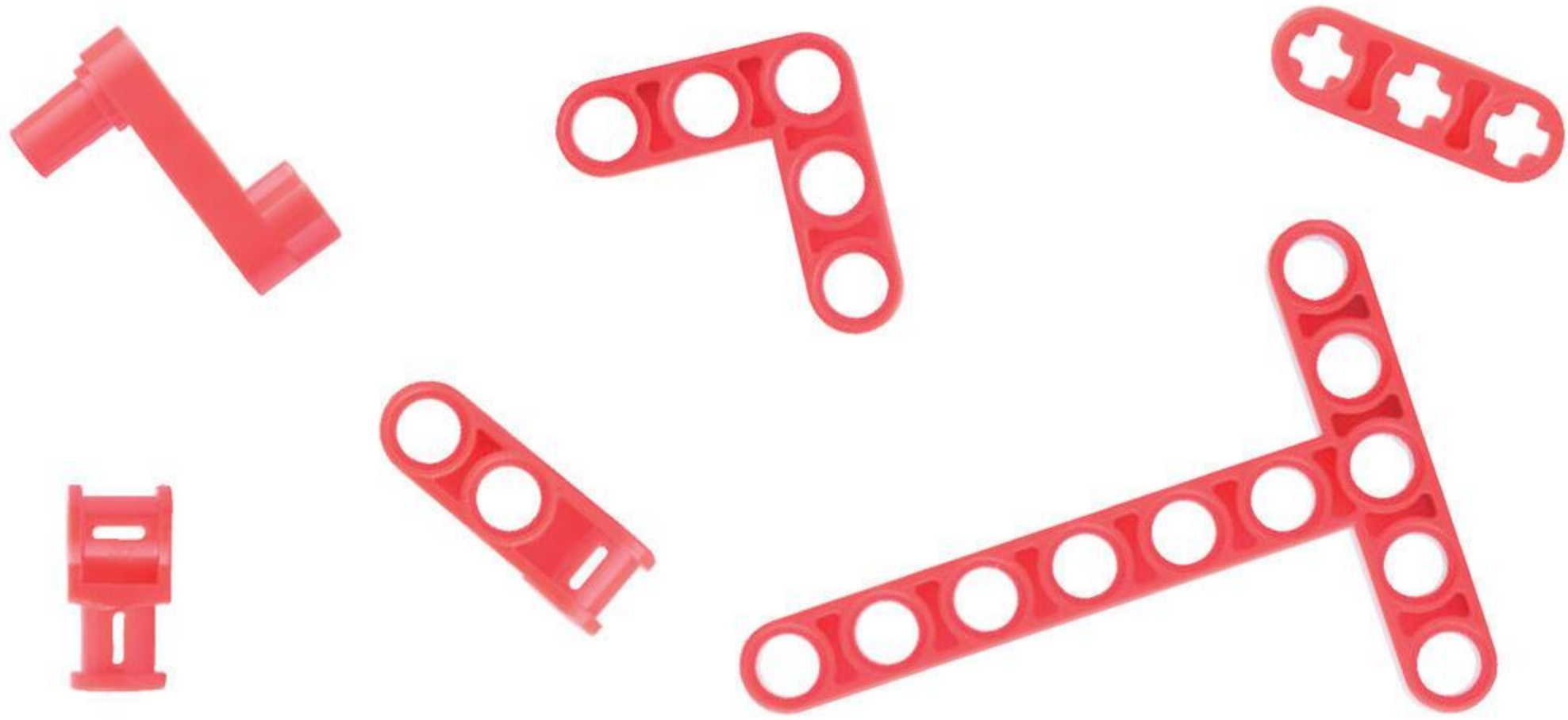

Q2 ^{くろす}ジョイントには ^{ペグ}S をなんことりつけられるかな?



ペグ S

(1 こ ・ 2 こ ・ 3 こ) ^{どれかに}

Q3 ^{くろす}ジョイントには ^{シャフト}ペグ をなんことりつけられるかな?



シャフトペグ

(1 こ ・ 2 こ ・ 3 こ) ^{どれかに}



Human

ヒューマンアカデミー ジュニア
STEAMスクール



ロボット教室

ロボットのきょうかしよ

プレプライマリーコース 回

2

ぶらんこロボ「ゆらりん」



★だい2かい

2024ねん

11がつ

にち

なまえ

もくじ

だい 2 かい

きょうの よてい	39	2ふん
くみたて		
1. ギアボックス	40~57	
ロボットを うごかそう	58	
くみたて		
2. あたらしい じめん	59~62	80ふん
3. あたらしい ブラシ	63~67	
4. あたらしい はしら	68~70	
ロボットを うごかそう	71	
じゆうに かいぞう してみよう	72	
まちがい さがし	73	3ふん
かたづけ		5ふん

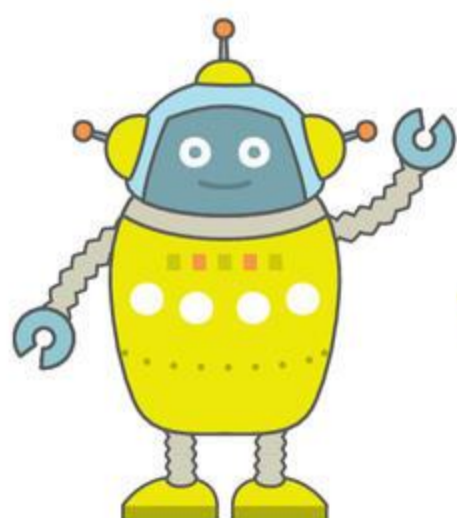
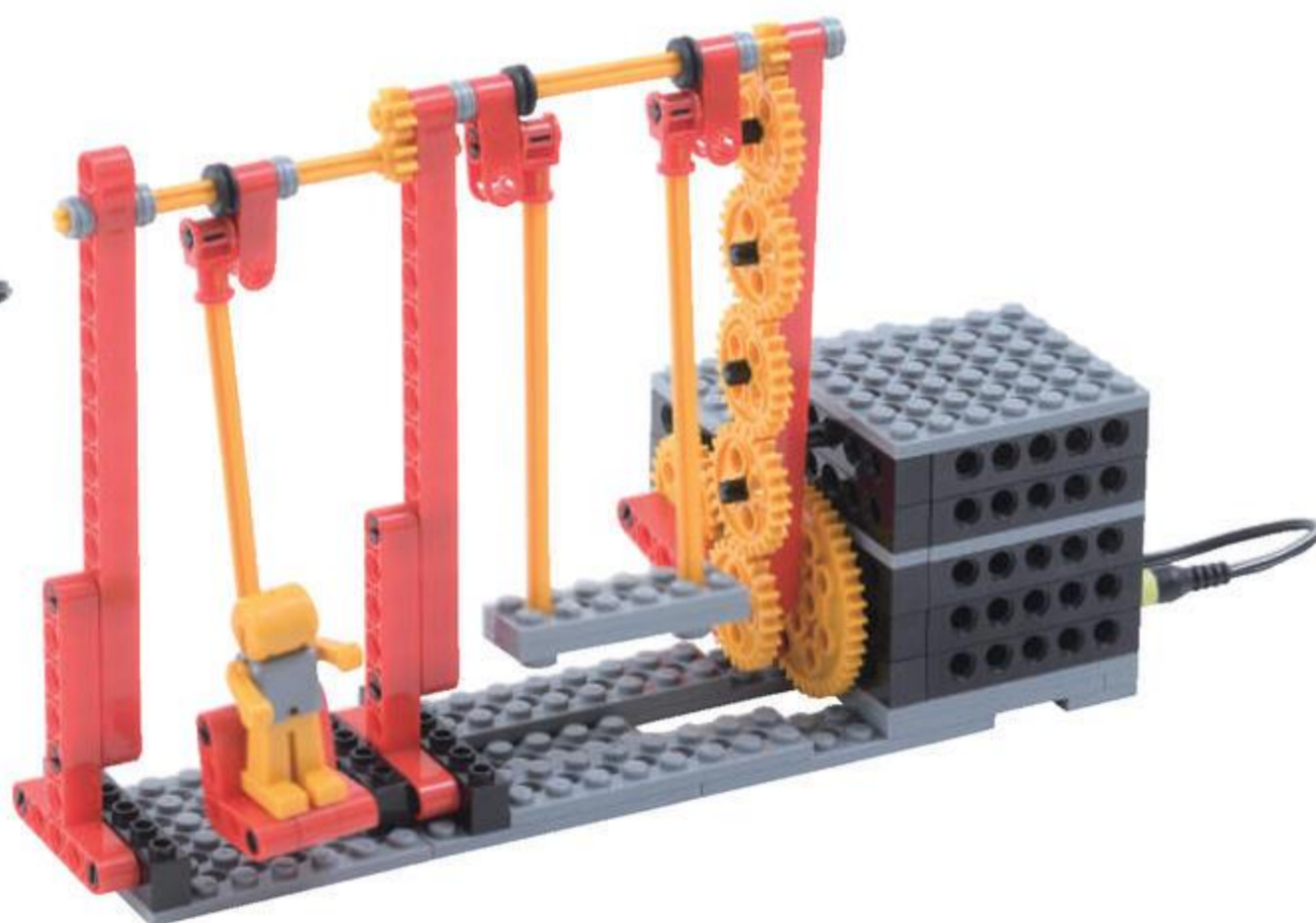

こんかいは ^{も お た あ} モーターで
 ロボットを うごかすよ

きょうの よてい

めやす 2 ふん

このじゅんばんでつくるよ!

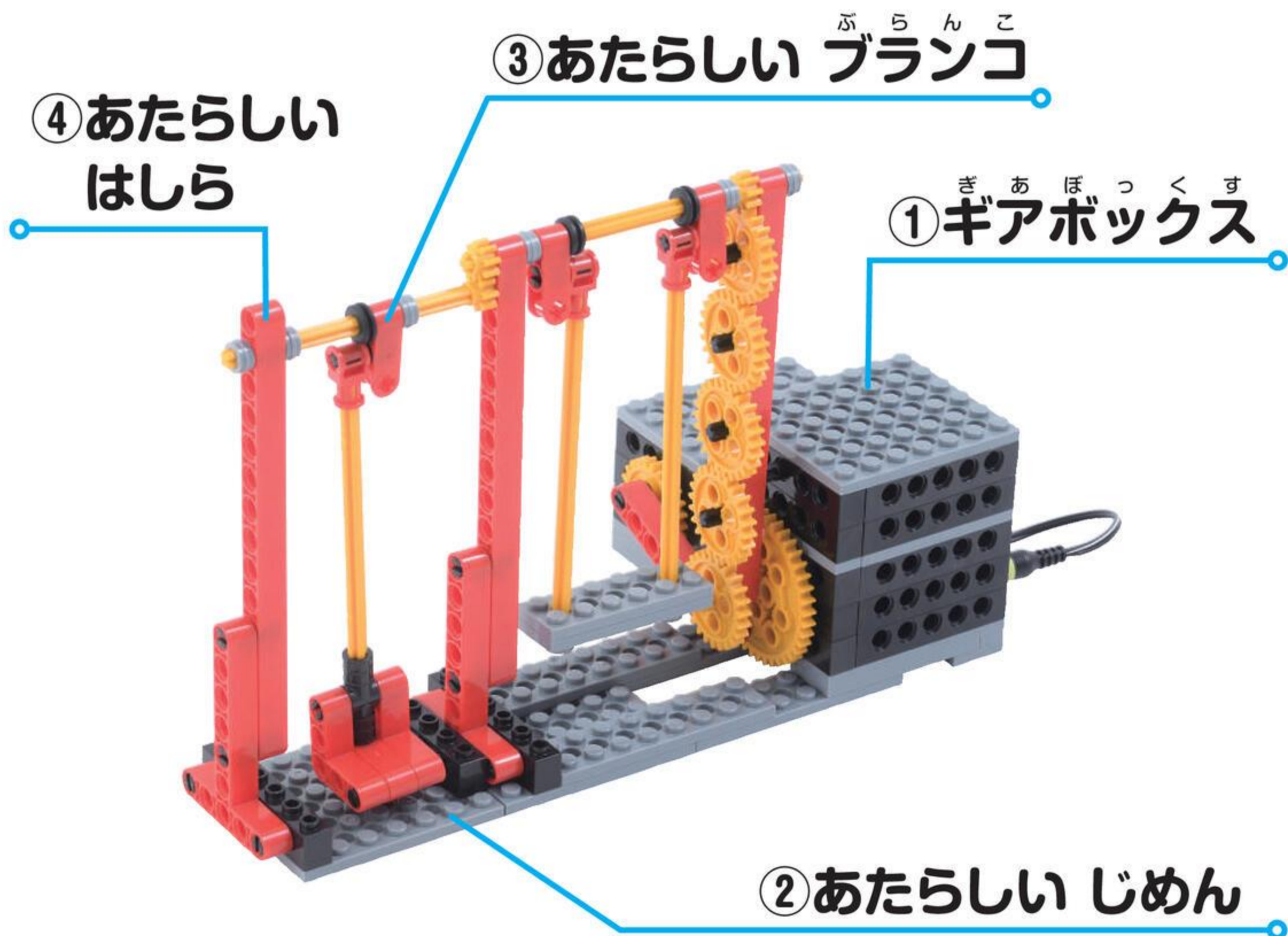

①ギアボックス

②あたらしいじめん

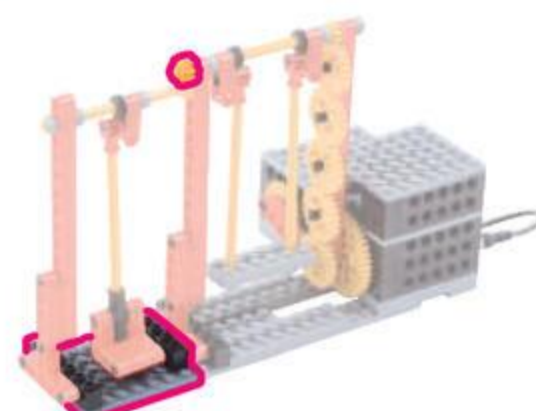
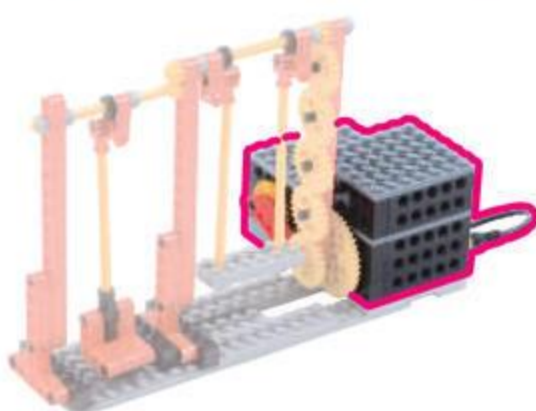

③あたらしいブランコ

④あたらしいはしら

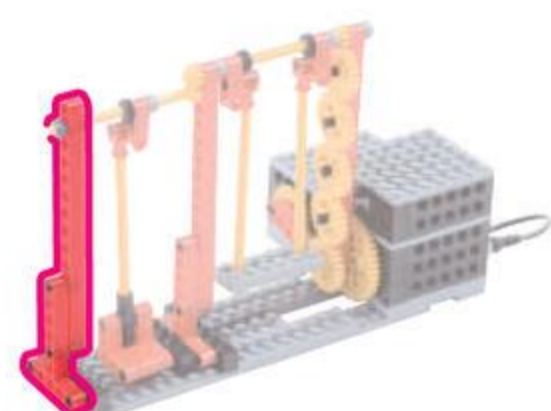
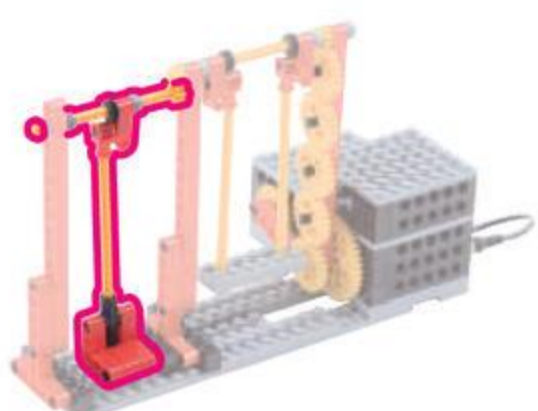

1

ギアボックス

めやす 25 ぶん

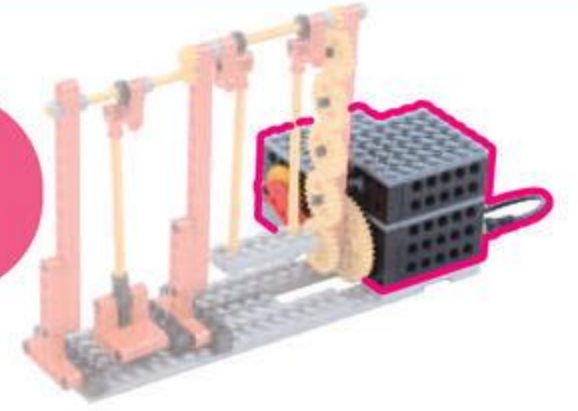

1

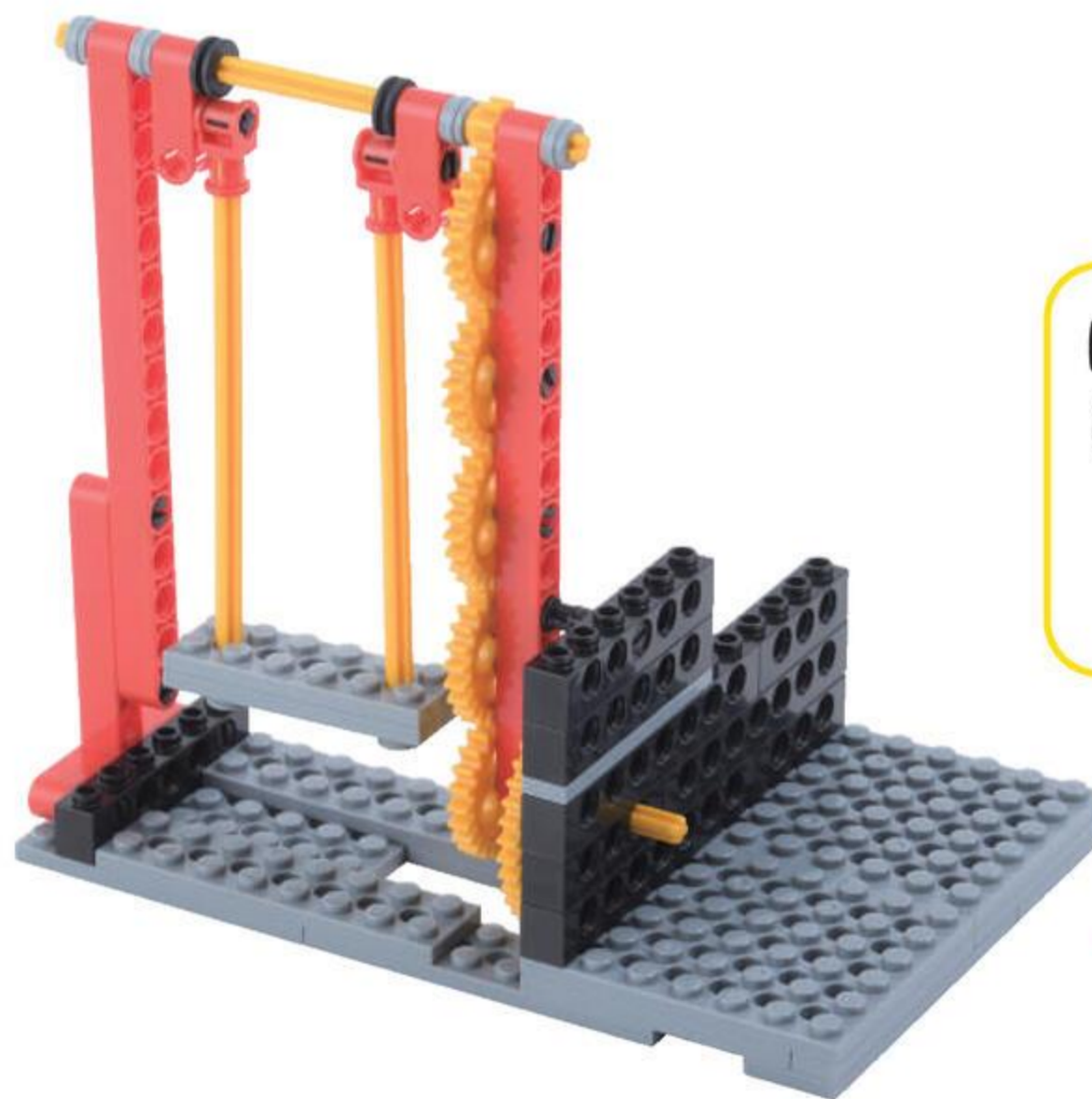
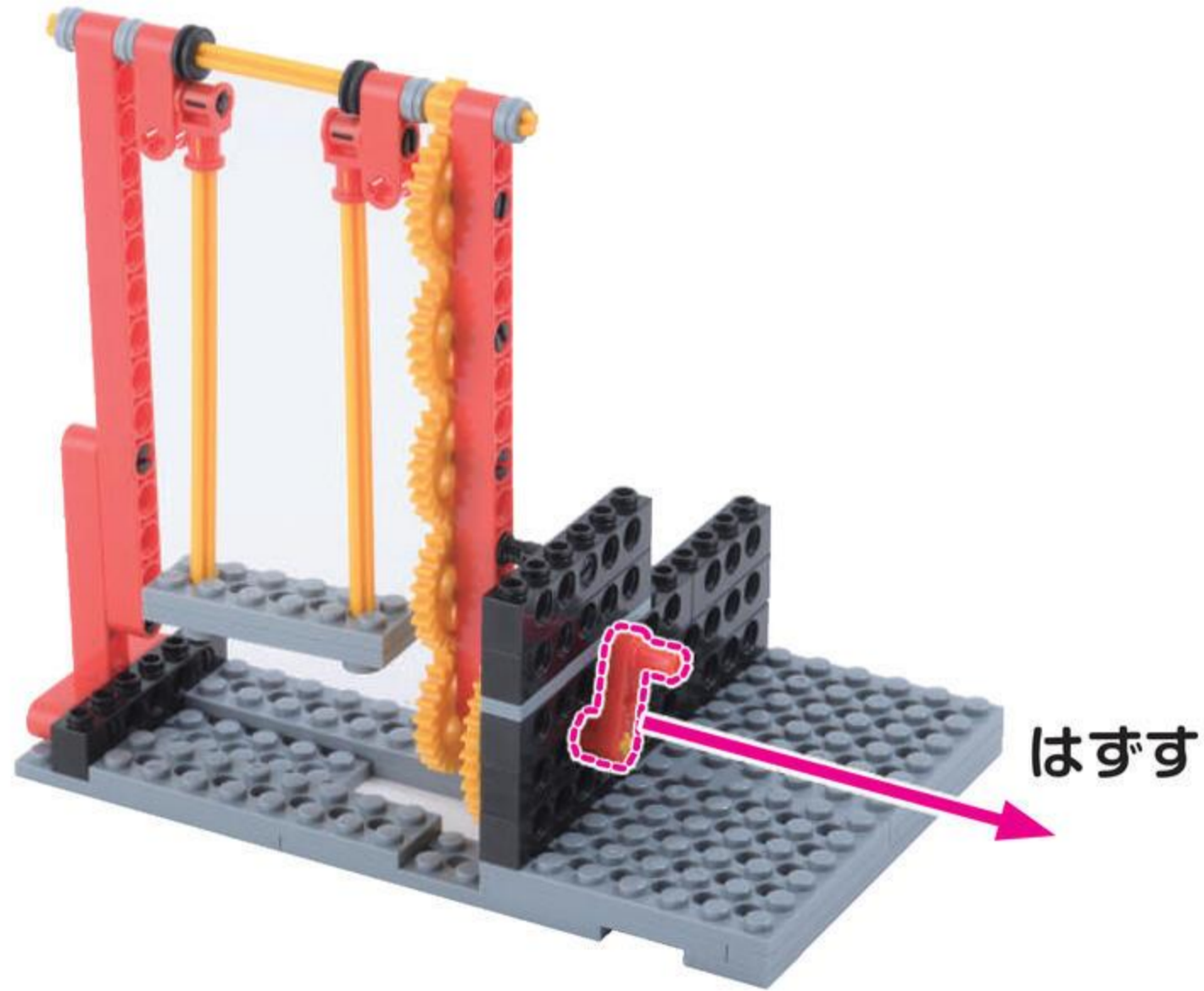

2

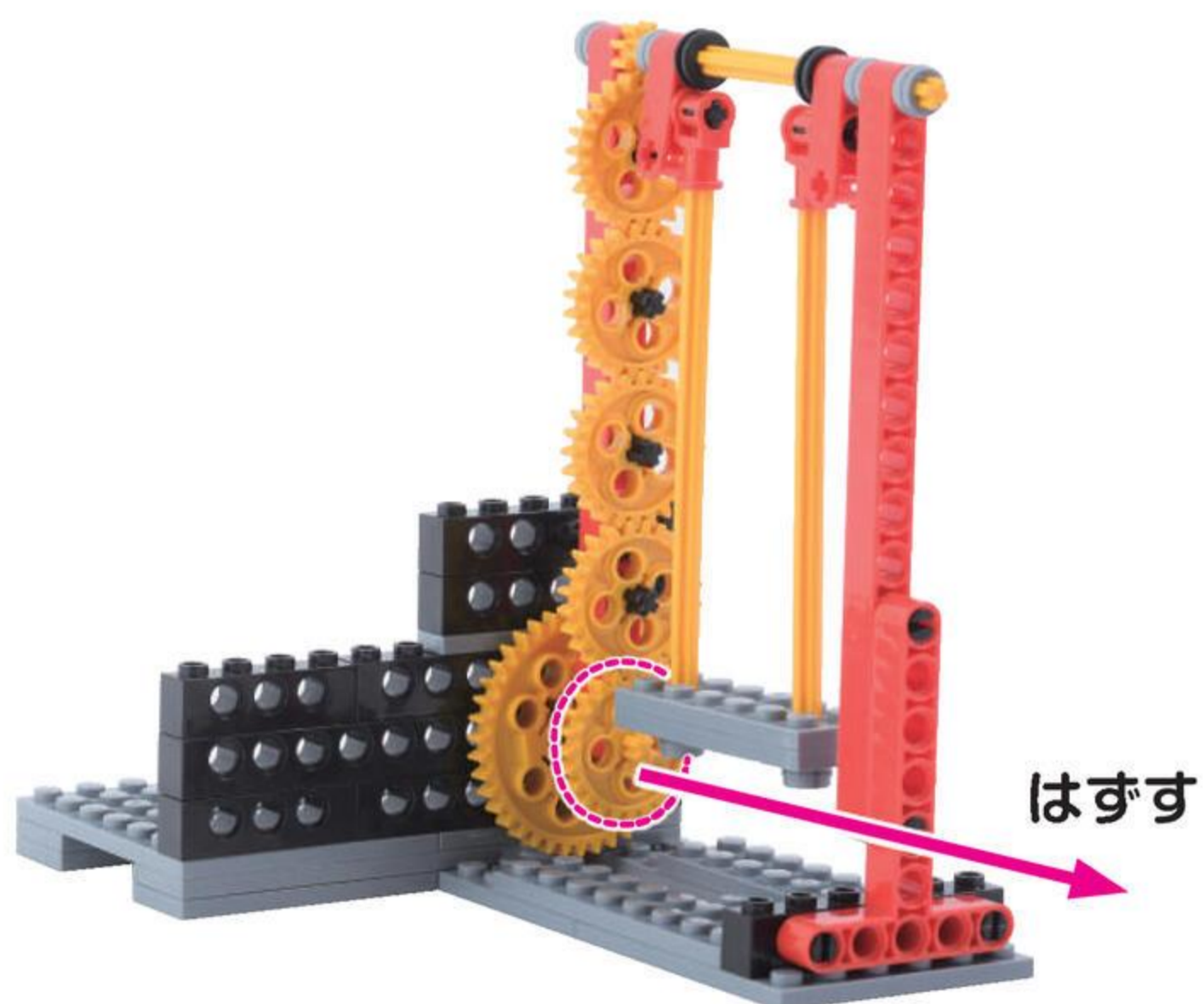
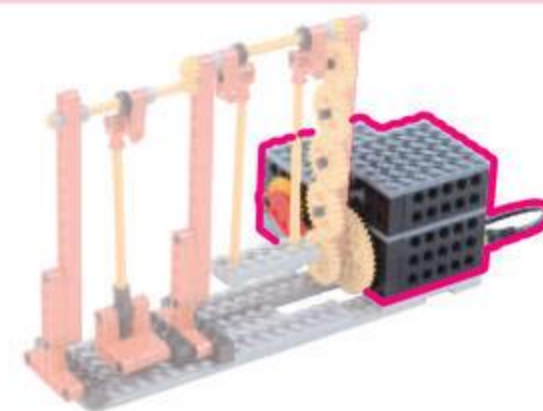

ぎあえむ
ギア M 1こ

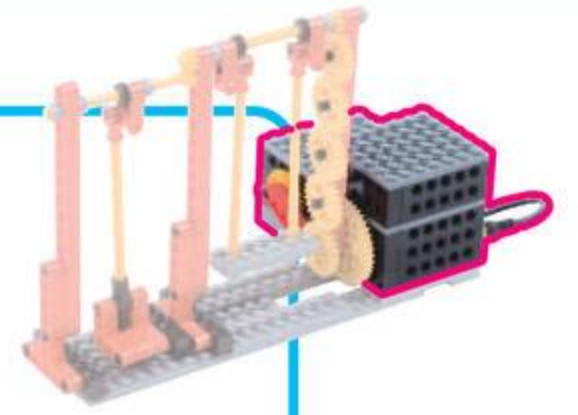
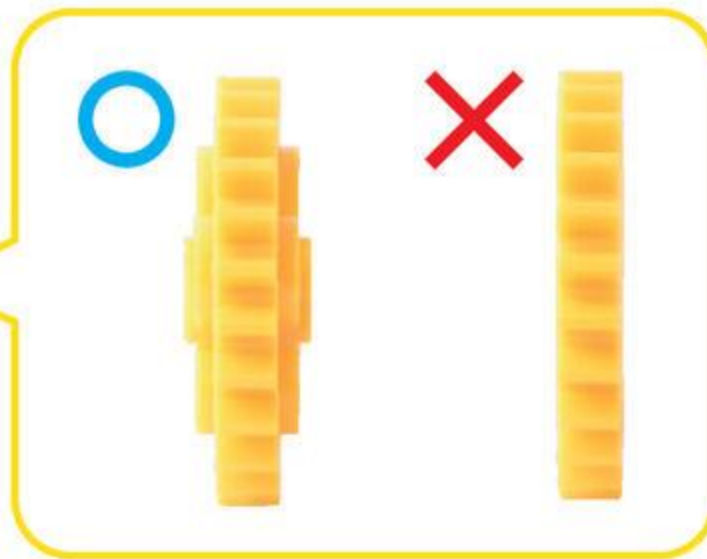

しゃふとさほち
シャフト 3ポチ 1こ



ながさに
ちゅうい

3

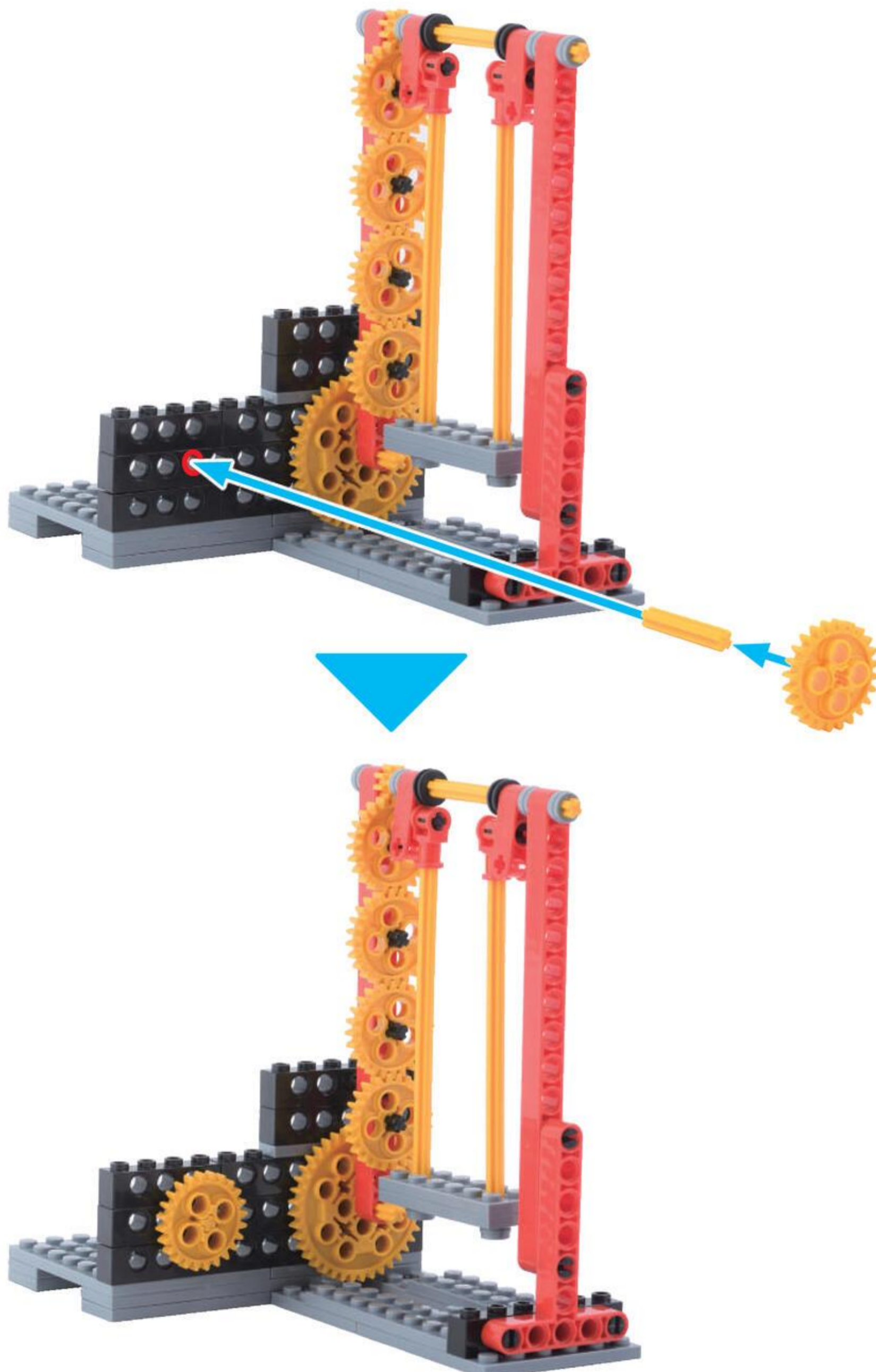

peg 2
peg S 2

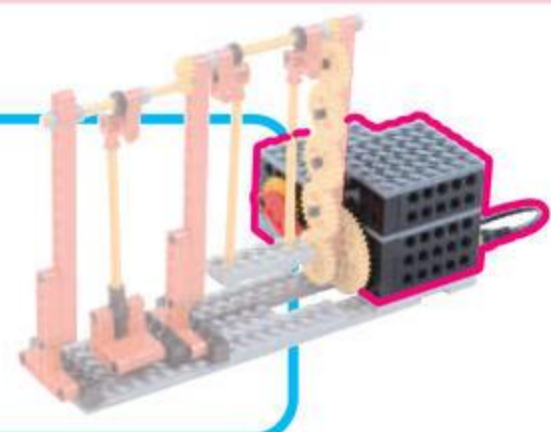

4

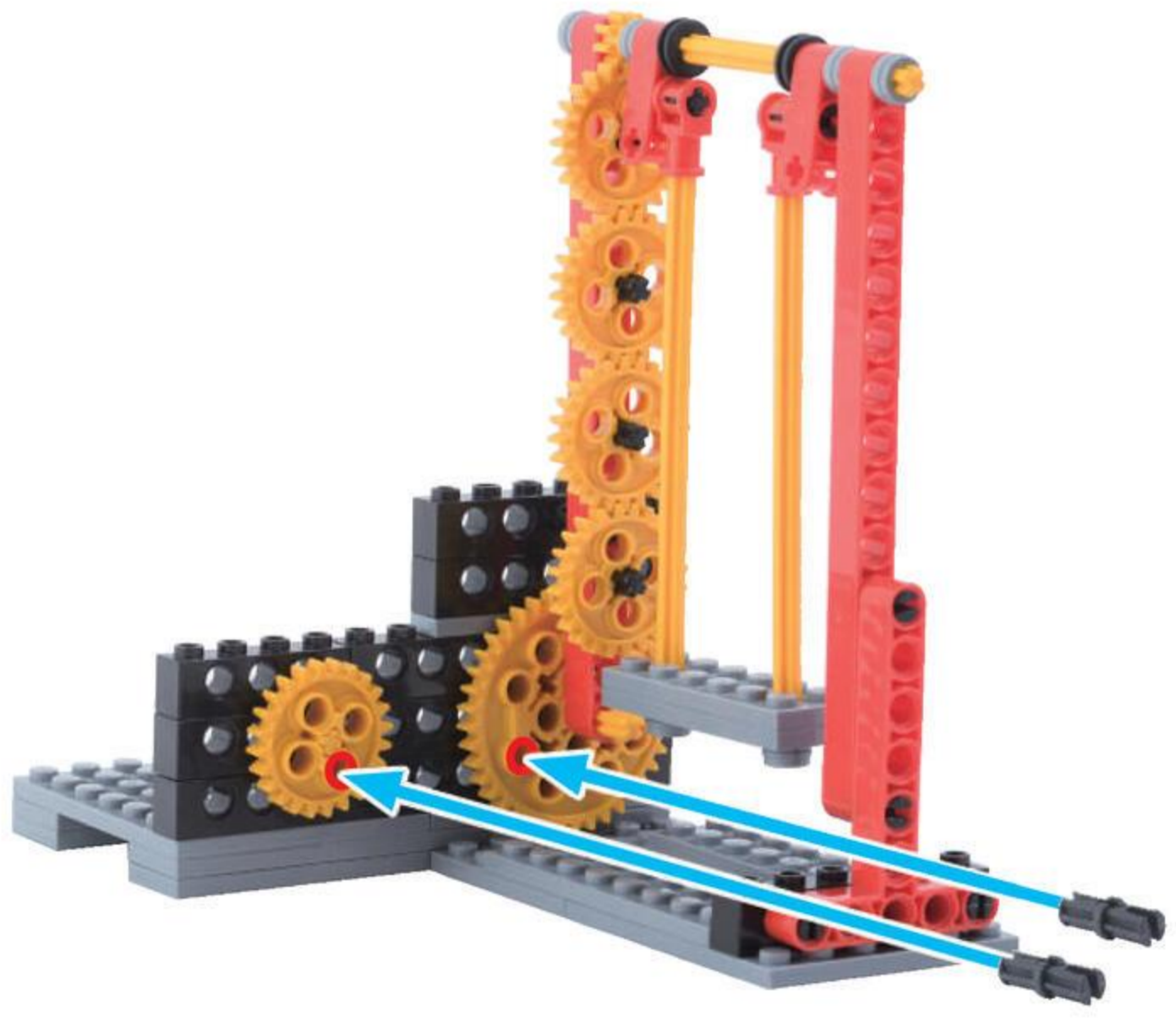

ろっどなあな 1こ
ロッド7アナ

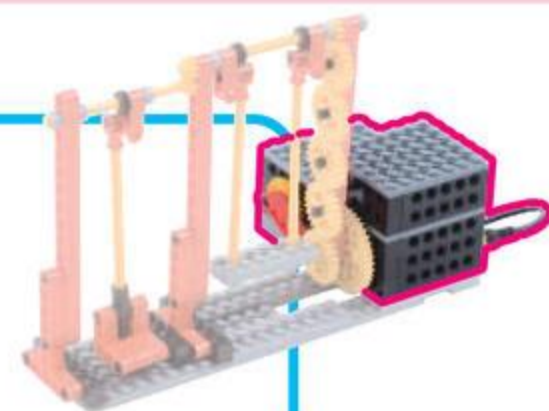

5

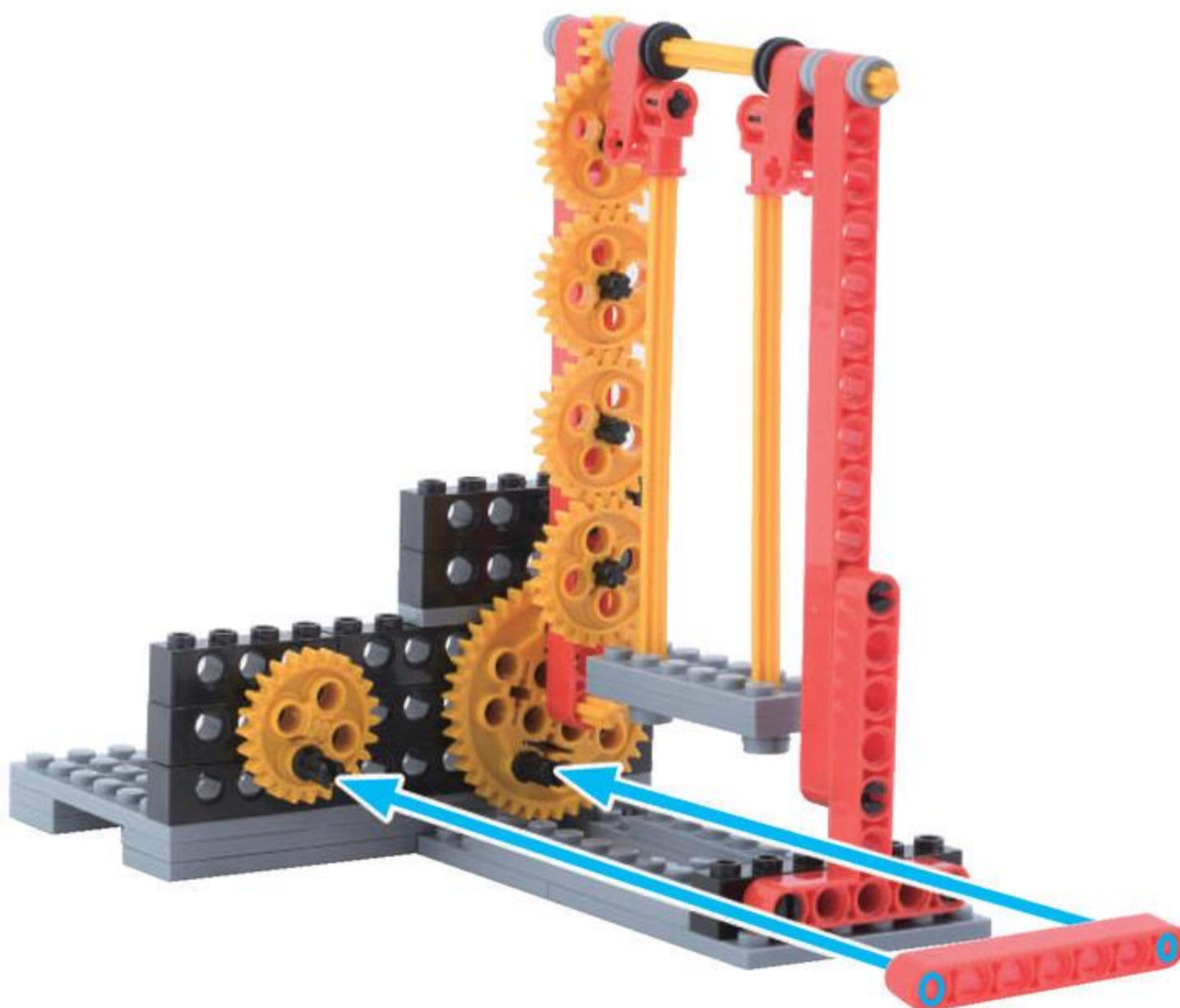

ぎあえむ
ギアMをうごかして
さしこめるいちをさがそう

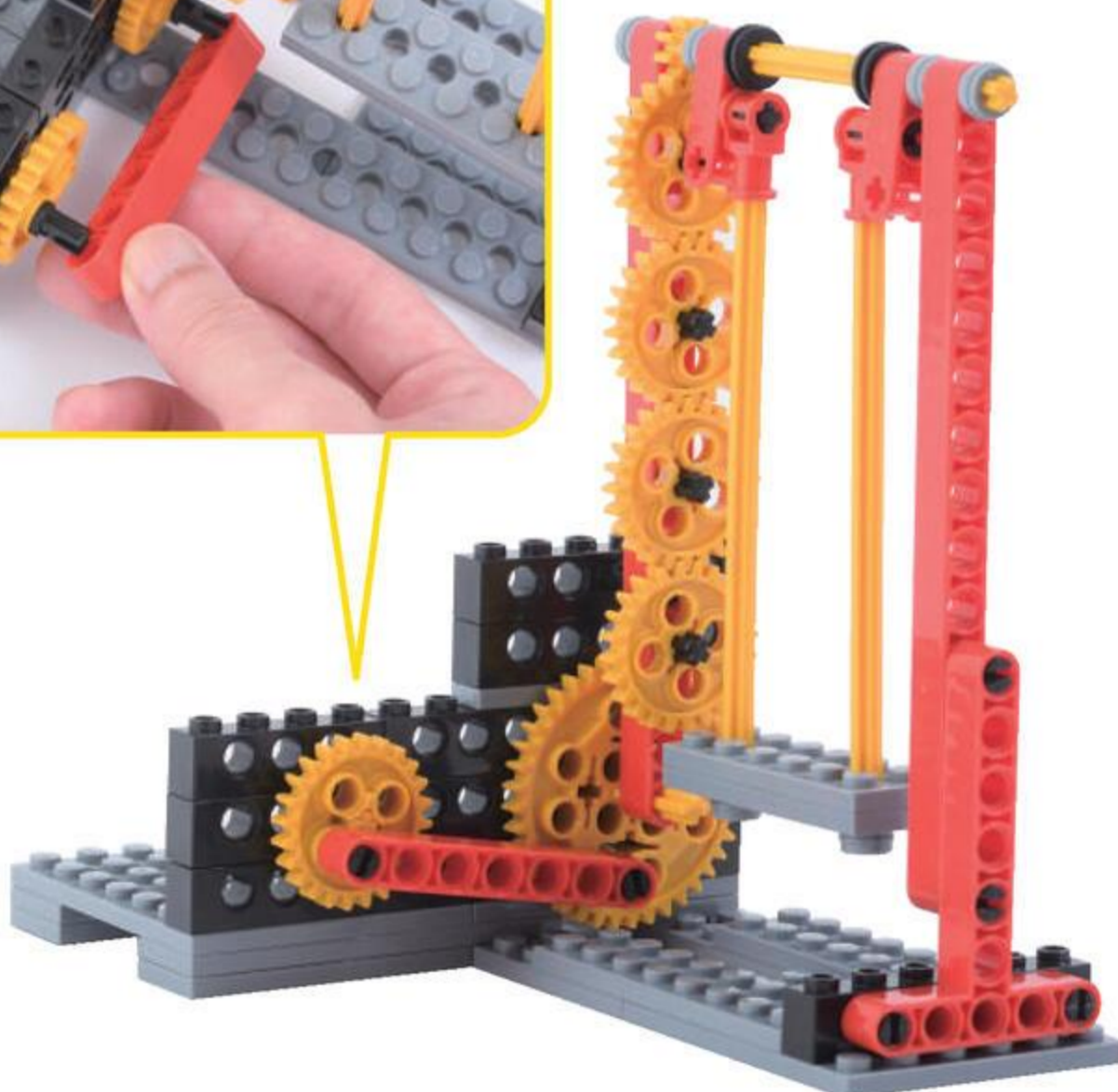
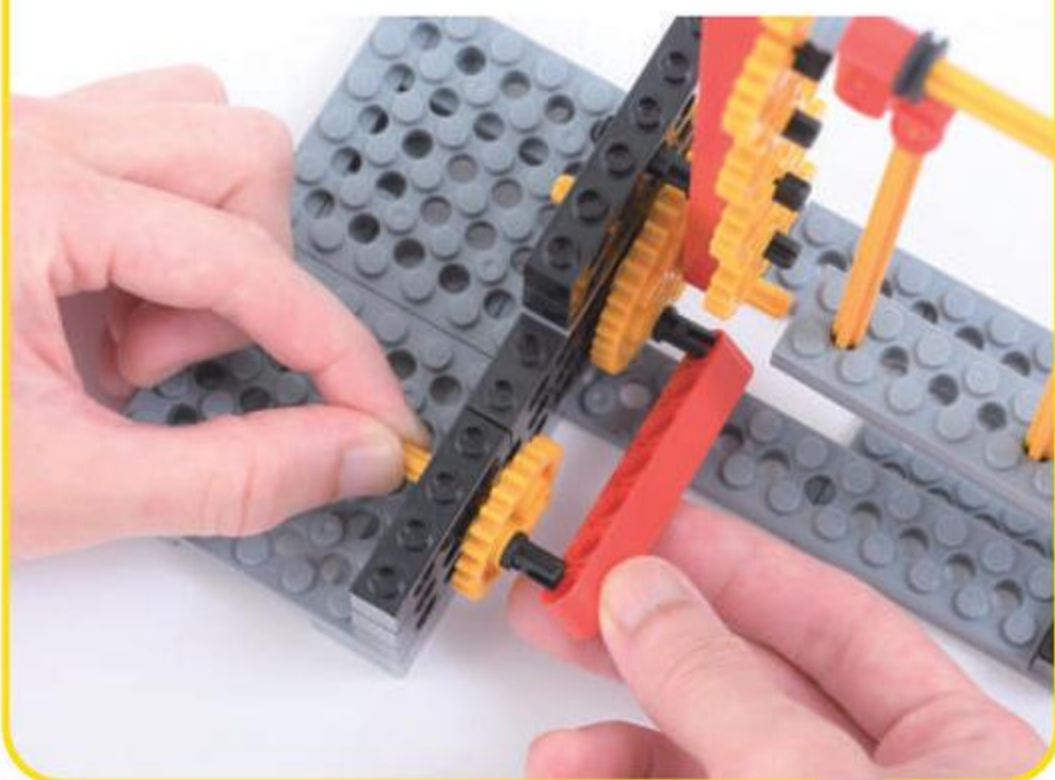

ぎあえむ
ギアMうす 1こ

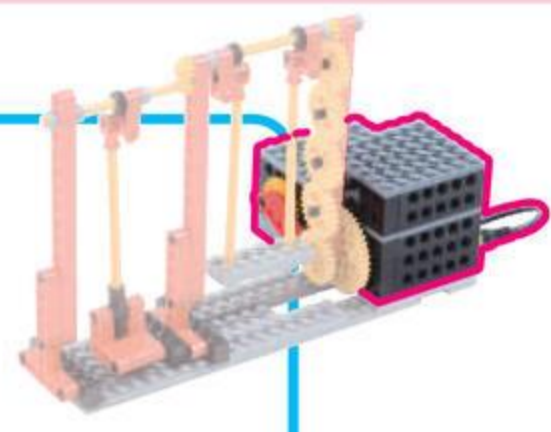
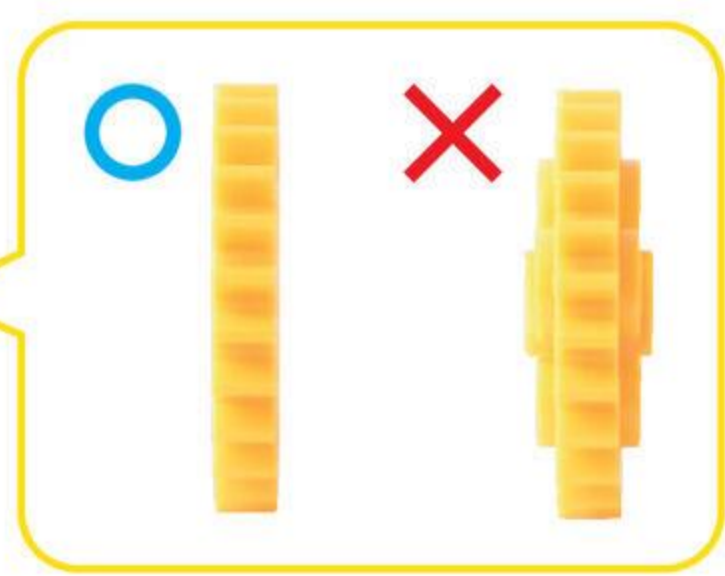
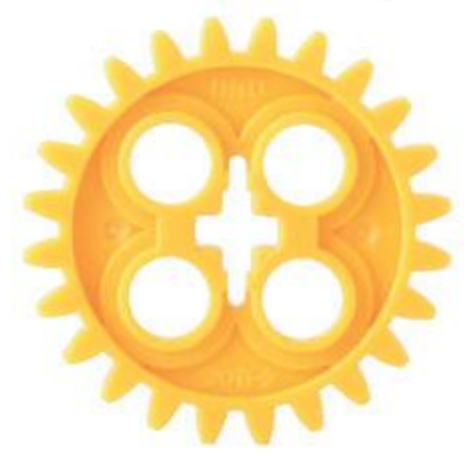

6

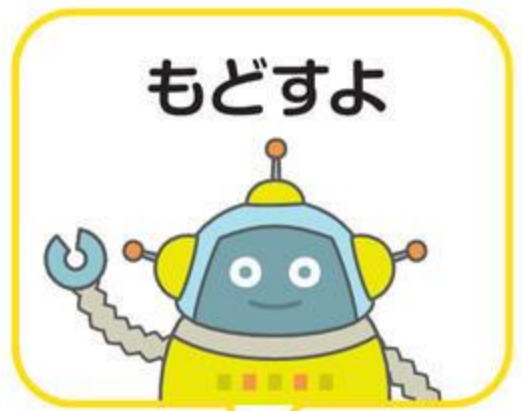
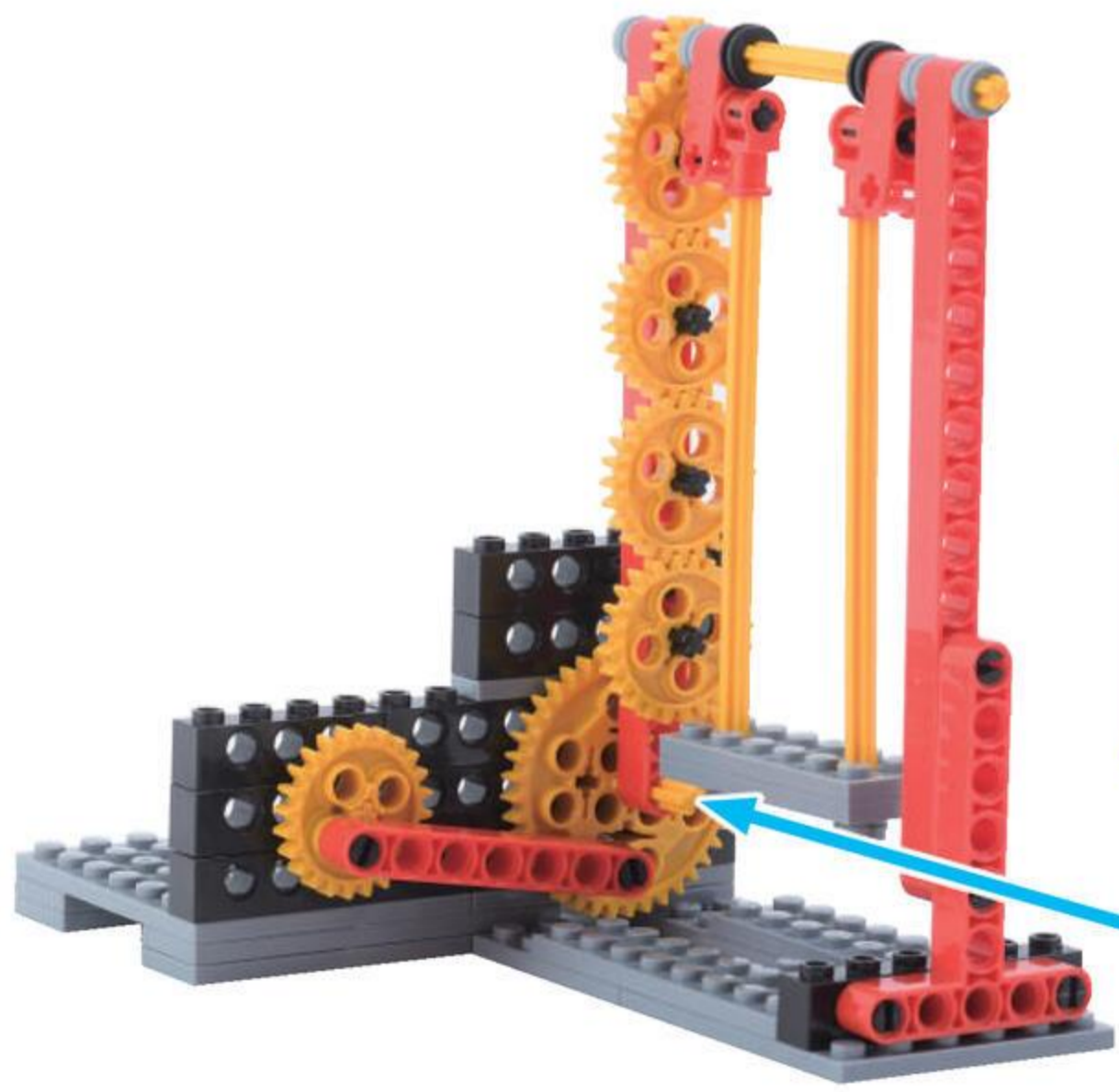

ぎあえむ
ギア M 1こ

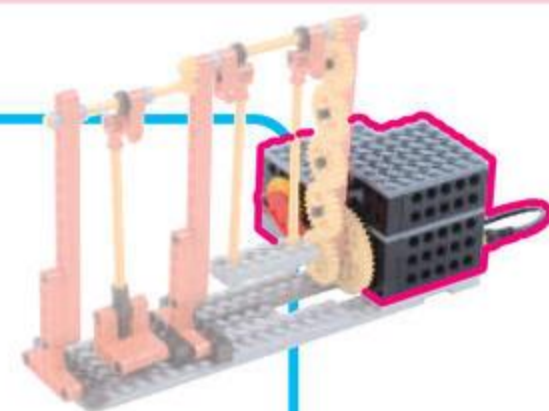

7

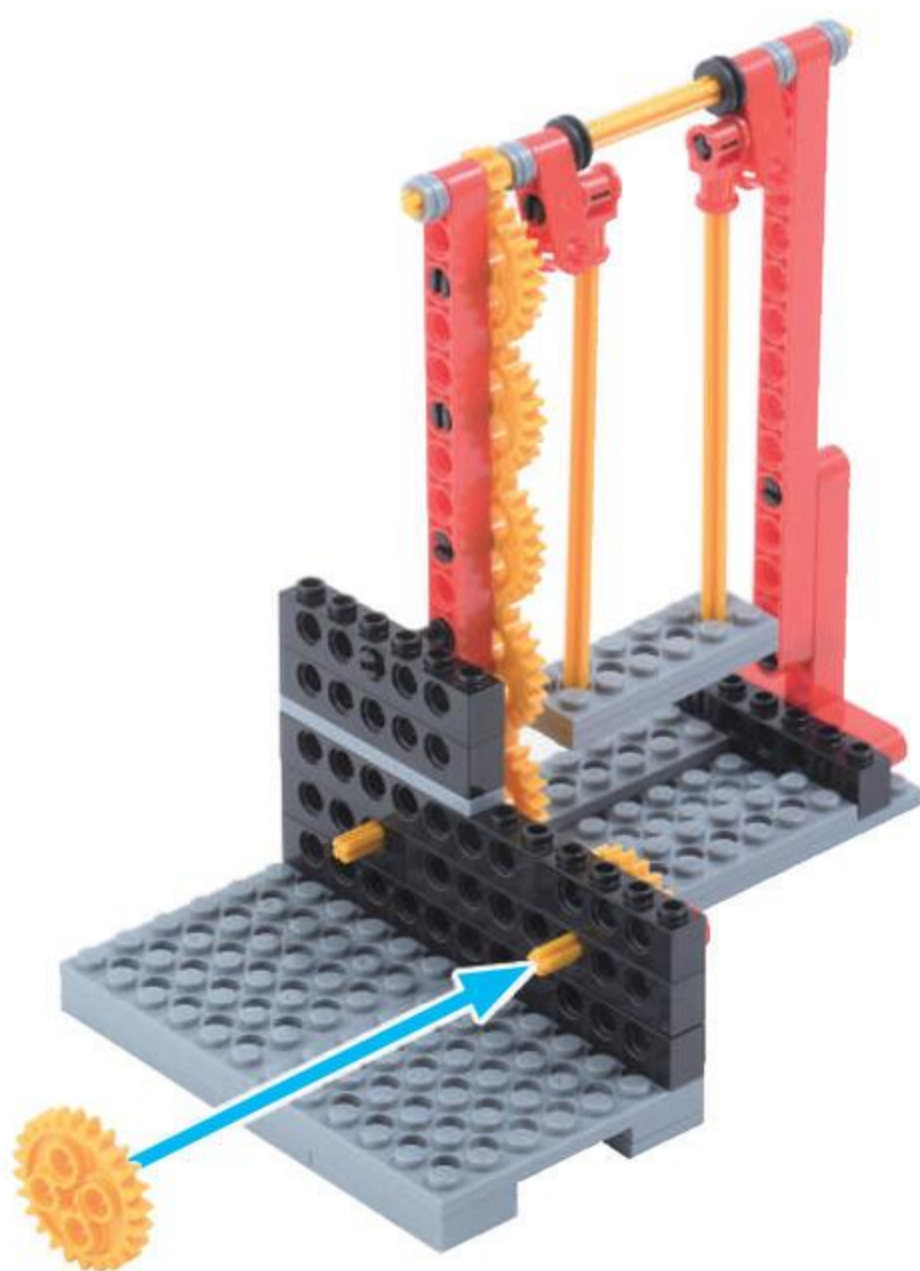

ふとぶれえとろくほち
太プレート6ポチ 1こ

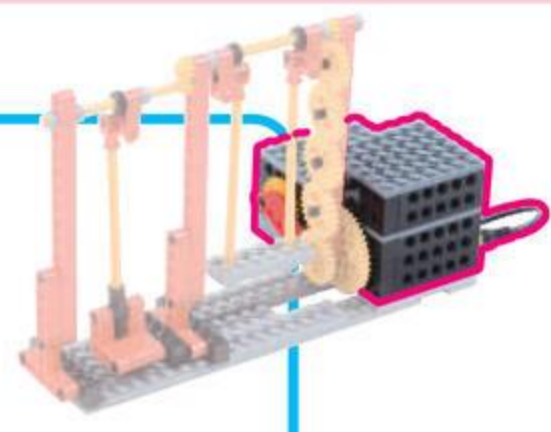

8

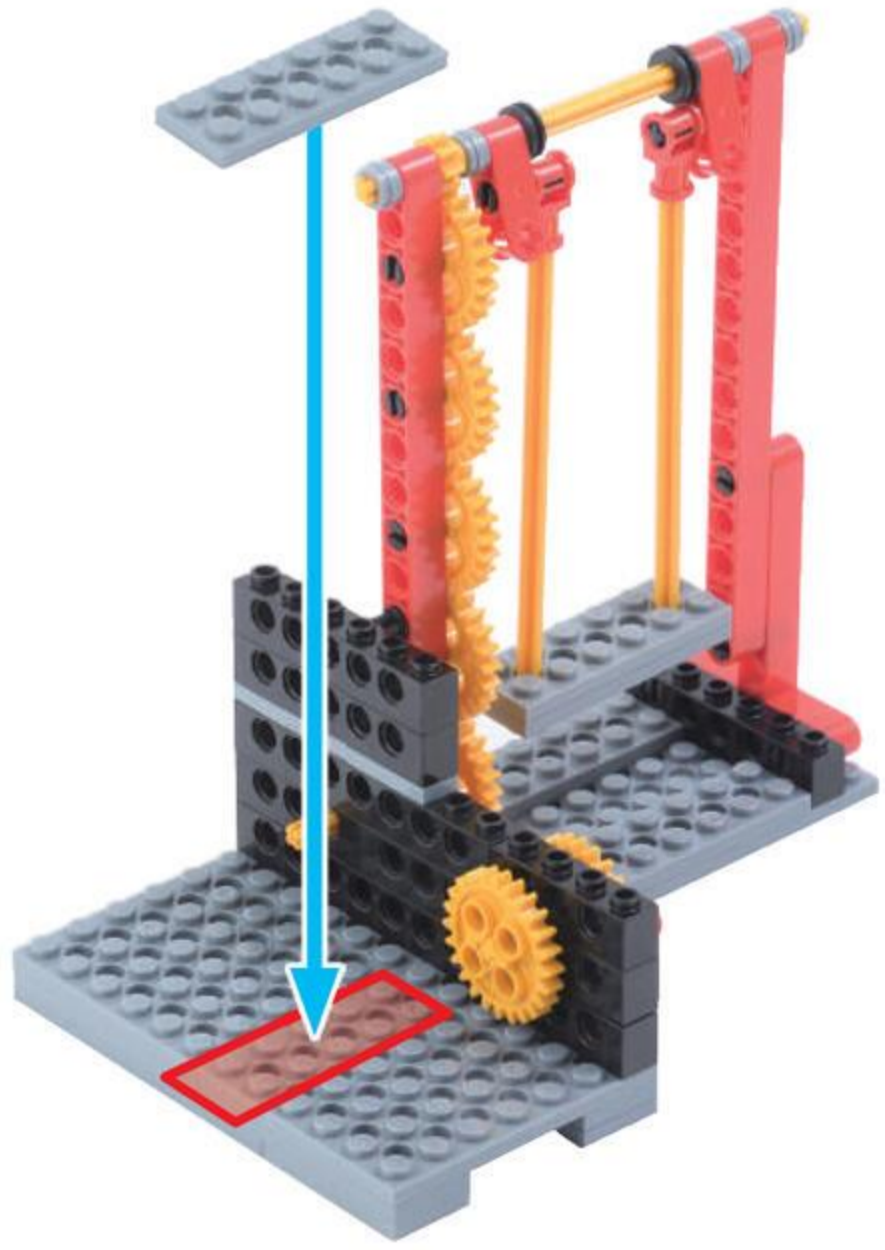

ほち
1ポチ であるよ

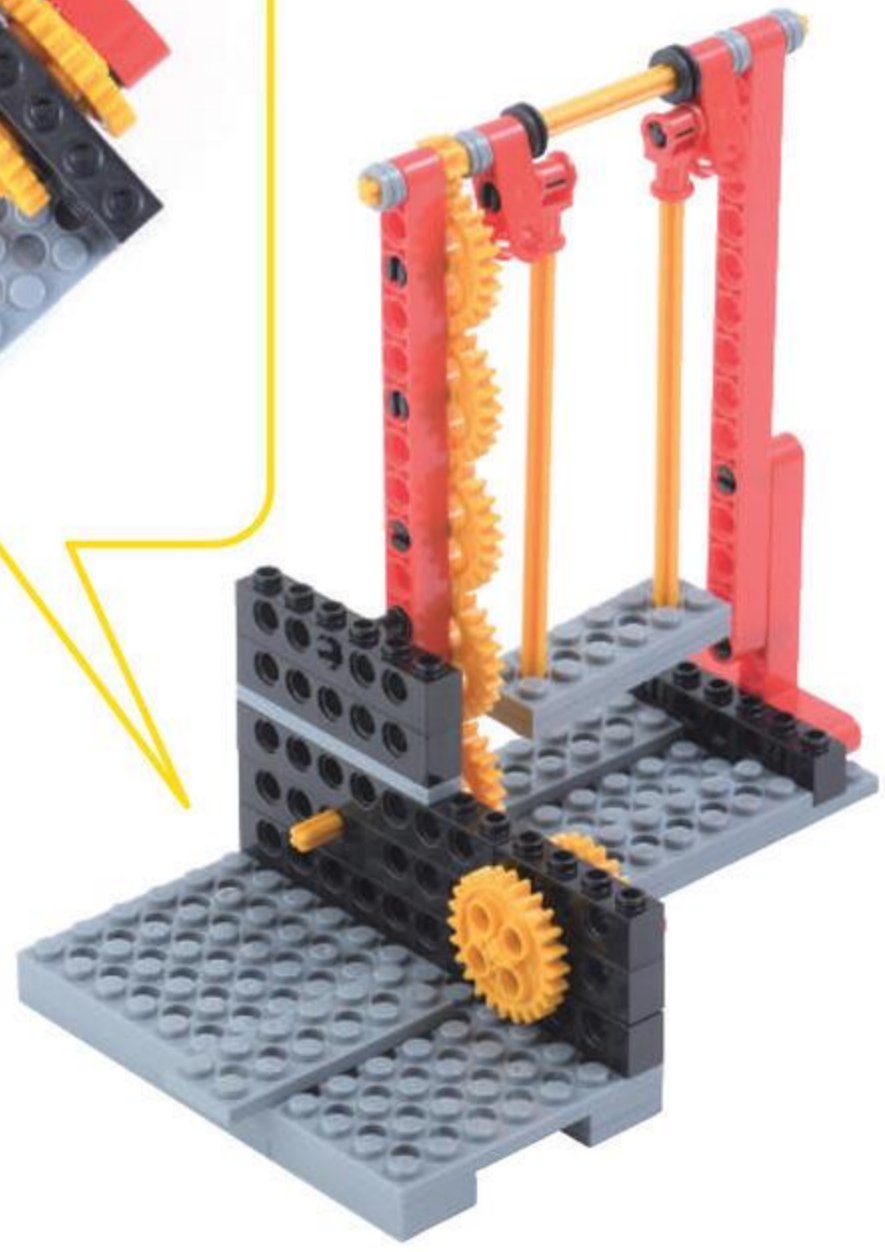

もおたあせつと
モーターセット 1こ

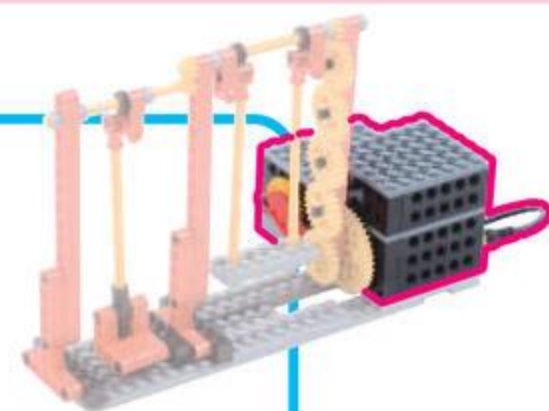
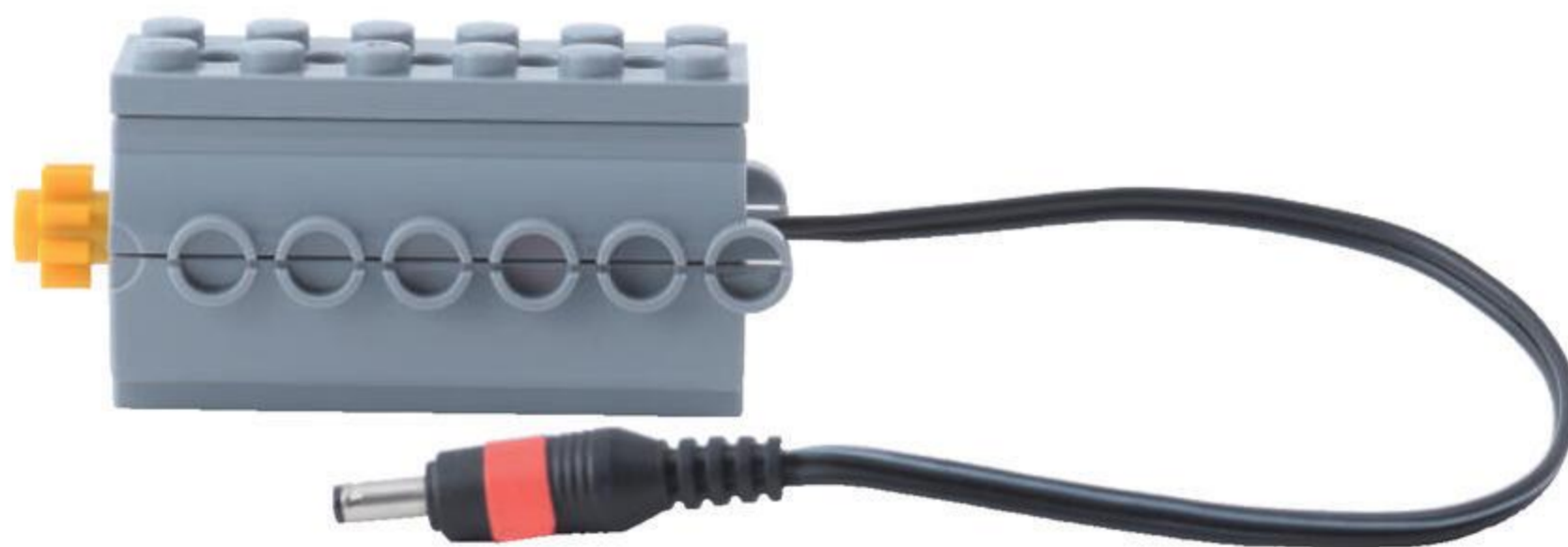

9

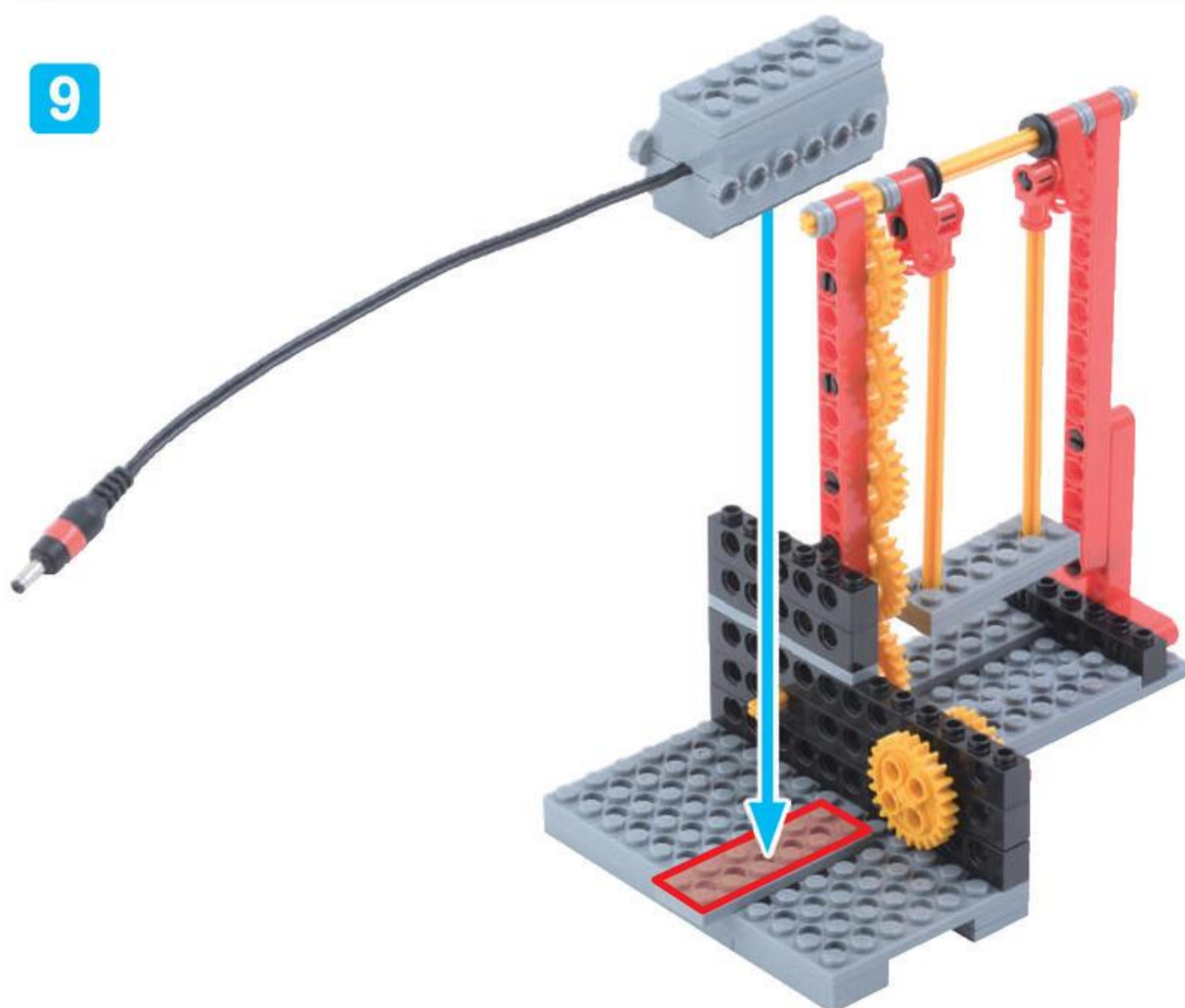

ぎあ
ギアを
かみあわせよう



びいむろくぼち
ビーム 6 ポチ **8** こ



ほそぶれえとろくぼち
細プレート 6 ポチ **1** こ

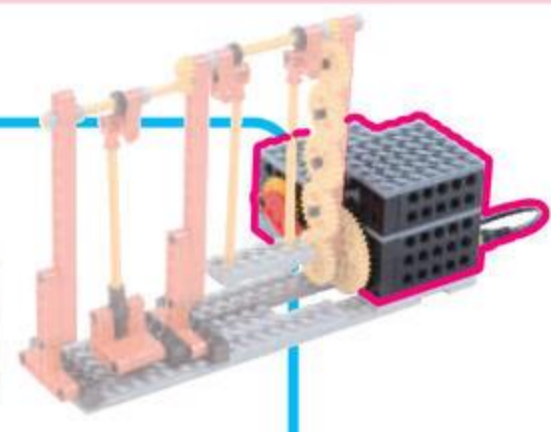

10

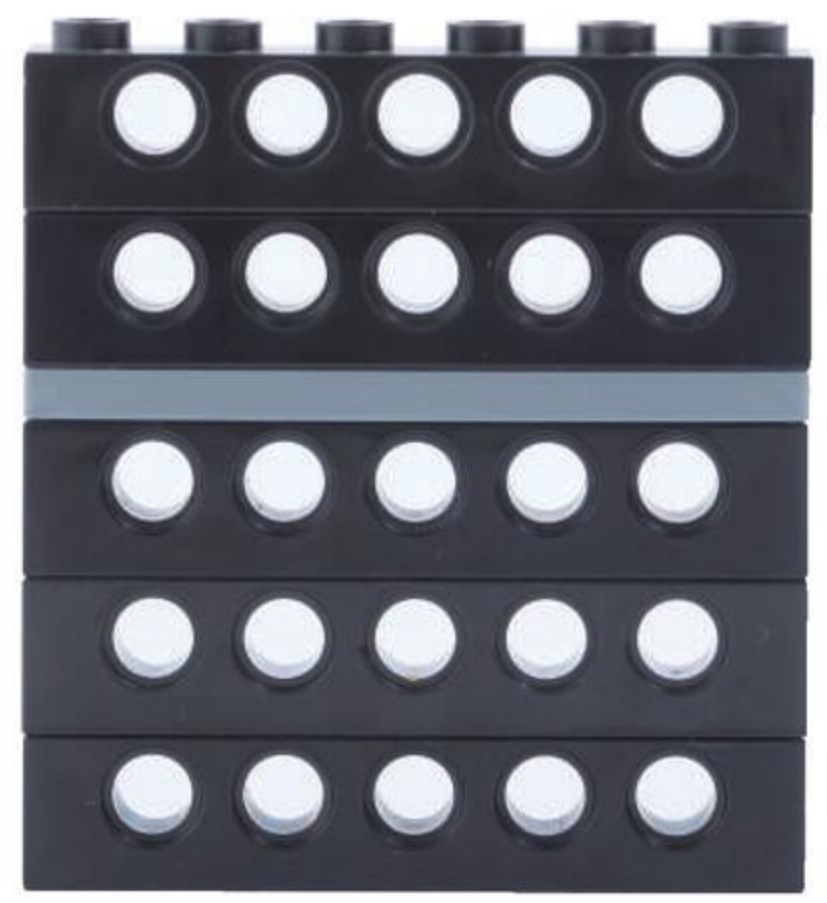
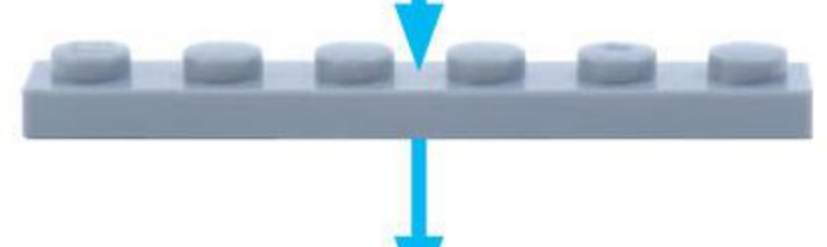

11

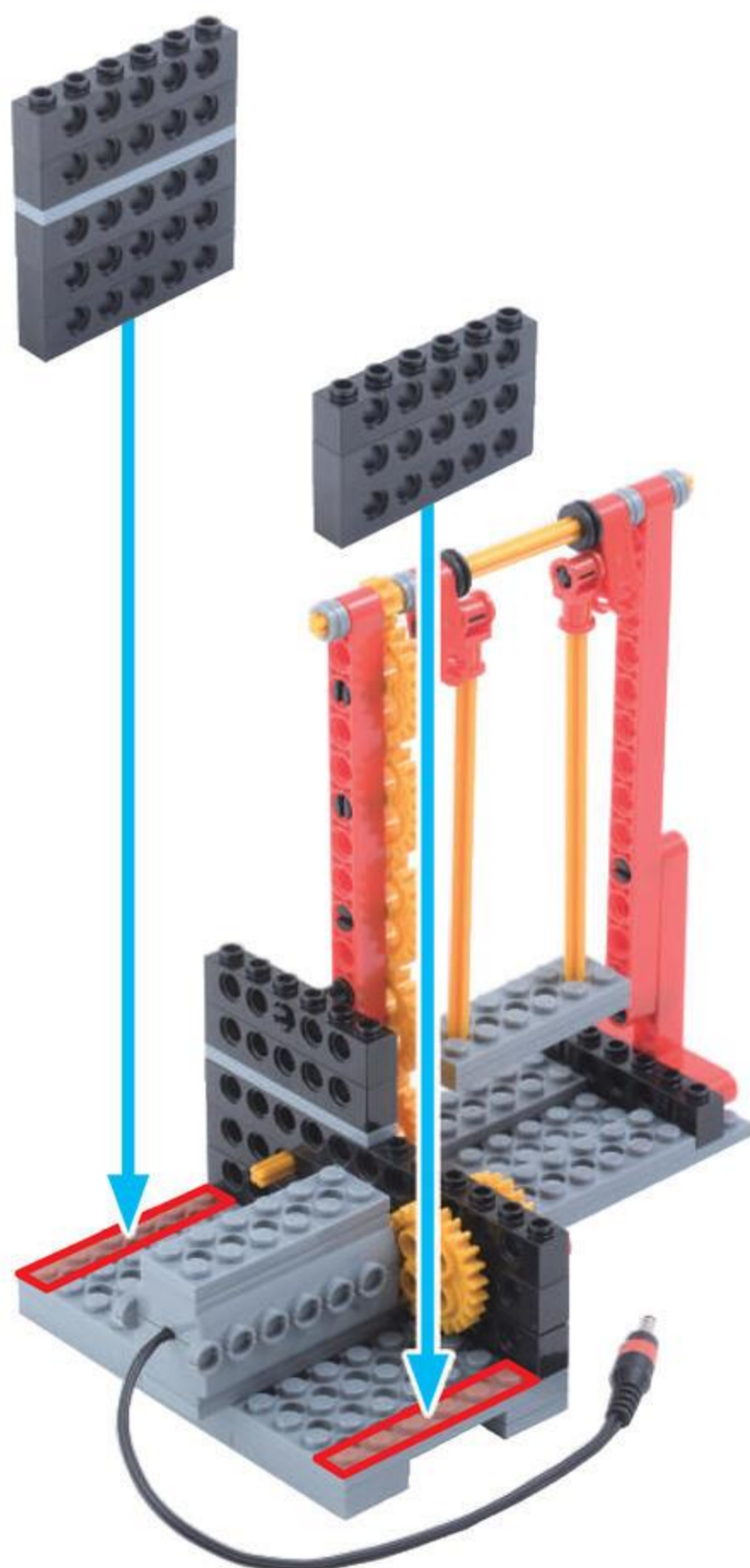
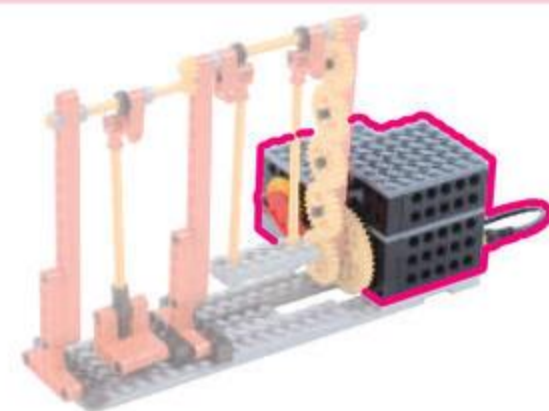

ばってりいぼっくす すらいどすいっち 1こ
バッテリーボックス / スライドスイッチ 1こ

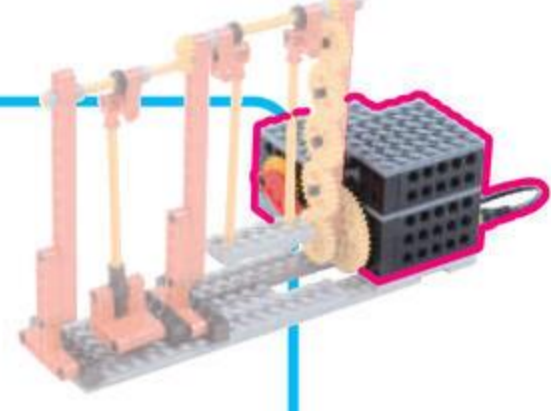

たっちせんさあくろ
タッチセンサー黒 1こ



12

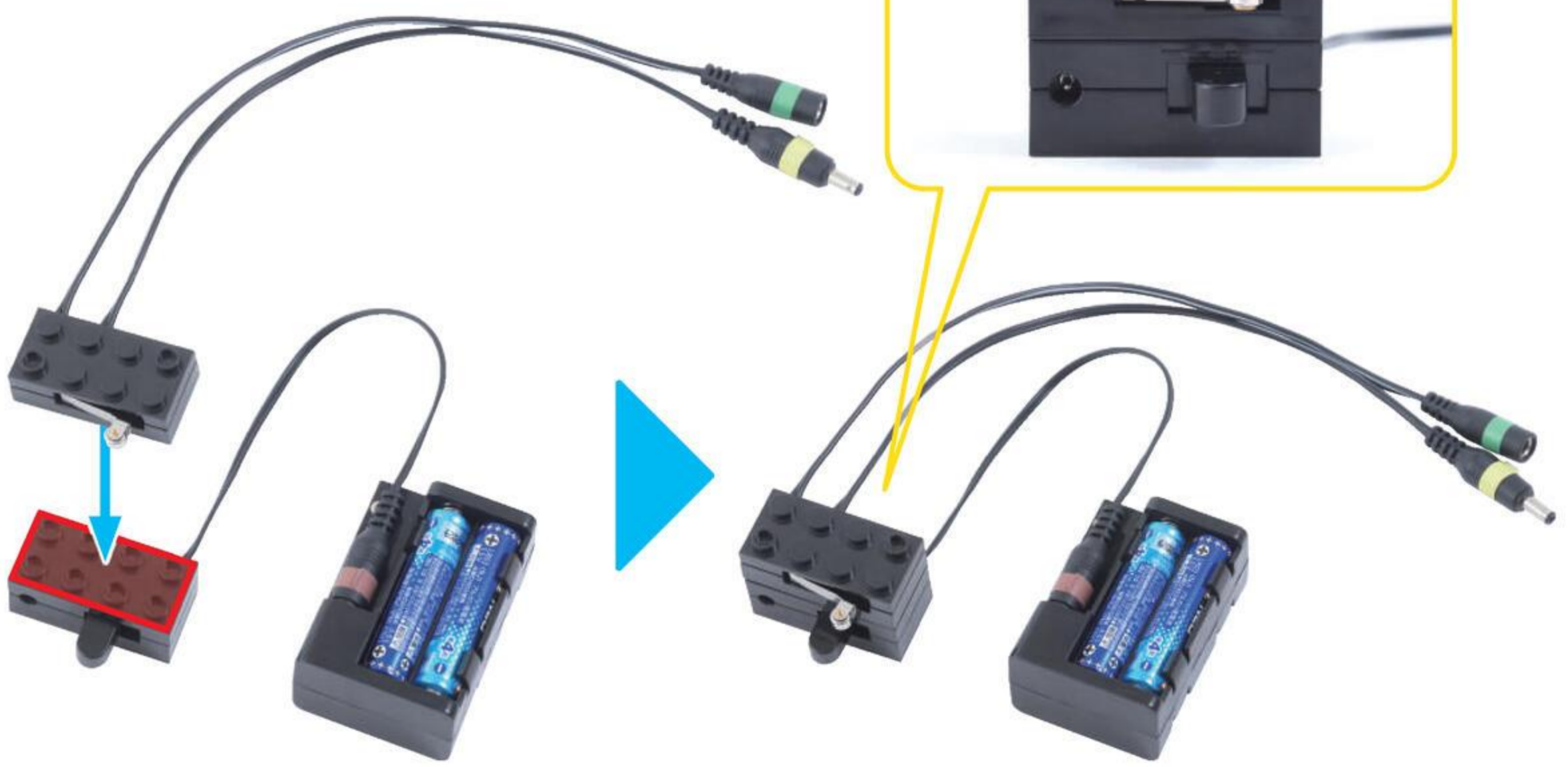

13

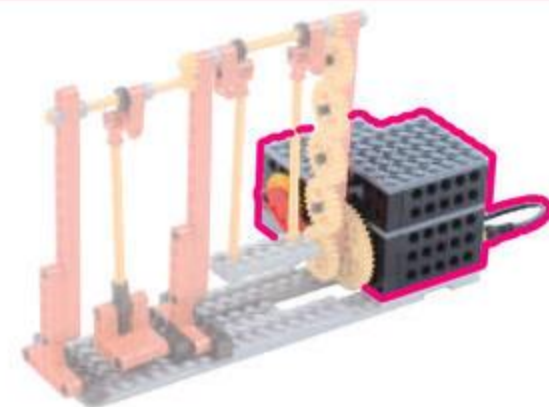

ばってりいほっくす
バッテリーボックスは
おくだけだよ

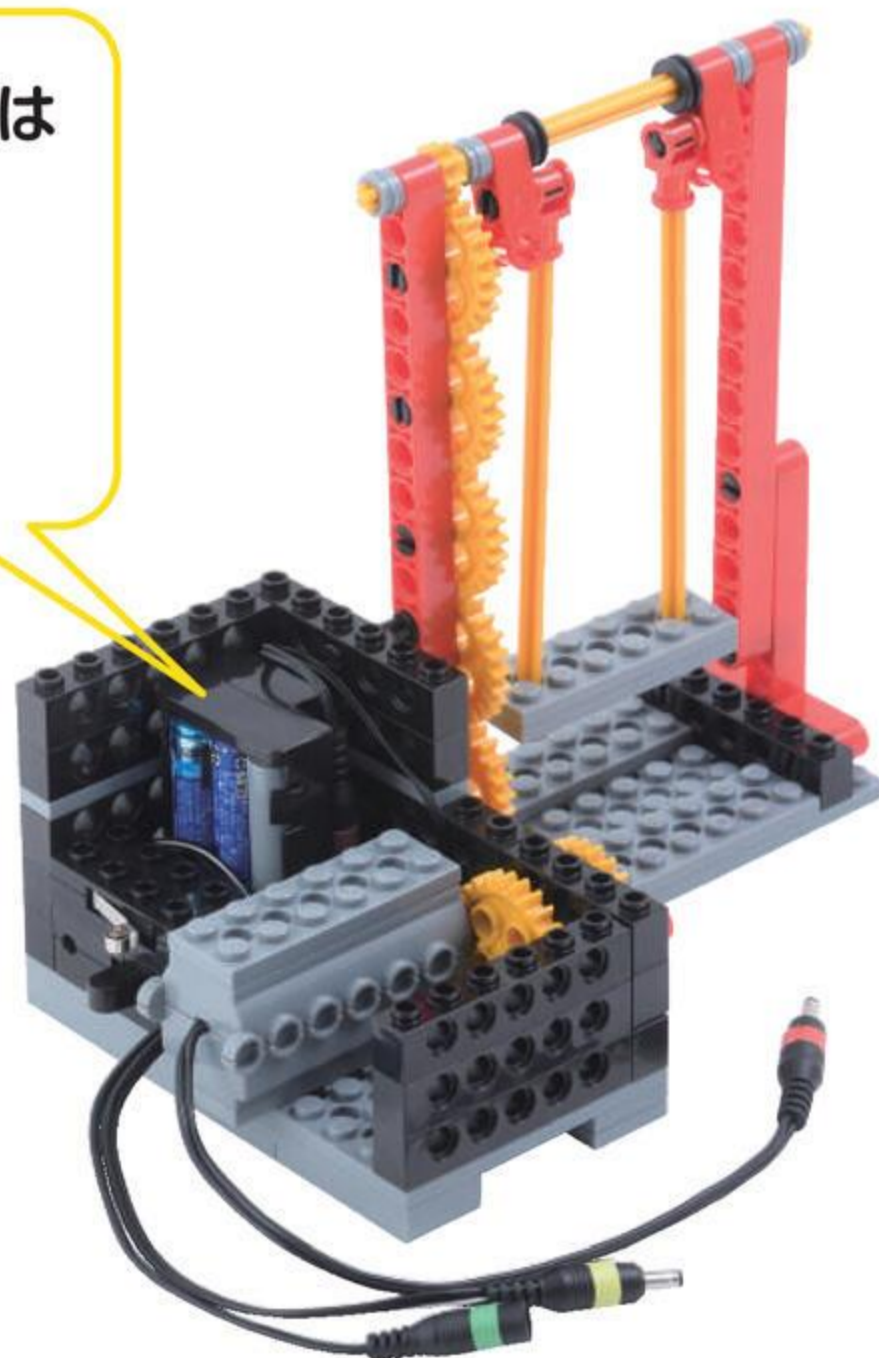
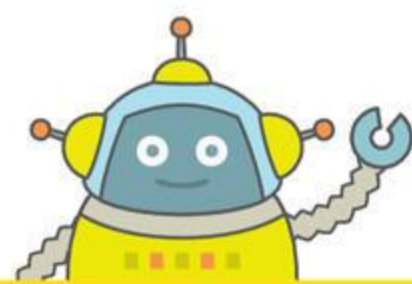

びいむよんほち
ビーム 4 ポチ **3** こ

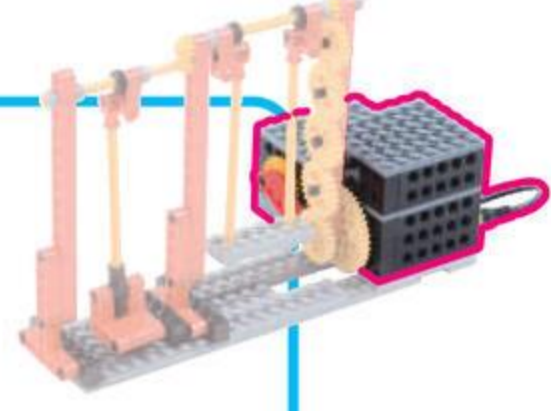

14



15

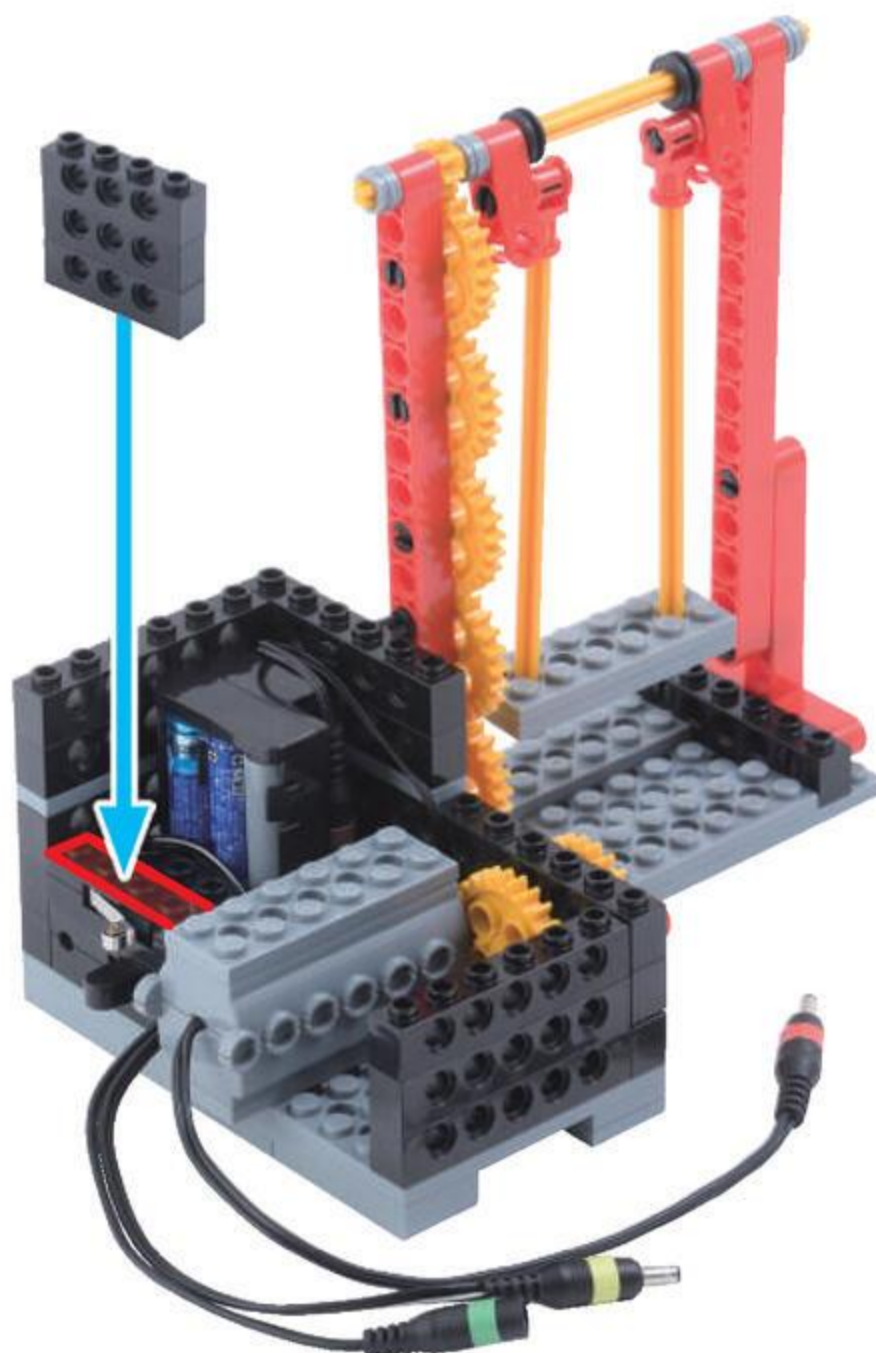
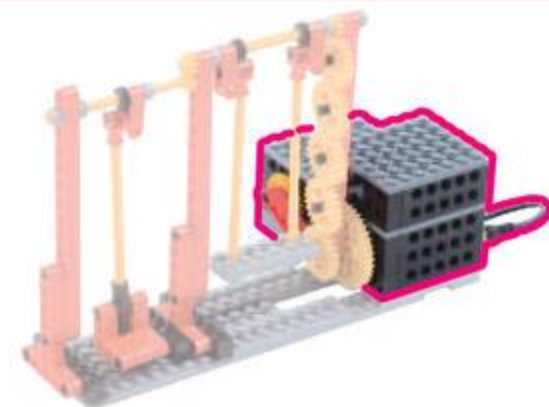

16

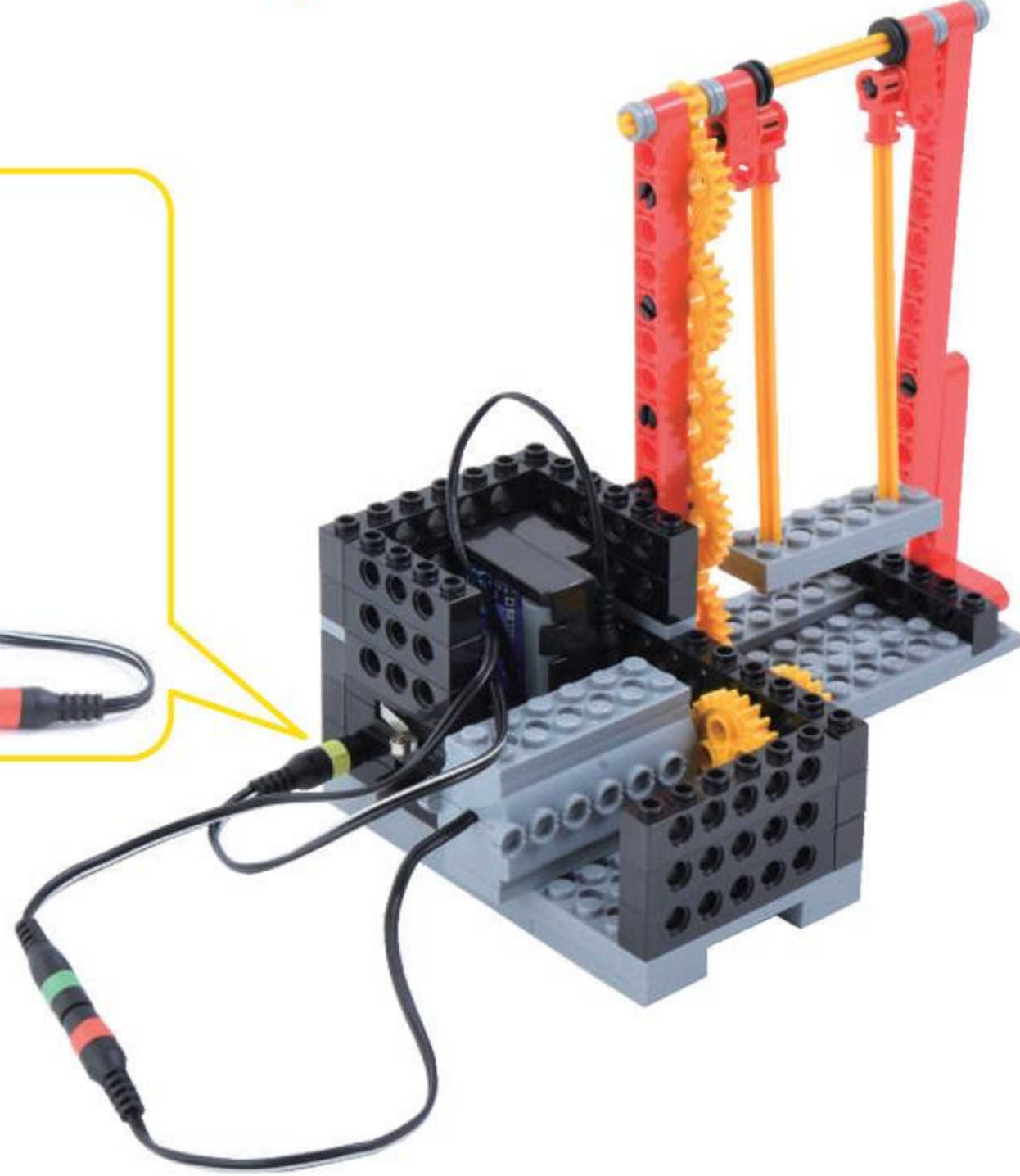
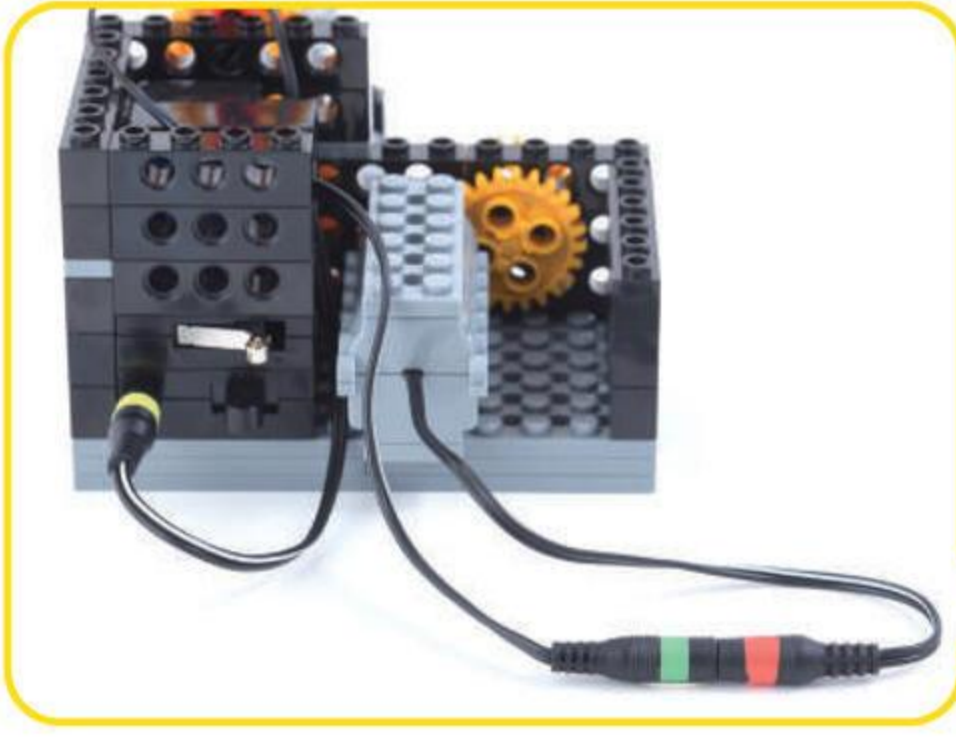
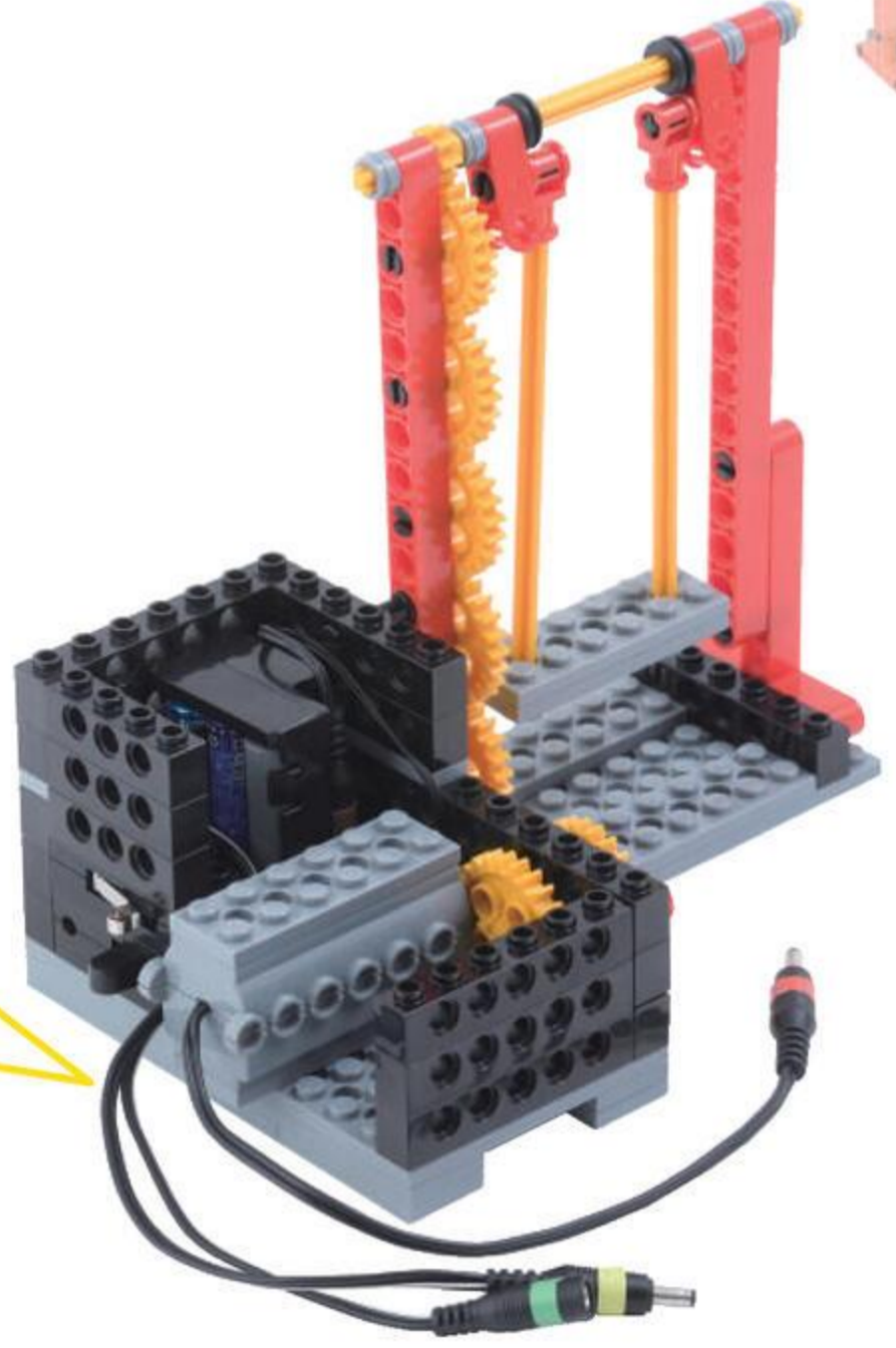
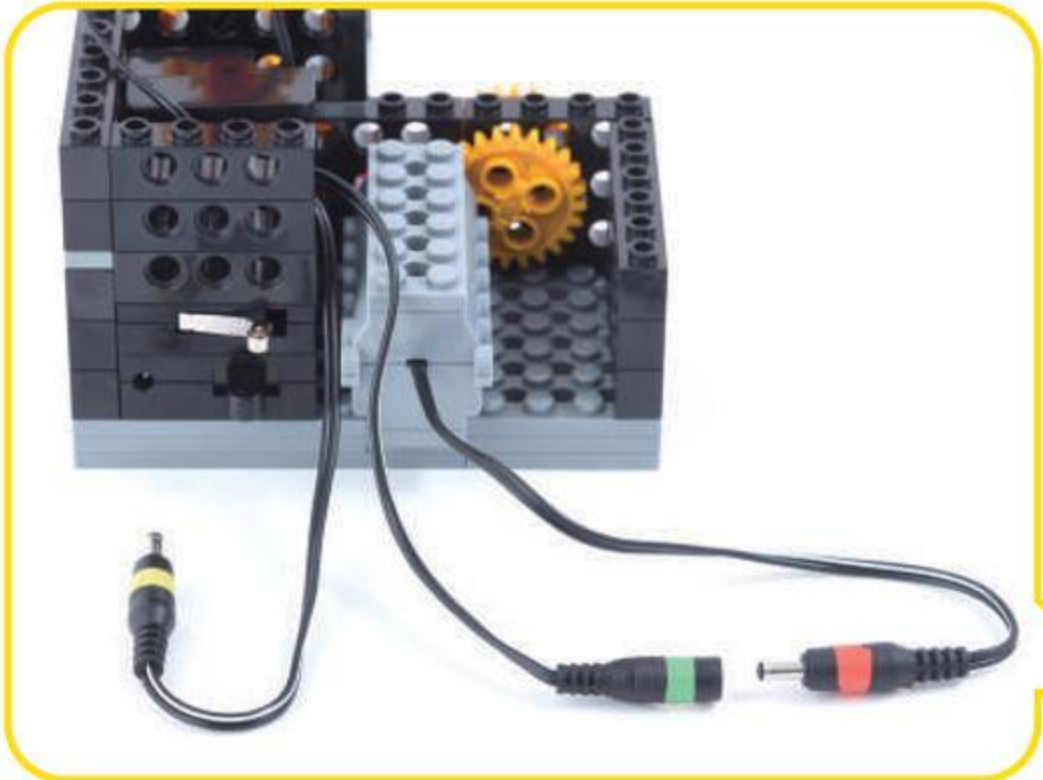
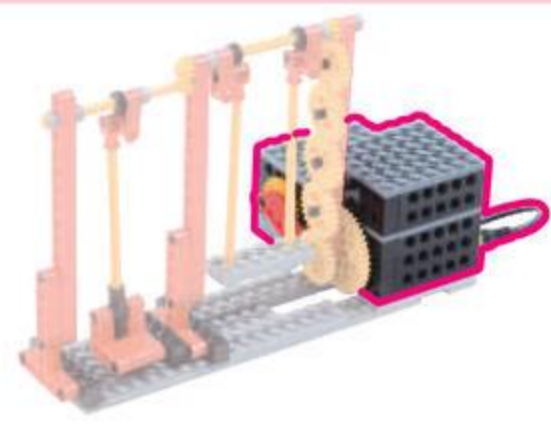

コードを
ただしく
つなごう

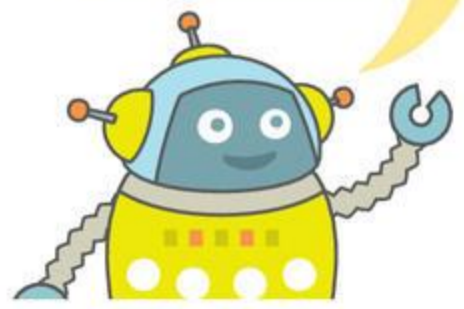

17

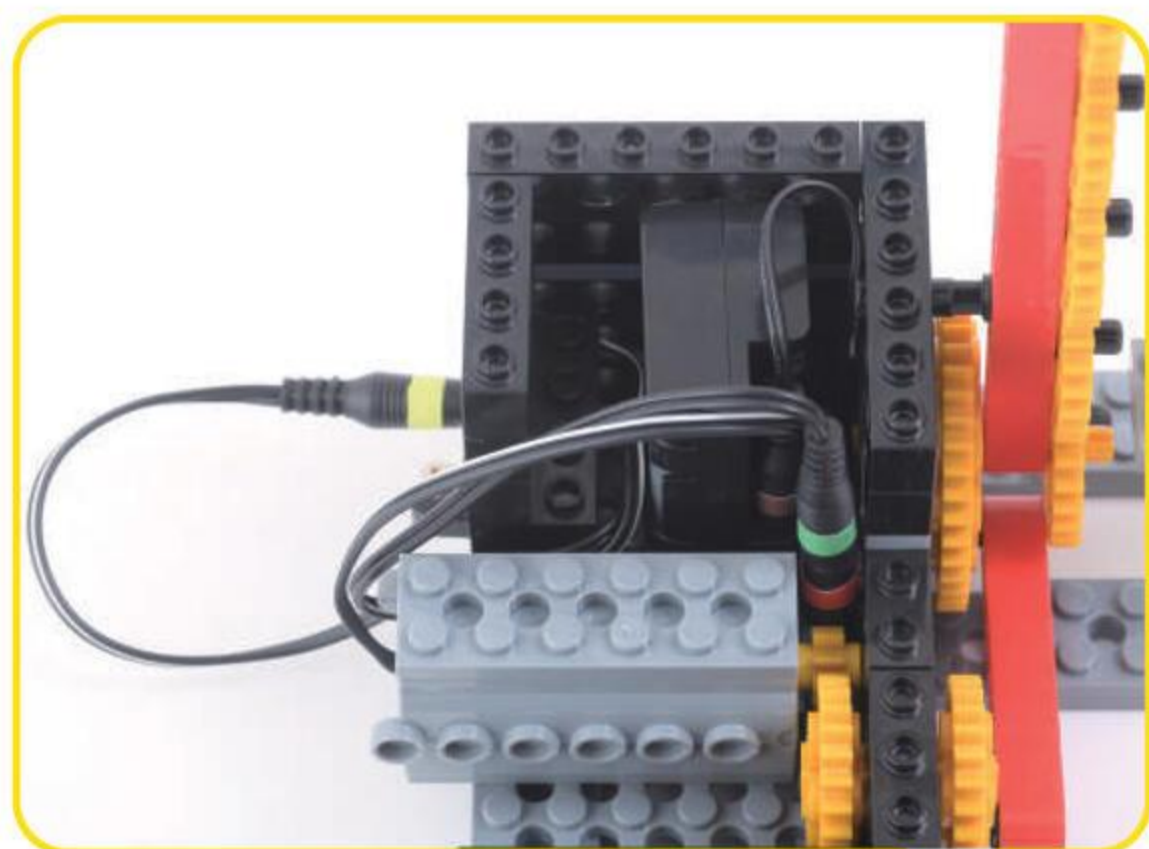
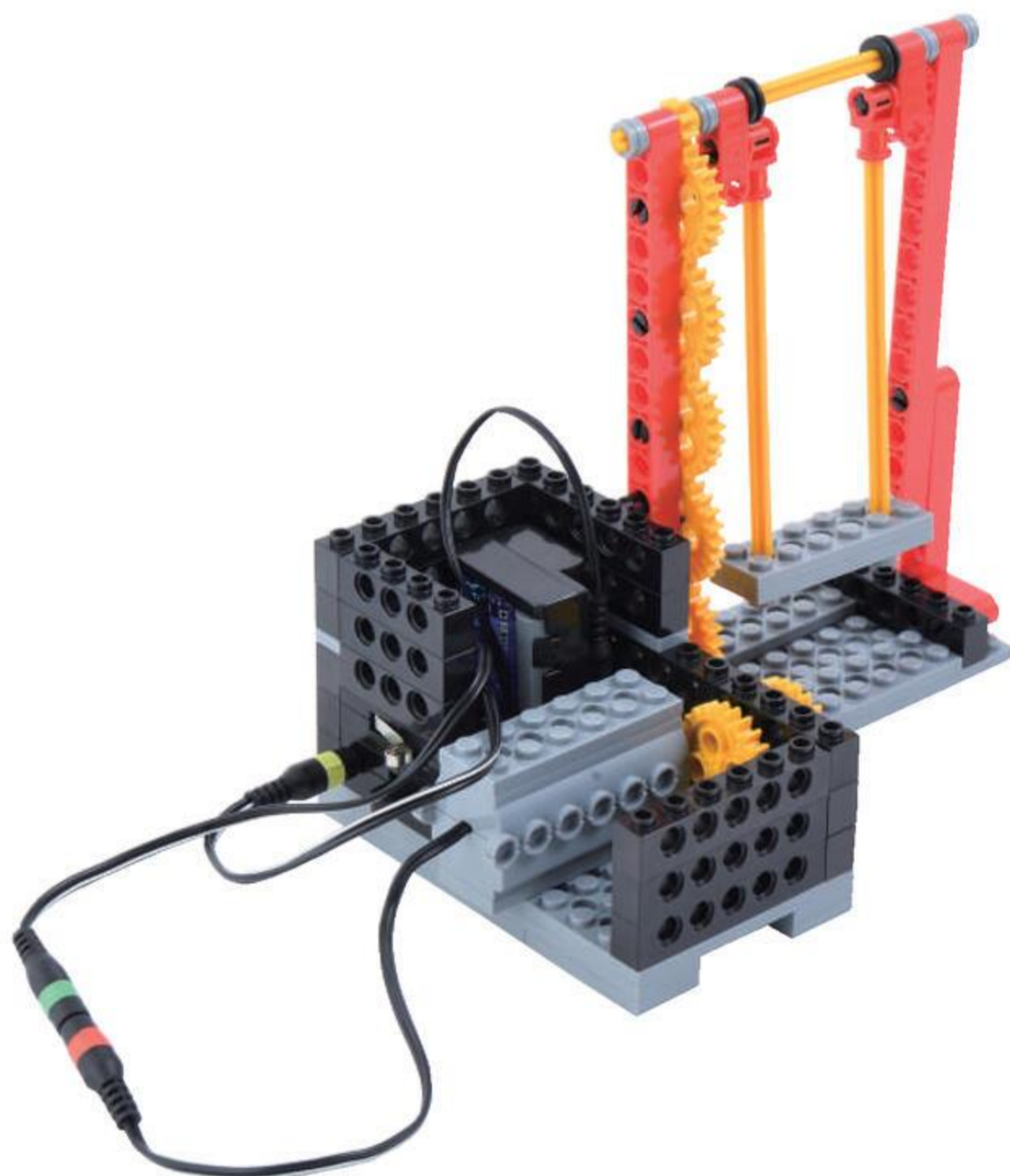
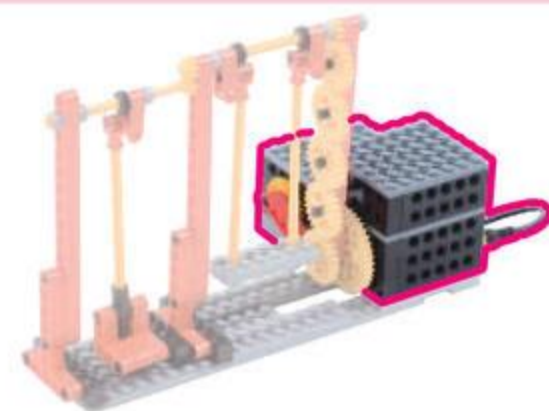

こおど
コードを たたんで
いれよう

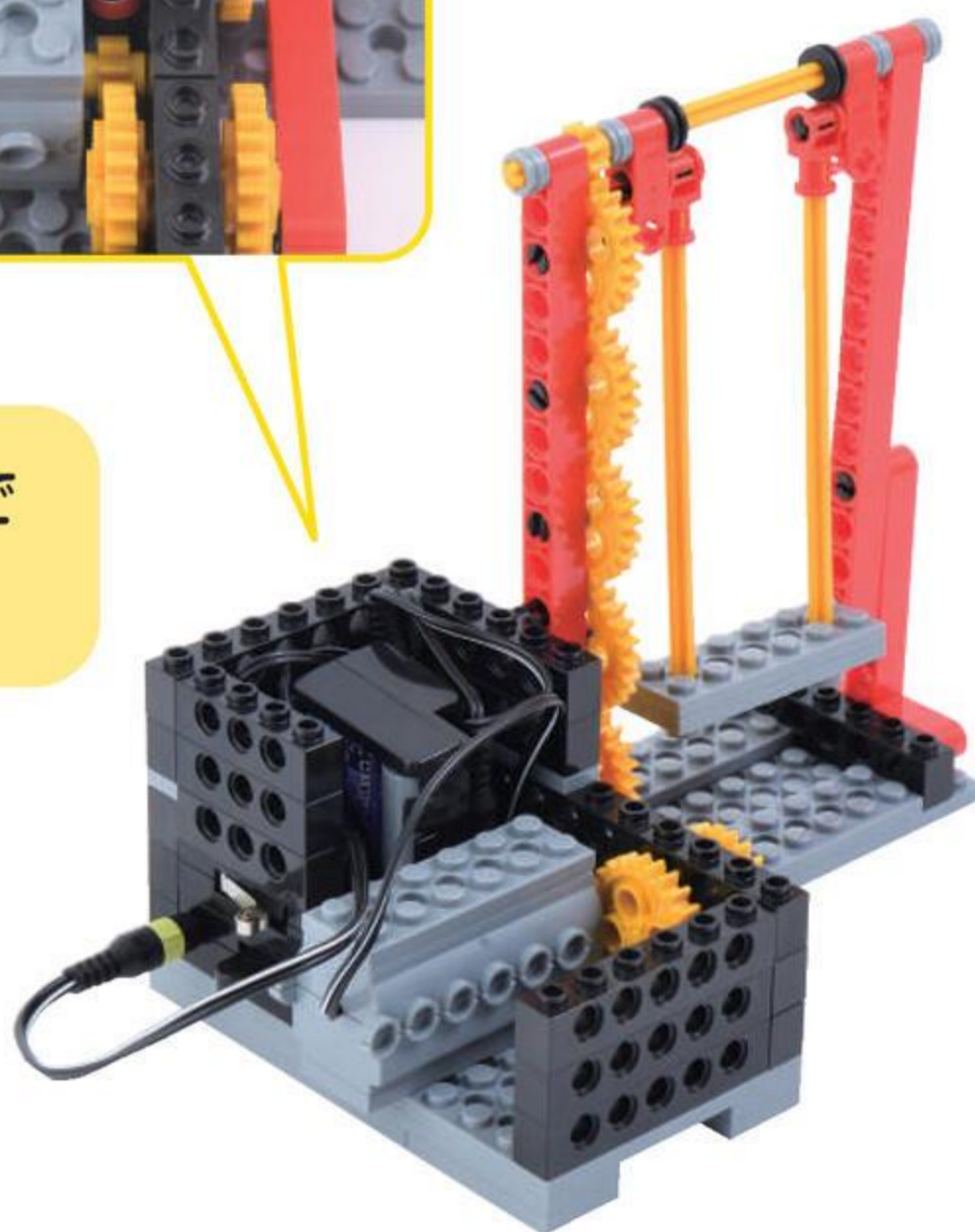
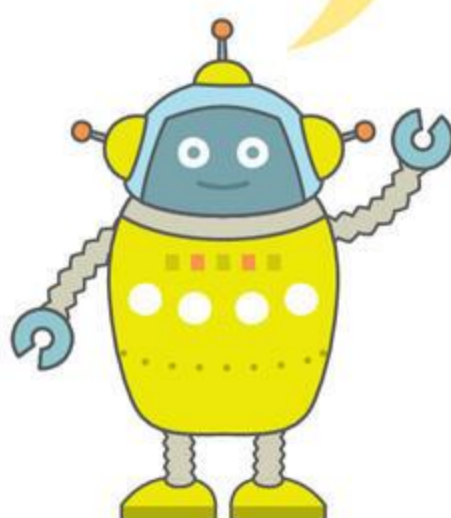

ぶれえとえろ
プレート **2**こ

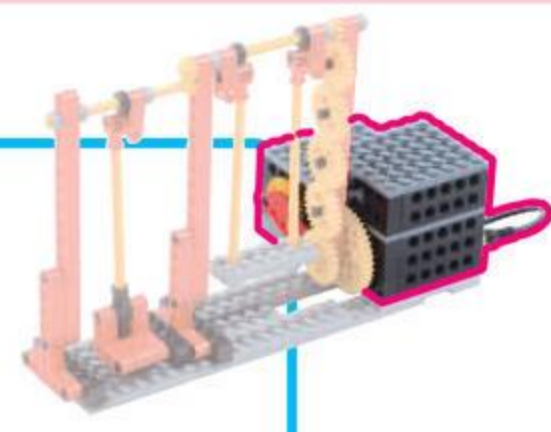
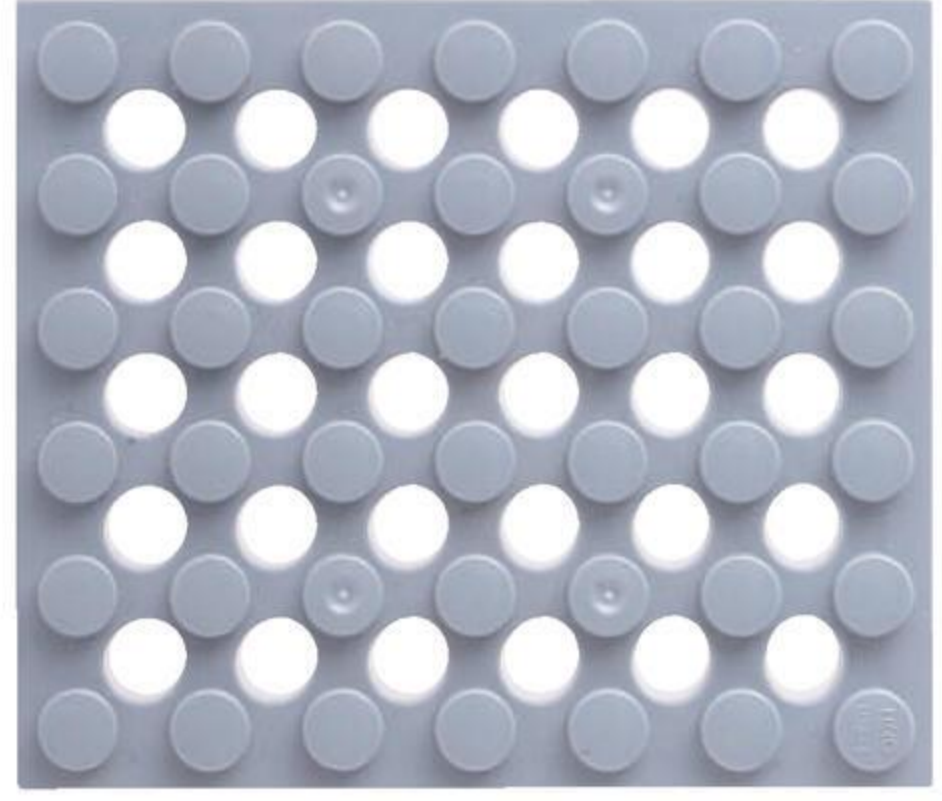

18

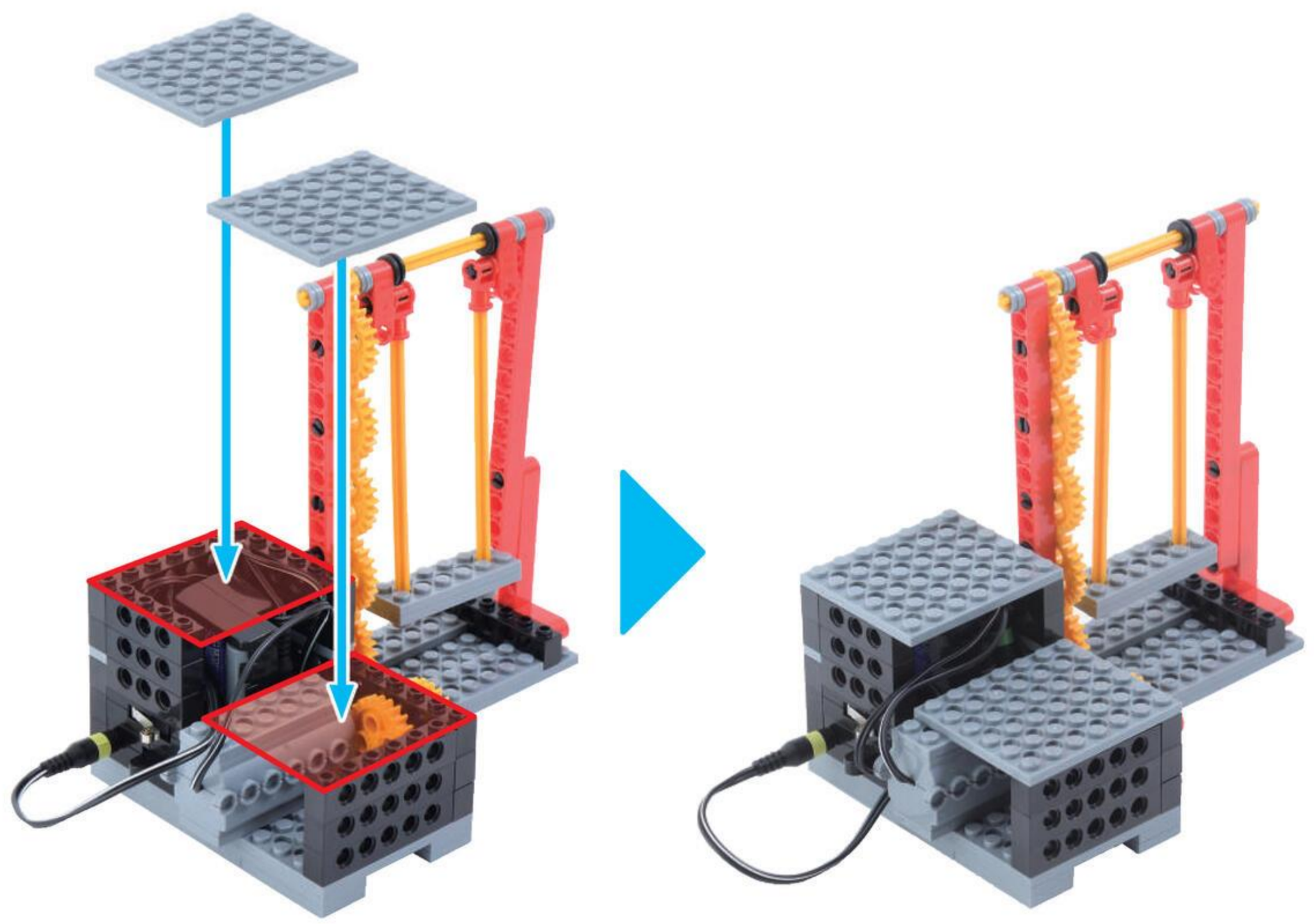

ぎあほくす
ギアボックスが
かんせい!

やったね!

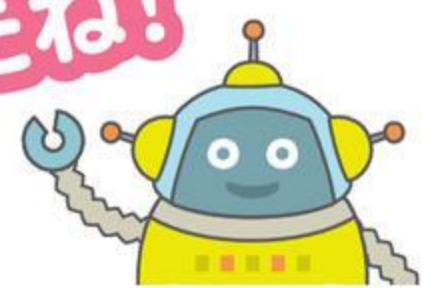

ロボットをうごかそう

めやす 5 ぶん

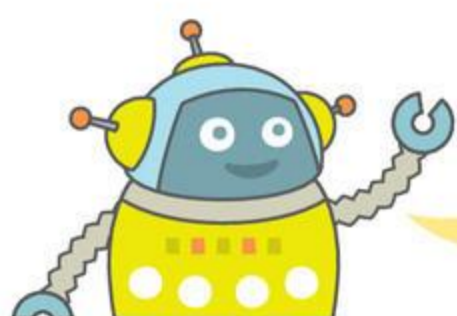
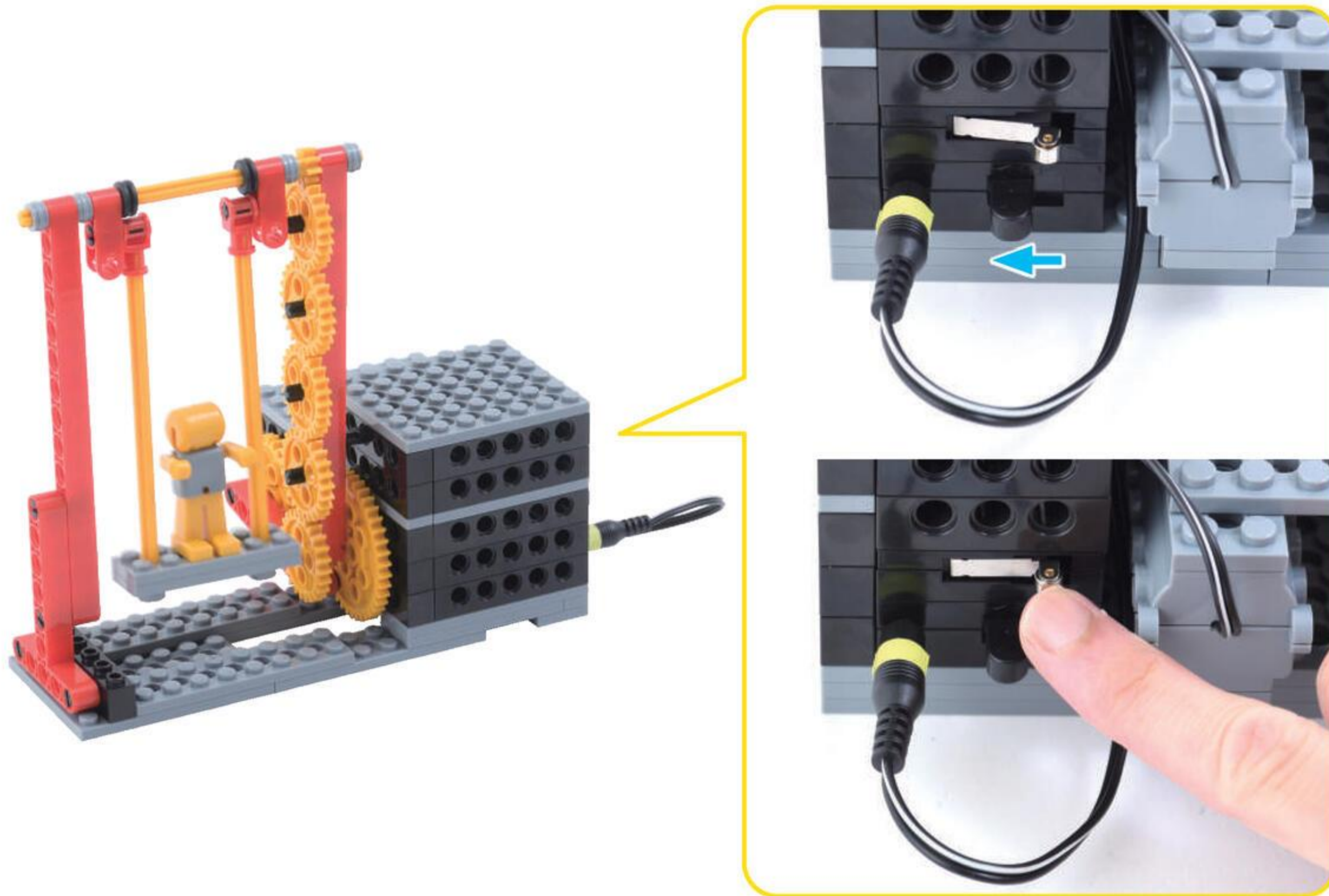

やじるしのむきに ^{すいっち} スイッチをいれて
^{たっちせんさあ} タッチセンサーをおしてみよう!



うごかし おわったら ^{すらいどすいっち} スライドスイッチを まんなかに もどそう

2 あたらしい じめん

めやす 5 ふん

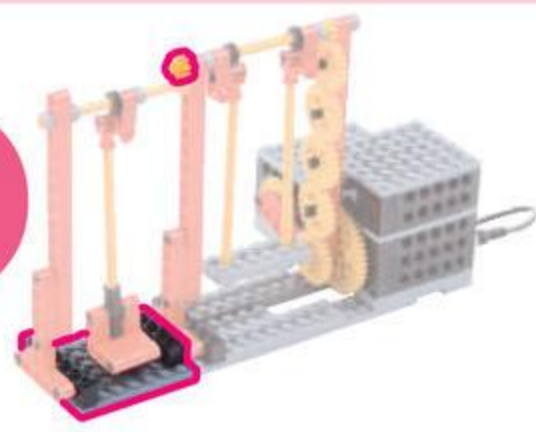

1

はずす

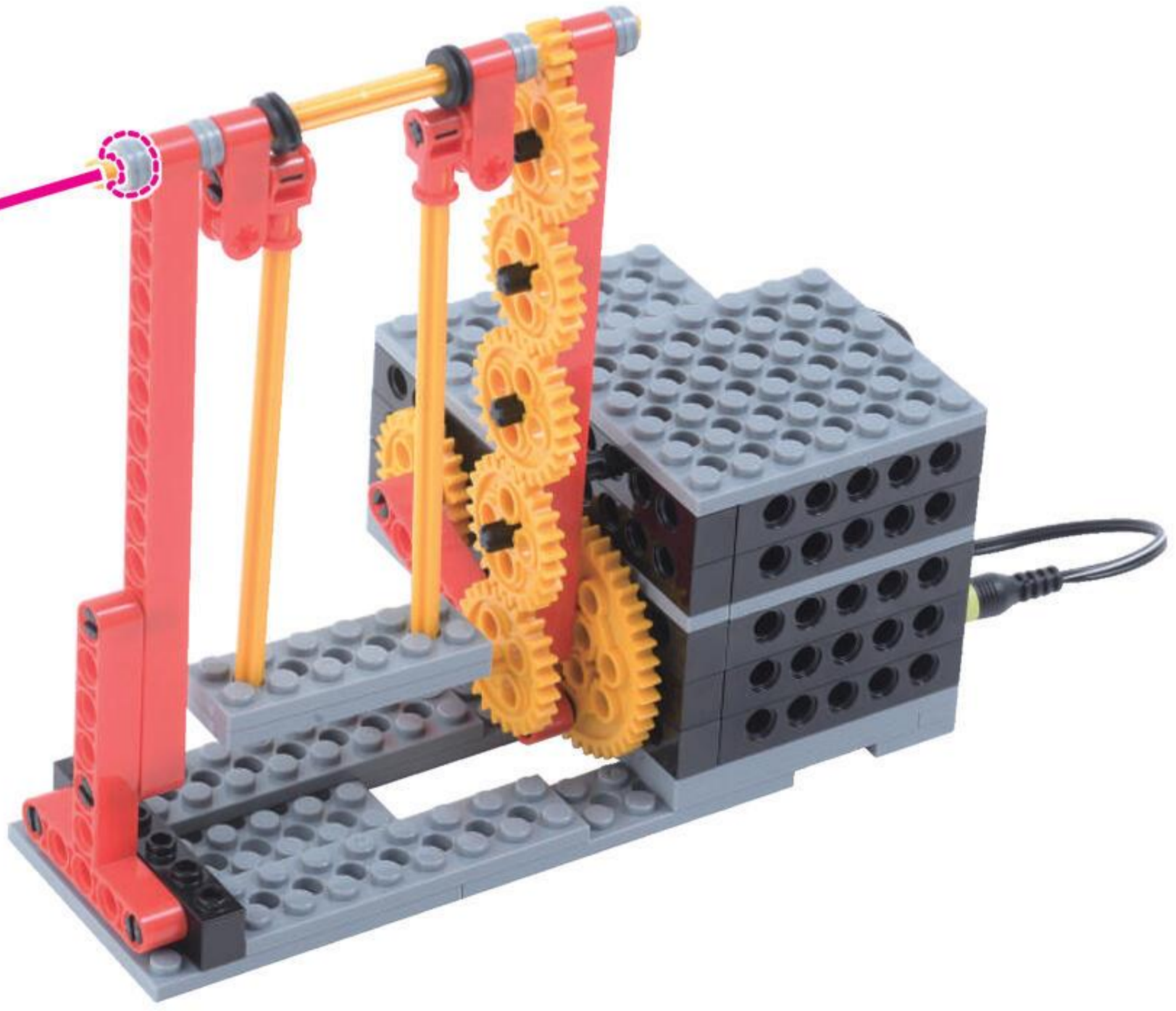

はずした ^{ばあつ} パーツは
しまおう

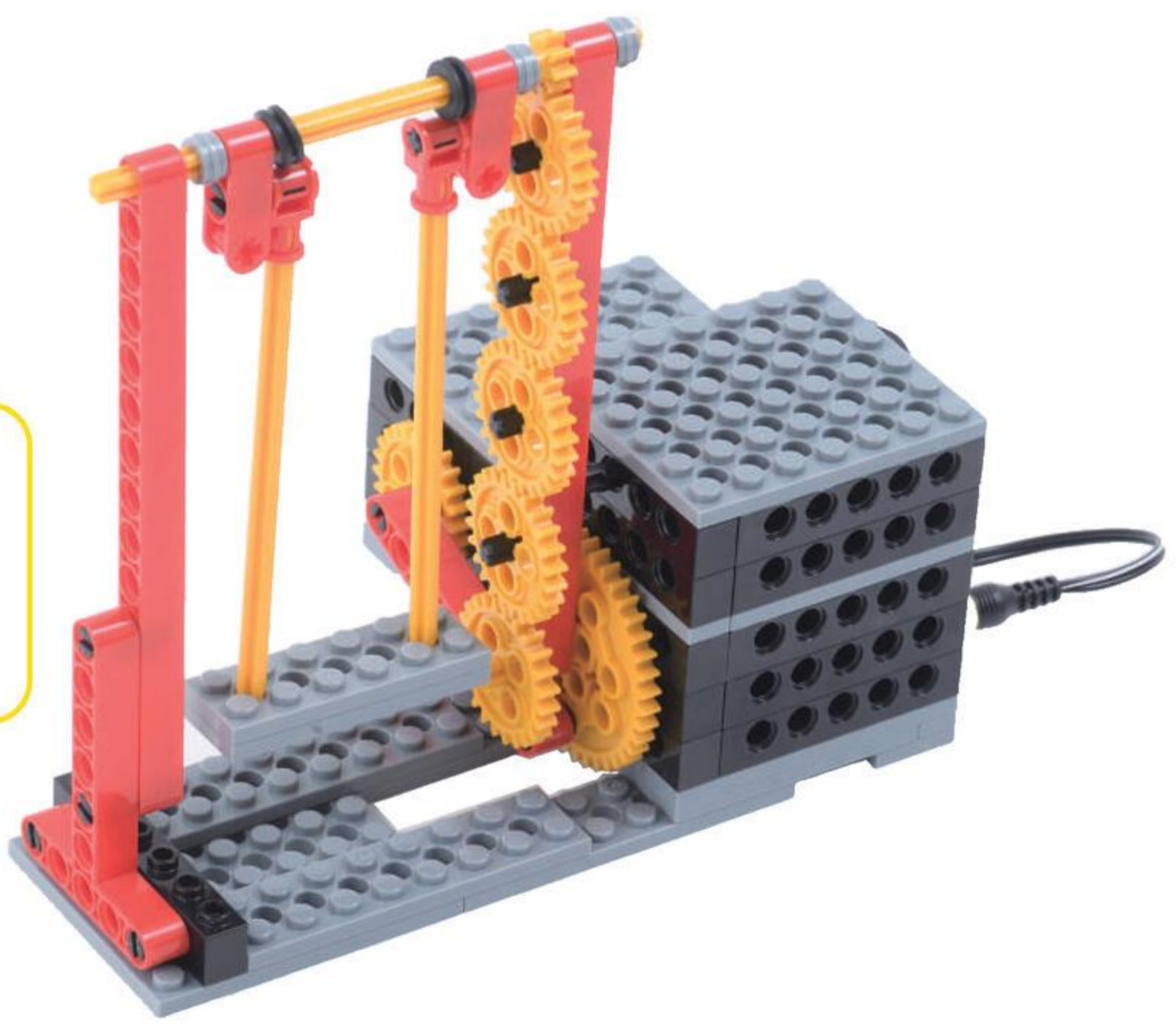

びにおんぎあ
ピニオンギアうす 1こ

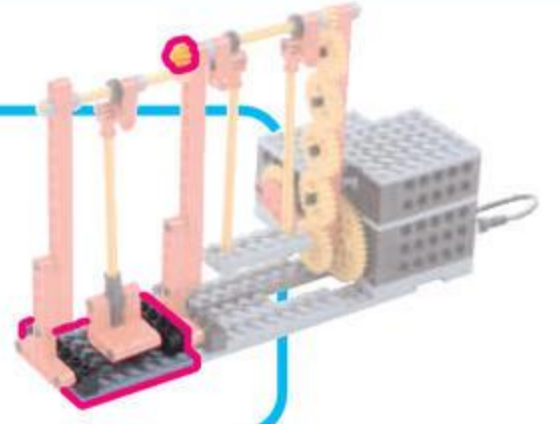

2

むきに ちゅうい



こちらを
さしこむ

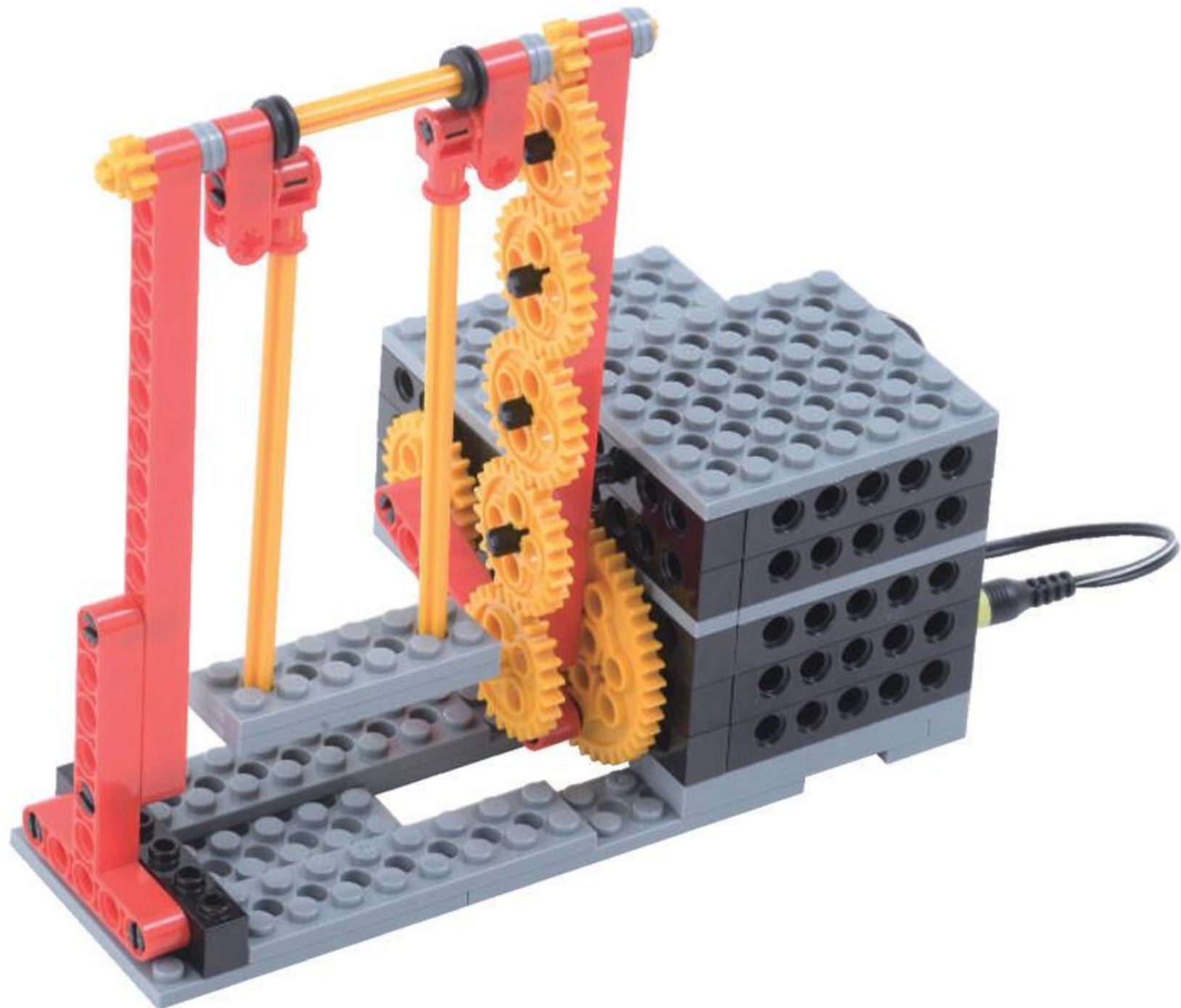
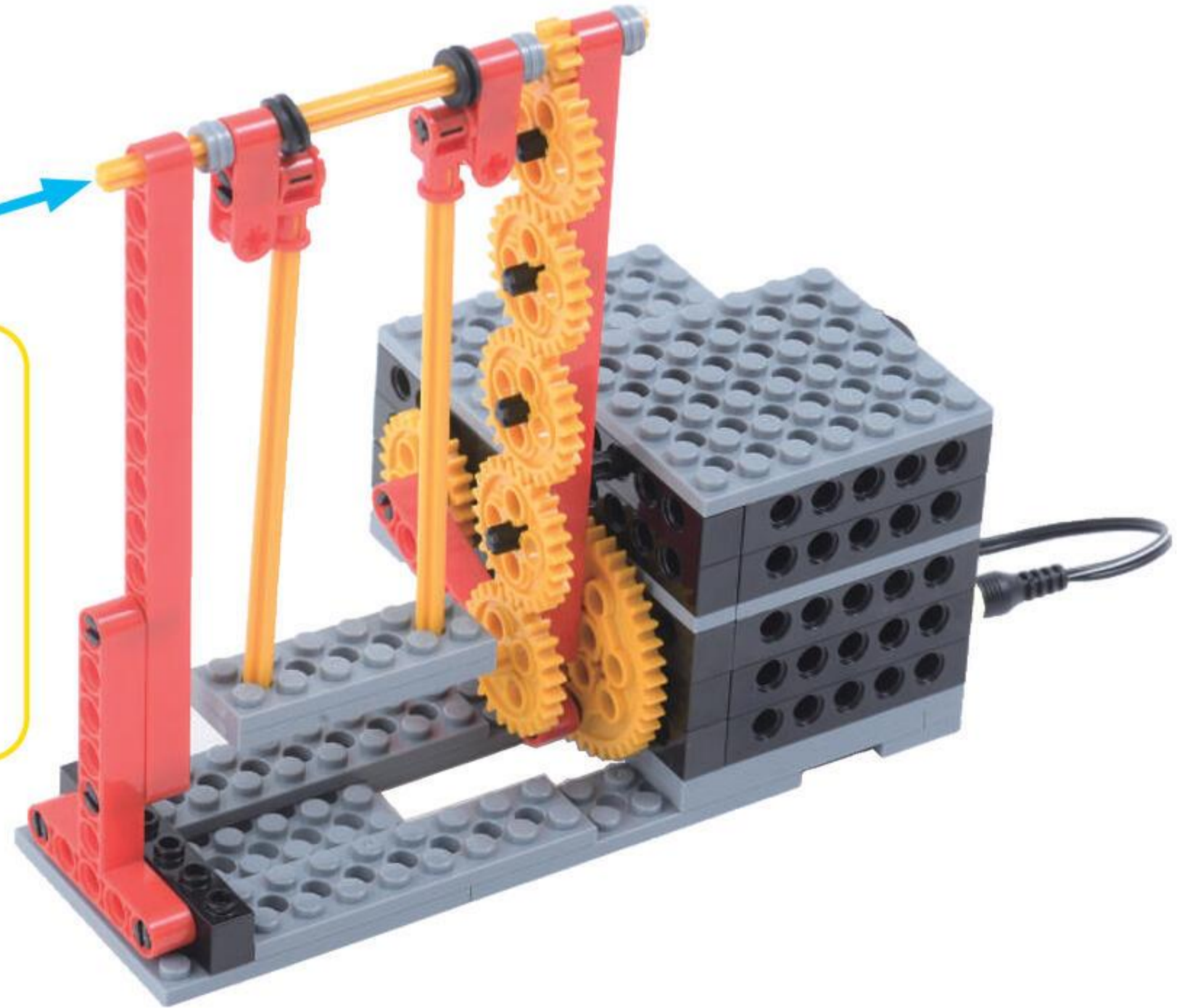

ぶれえとる プレート 1こ

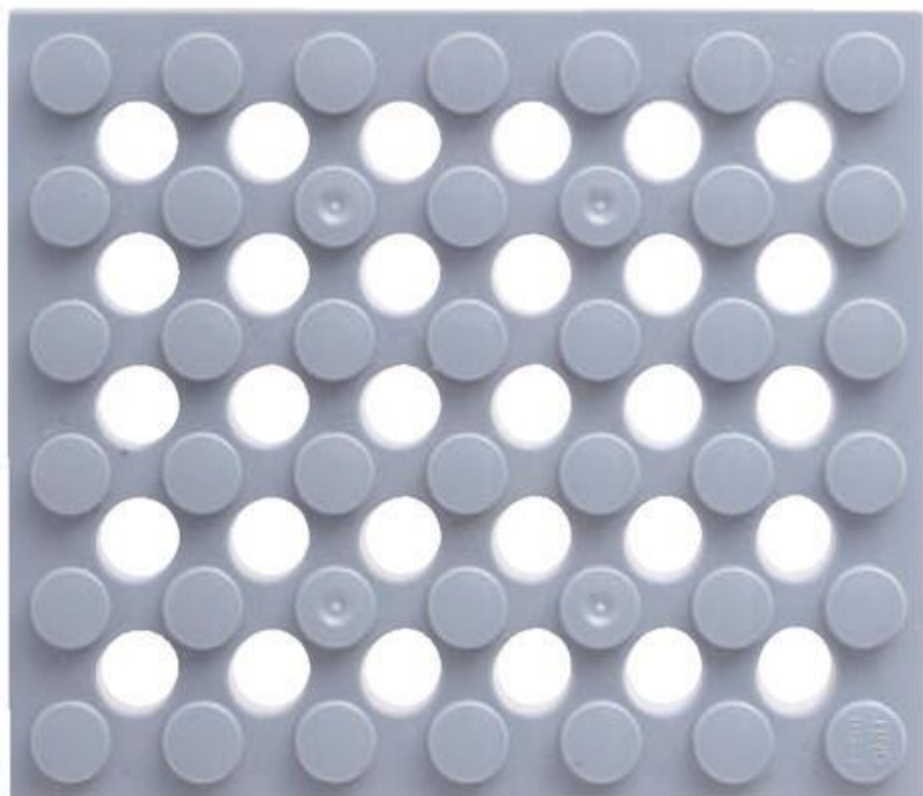

びいむろくほち ビーム 6ポチ 1こ



びいむよんほち ビーム 4ポチ 1こ

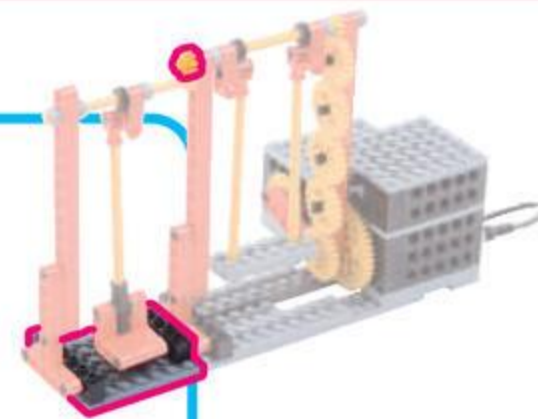

3

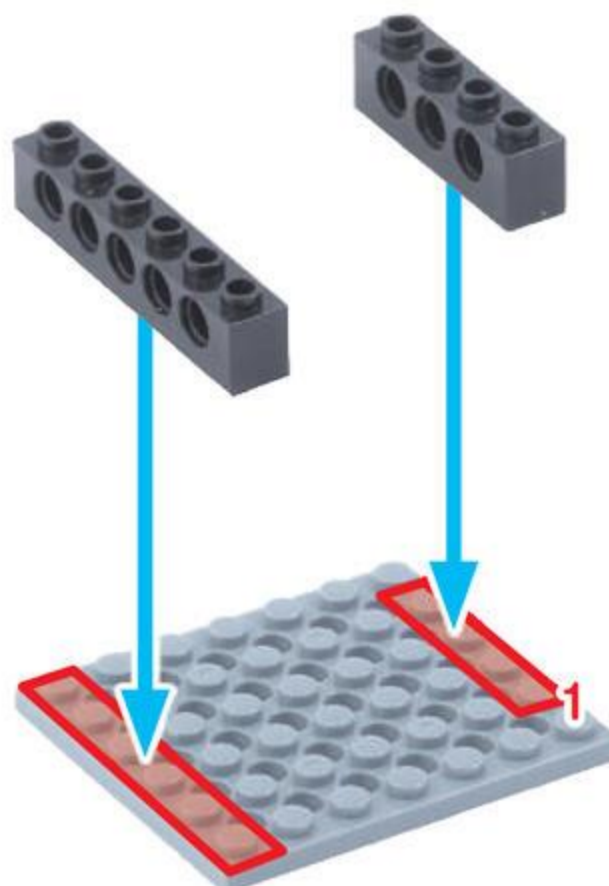

peg 2
peg S 2

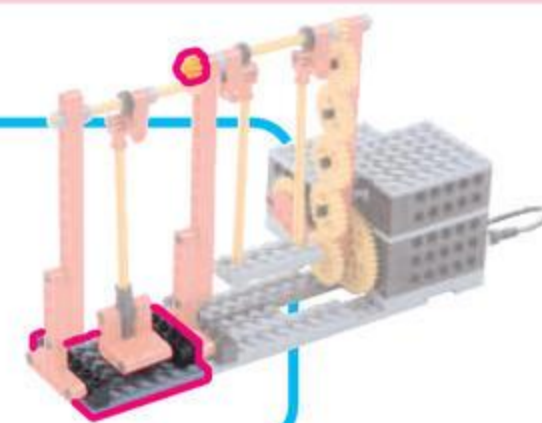

4

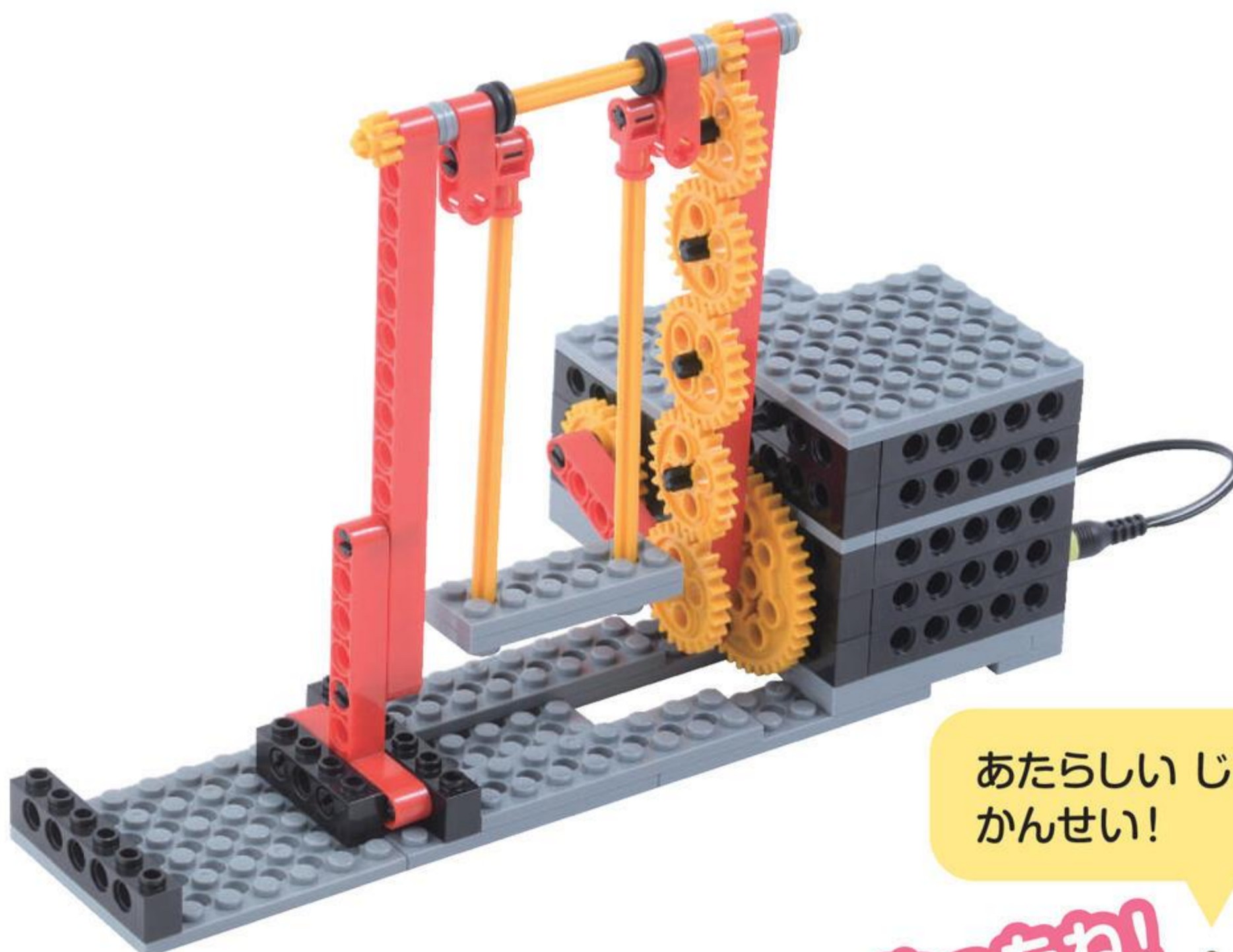
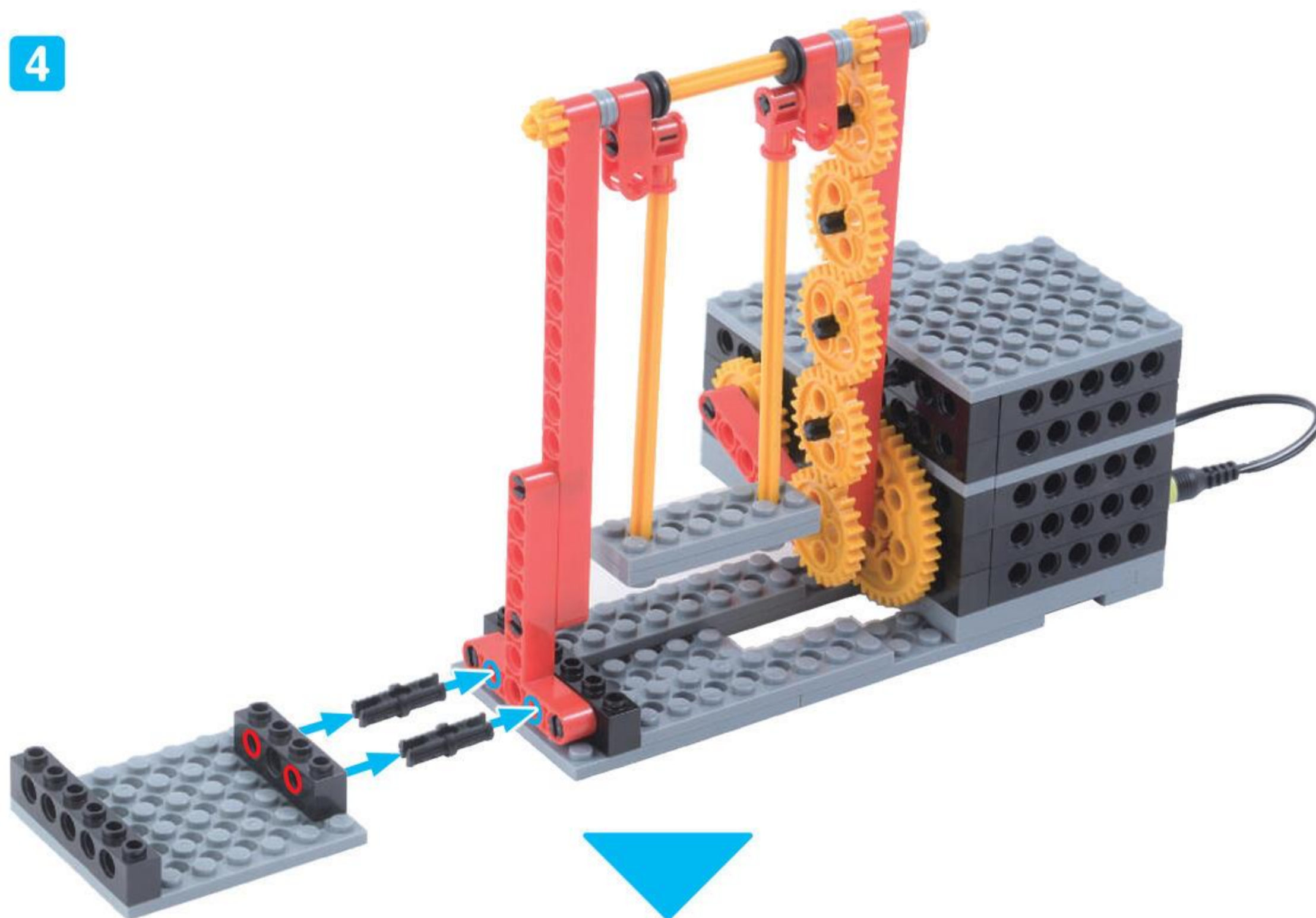

あたらしいじめんが
かんせい!



3 あたらしい ぶらんこ ブランコ

めやす 15 ぶん

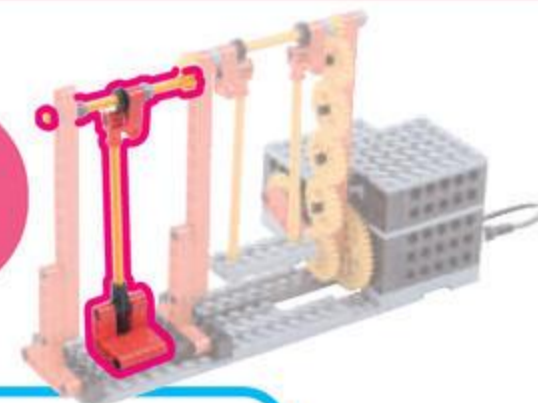

しゃふと じゅう ぽち
シャフト 10 ポチ 1 こ



ながさに
ちゅうい

くろしゃふと いってん ぽち
黒シャフト 1.5 ポチ 1 こ



くろすじょいんと
クロスジョイント 1 こ



○ みじかい

× ながい

あなしゃふと じょいんと
アナシャフトジョイント 1 こ



てい じょいんと
T ジョイント 1 こ



1

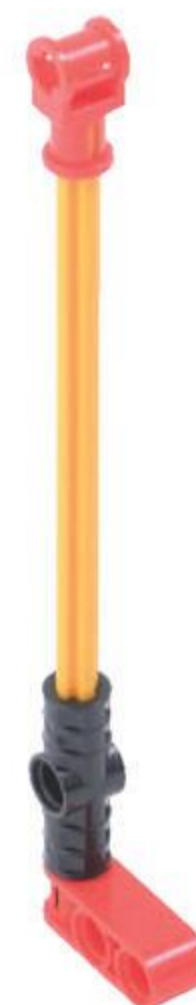

peg 2
peg 2



rod 2
rod 2

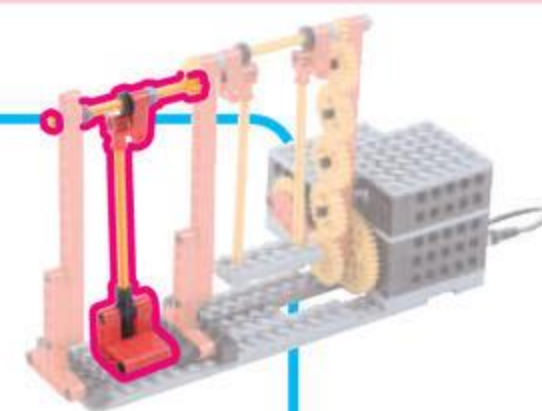

2

short side
long side



short side long side

insert into this side

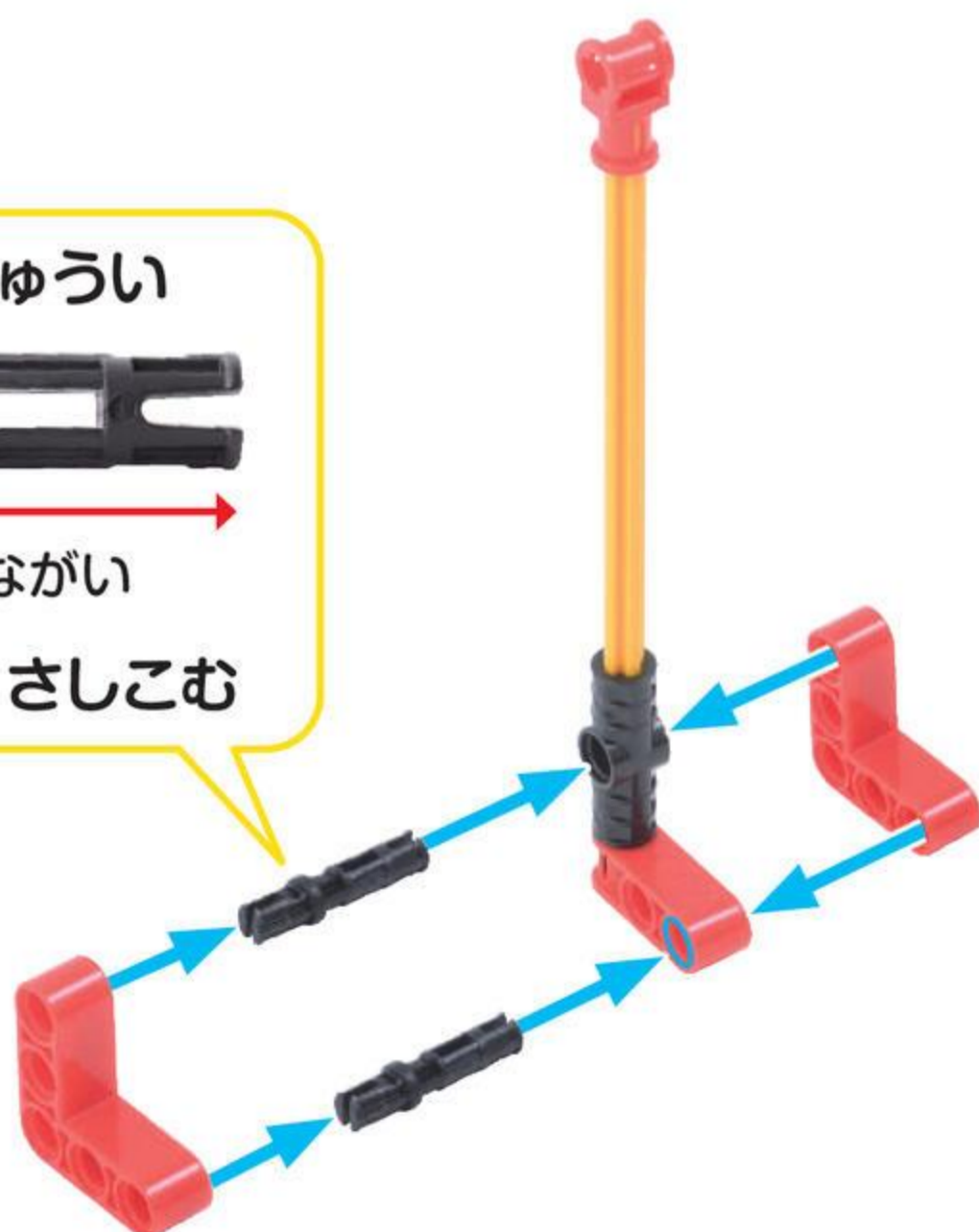

くるすじょいんと **1こ**
クロスジョイント

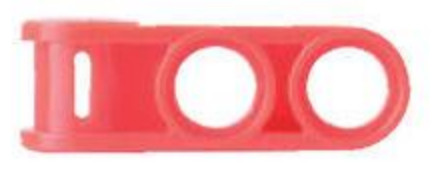

しゃふとペグ **1こ**
シャフトペグ

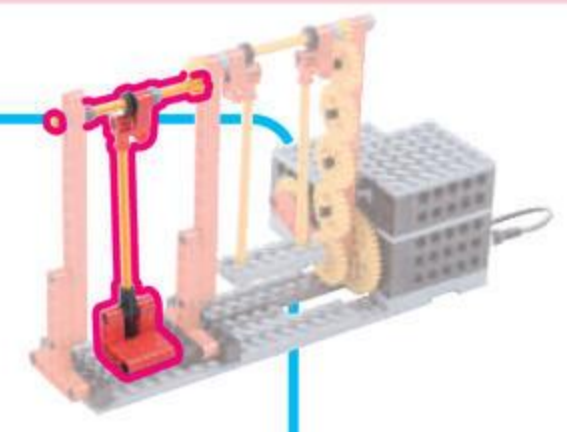
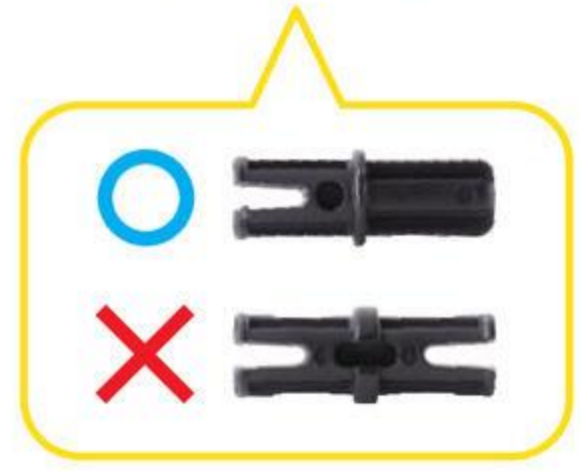

3

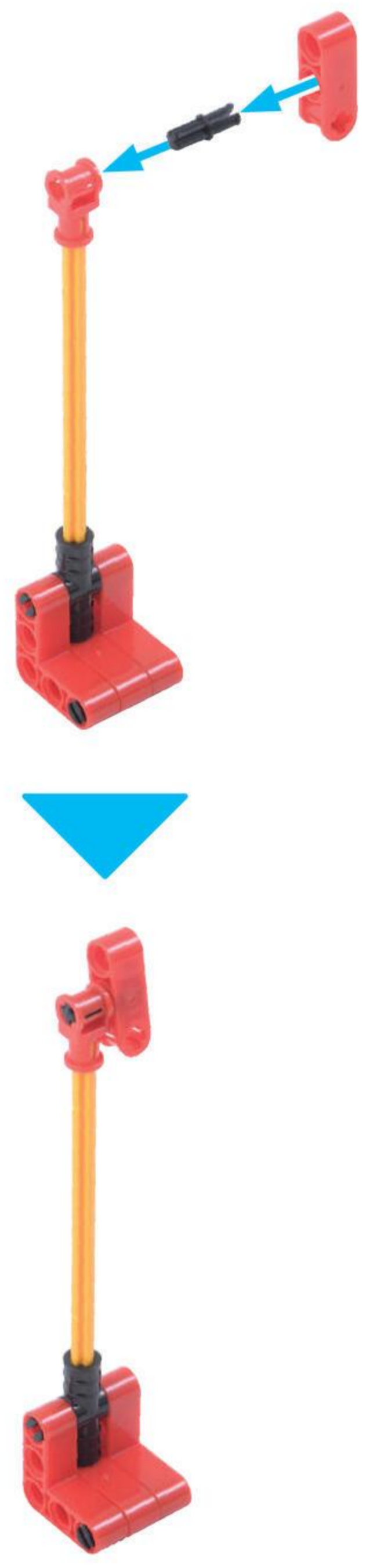

シャフト 10ポチ 1こ



ピニオンギア 1こ



グロメット 1こ



ブッシュ 2こ

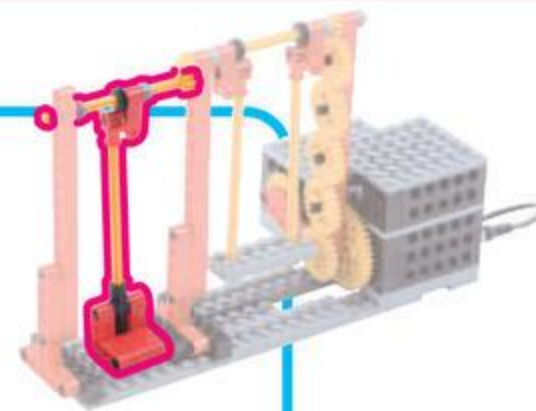

4



むきに ちゅうい



こちらを
さしこむ



5

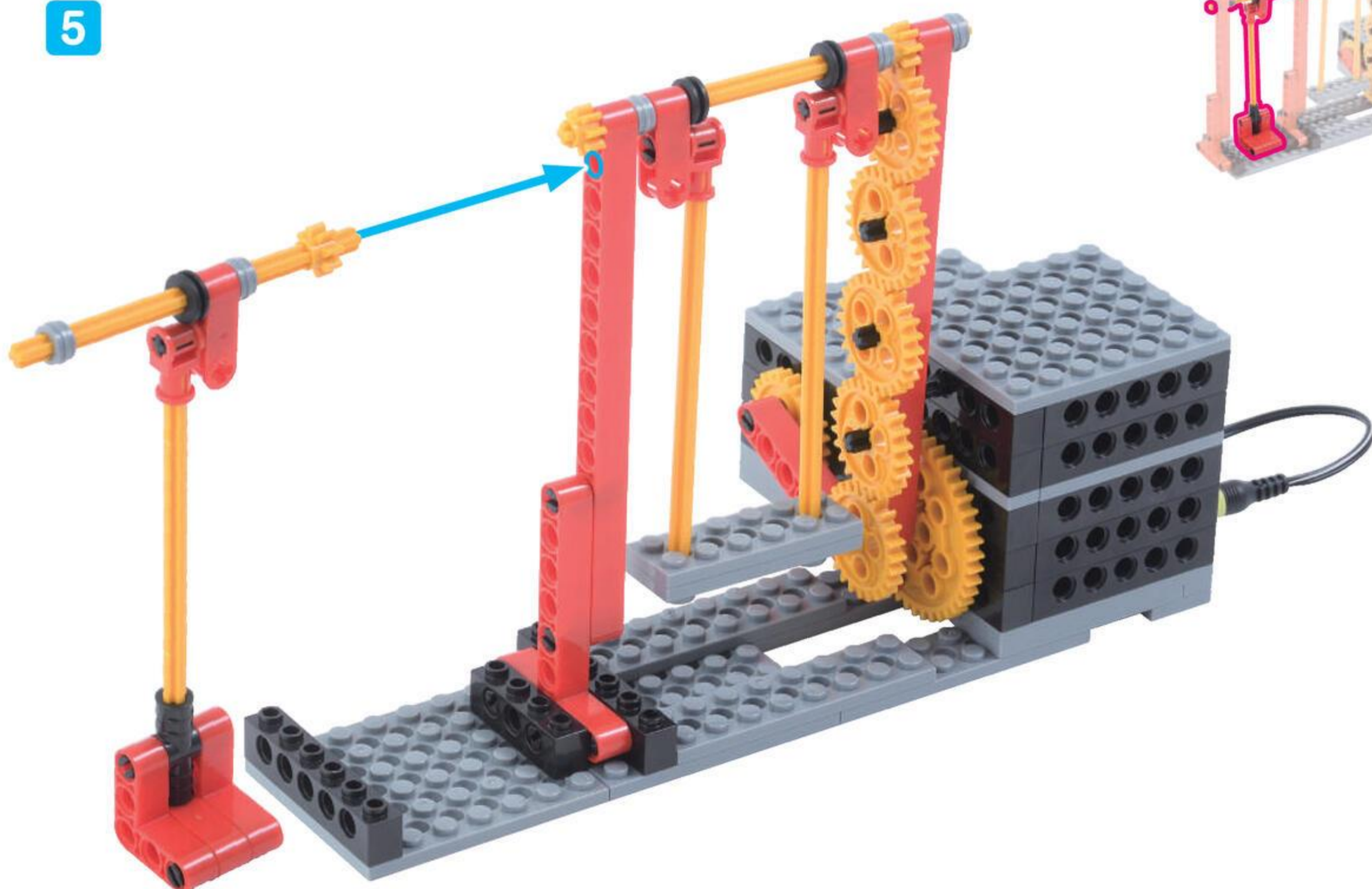

しっかり かみあわせよう

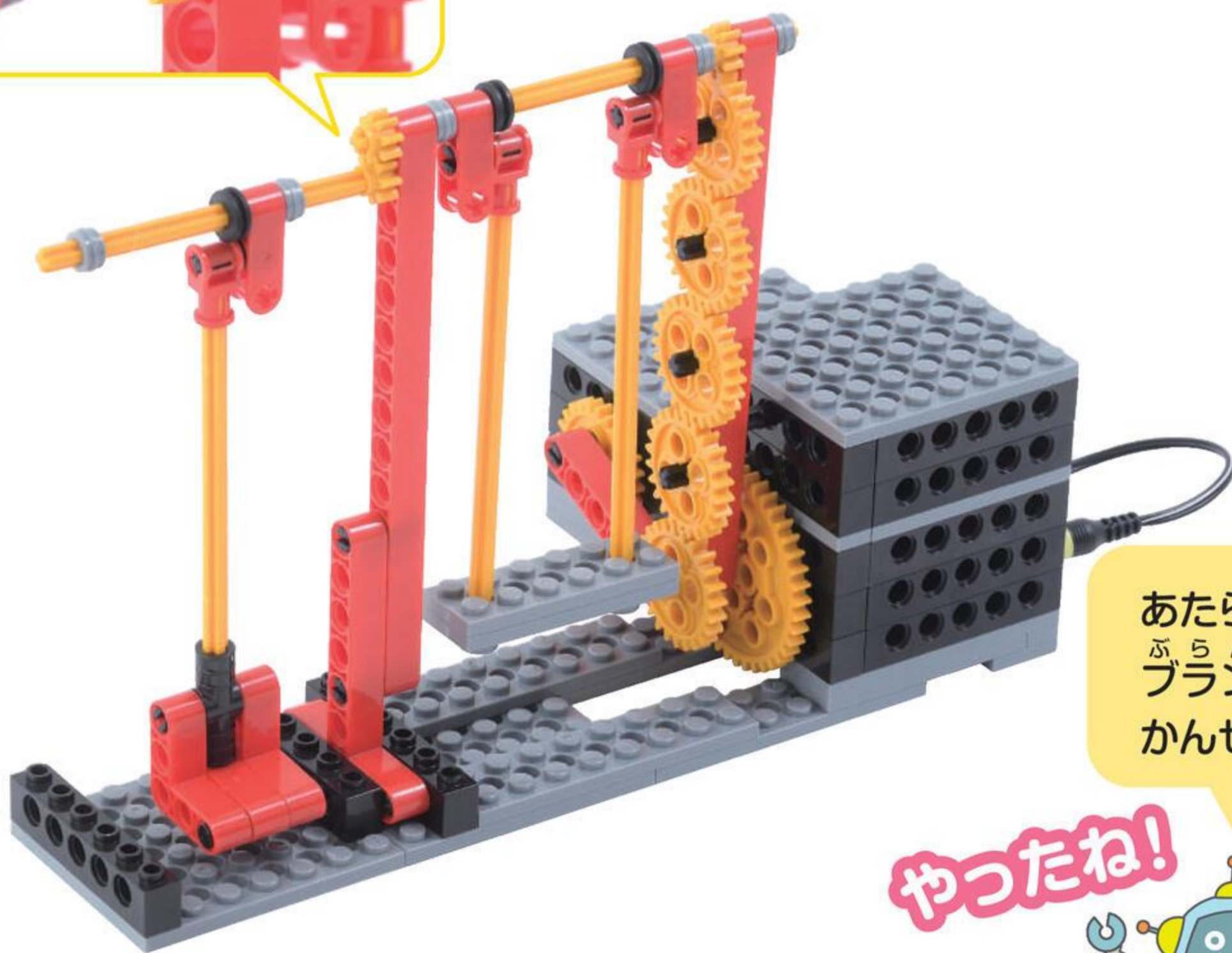

あたらしい
ぶらんこ
が
かんせい!

やったね!

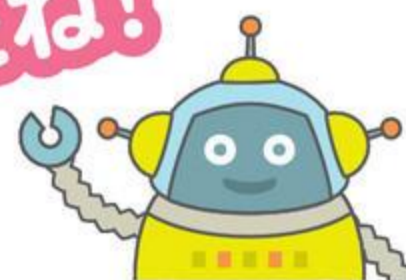

4 あたらしい はしら

めやす 5 ぶん

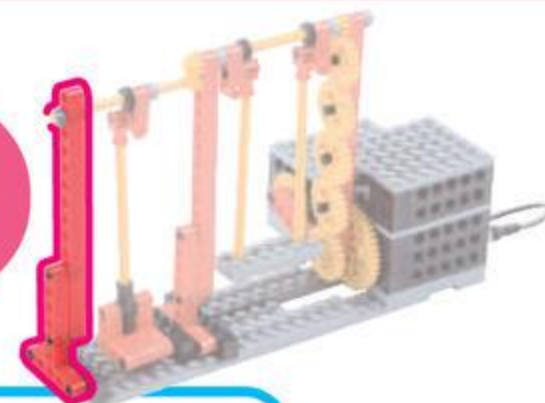

てい るっど
T ロッド 1 こ

ぺぐ えす
ペグ S 4 こ

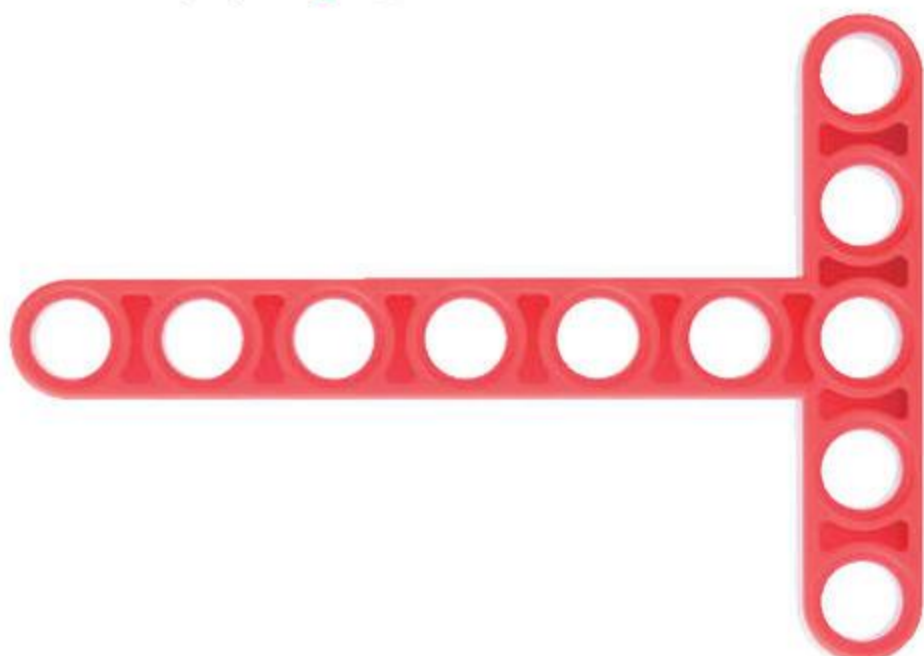

1

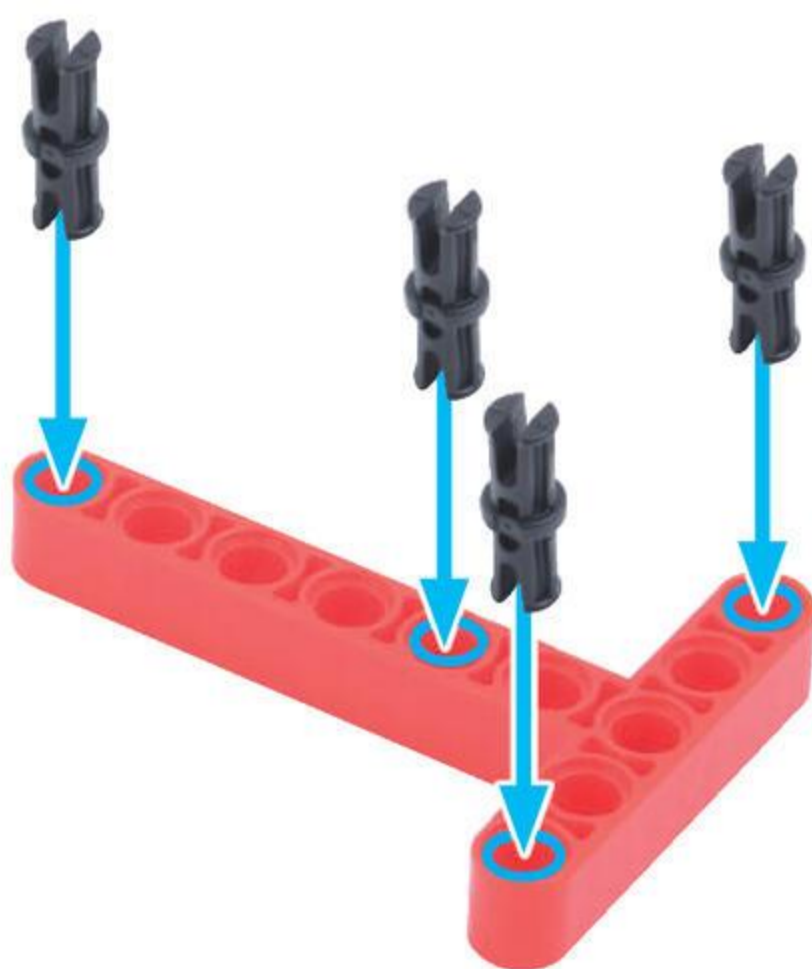

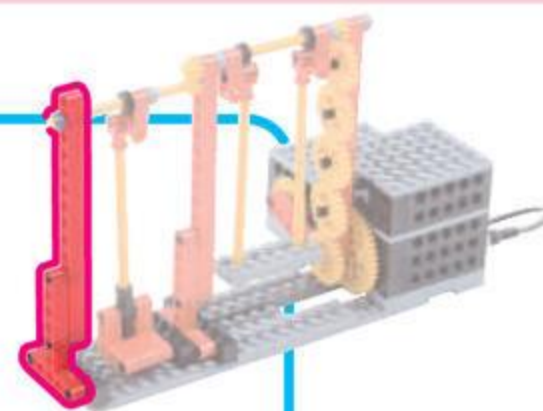

ろっど 15 アナ 1 こ



2

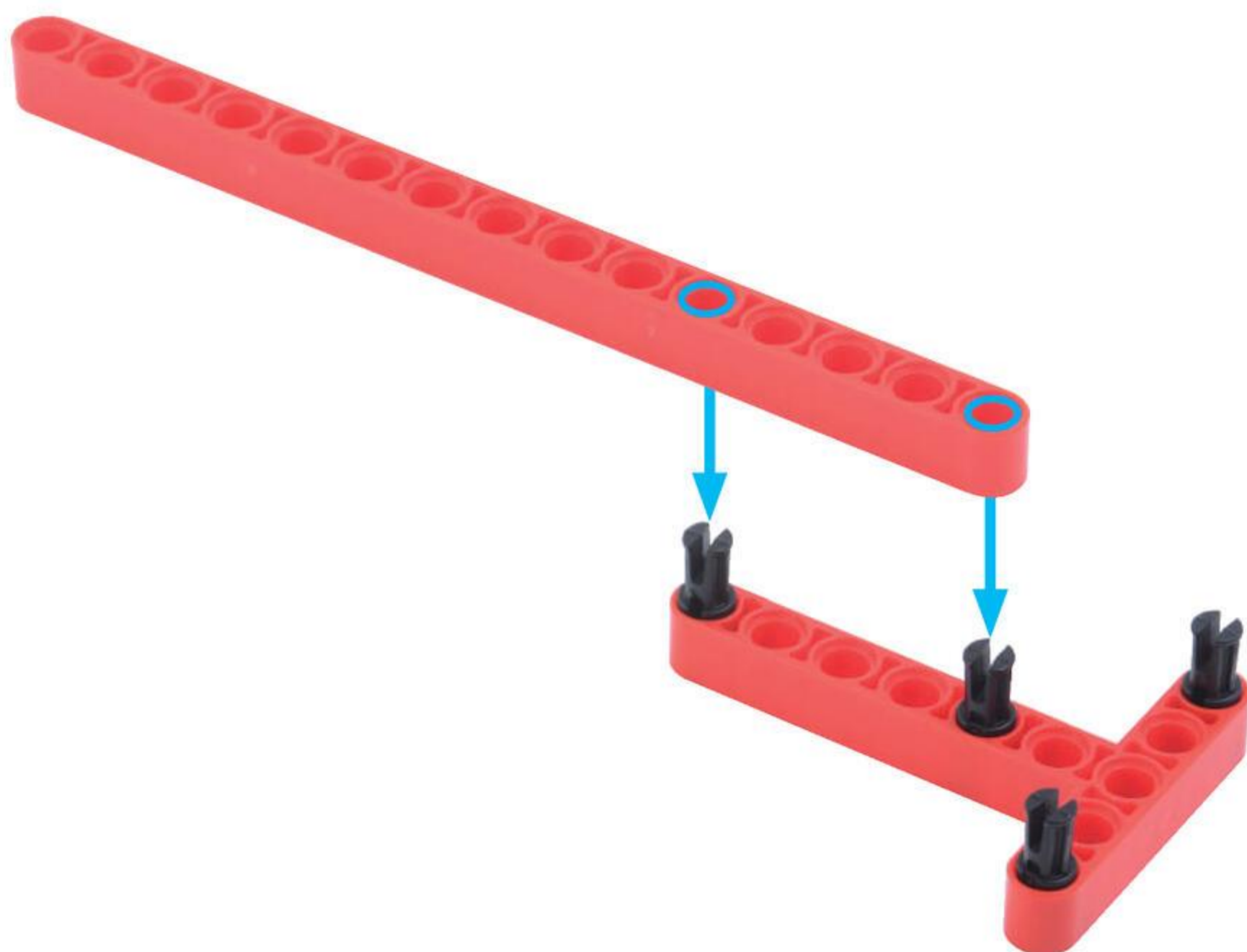

ぶっしゅ 1こ

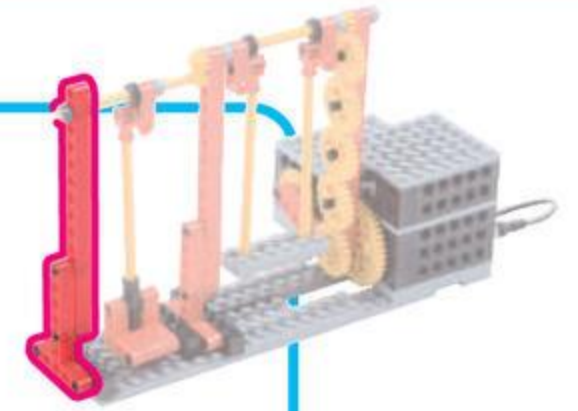

3

あな
アナのいちに
ちゅうい

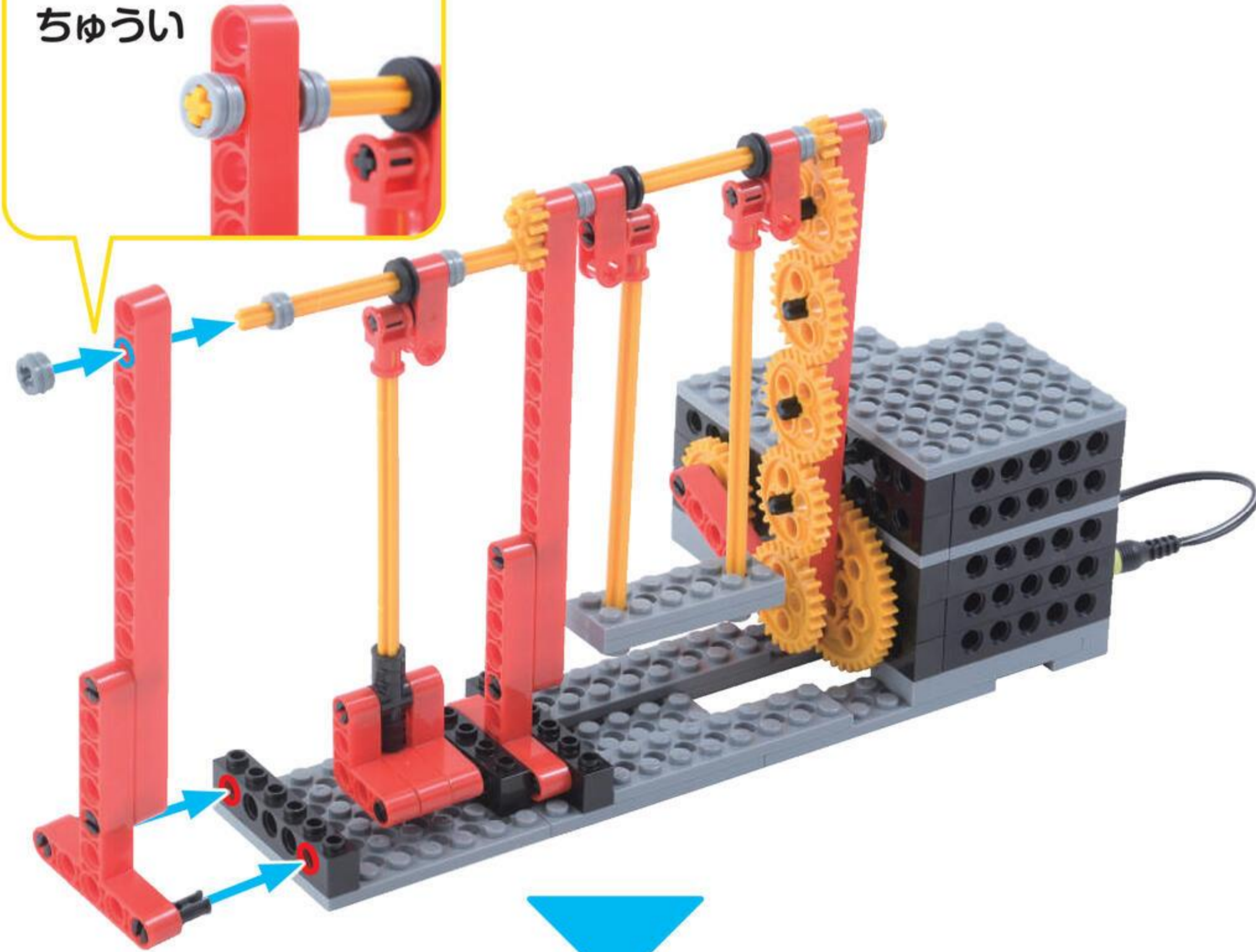

これで
かんせい!

よくできました!

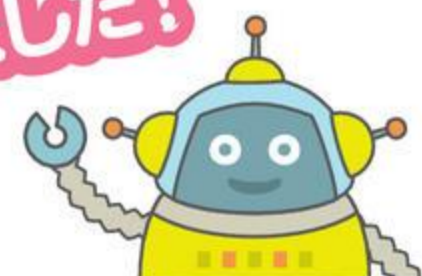

ロボットをうごかそう

めやす 15 ぶん

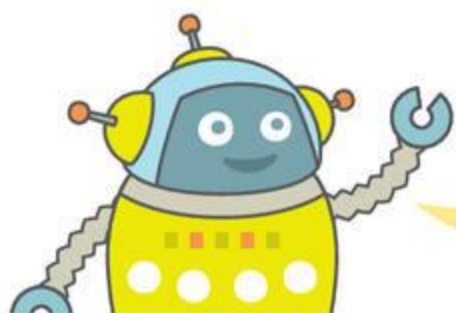
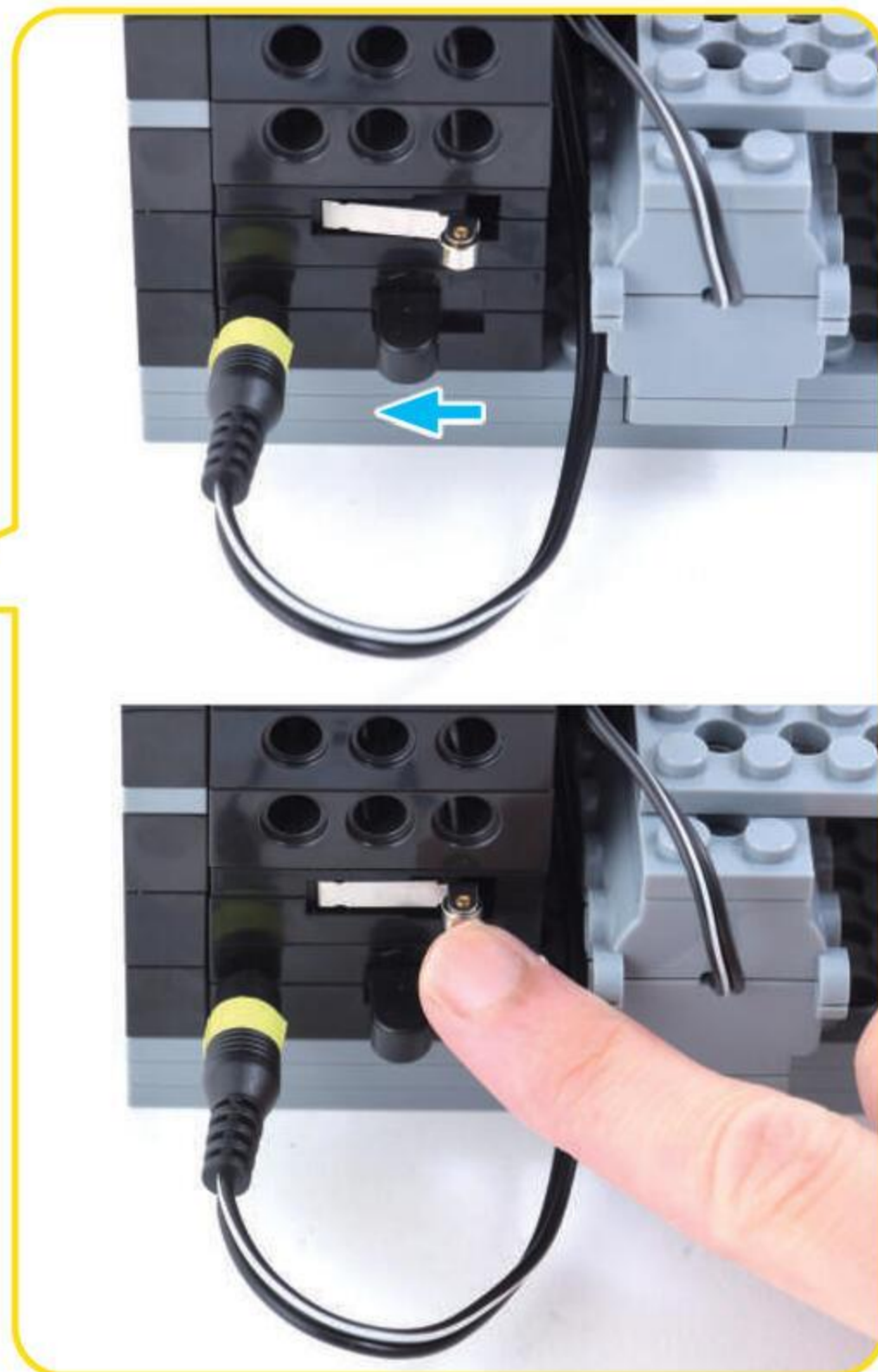

やじるしのむきに ^{すい} ^ち スイッチをいれて
た ^あ ^あ ouchi ouchi センサーをおしてみよう!



じゆうにかいぞうしてみよう

めやす 10 ぶん

ばあつ
パーツをつかって、じゆうにかいぞうしてみよう！

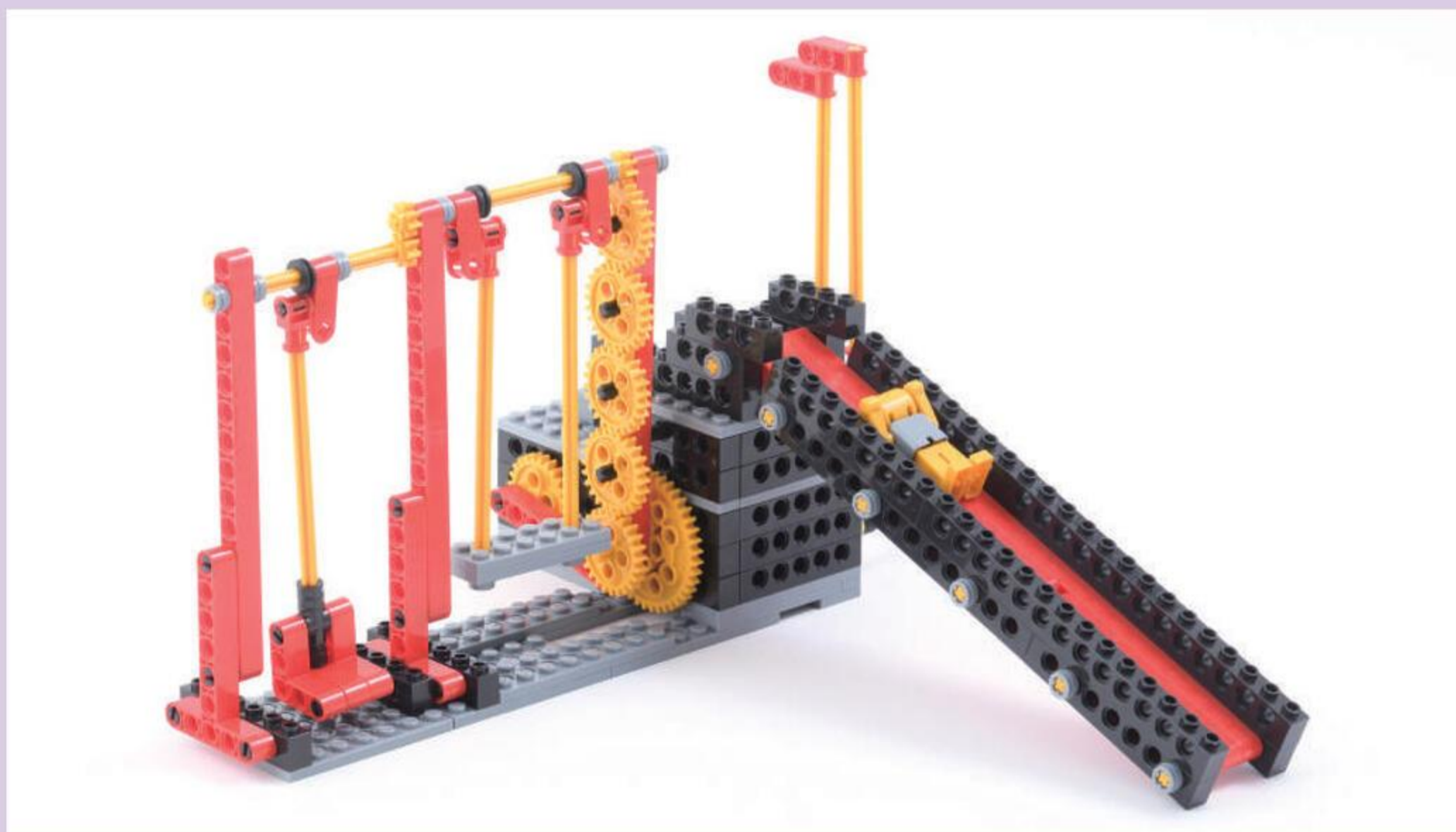

たのしく あそべるように しよう！

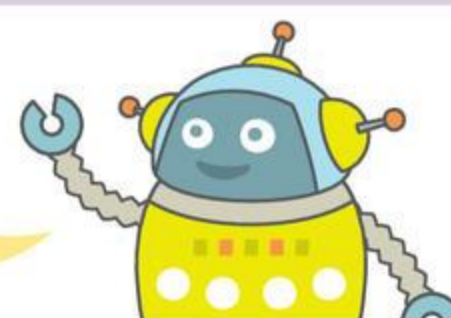

まちがいさがし

めやす 3 ぶん



ちがうところを みつけよう
2つあるよ!

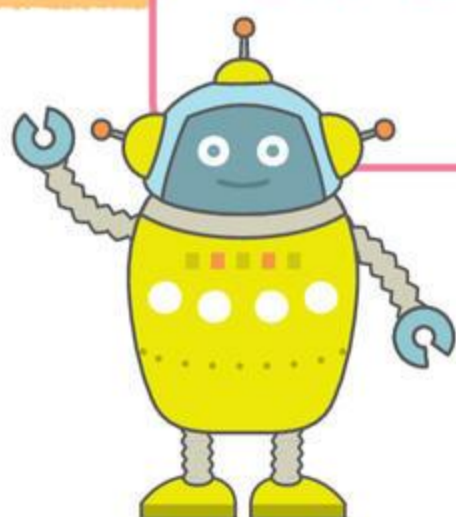



これからつくるロボットを しょうかいするよ

ぶ
れ
ぶ
ら
い
ま
り
い
こ
お
す
プ
レ
プ
ラ
イ
マ
リ
ー
コ
ー
ス

12がっ もってくてく モッテクテク

はいたつ
ロボット



ものはこびながら
まえにすすむロボットだよ

1がっ あるきんぐ アルキング

はっしん!



にそくほこうであるくロボットだよ

2がっ さいころん サイコロん

いっしょに
あそんで

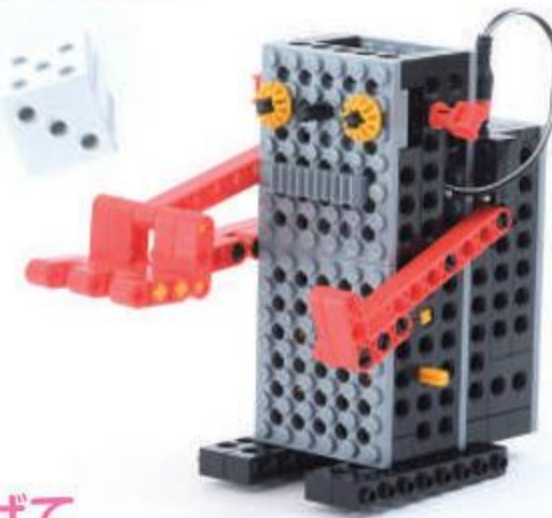

さいころをなげて
すころくであそべるロボットだよ

3がっ ろぼこんぐ ロボコング

ゴリラがた
ロボット



どんなふうにあるくのか、
おたのしみに!

ぶ
ら
い
ま
り
い
こ
お
す
プ
ラ
イ
マ
リ
ー
コ
ー
ス

12がっ あるぺんくん アルペンくん

すきいろぼつと
スキーロボット



1がっ ろぼだっく ロボダック

ぺたぺた
こうしん



進級したら

みんな、もらえる!



プライマリー
コース



ベーシック
コース



ミドル
コース



アドバンス
コース

- コースを進級された方用に、修了証とパイロットをお送りします。
- 2024年10月以降に進級された方へご提供いたします。

※画像はイメージです。実際のものとは異なる場合があります。
※「パイロット/修了証」のカラーは、進級コースによって異なります。

SNSアカウント

フォローお願いします!



@human_junior



ヒューマンアカデミー
こどもちゃんねる



ヒューマンアカデミー
ジュニア



@human_CECoe