



Human

ヒューマンアカデミー ジュニア



ロボット教室

# ロボットのきょうかしよ

プレプライマリーコースⅡ

1

のって はして「き っ く ほ お だ あキックボダー」

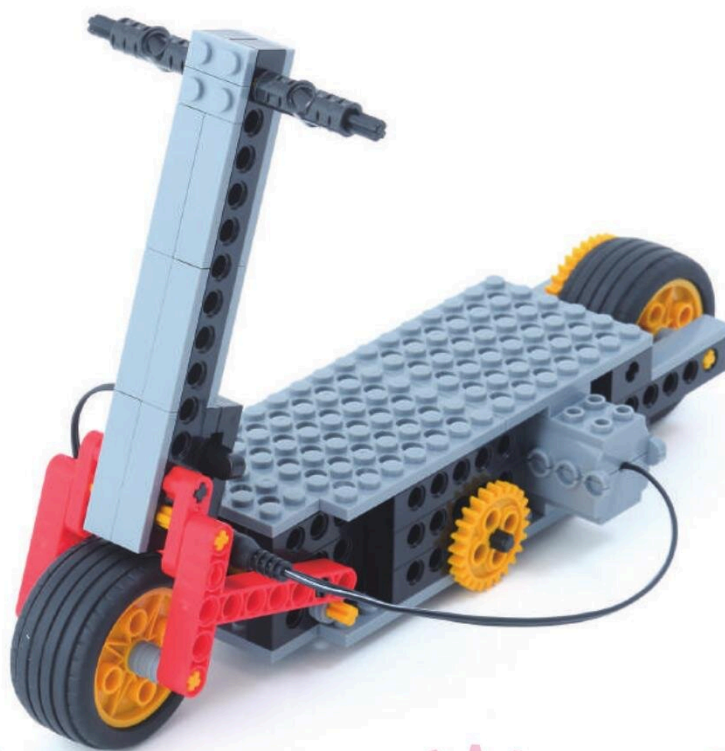

★だい1かい

2025ねん

4がつ

にち

なまえ

## ちゅうい しょう

ばあっ パーツや でんきぶひんを あんぜんにつかうために

### ! パーツを くちに いれない

くみたてた パーツを とりはずすときは、  
ぜったいにはをつかてはいけません。  
ばあっ パーツを のみこんでは いけません。

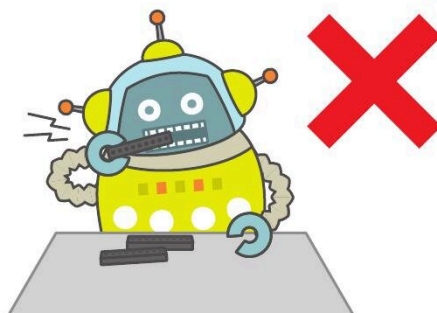

### ! ぶひんを きずつけない

でんきぶひんを はさみや カッターなどで  
きずついたり、パーツで はさんだりしては  
いけません (しゃしん 1)。

こおど や けえぶる コードや ケーブルは、おりまげたり、  
ひっぱたりしては いけません。

ぶらぐ の めきさしは、ぶらぐぶぶんを  
もって おこないましょう (しゃしん 2)。

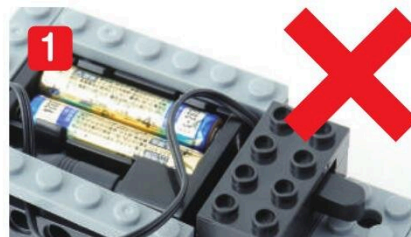

### ! あつい・におうとき、へんなおとが するとき

ろぼっと ロボットを うごかしたときに、でんちや でんきぶひんが  
あつくなったり、へんなにおいがしたり、いつもとちがうおとが  
したばあいは、すぐに ろぼっと ロボットをとめ、せんせいに しらせましょう。  
ぬれたてで でんきぶひんを さわっては いけません。

もくじ

だい 1 かい

ロボット の ぶんかい	3	10ぶん
かんがえてみよう	3~4	12ぶん
きょうの パーツ	5	
きょうの よてい	6	
くみたて		60ぶん
1. ボード	7~26	
ロボットを うごかさう	27	
くみたて		
2. ハンドル	28~34	
3. ストッパー	35~38	
4. ぜんりん	39~41	
ロボットを うごかさう	42~43	
クイズ	44	3ぶん
かたづけ		5ぶん

ぶろっくはずし



つかうと べんりだよ

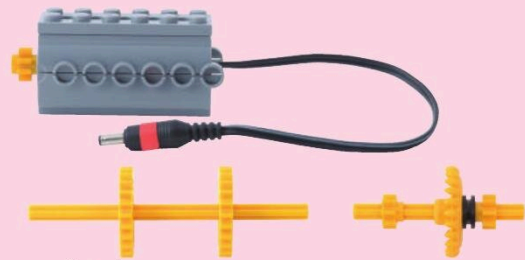

このセットは くずさないでね! またつかうよ



かんがえてみよう

めやす 5 ぶん



キックボードを

みたことが

あるかな?

どんな かたちを

していたかな?





き っ く ほ お ど は す け え と ほ お ど に  
キックボードは スケートボードに  
は ん ど る  
ハンドルがついた のりものだね

す け え と ほ お ど  
スケートボード



と

は ん ど る  
ハンドル

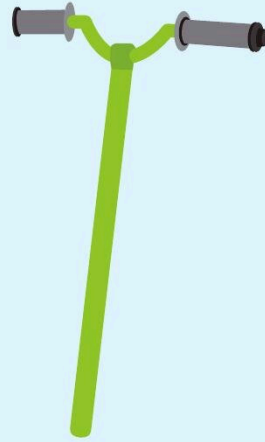

が

がついて

き っ く ほ お ど  
キックボード



になったよ!





めやす **5** ふん

# いろいろな ぎあ ギア

## パーツを ばあつ みつけよう

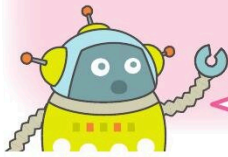

いろいろな おおきさがあるね

### まず またあ たあ

まんなかの しゃふと あなに シャフトの かたちをした ばあつ パーツを させるよ



びいむ ビームにとりつけるとくるくるまわせるよ!



となりの ぎあ ギアにも  
うごきがつたわるよ!

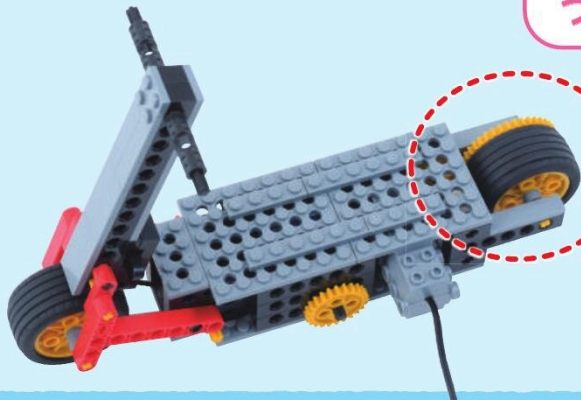

ここで つかうよ つかうよ

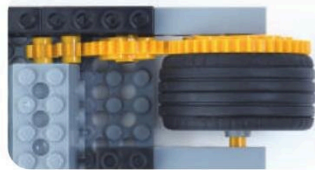

# きょうの よてい

めやす 2 ふん

この じゅんばんで つくるよ！

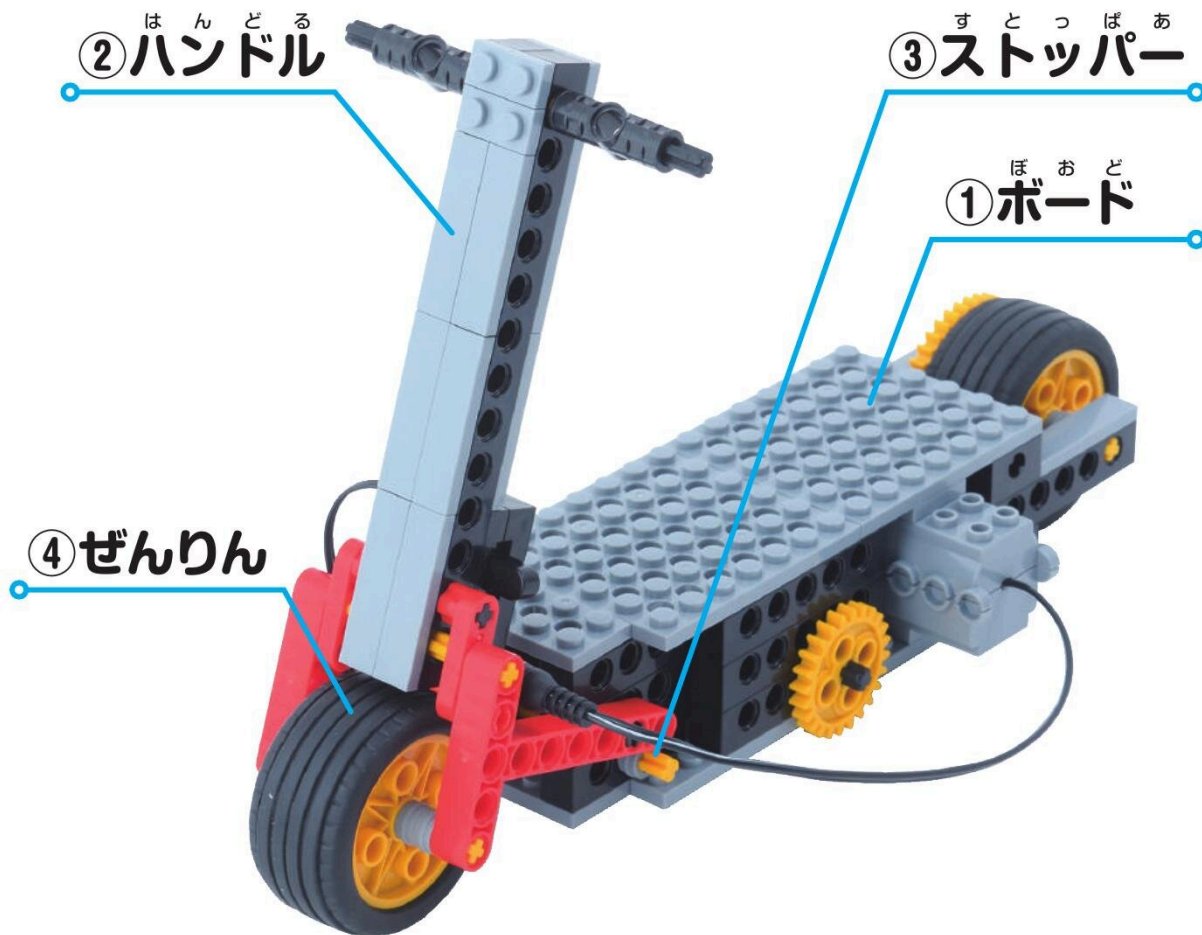

① <sup>ほ お ど</sup> ボード



② <sup>は ん ど る</sup> ハンドル



③ <sup>す と っ ば あ</sup> ストッパー

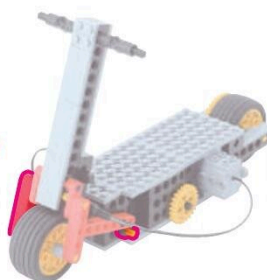

④ <sup>ぜ ん り ん</sup> ぜんりん





1 **ほ お ど**  
**ボード** めやす 30 ぶん

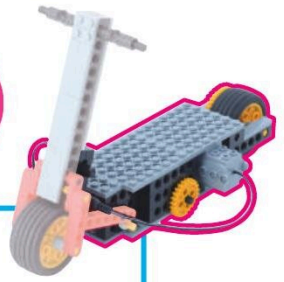

びいむ ほち ぽち  
ビーム 8 ポチ 1 こ



びいむ ゃん ほち  
ビーム 4 ポチ 1 こ



たいる  
タイル 1 こ



びいむ じゅうん ほち  
ビーム 14 ポチ 1 こ



びいむ に ほち  
ビーム 2 ポチ 1 こ

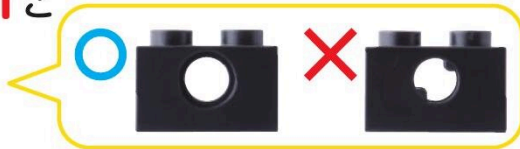

1

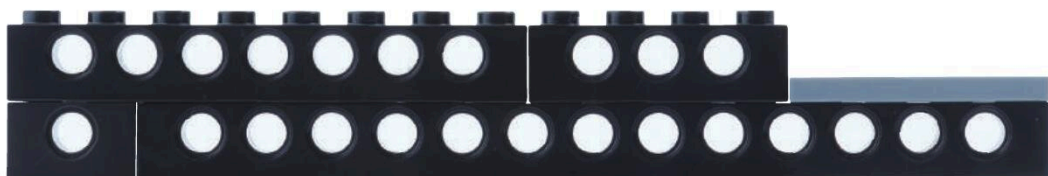
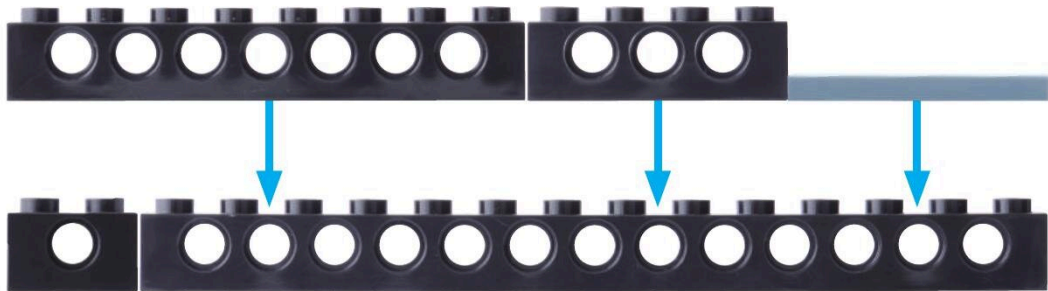



1 プレプライマリーコース 4がつ

びいむはちほち  
ビーム 8 ポチ 1こ



びいむよんほち  
ビーム 4 ポチ 1こ



2

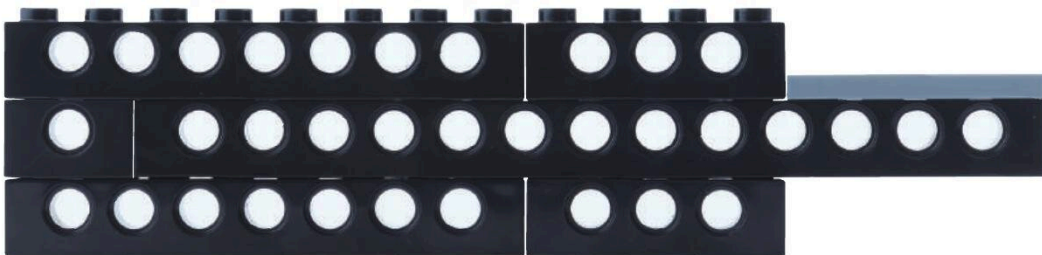
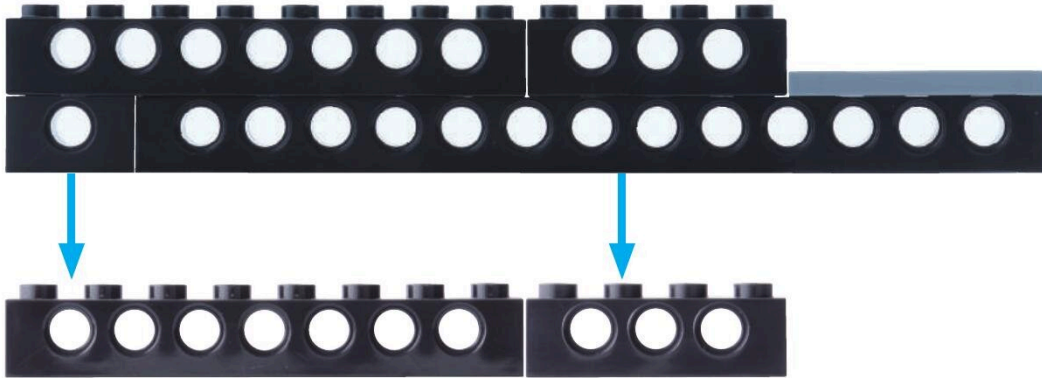

びにおんぎあ **1こ**  
ピニオンギア

ぎあえむ **1こ**  
ギア M

しゃふとぺぐ **2こ**  
シャフトペグ

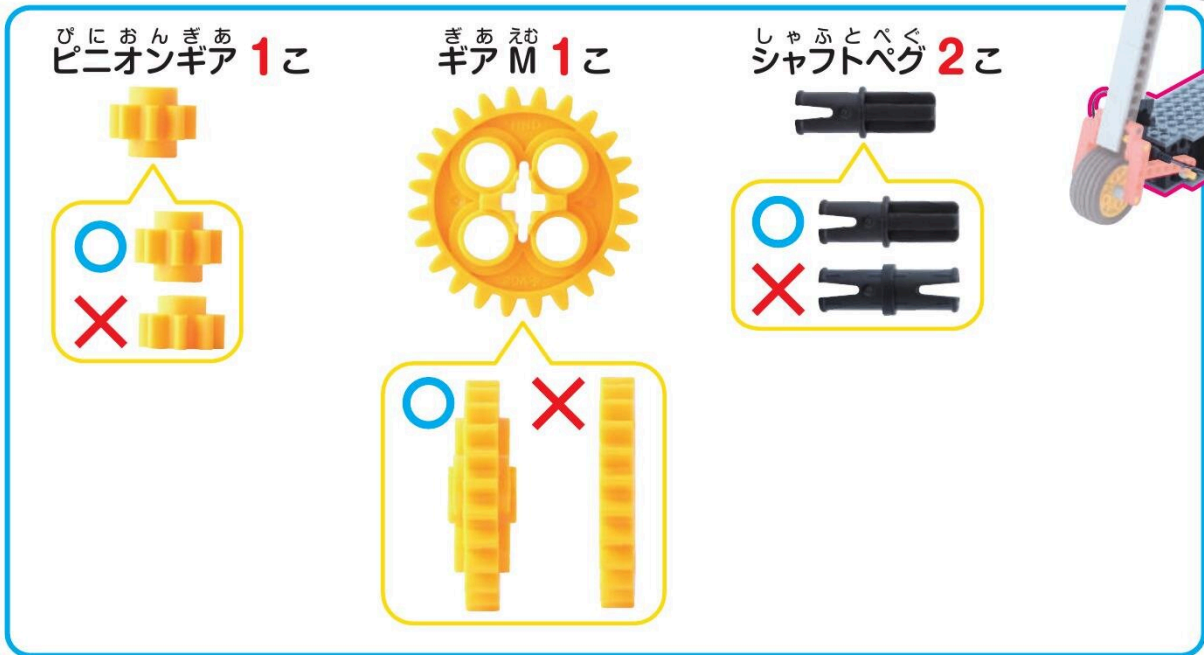

3



4

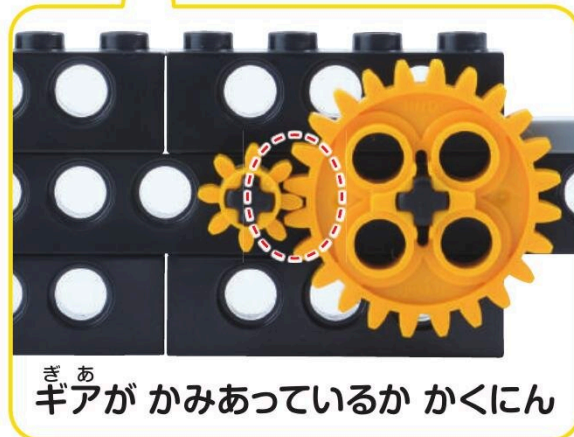
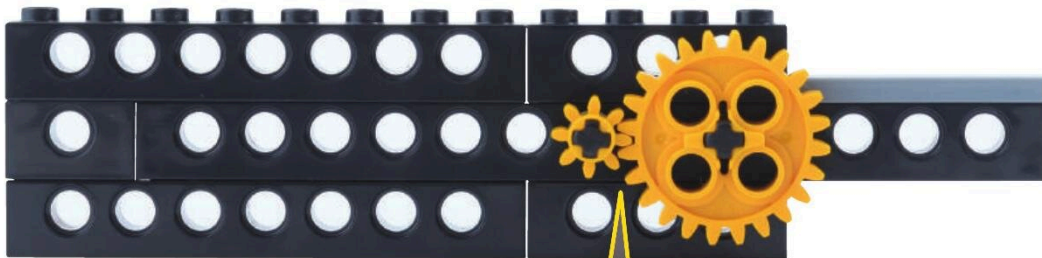
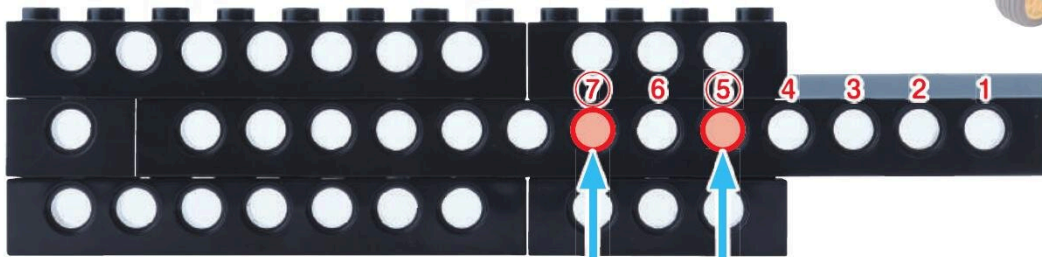



ふれえとろ  
プレートL 2こ

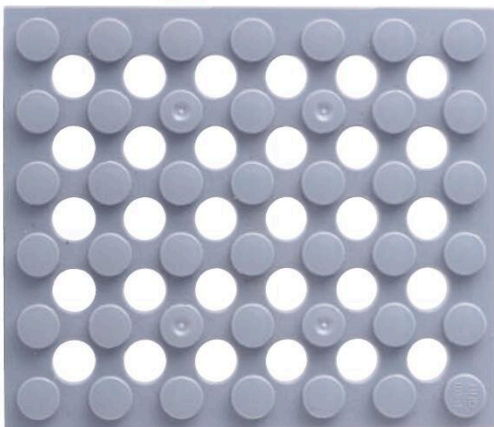

ふとふれえとゆほち  
太プレート4ポチ 1こ



5

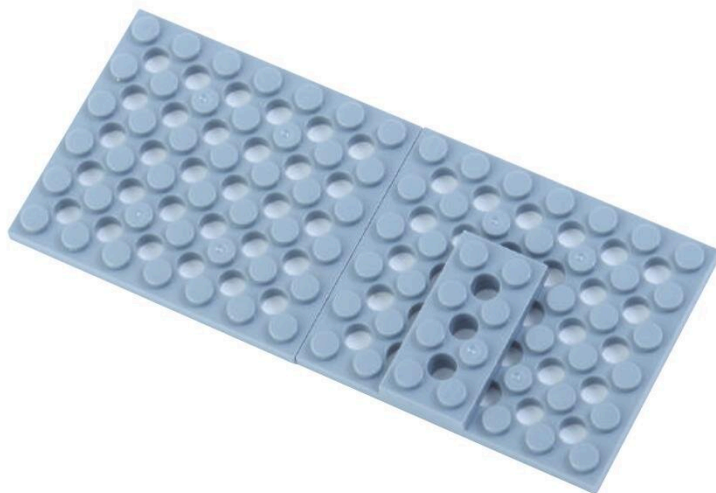
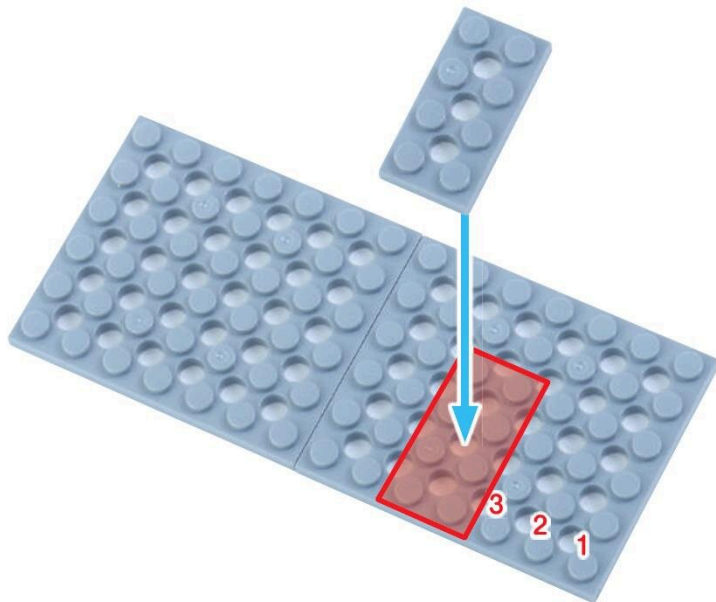

6

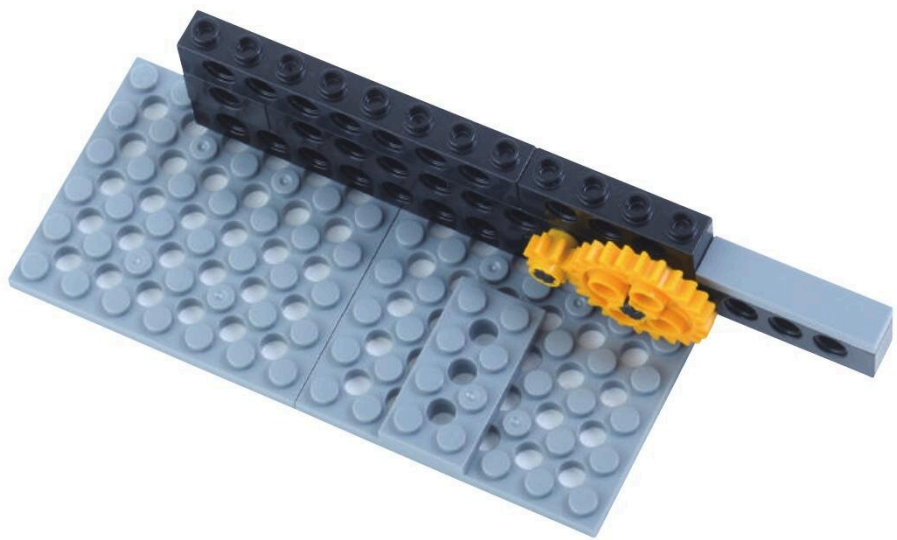
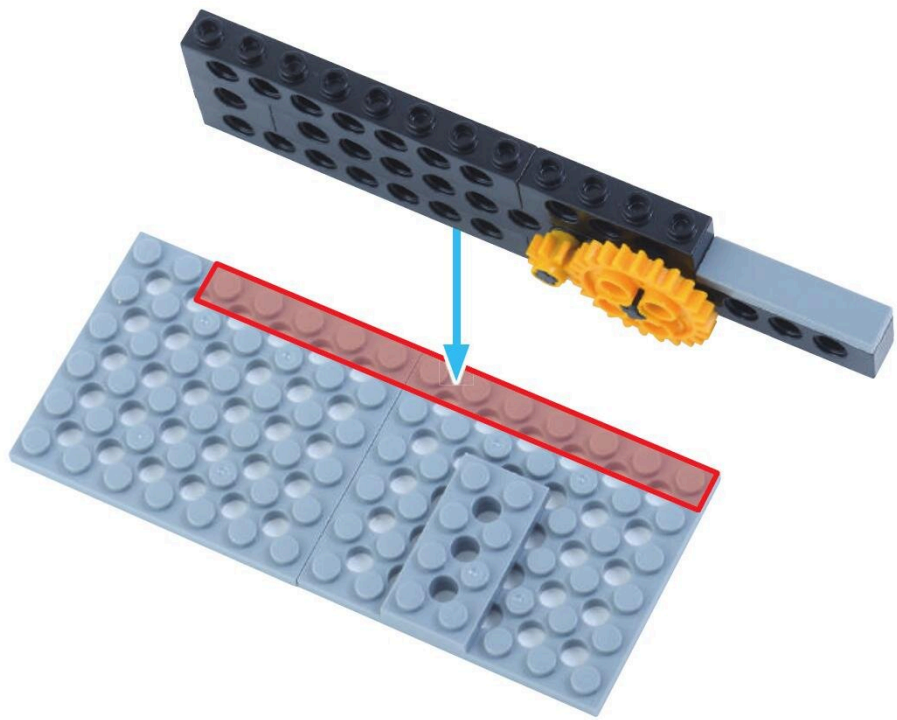

びいむよんほち  
ビーム4ポチ 6こ



びいむろくほち  
ビーム6ポチ 3こ

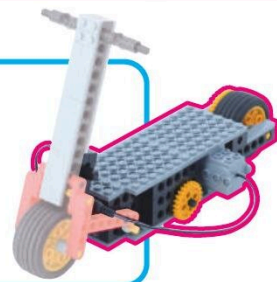

7

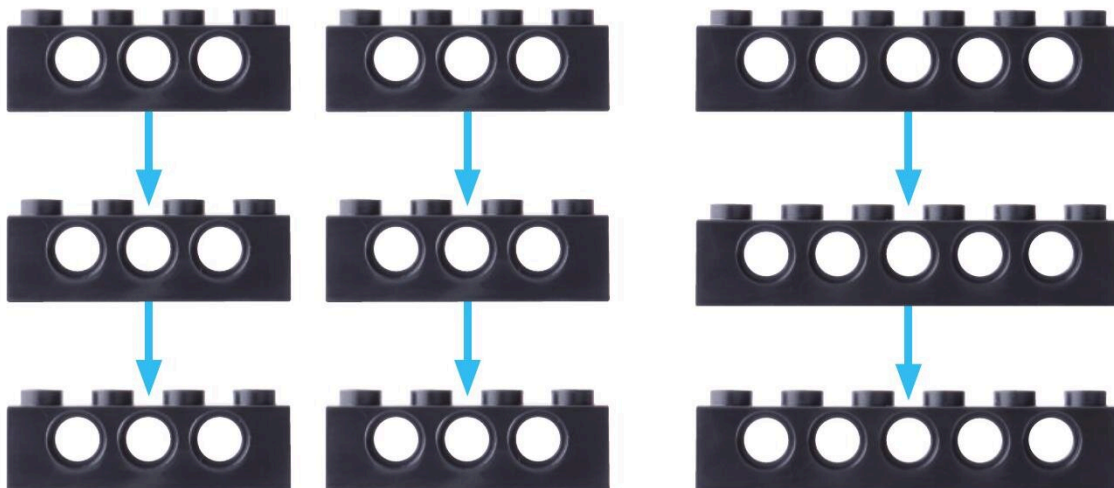



ふとぶれえとよんほち  
太プレート4ポチ 1こ

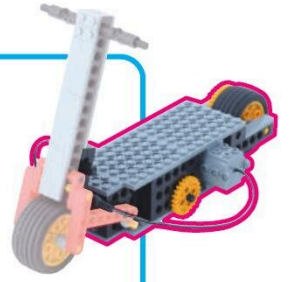

8

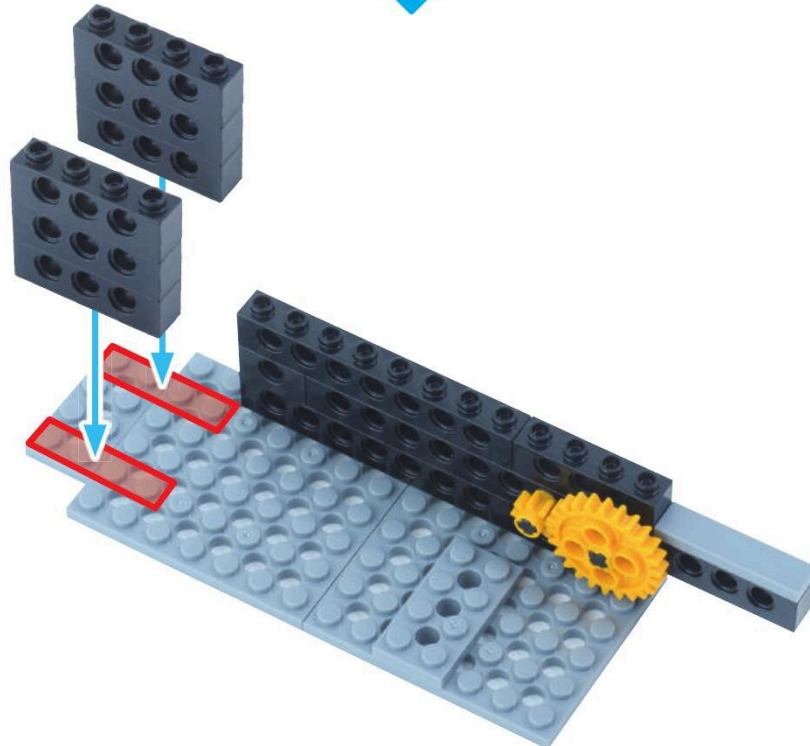
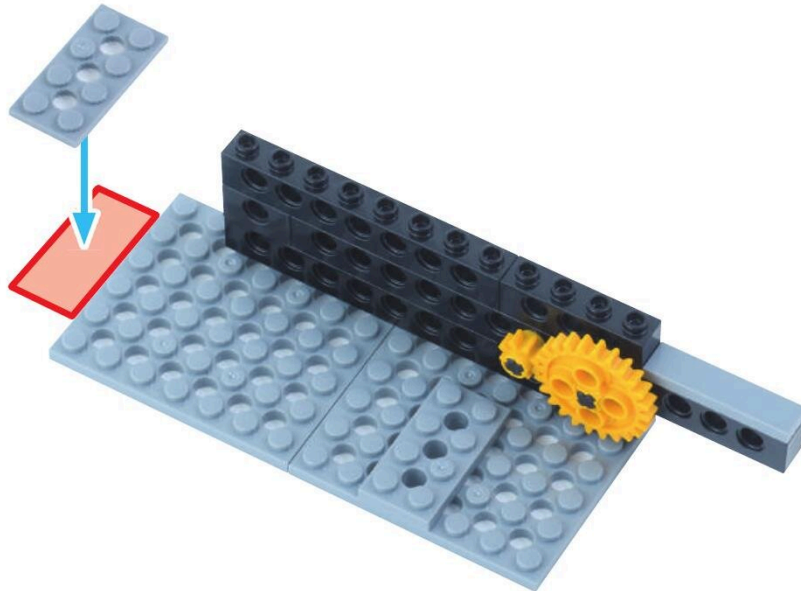

9

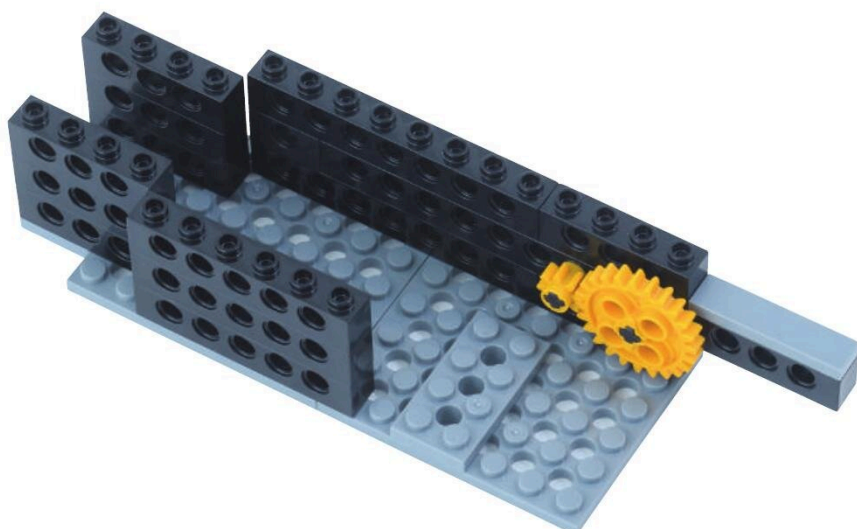
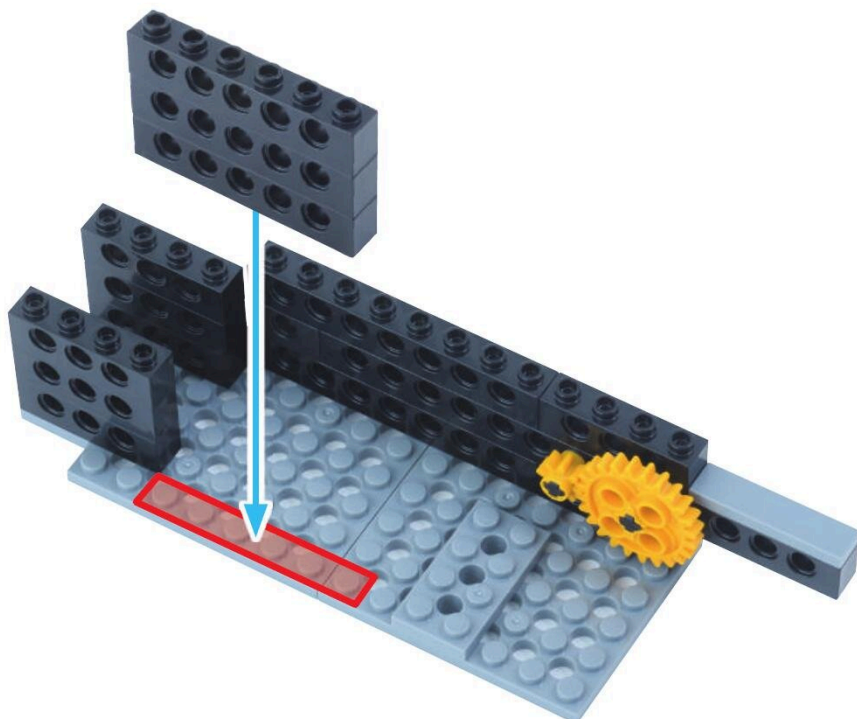

も お た あ せ っ と  
モーターセット



ふ と ぶ れ え と よん ほ ち  
太プレート 4 ポチ 1 こ

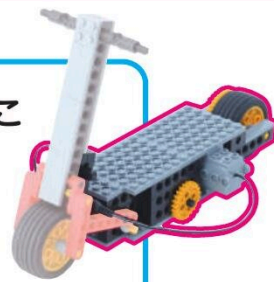

10

はずす

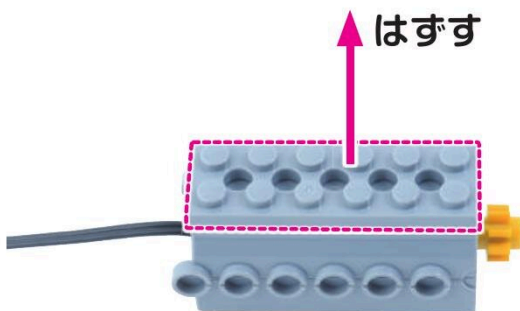

も お た あ せ っ と  
モーターセットから  
ふ と ぶ れ え と よん ほ ち  
太プレート 6 ポチを  
はずして  
ふ と ぶ れ え と よん ほ ち  
太プレート 4 ポチを  
つけるよ

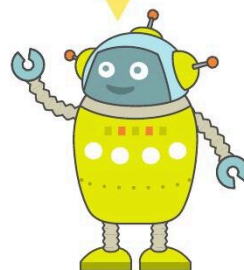

はずした <sup>ばあつ</sup> パーツは  
しまおう

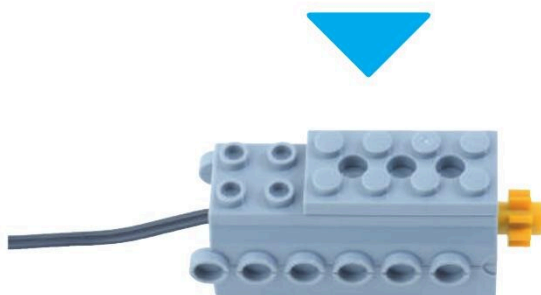
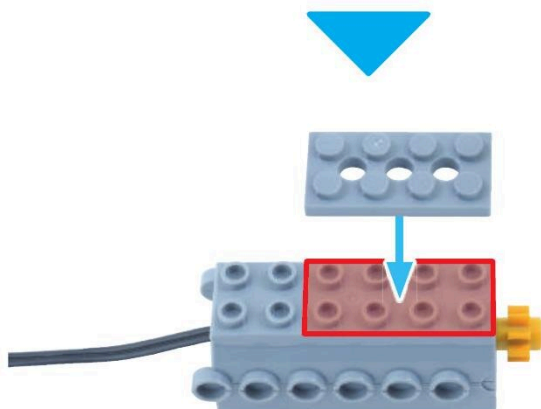



11

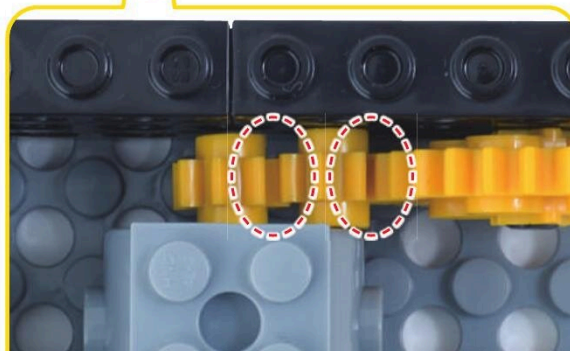
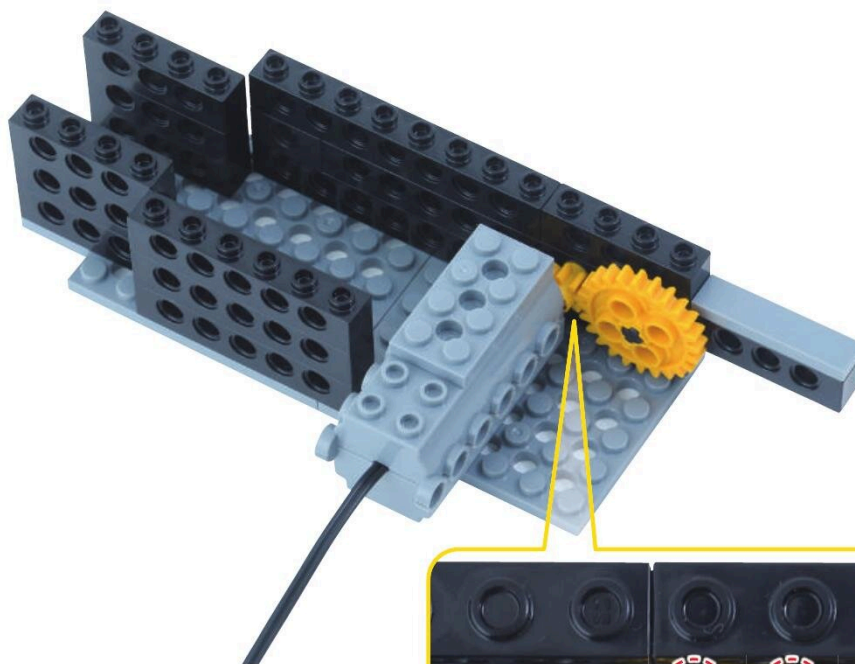
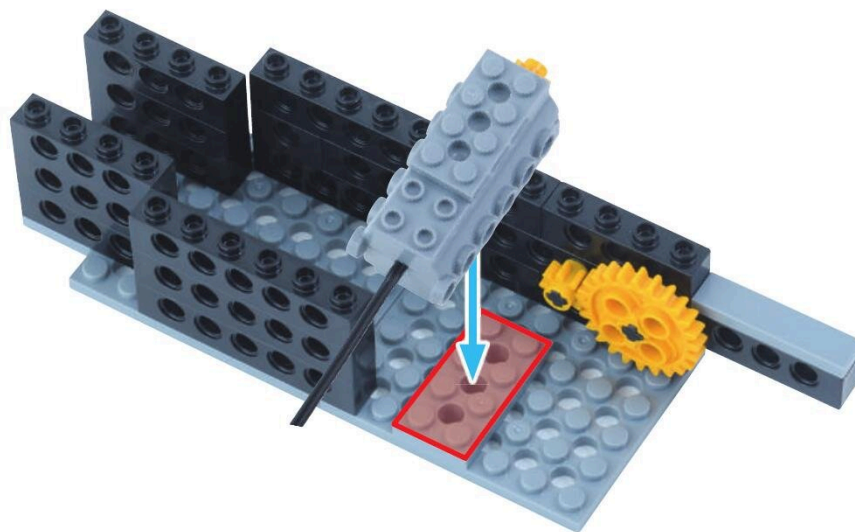

ギアが かみあっているか かくにん

ばってりいほっくす すらいどすいっち 1こ  
バッテリーボックス / スライドスイッチ 1こ

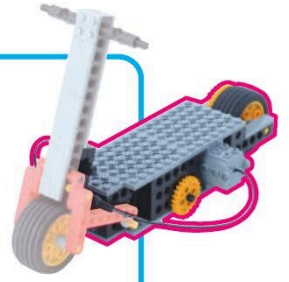

12

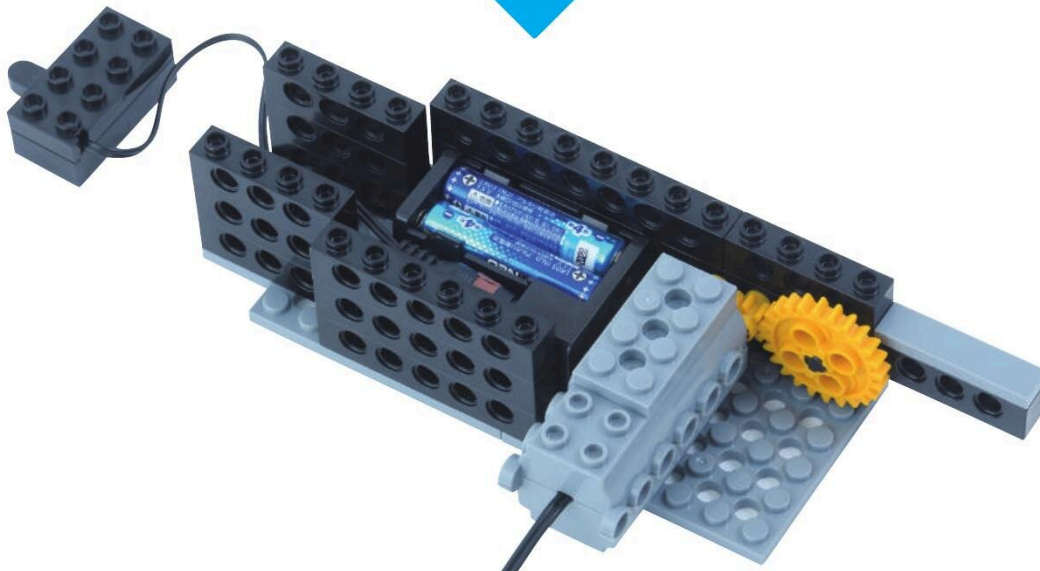
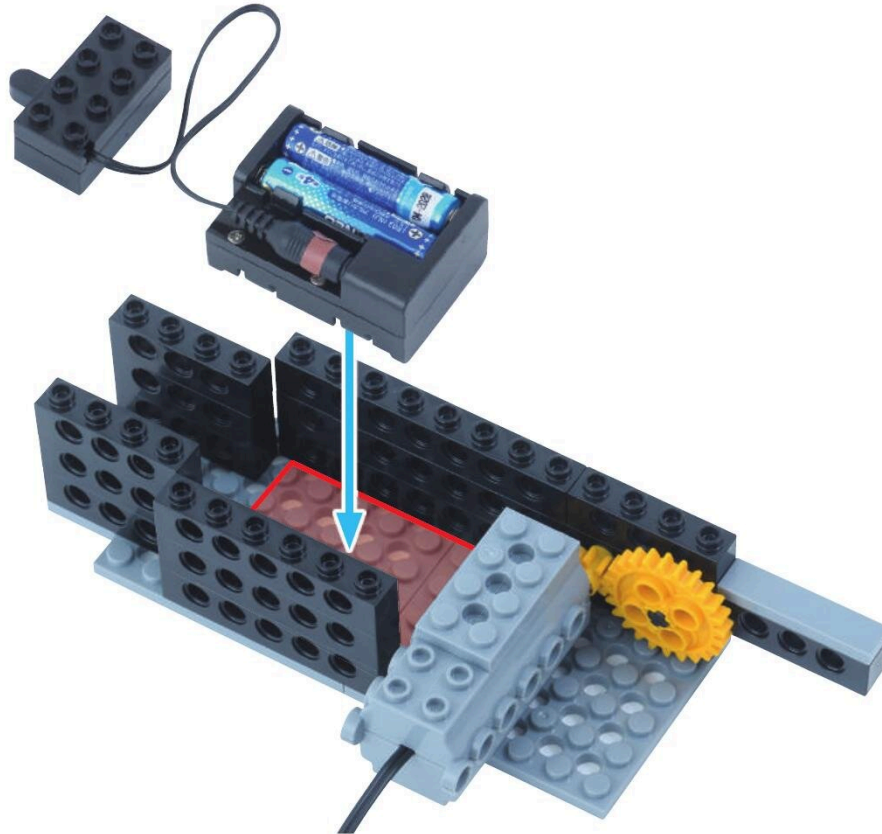

ふれえとる  
プレートL 1こ

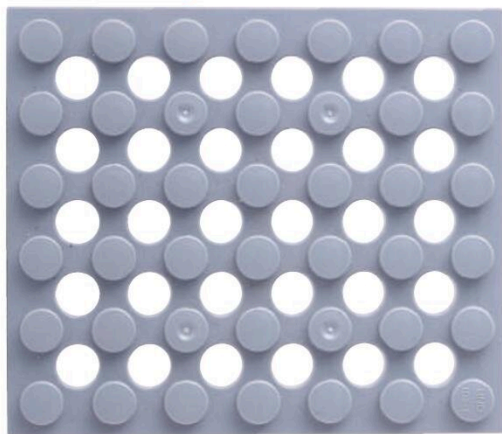

ふとふれえとぬほち  
太プレート4ポチ 1こ



13

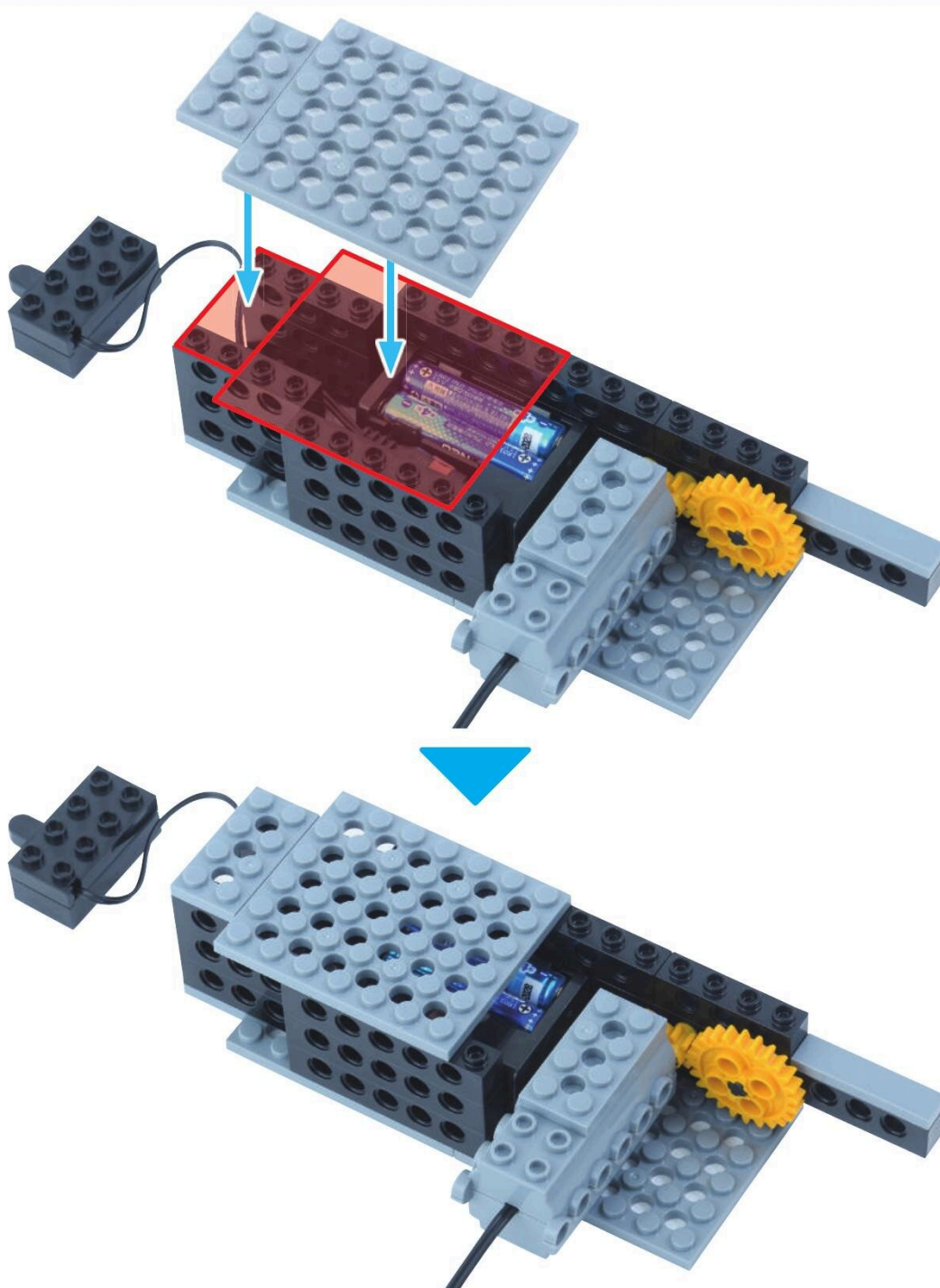





たいや<sup>える</sup>  
タイヤ 1こ

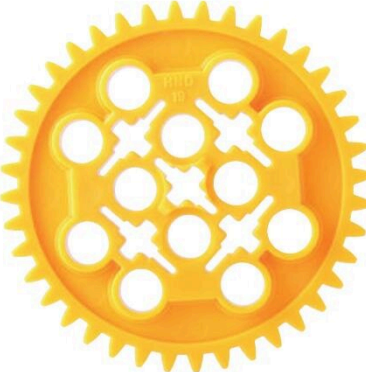

ぎあ<sup>える</sup>  
ギア 1こ





ぶっしゅ  
ブッシュ 1こ







しゃふと<sup>ろく</sup>ぼち  
シャフト 6ポチ 1こ



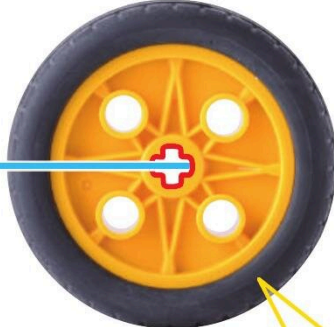
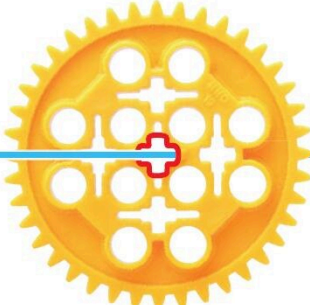

ながさに  
ちゅうい

14









たいや  
タイヤの むきに ちゅうい  
へこんでいるほうが うら

びいむろくほち  
ビーム6ポチ 1こ



たいる  
タイル 1こ



しゃふとびいむにほち  
シャフトビーム2ポチ 2こ

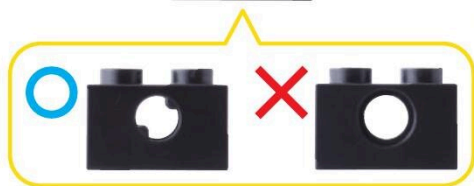

15

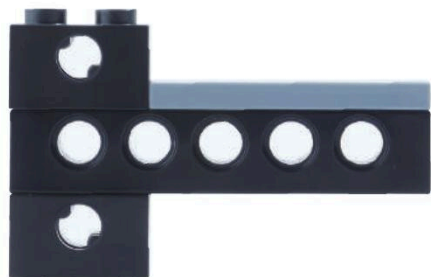
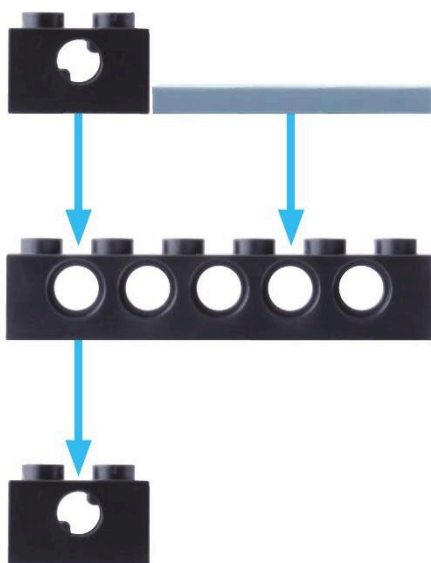

16

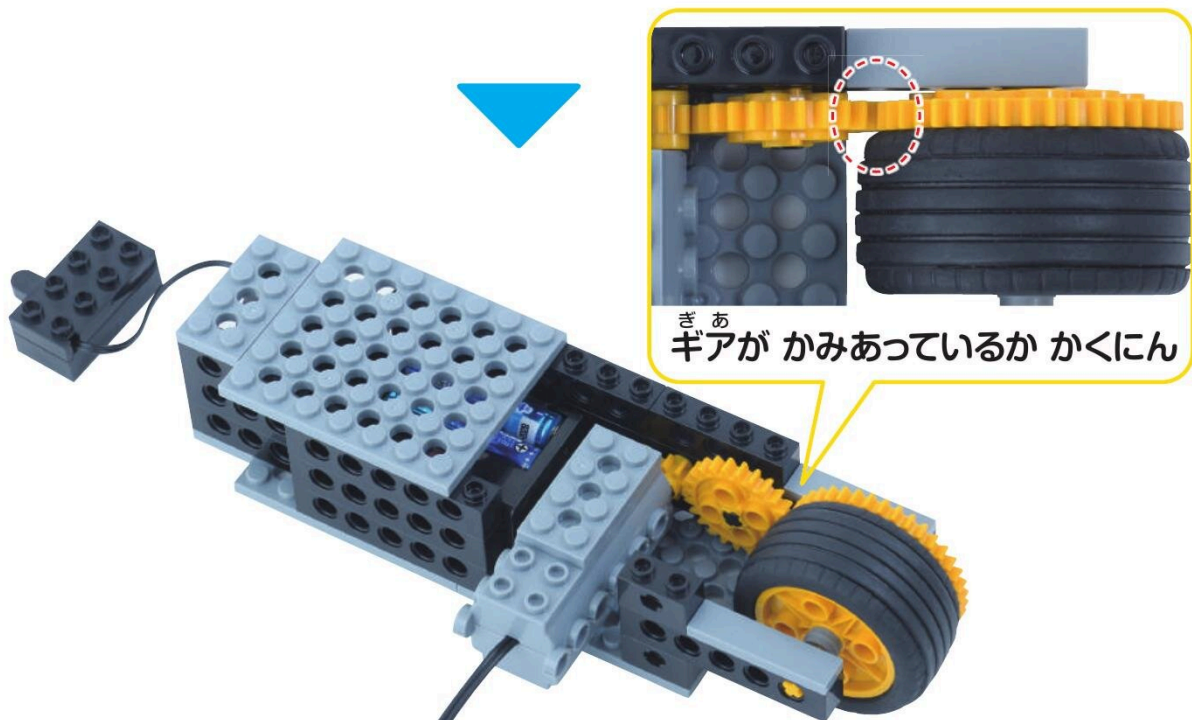
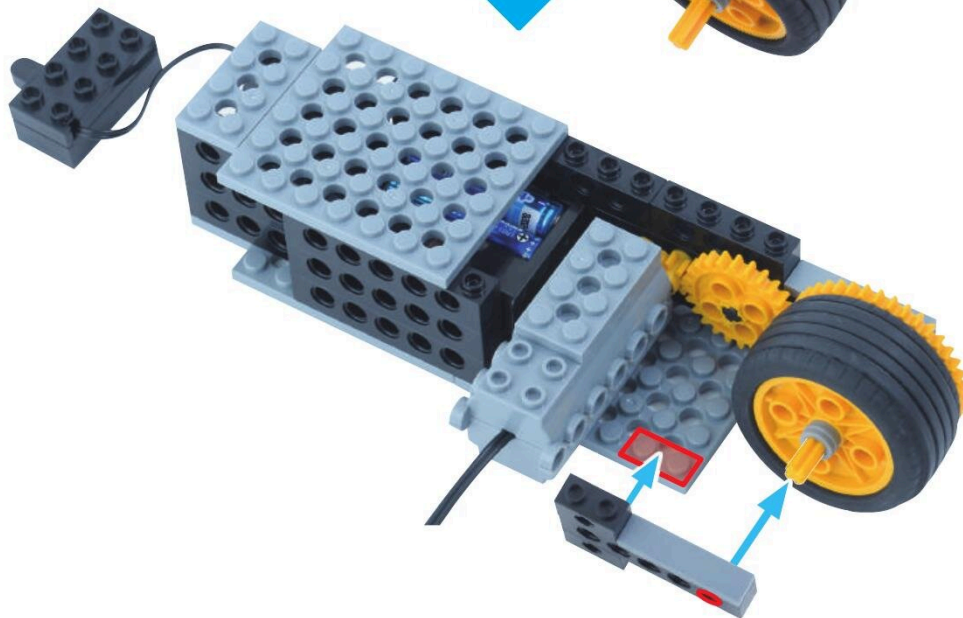
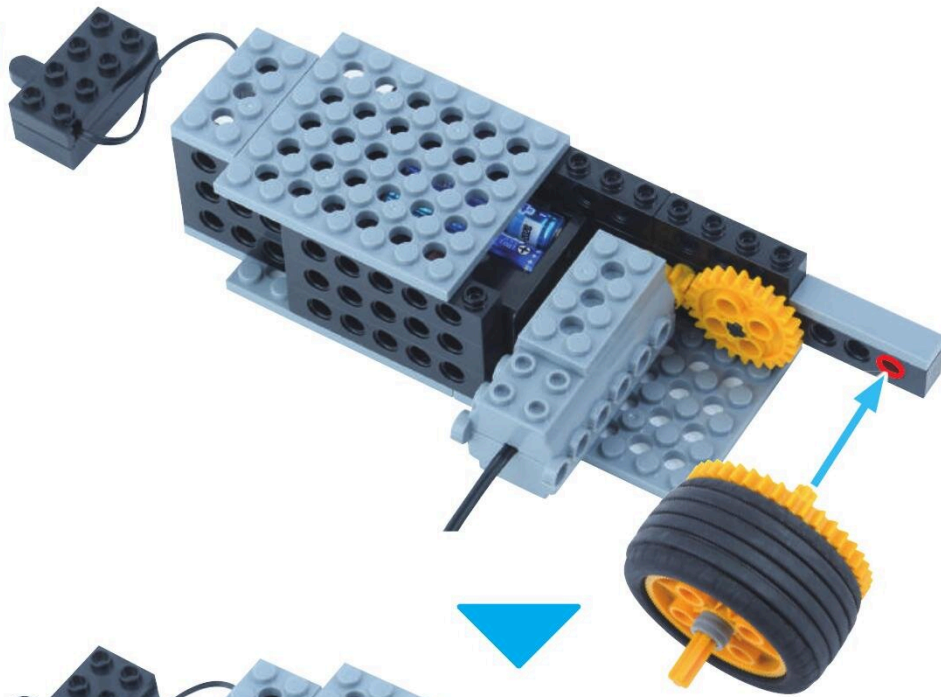



ふれえとる  
プレートL 1こ

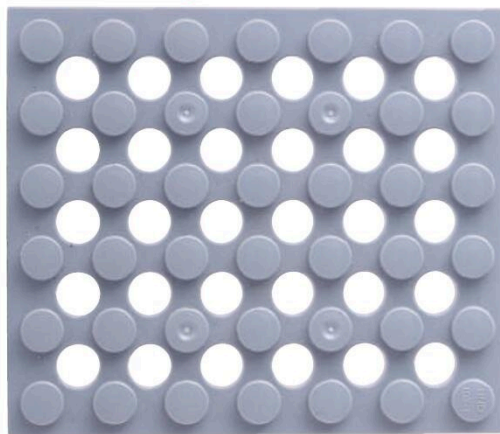

17

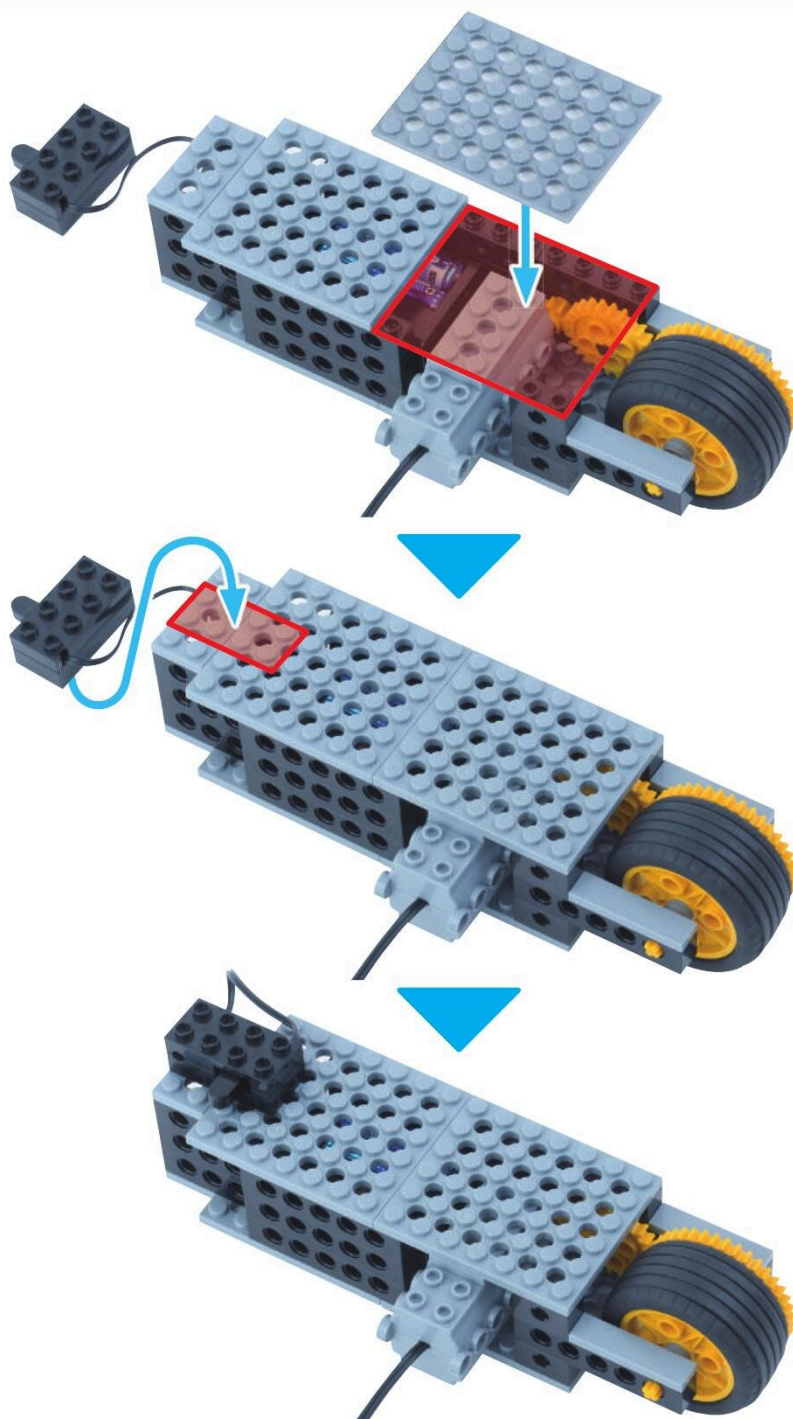

ぎあえむ  
ギア M うす 2 こ

しゃふとへぐ  
シャフトペグ 2 こ

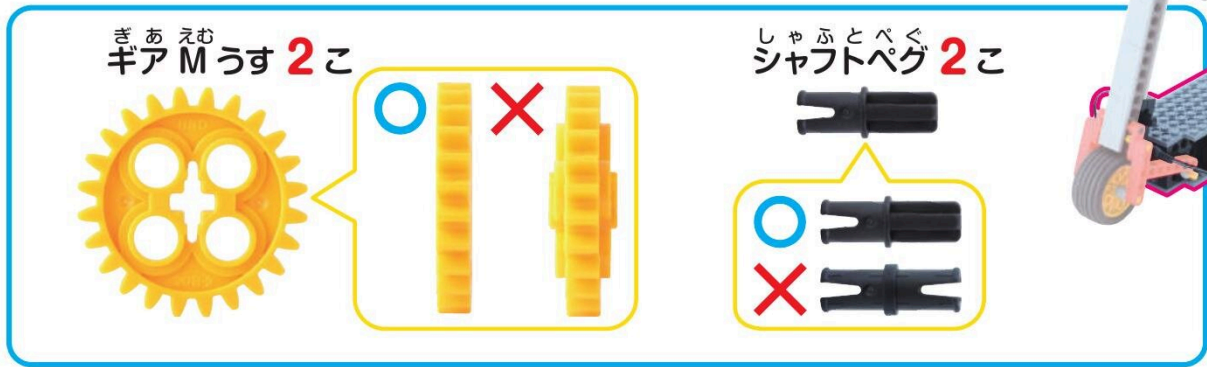

18

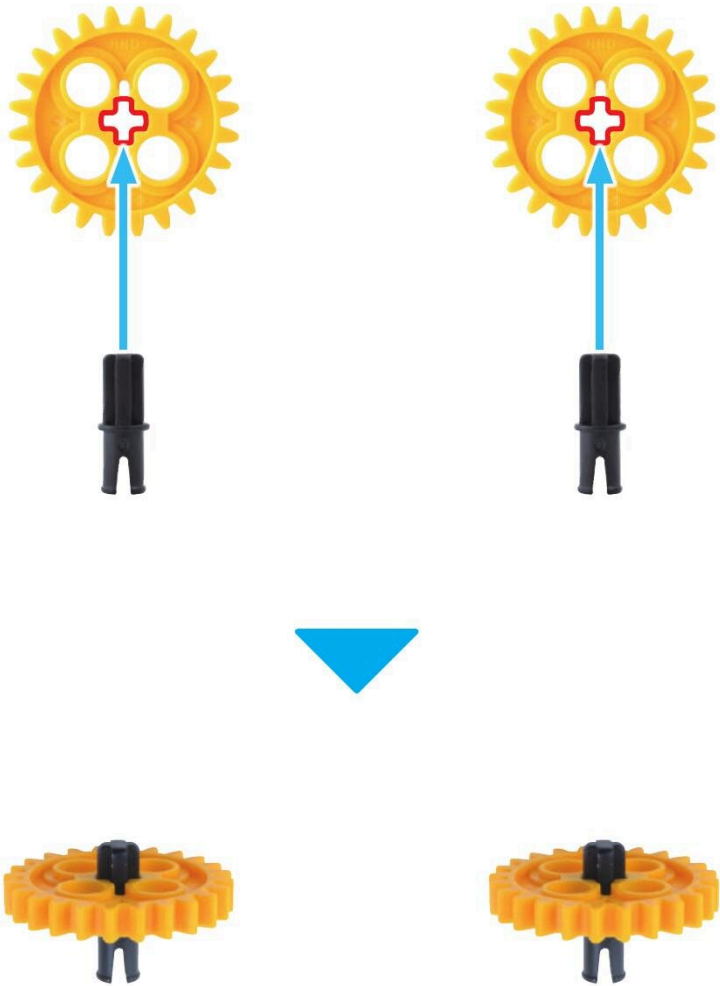

19





20

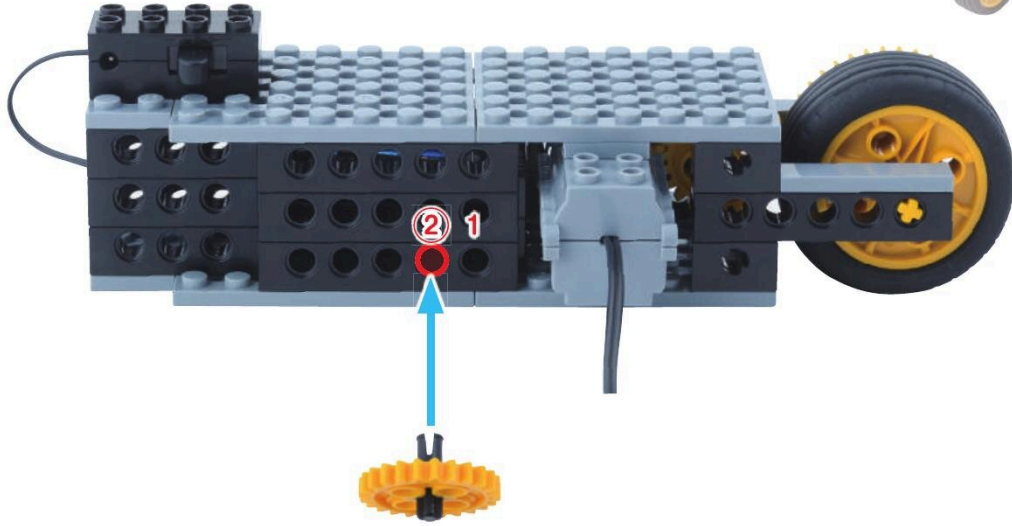

ほおど  
ボードが  
かんせい!

やったね!

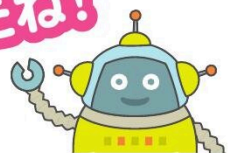

ろぼっと  
ロボットを うごかそう

めやす 5 ぶん

こおど  
コードをつなごう

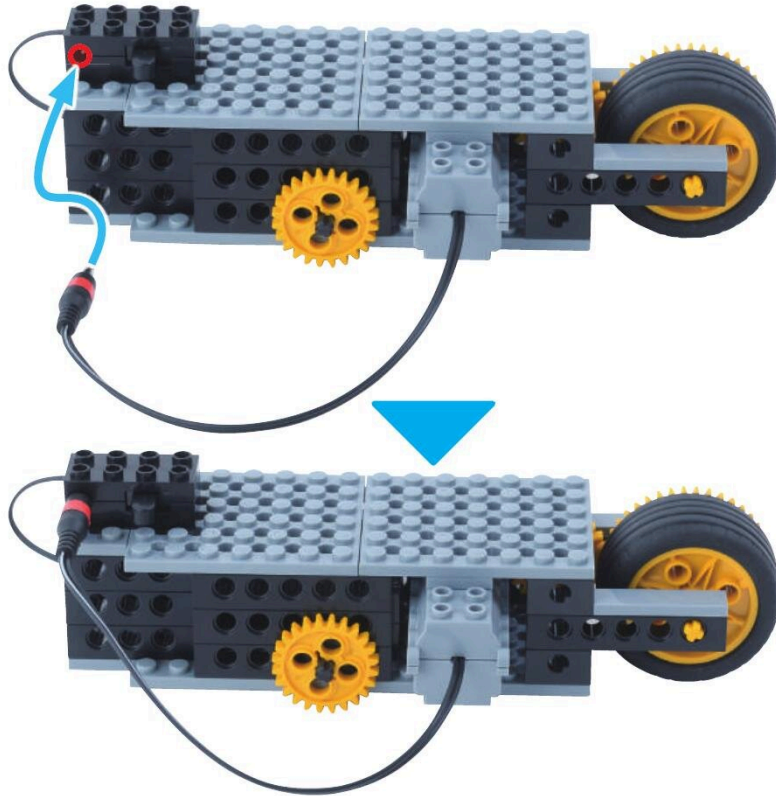

すいっち  
スイッチを 入れて うごかそう

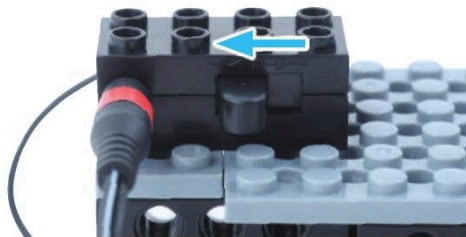

ろぼっと  
ロボットは  
まえに  
すすんだかな？

あとで  
はずしておこう

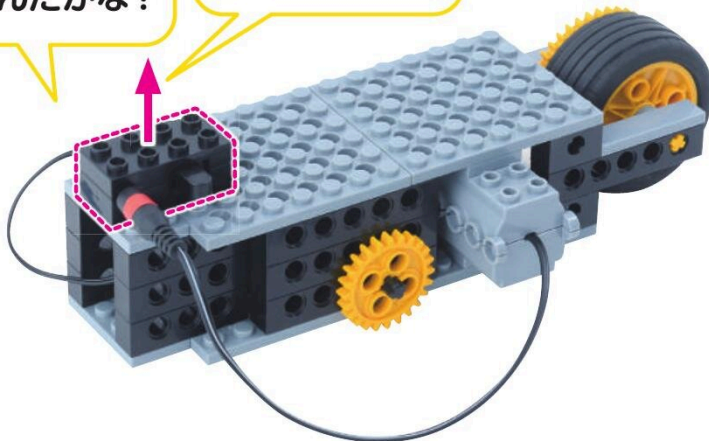

うごかしたら  
すいっち  
スイッチを もどして  
こおど  
コードを めいておこう。



すいっち  
スイッチを ぼおど  
ボードから  
はずしておこう。



2

は ん ど る  
ハンドル

めやす 10 ぶん

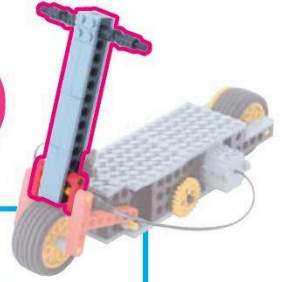

びいむじゅうん ぼち  
ビーム 14 ポチ 2 こ



ふとぶれえとろく ぼち  
太プレート 6 ポチ 1 こ



ふとぶれえとよん ぼち  
太プレート 4 ポチ 1 こ



1

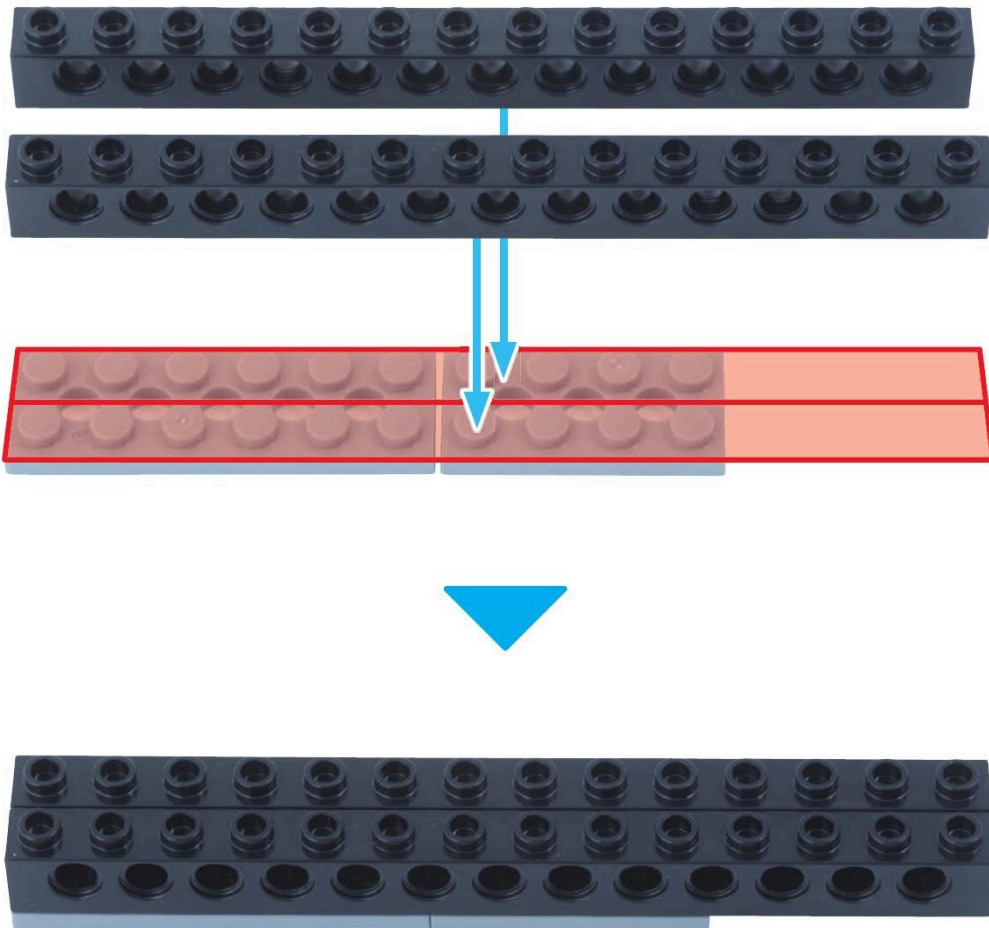



ほそぶれえとにほち  
細プレート2ポチ **2**こ



たいる  
タイル **6**こ

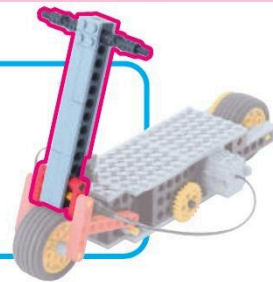

2

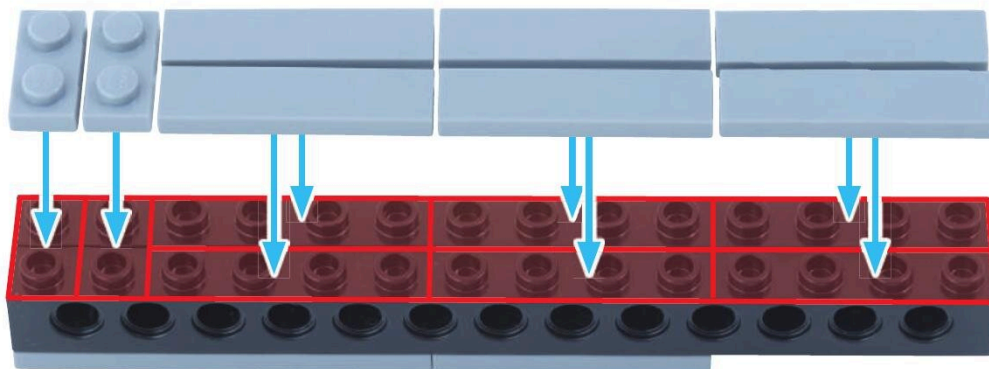

あなしゃふとじょいんと  
アナシャフトジョイント 2こ



くろしゃふとにほち  
黒シャフト2ポチ 2こ



ながい



みじかい

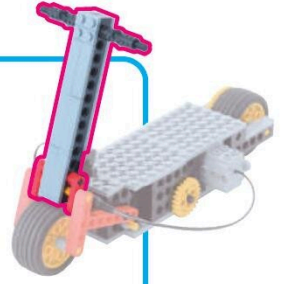

3



しゃふとよんほち  
シャフト 4 ポチ 1こ

ながさに  
ちゅうい

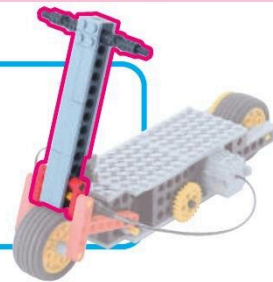

4

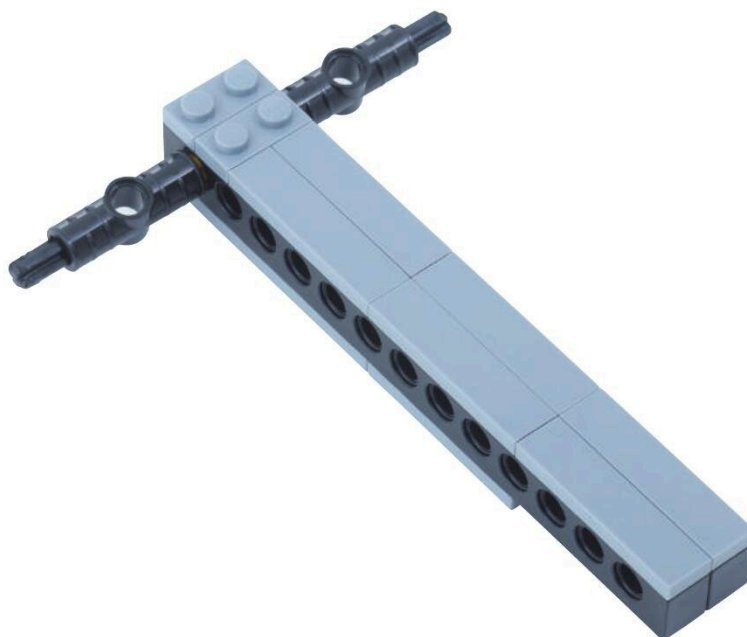
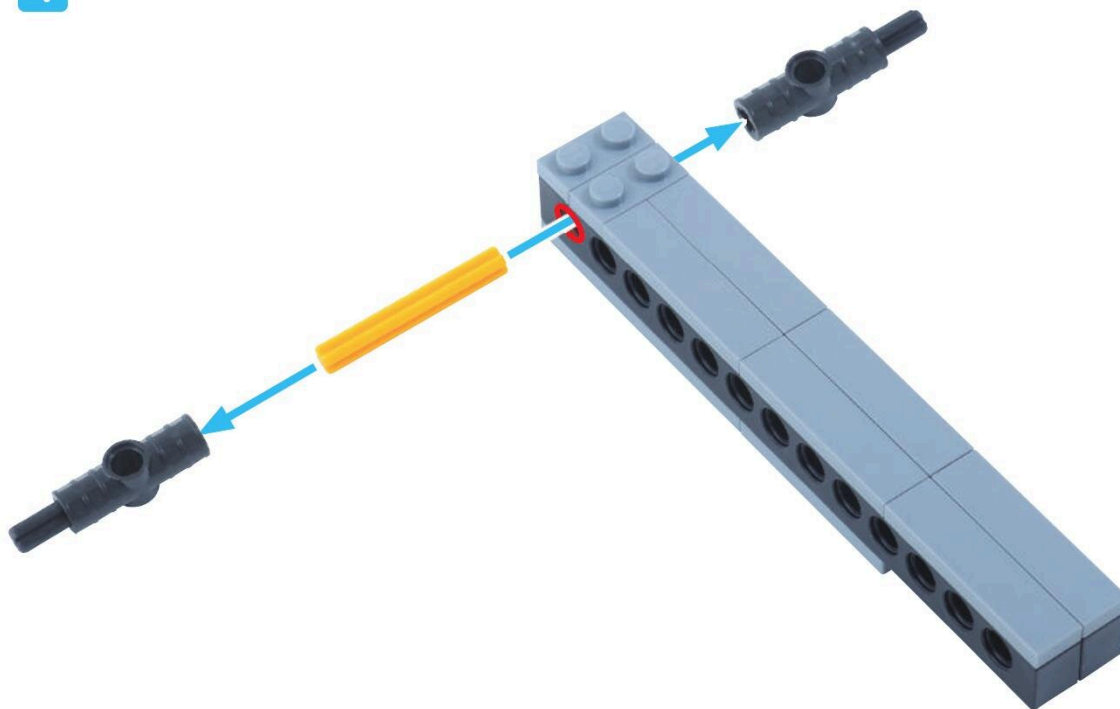



くらんく 2こ  
クランク 2こ

しゃふとペグ 2こ  
シャフトペグ 2こ

しゃふと 3く ぼち  
シャフト 6 ポチ 1こ

ながさに  
ちゅうい

5

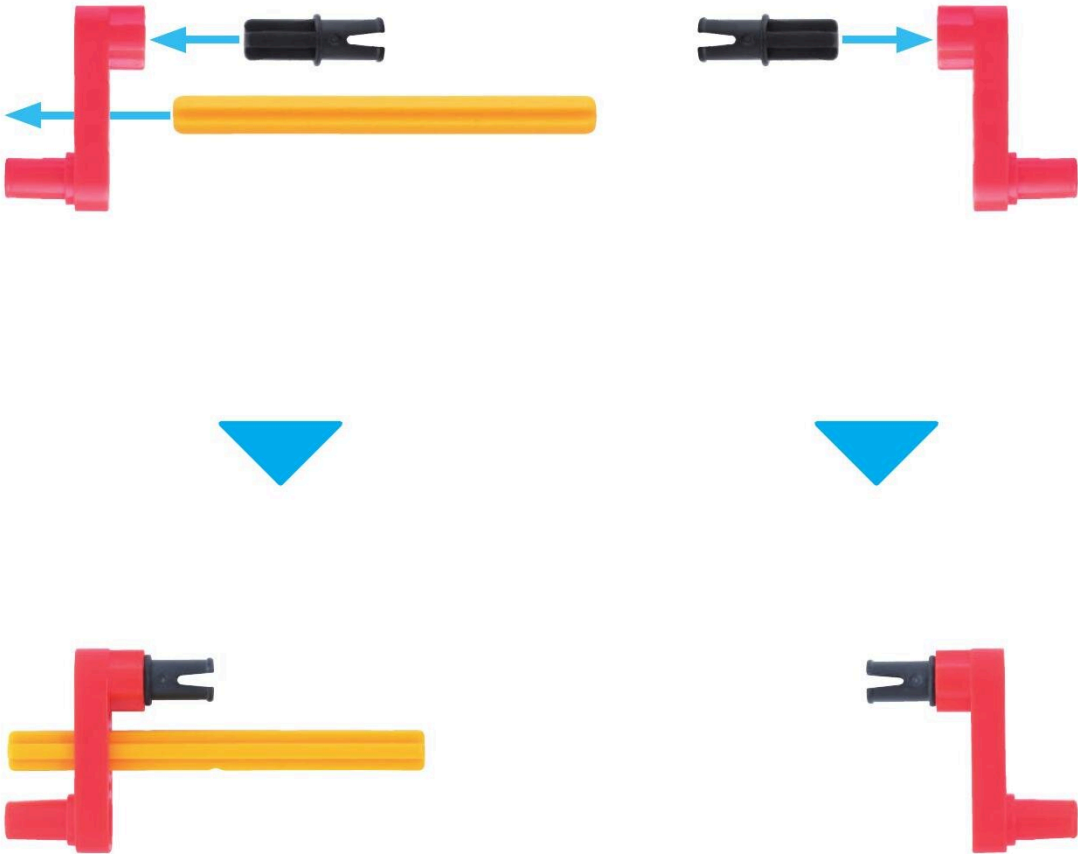

6

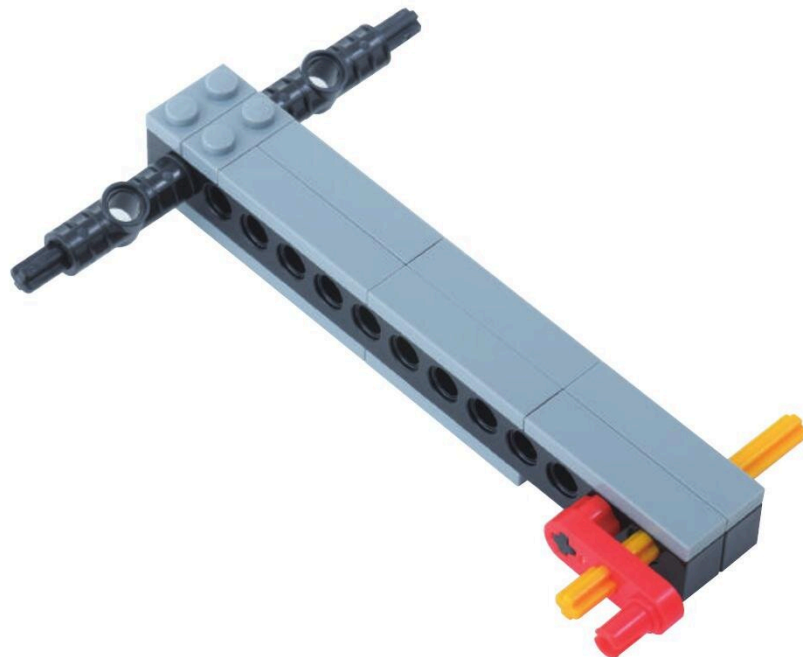
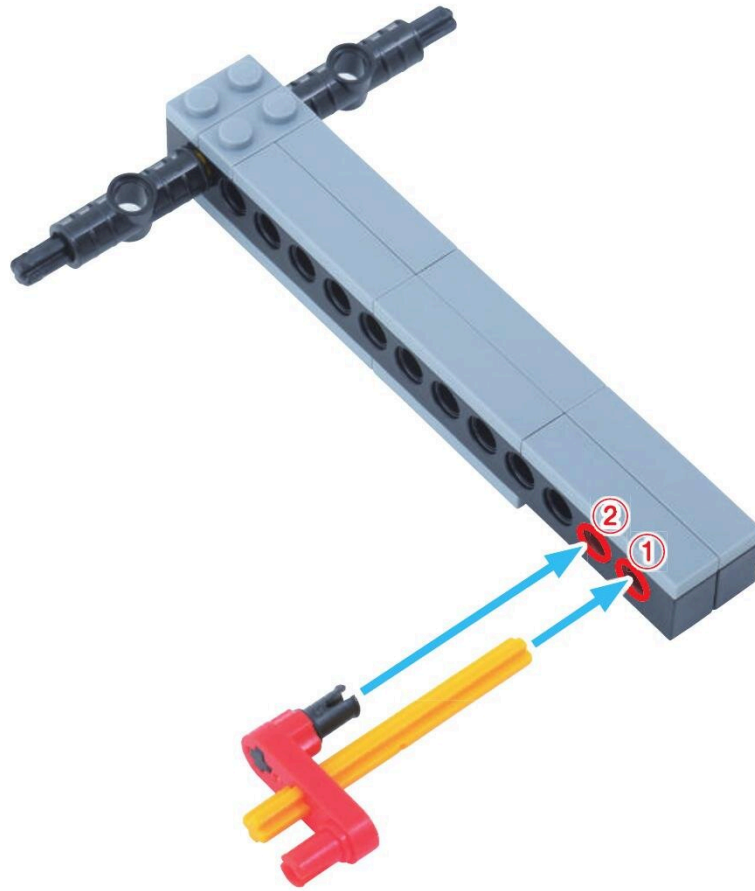

7

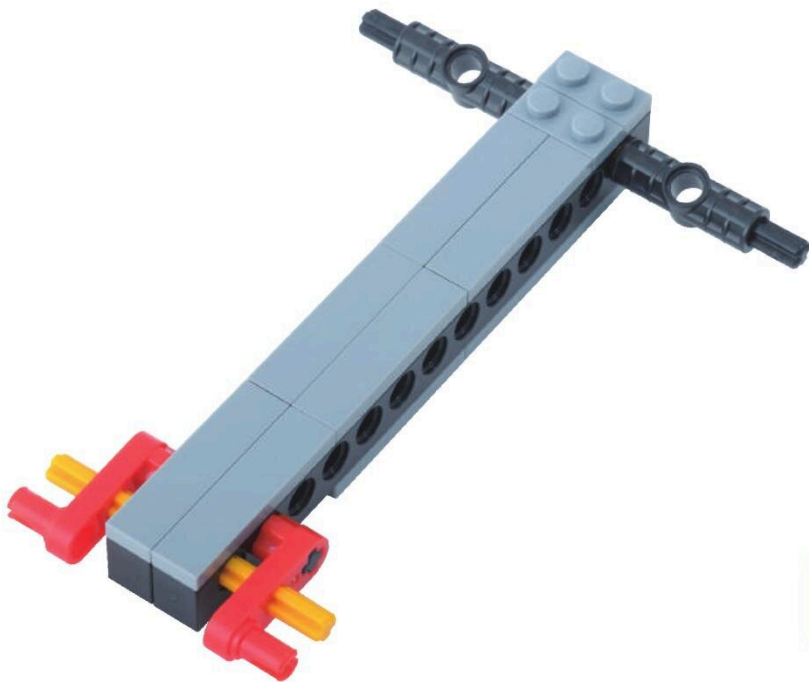
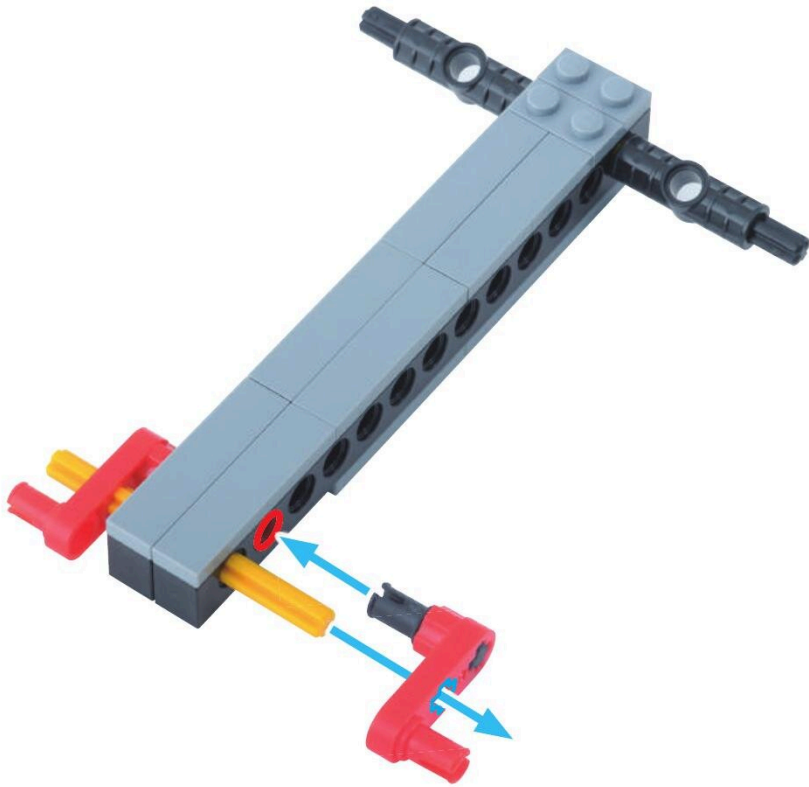
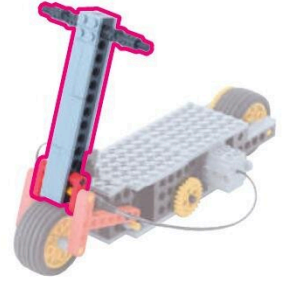

はんどる  
ハンドルが  
かんせい!

やったね!





3

す と つ ば あ  
ストッパー

めやす 5 ぶん

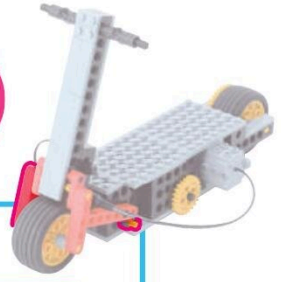

ていじょいんと  
Tジョイント 1こ



ぶっしゅ  
ブッシュ 1こ



しゃふとぶち  
シャフト 6ポチ 1こ



pegu  
ペグ S 1こ



ながさに  
ちゅうい

1

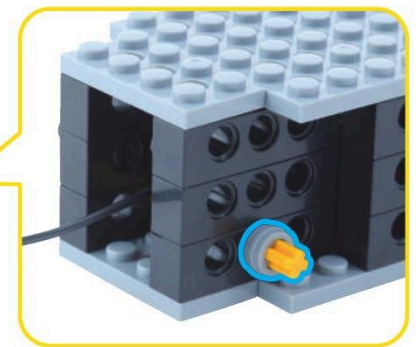
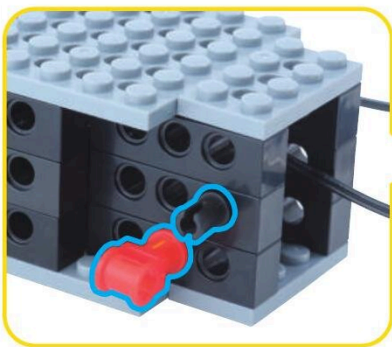
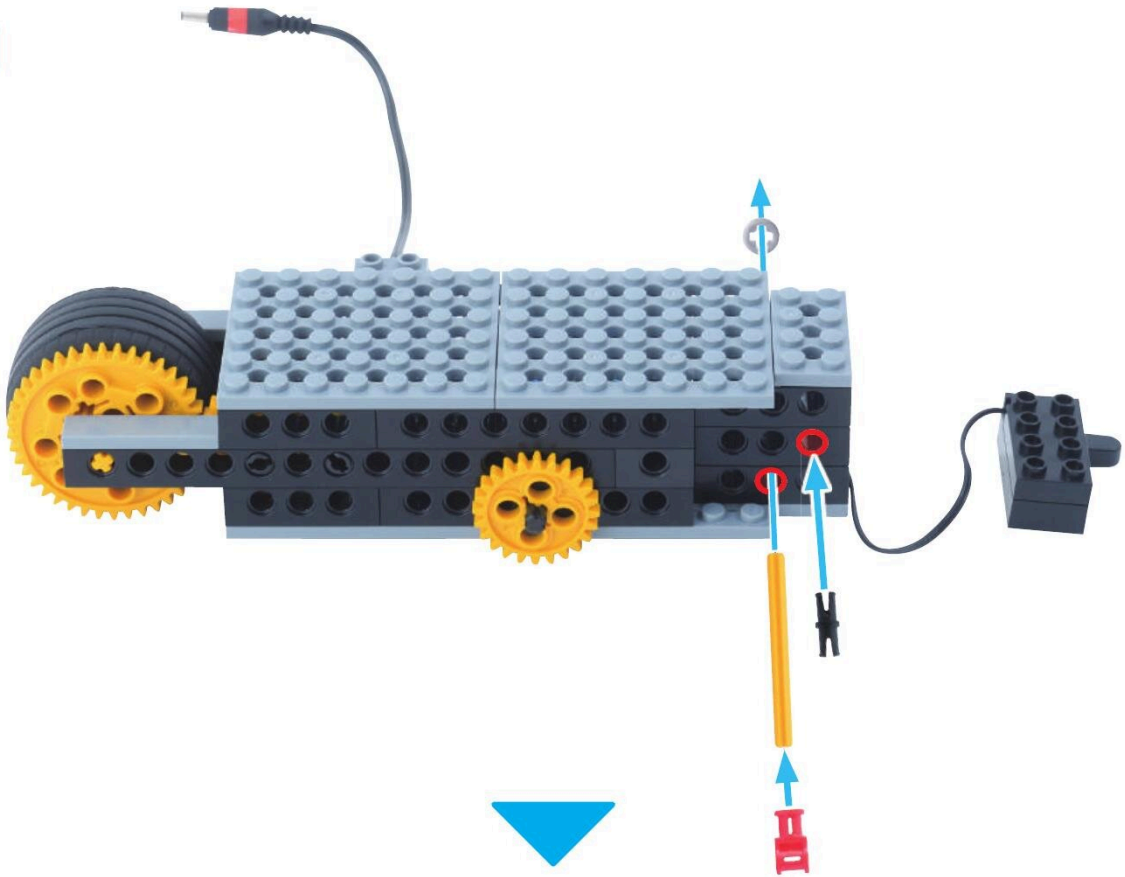

てい るっど  
T ロッド 1こ

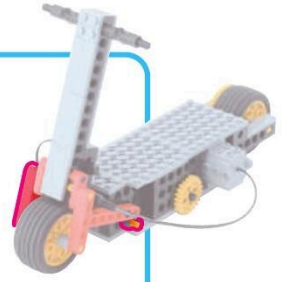
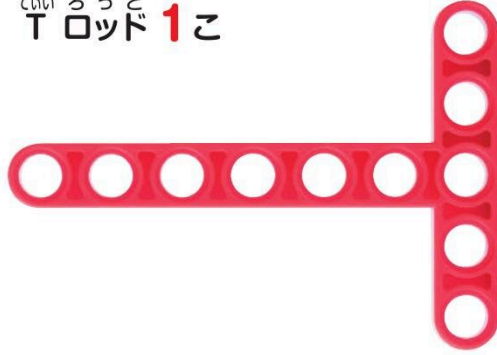

2

は んどる  
ハンドルの  
むきに  
ちゅうい

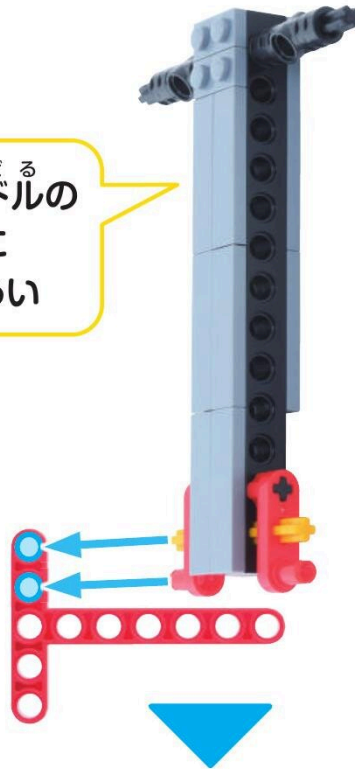

3

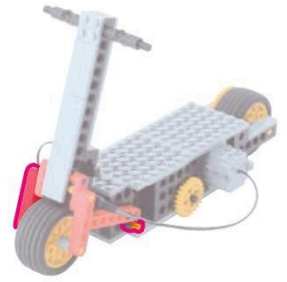
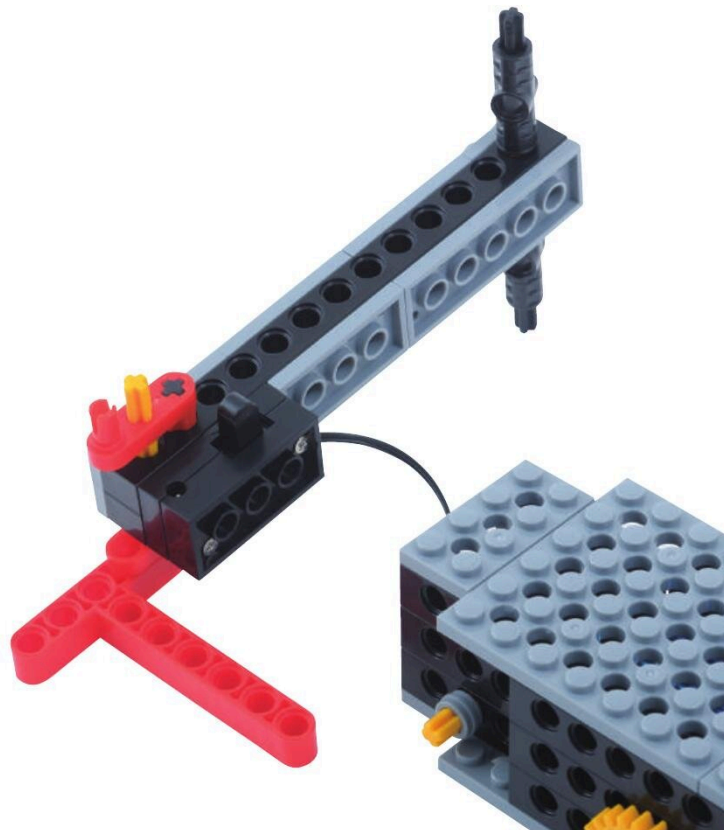
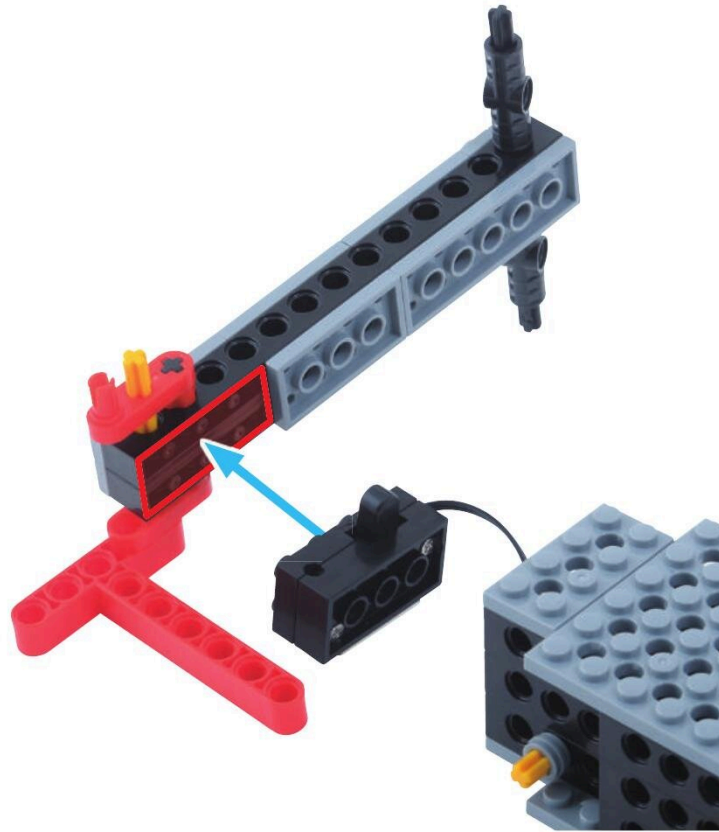



4

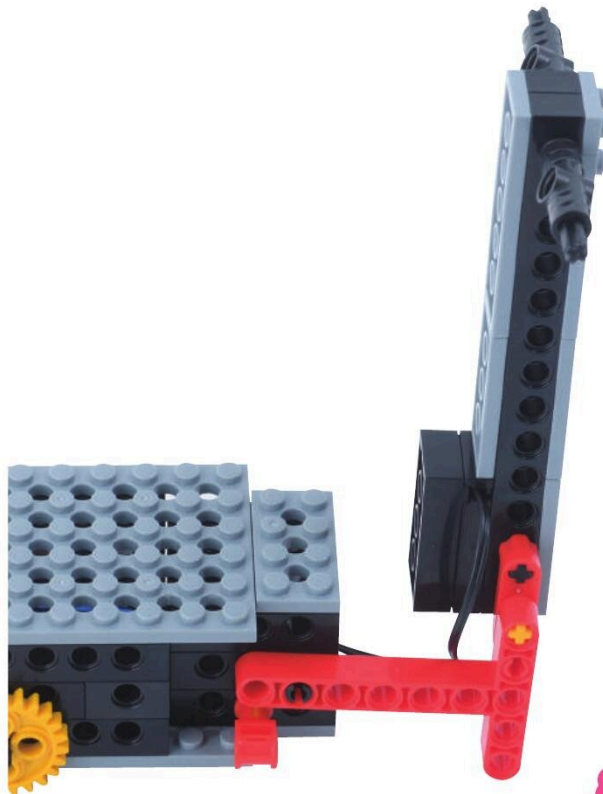
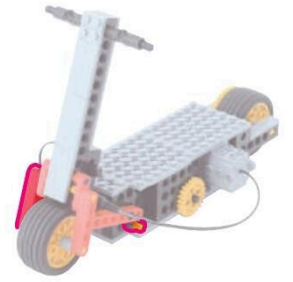
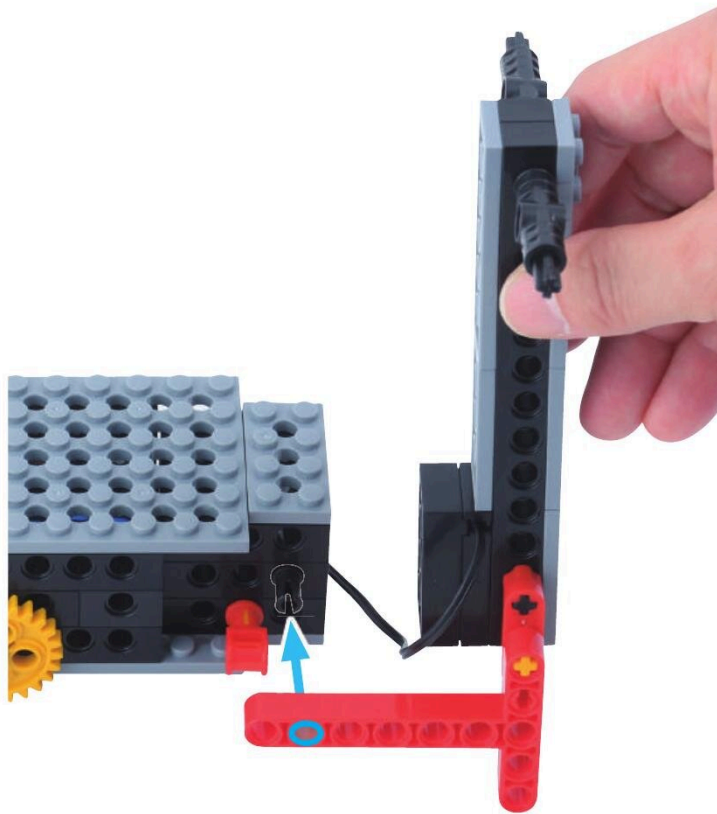

す と っ ぽ あ  
ス ト ッ パ ー が  
か ん せ い !

や っ た ね !



4

ぜんりん

めやす 5 ふん

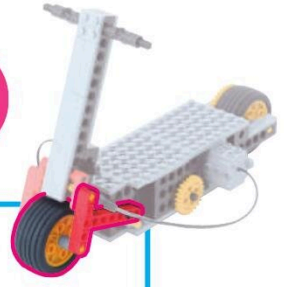

たいやえる  
タイヤ 1こ



ぶっしゅ  
ブッシュ 6こ



しゃふとぶくほち  
シャフト 6ポチ 1こ



ながさに  
ちゅうい

1

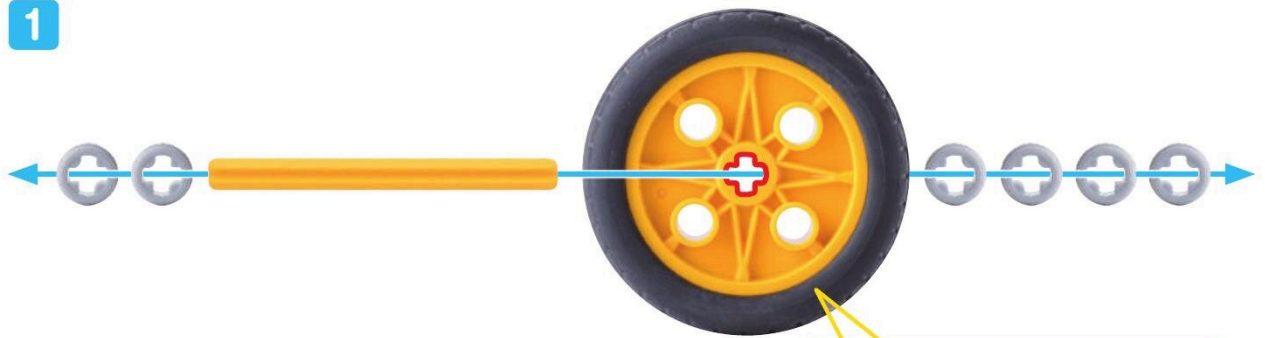

たいや  
タイヤの むきに ちゅうい  
へこんでいるほうが うら



2

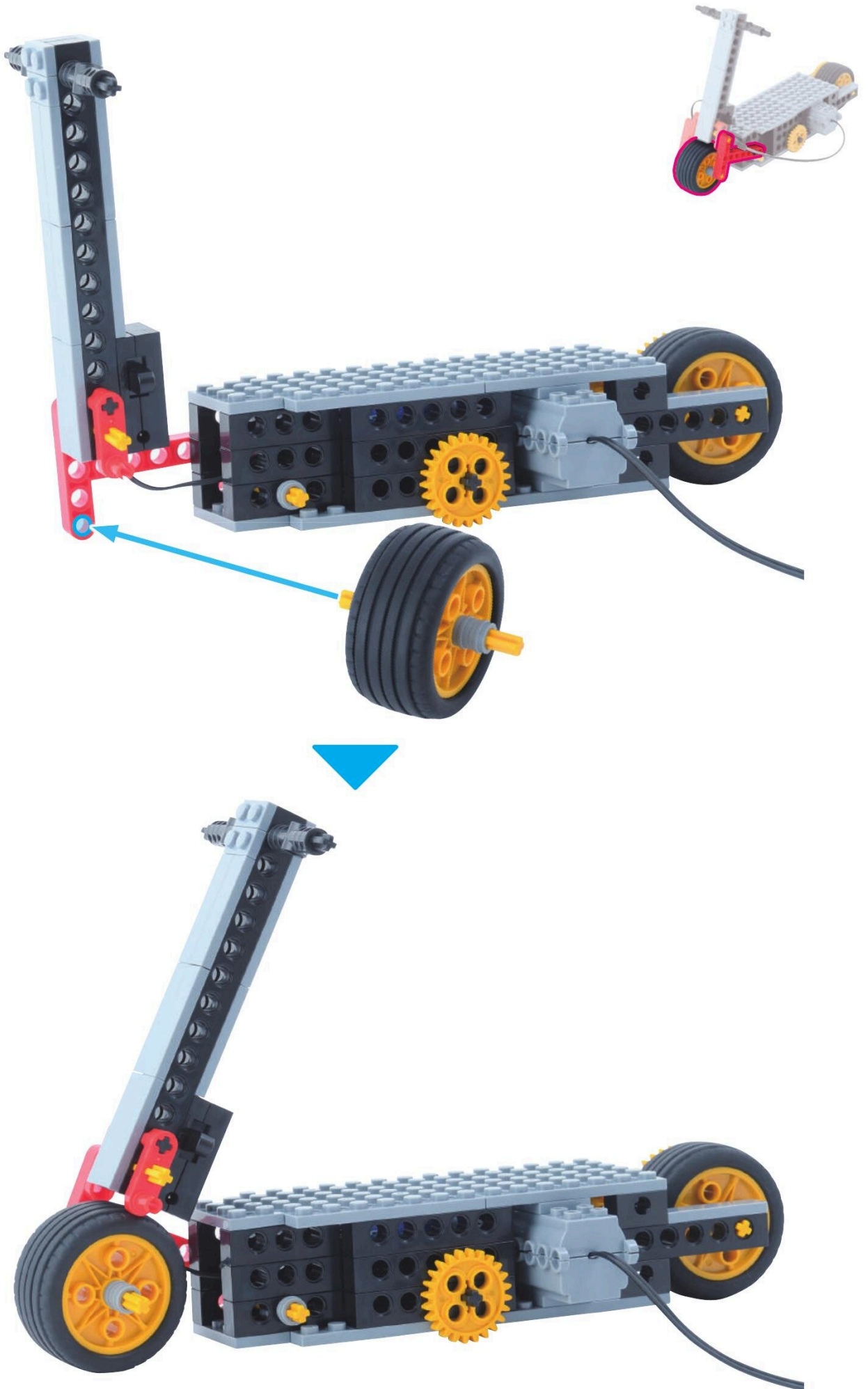



peg 1 pc



rod 1 pc

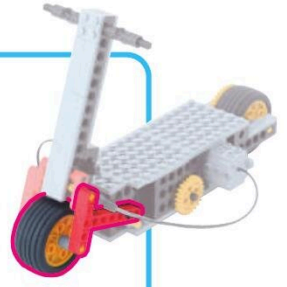
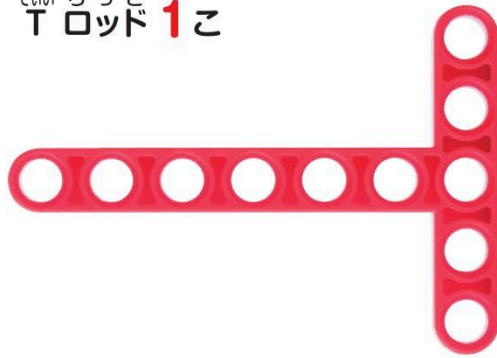

3

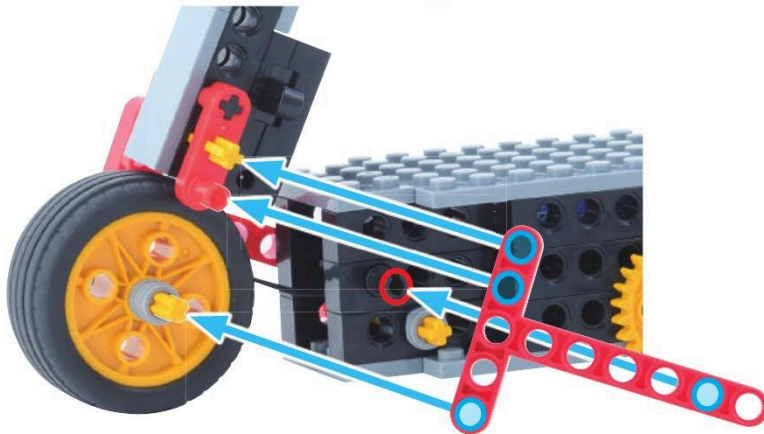
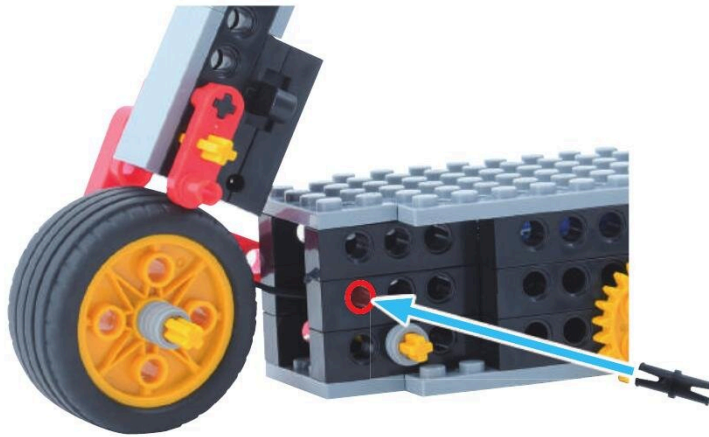

これで  
かんせい!

よくできました!



ろぼっと  
ロボットを うごかそう

めやす 5 ぶん

こおど  
コードをつなごう

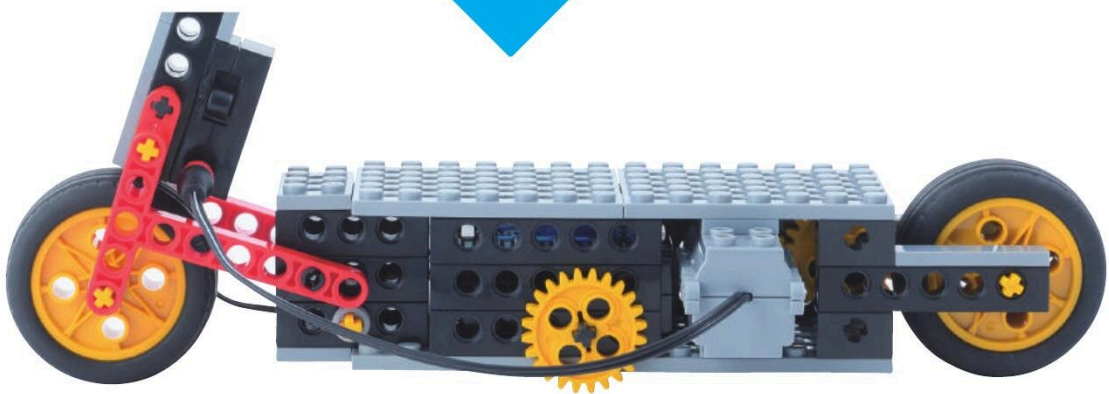
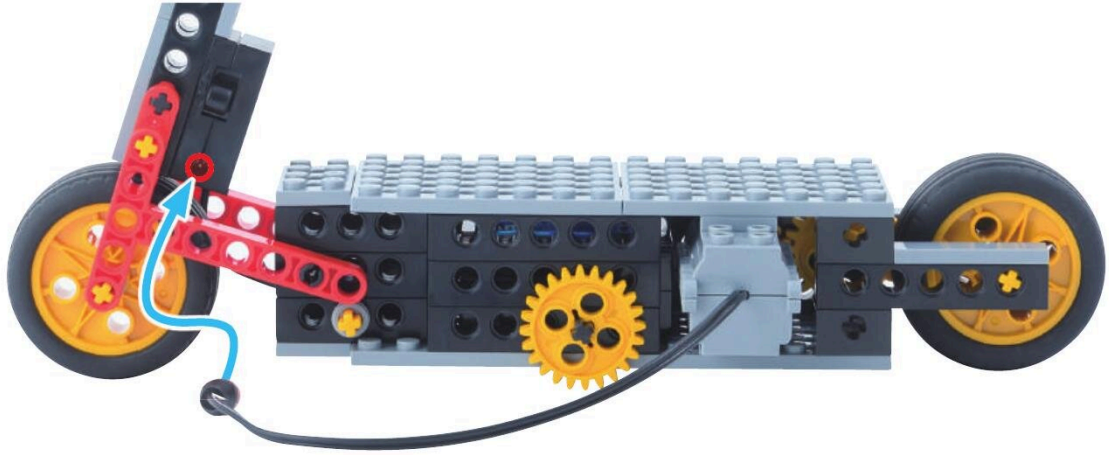

すいっち  
スイッチをいれて うごかそう

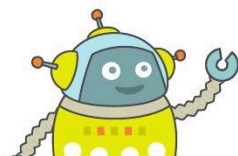

ろぼっと  
ロボットは  
まえにすすんだかな？

はんだる  
ハンドルの おりたたみかた

すどっばあ  
ストッパーを  
はずして  
おりたたもう

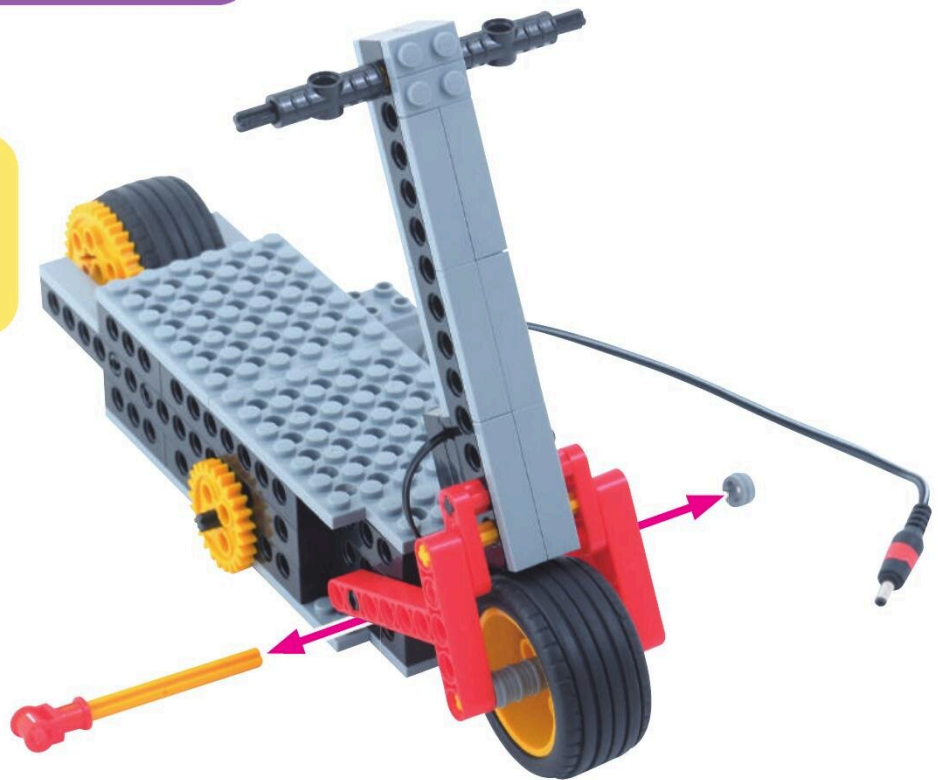
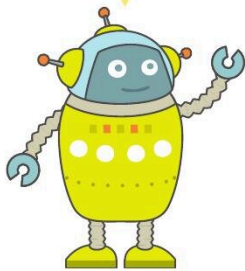

すどっばあ  
はずしたストッパーは  
はんだる  
ハンドルにつけておこう

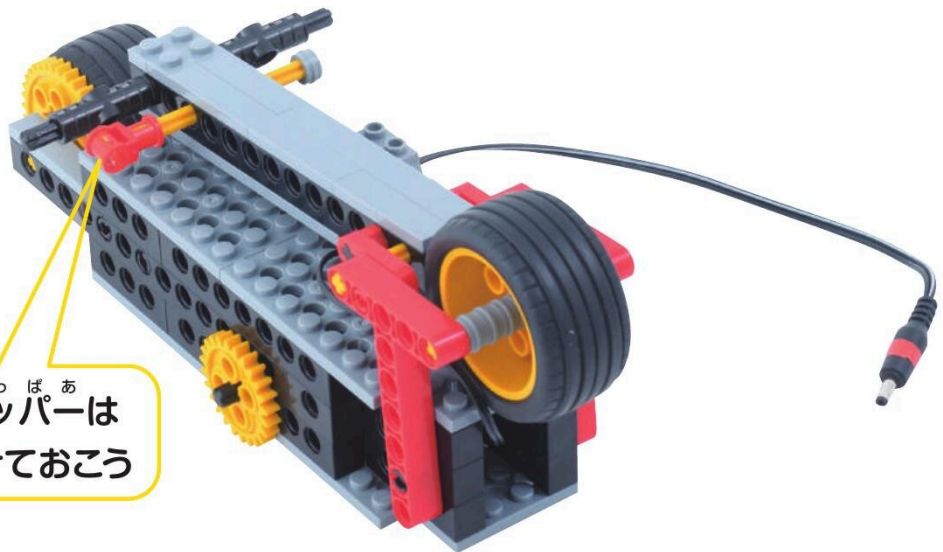



Q1 <sup>ぎあ</sup> <sup>え</sup> **ギア** <sup>え</sup> **L** を さがそう! どれかな? どれかに○

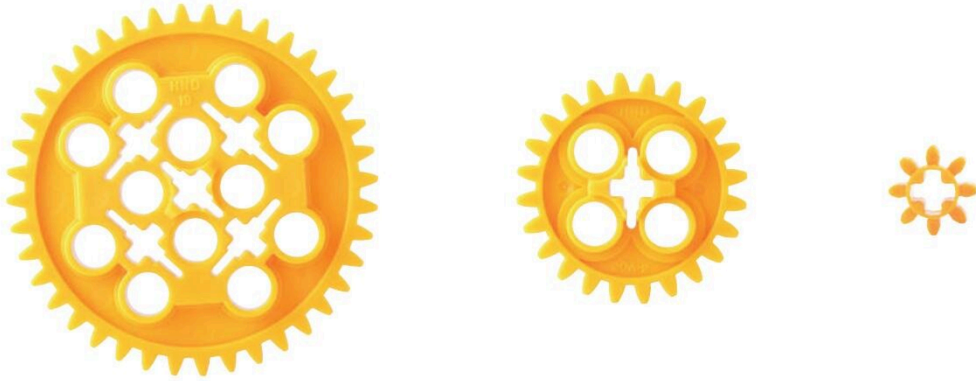

Q2 この<sup>ぎあ</sup> **ギア**には <sup>へぐ</sup> <sup>え</sup> **ペグ** **S** を なんこ とりつけられるかな?



( 1 こ ・ 4 こ ・ 5 こ ) どれかに○

Q3 この<sup>ぎあ</sup> **ギア**には <sup>しゃふと</sup> **シャフト** を なんぼん とりつけられるかな?

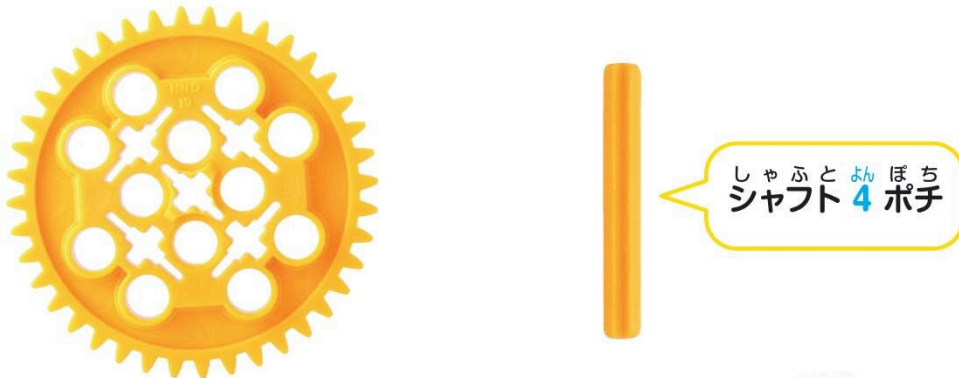

( 1 ぽん ・ 5 ほん ・ 12 ほん ) どれかに○





Human

ヒューマンアカデミー ジュニア



ロボット教室

# ロボットのきょうかしよ

プレプライマリーコースⅡ

2

のって はして 「キック<sup>き</sup>ボー<sup>く</sup>ダー<sup>ぼ</sup>」<sup>お だ あ</sup>



★だい2かい

2025 ねん

4 がつ

にち

なまえ

もくじ

だい 2 かい

きょうの よてい	47	2ぶん
くみたて		80ぶん
1. あたま	48~51	
2. ひだりあし	52~57	
3. みぎあし	58~64	
4. みぎうで	65~67	
5. ひだりうで	68~73	
ろぼっと ロボットを うごかさう	74	
こおる ゴールをつくってはしらせよう	75	
じゆうに かいぞう してみよう	76	
まちがい さがし	77	3ぶん
かたづけ		5ぶん

はんとる  
ハンドルを たてて  
すとっばあ  
ストッパーをもどしておこう

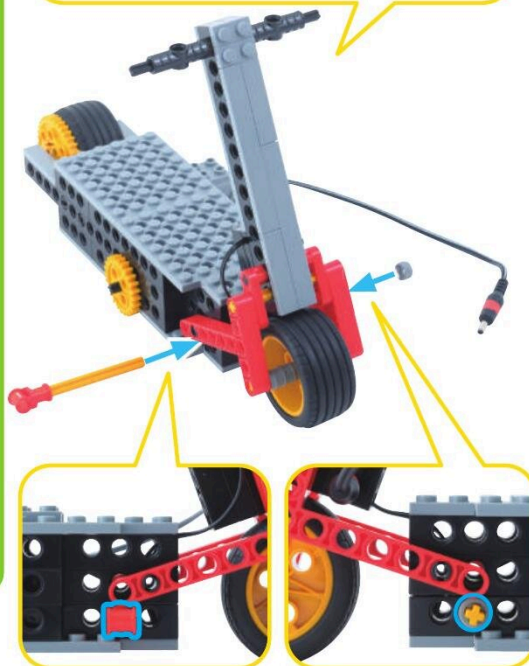

こんかいは ひとを  
つくって のせるよ

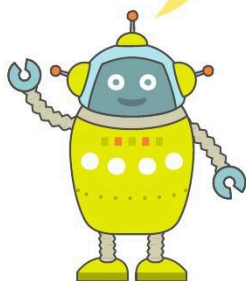

きょうの よてい

めやす 2 ぶん

このじゅんばんでつくるよ!



①あたま



②ひだりあし



③みぎあし

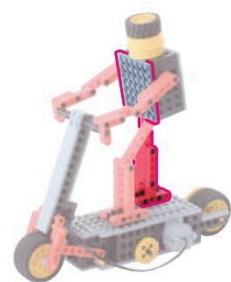

④みぎうで

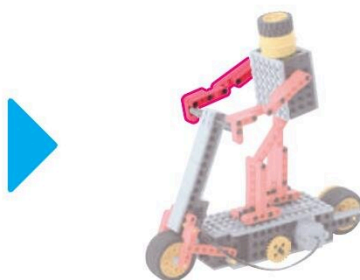

⑤ひだりうで





1 あたま

めやす 5 ふん



タイヤ S 1こ



タイヤ L 1こ



シャフト 6ポチ 1こ



ながさに  
ちゅうい

1



はずす



こむ  
ゴムをはずすのは  
せんせいに  
やってもらおう

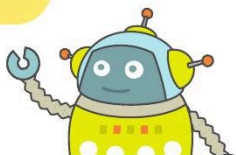



びいむろくほち  
ビーム 6 ポチ 2こ



びいむにほち  
ビーム 2 ポチ 1こ



びいむよんほち  
ビーム 4 ポチ 1こ

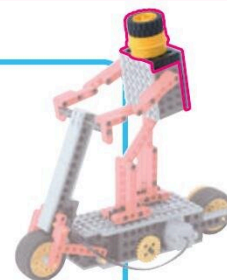

2

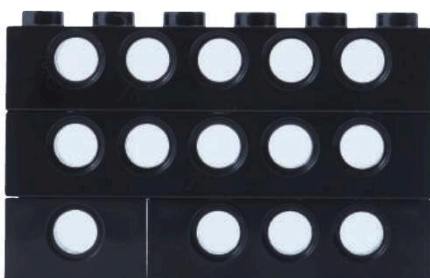



ふれえとる  
プレートL 1こ

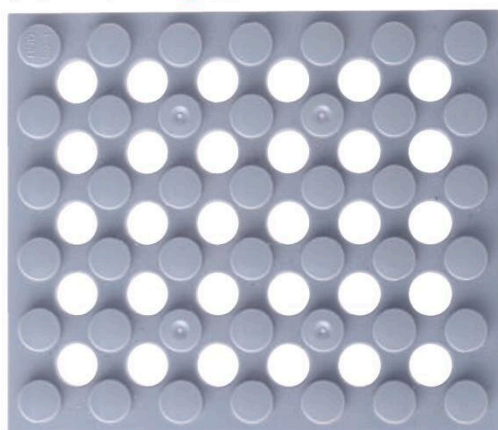

3

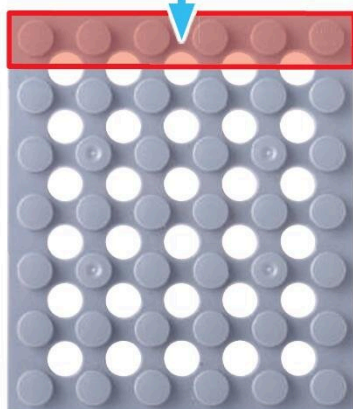
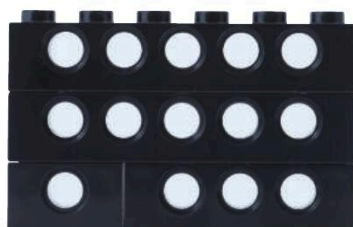

ながさに ちゅうい  
みじかい

⑥ 5 4 3 2 1

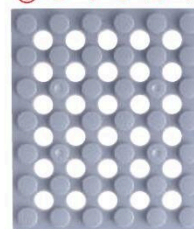

ながい



ぶっしゅ  
ブッシュ 1こ



4

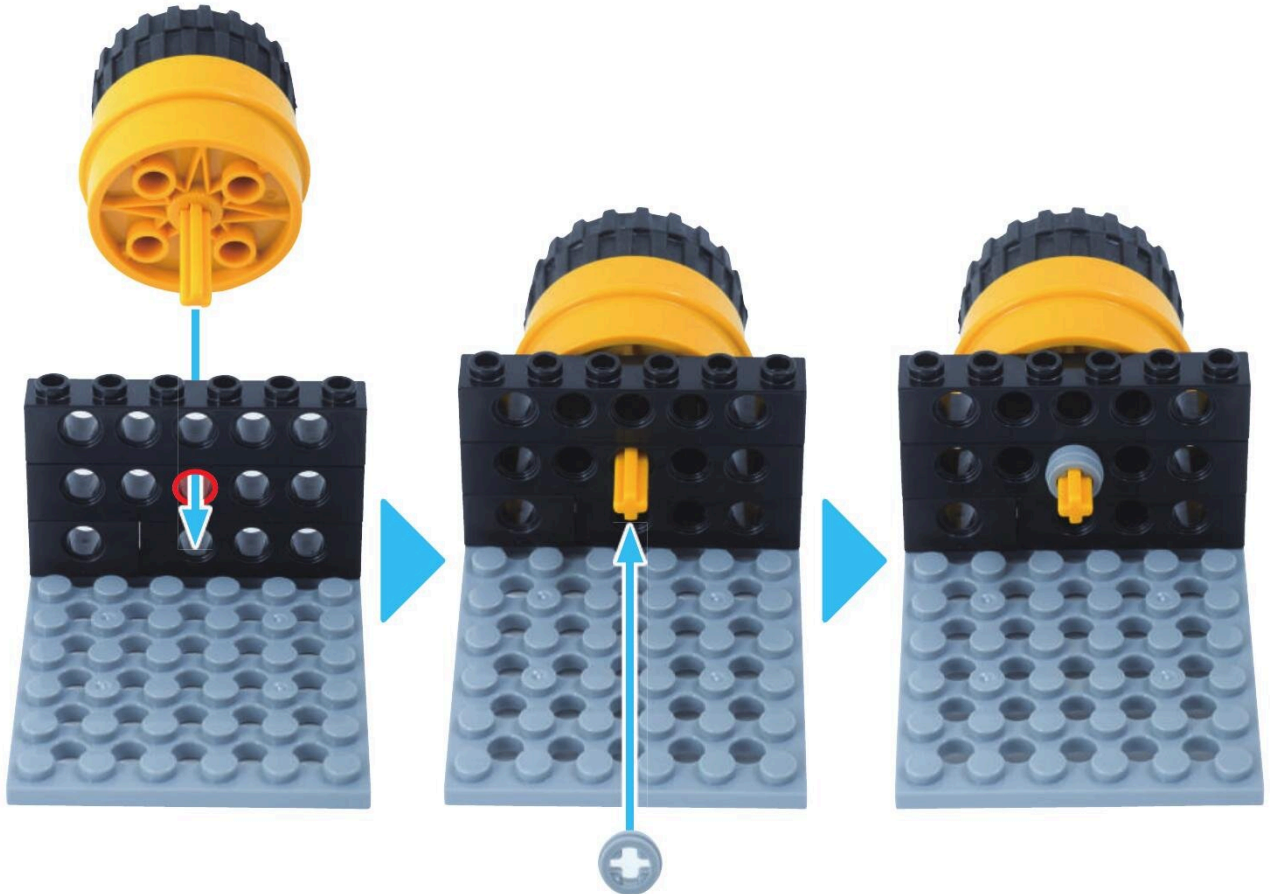

あたまが  
かんせい!

やったね!



# 2 ひだりあし

めやす 10 ぶん

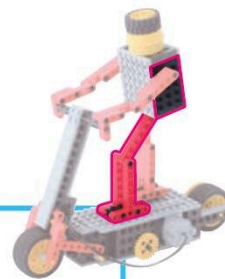

ろっど きゅう あな  
ロッド 9 アナ 1こ



pegu<sup>え</sup>る<sup>る</sup>  
ペグ L 3こ



てい ろっど  
T ロッド 1こ

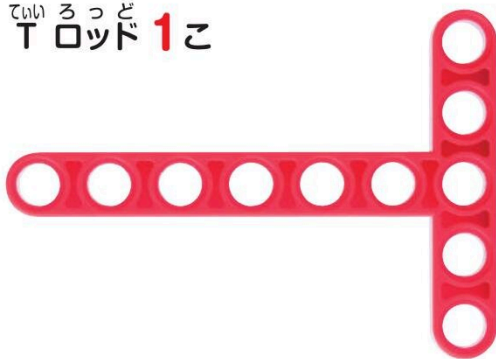

pegu<sup>え</sup>る<sup>る</sup>  
ペグ S 1こ



1

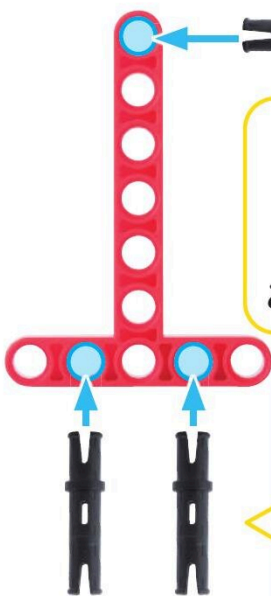
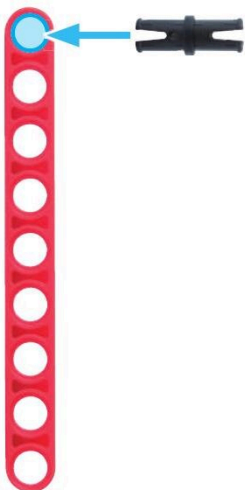

むきに ちゅうい



こちらを さしこむ

むきに ちゅうい



こちらを さしこむ

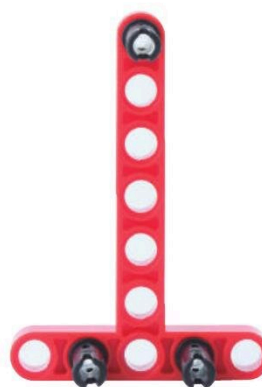



びいむ ほち  
ビーム4ポチ 1こ

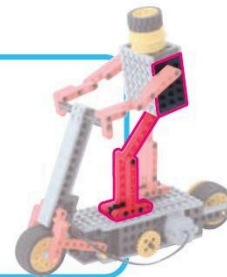

2

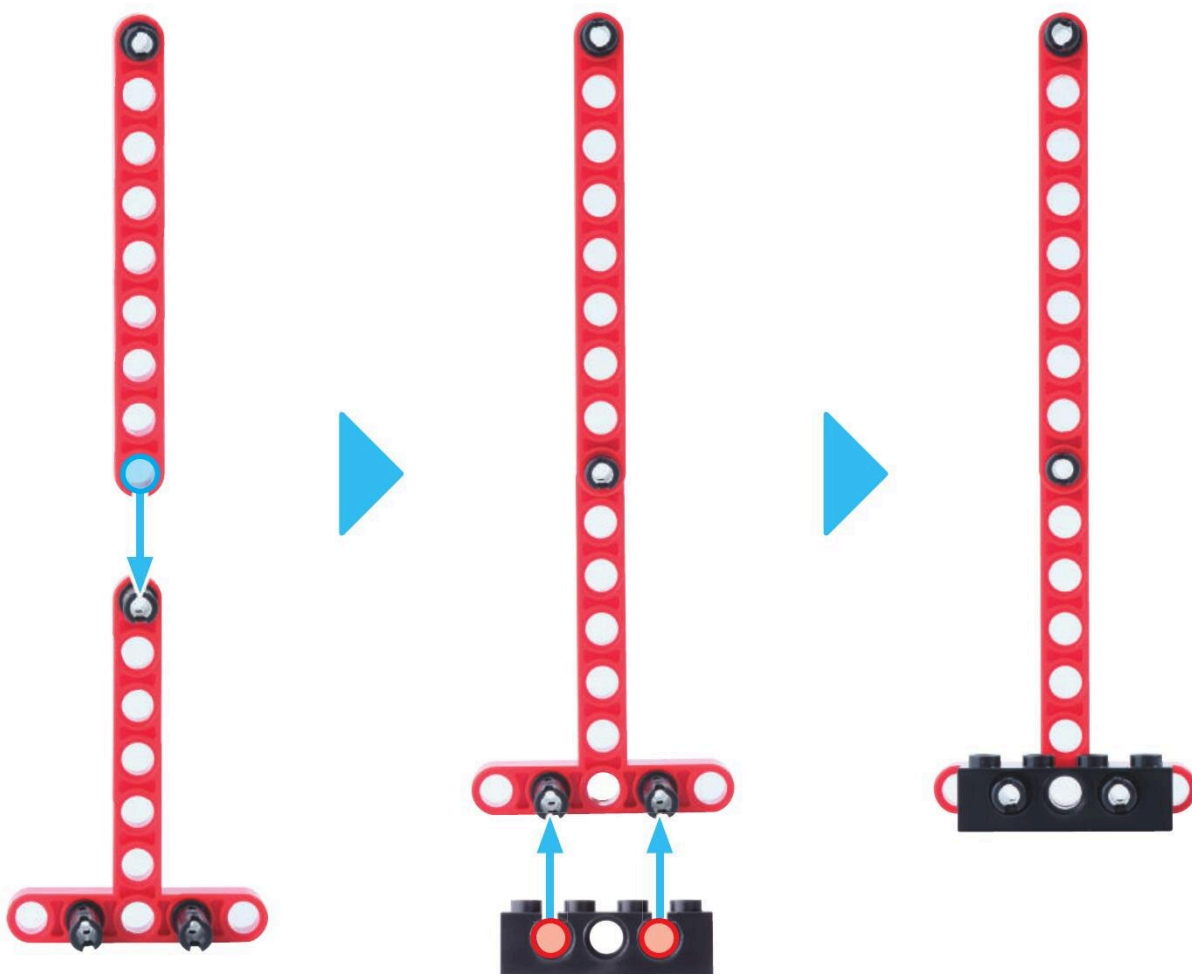



びいむろくほち  
ビーム6ポチ3こ

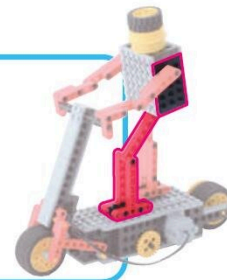

4

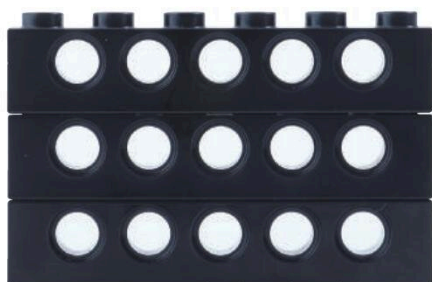

5

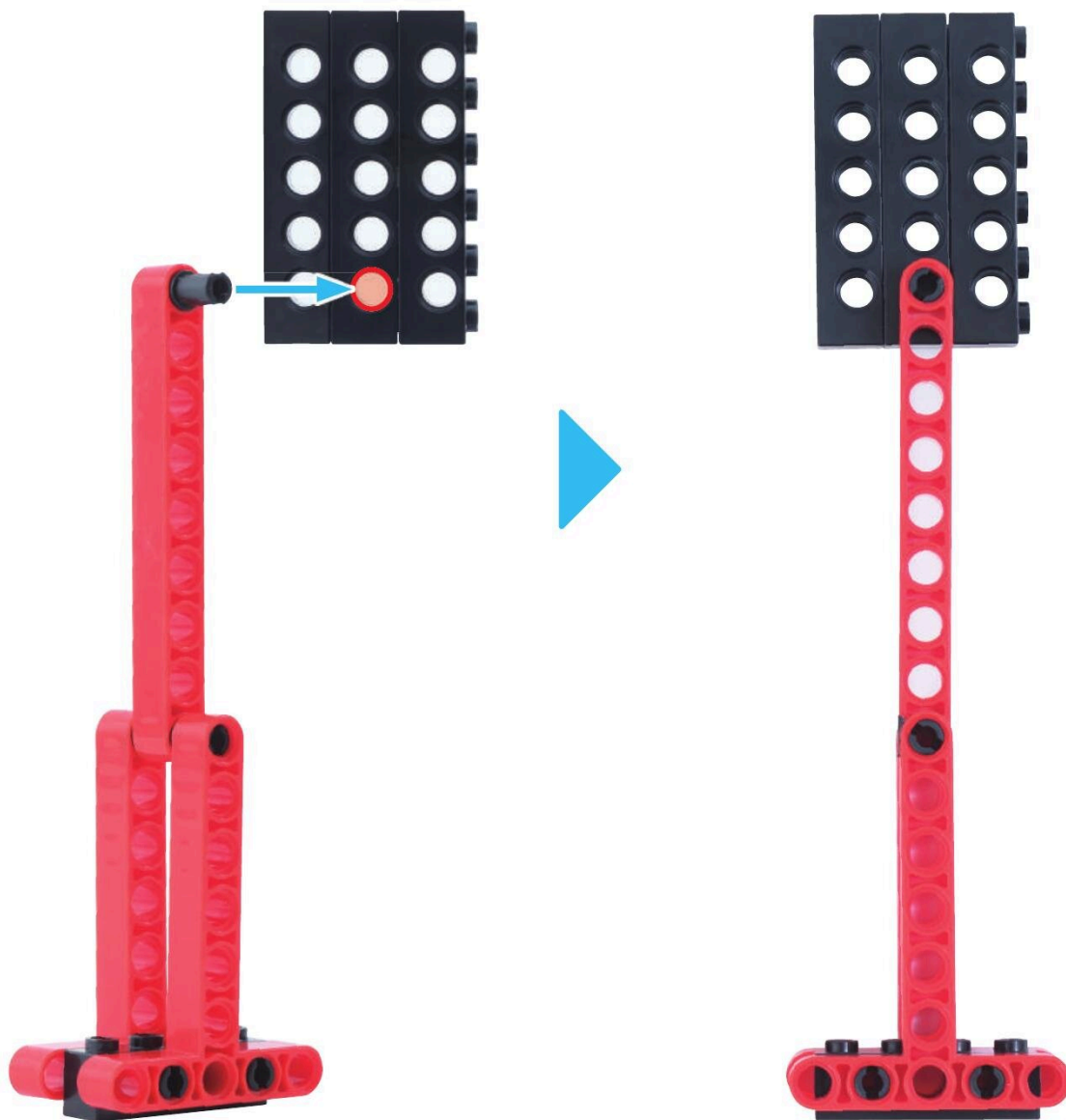



6

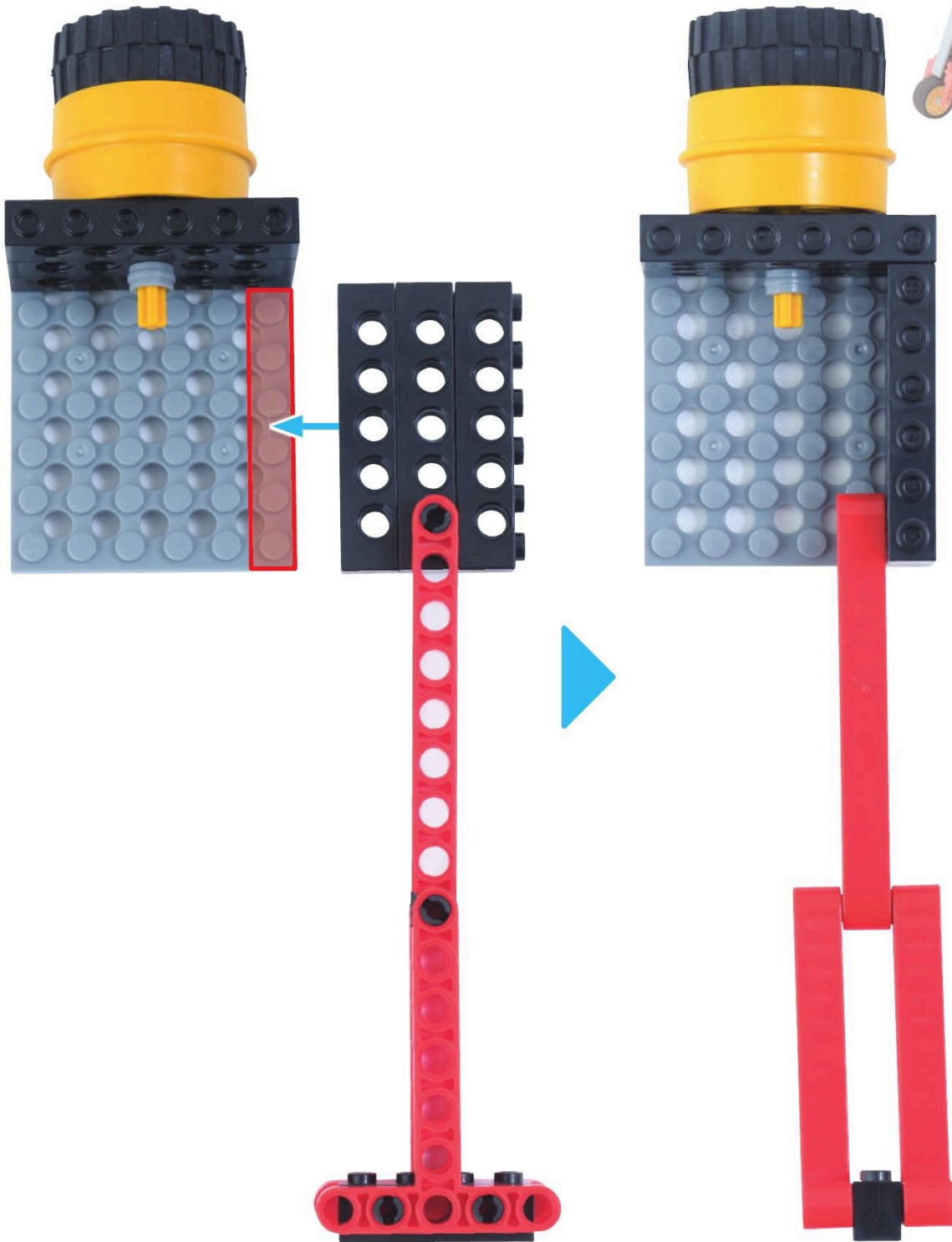

ひだりあしと  
あたまが がつたい!

やったね!



3 みぎあし

めやす 10 ぶん



ろっど 15 アナ 1こ



てい ろっど T ロッド 1こ

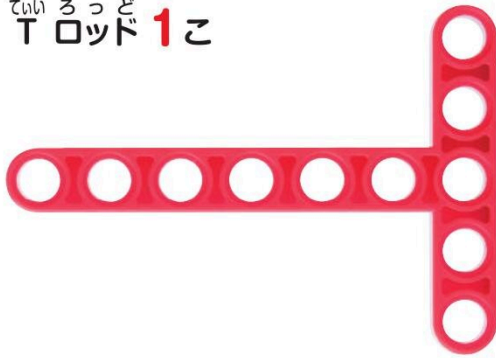

peg 4こ



peg S 1こ



1

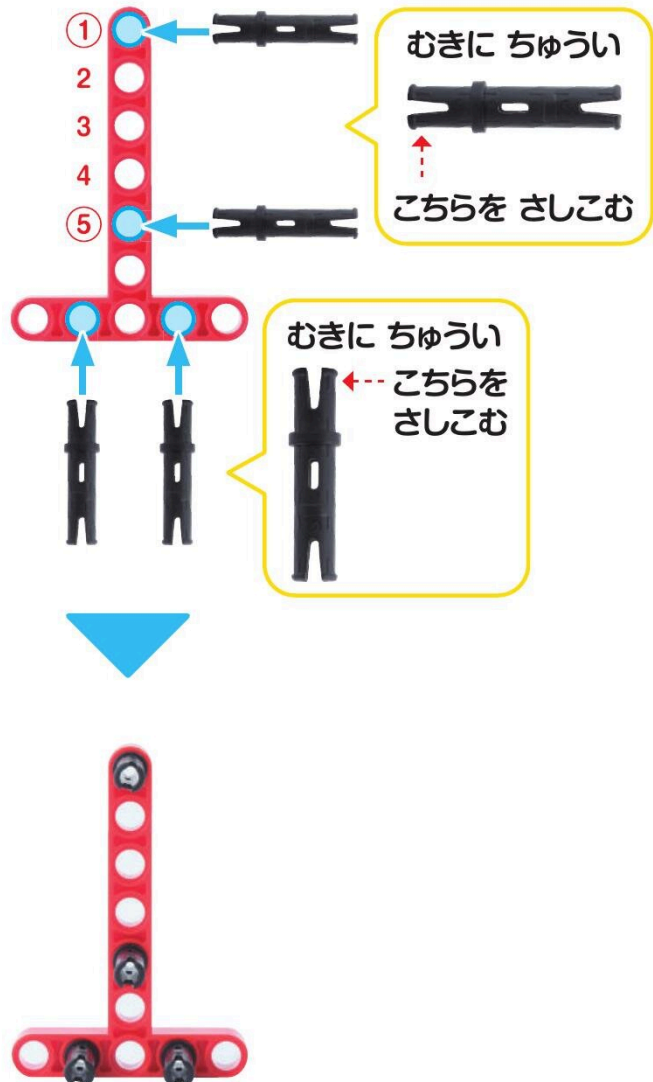
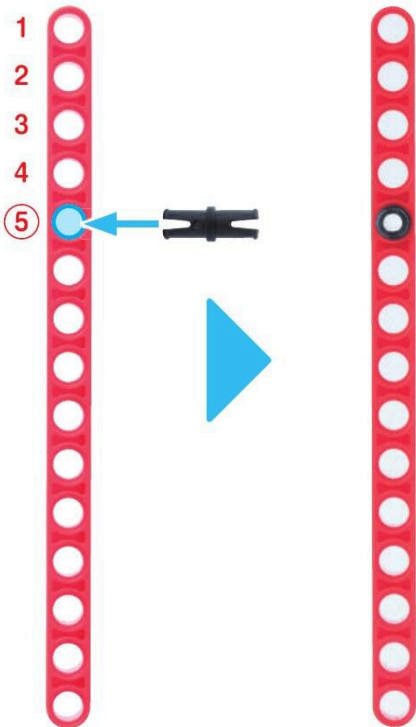

びいむ ほち  
ビーム4ポチ 1こ

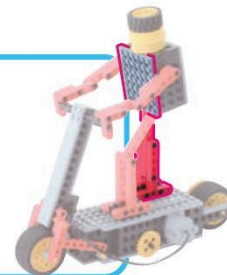

2

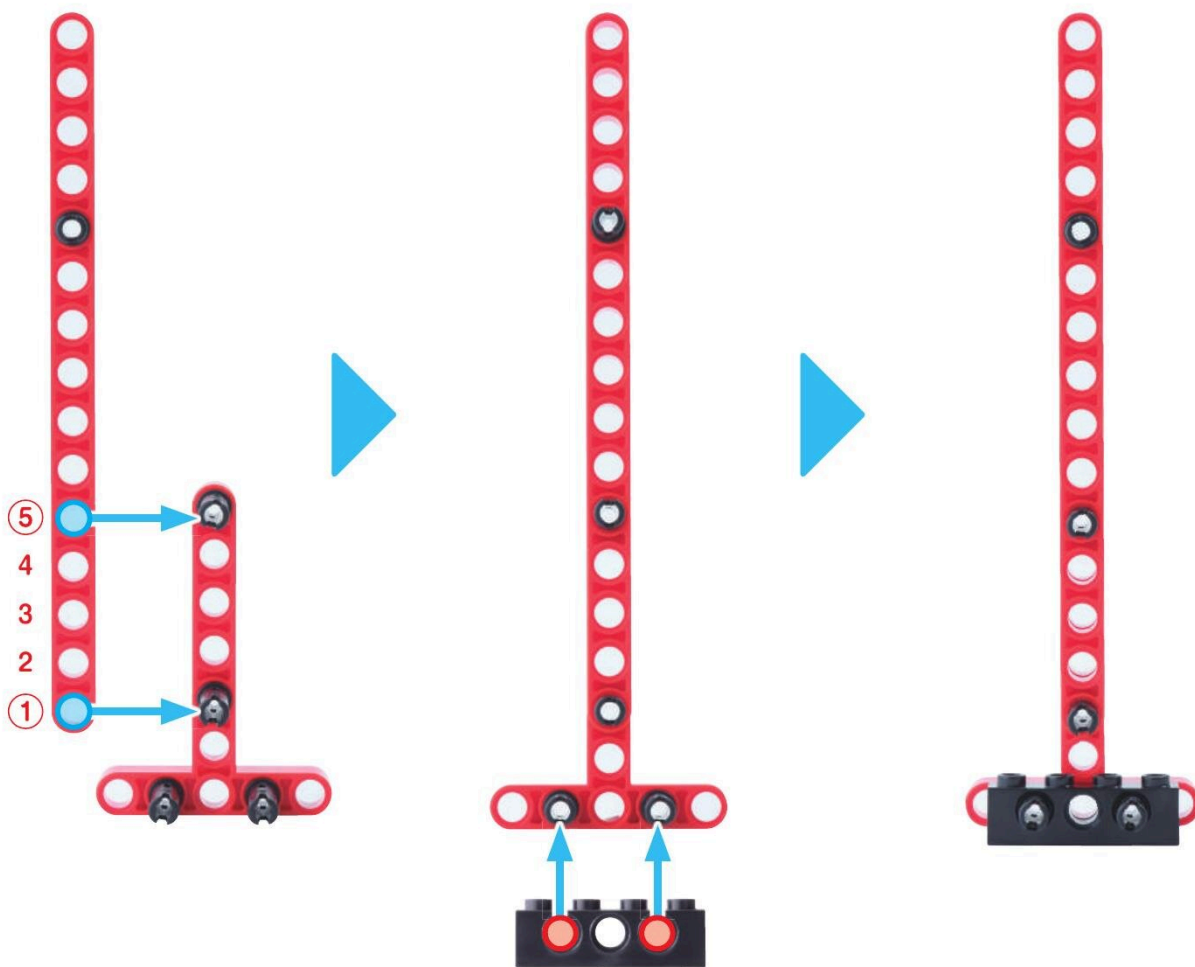





びいむろくほち  
ビーム6ポチ3こ

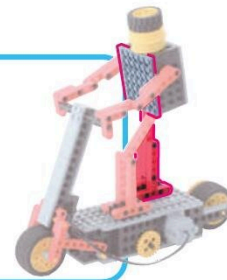

4

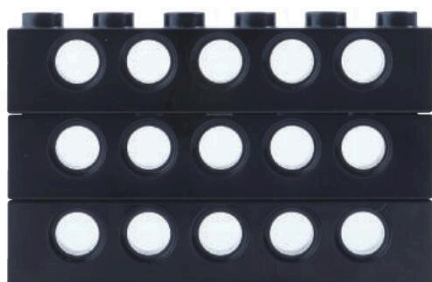

5



6

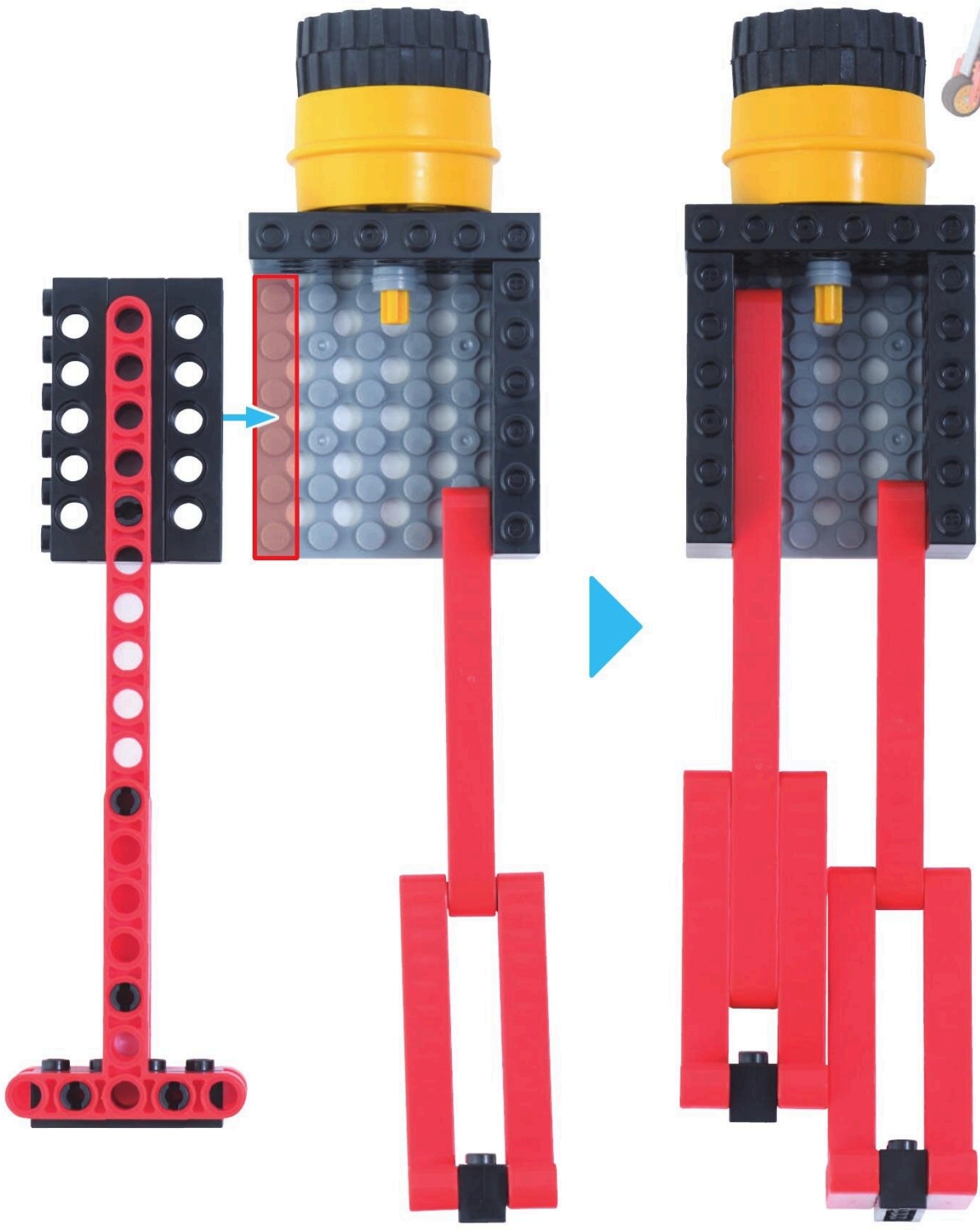

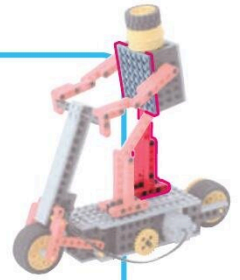

ふれえとろ  
プレートL 1こ

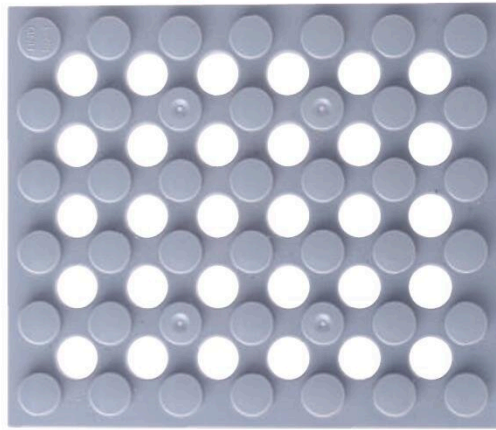

7

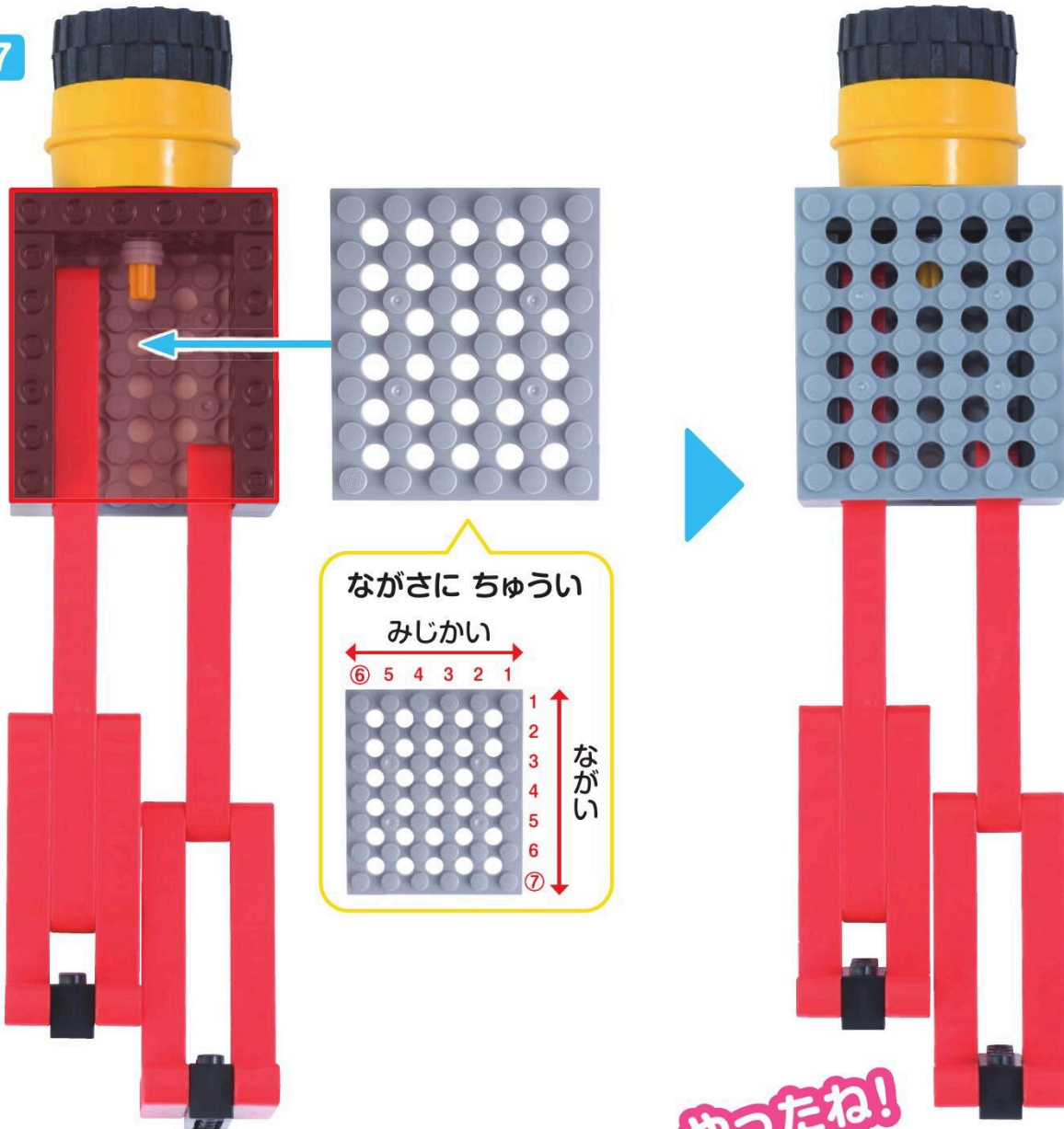

やったね!

みぎあしと あたまが  
がつたい!

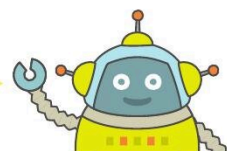



4

みぎうで

めやす 10 ぶん



ろっど<sup>な</sup>アナ 1こ  
ロッド7

ろっど<sup>ろ</sup>シ 1こ

peg<sup>く</sup>え<sup>る</sup> 1こ

peg<sup>く</sup>え<sup>す</sup> S 4こ

1

むきに ちゅうい  
peg<sup>く</sup>え<sup>す</sup> S  
こちらを さしこむ

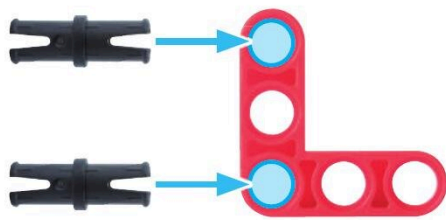
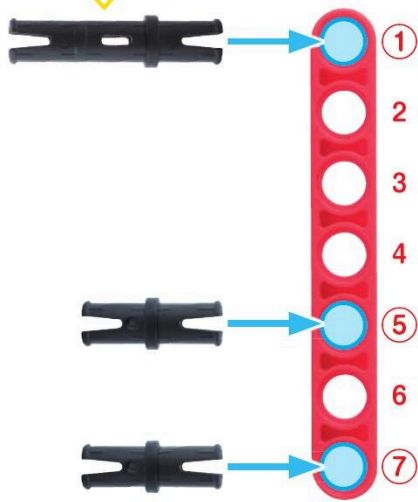



3

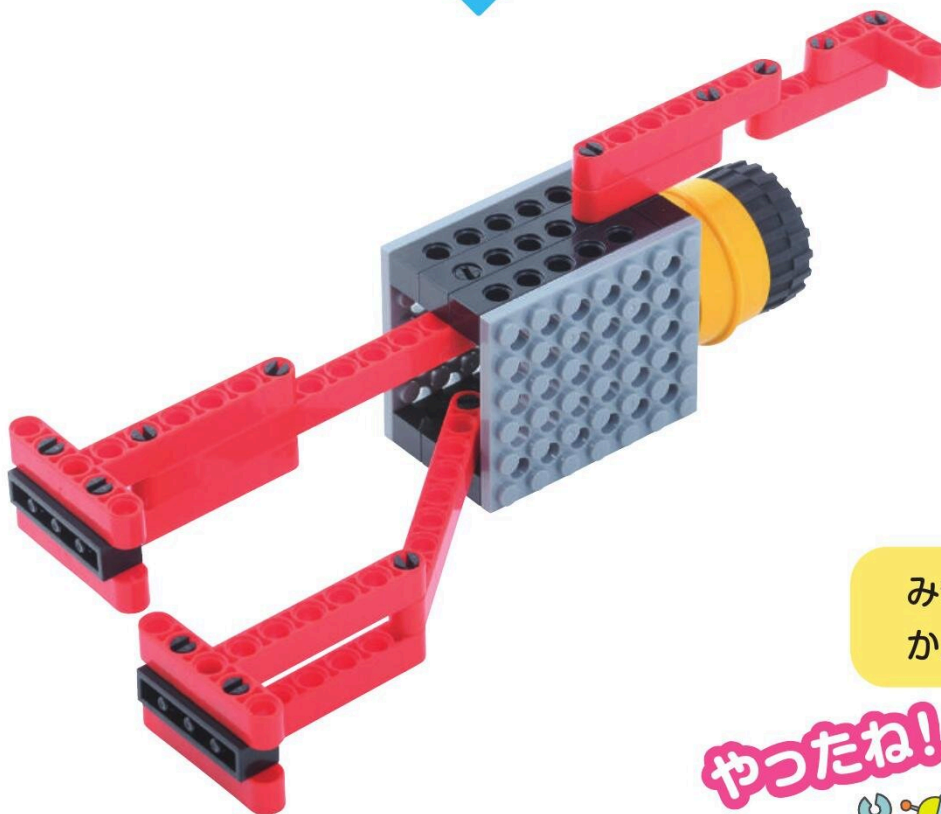
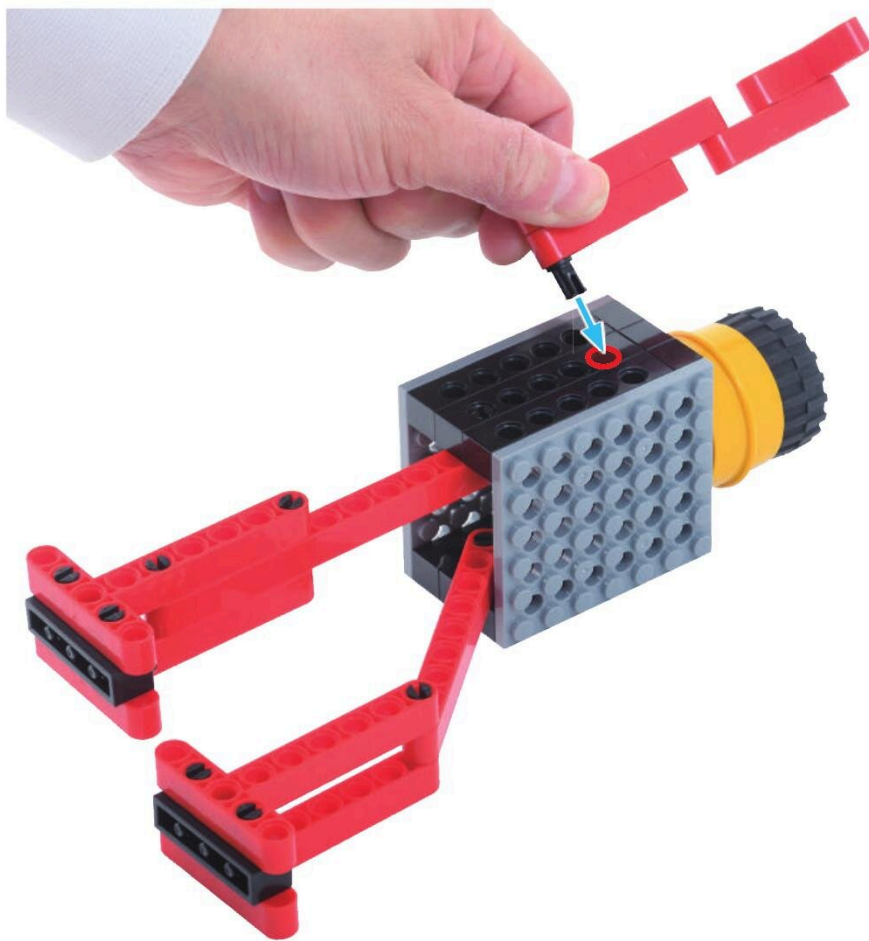

みぎうでが  
かんせい!

やったね!

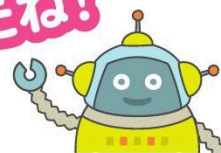

5 ひだりうで

めやす 15 ぶん



ろっど<sup>な</sup>ア<sup>な</sup>ナ 1こ  
ロッド7



peg<sup>え</sup>シ 1こ  
ペグ



peg<sup>え</sup>S 4こ  
ペグ



ろっど<sup>え</sup>シ 1こ  
Lロッド



1

むきにちゅうい  
↑  
こちらをさしこむ

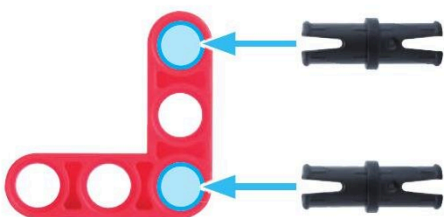
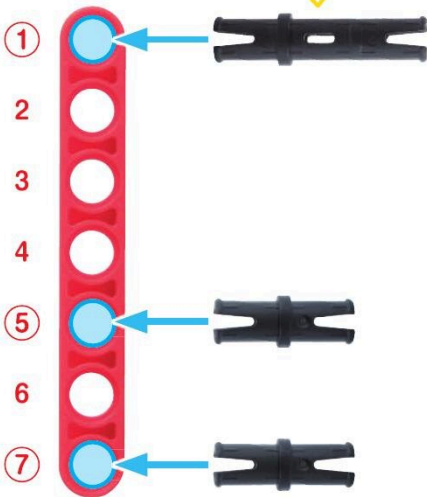





3

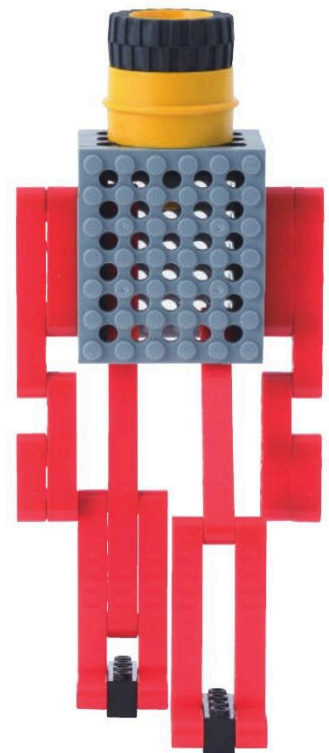

ひとが  
かんせい!

やったね!

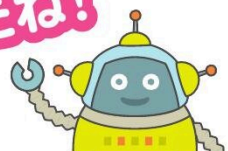

ほそぶれえとくほち  
細プレート6ポチ 2こ



ほそぶれえとゆほち  
細プレート4ポチ 2こ



4

はんとる  
ハンドルをたてて  
すとおっぱあ  
ストッパーを  
もどしておこう

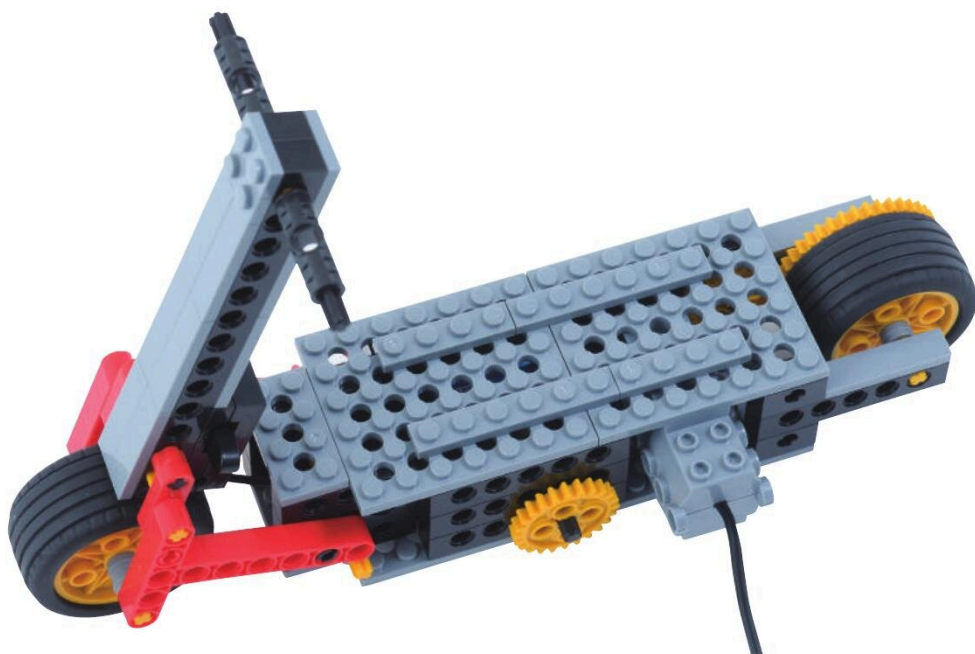
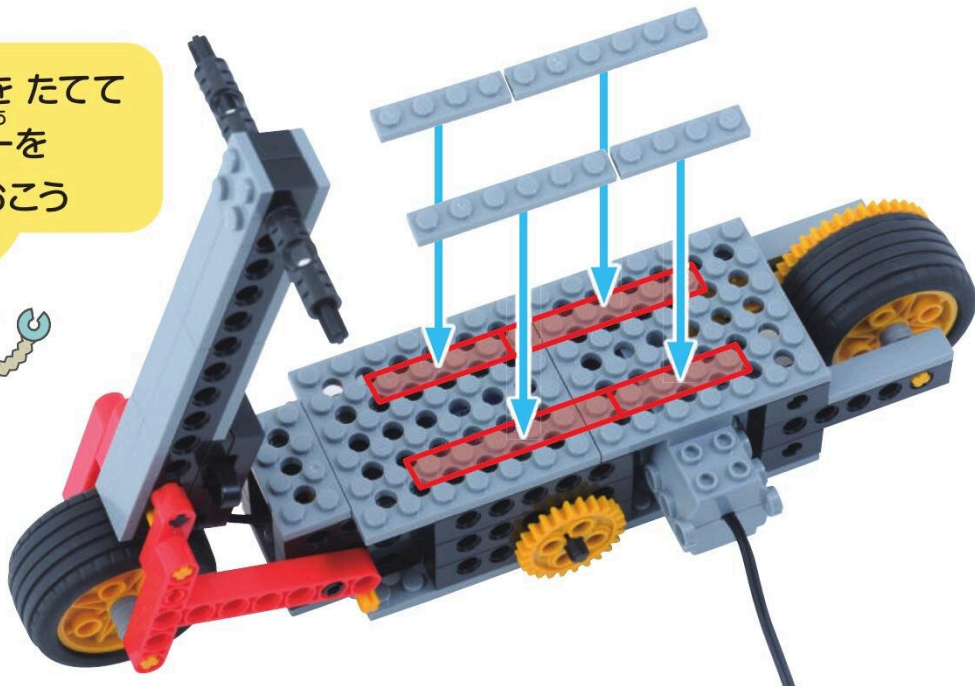
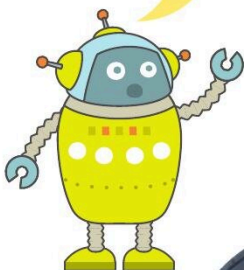



5

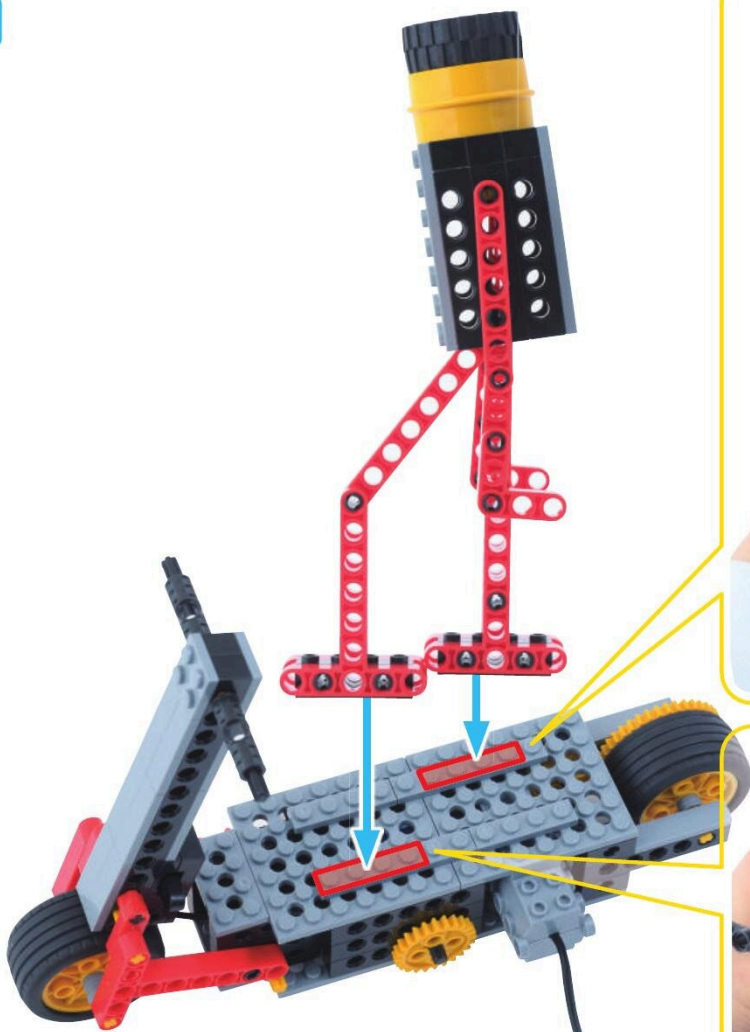

てで もちあげて  
ゆびで おさえて  
とりつけよう





6

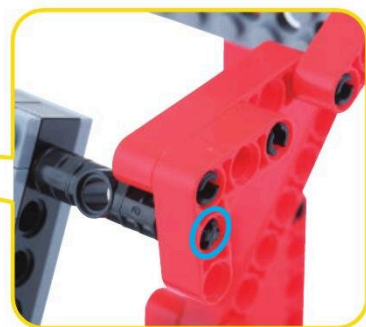

るほっと  
ロボットが  
かんせい!

よくできました!

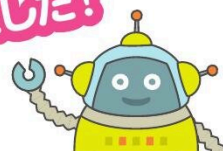

# ろぼっと ロボットを うごかそう

めやす 5 ぶん

こおど  
コードをつなごう

す と っ ぱ あ  
ストッパーの  
あなの いちを  
かくにん

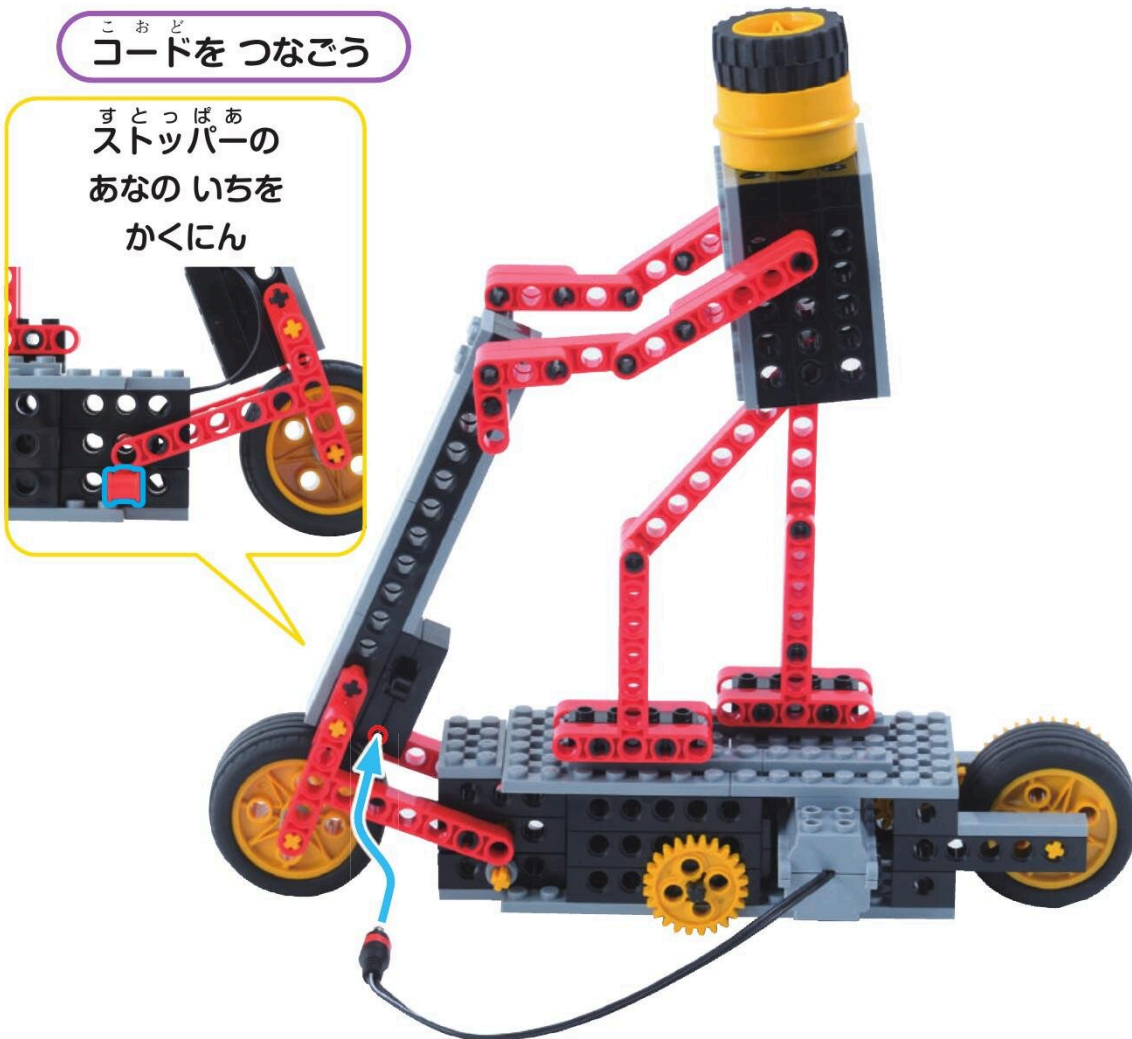

す い っ ち  
スイッチを 入れて うごかそう



ろぼっと  
ロボットは  
まえに すすんだかな？

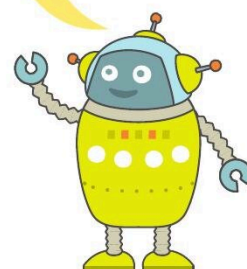

ゴールをつくってはしらせよう

めやす 15 ぶん



あまった<sup>ばあつ</sup>パーツ<sup>つか</sup>を使って  
ゴール<sup>ごおる</sup>をつく<sup>つく</sup>てみたよ

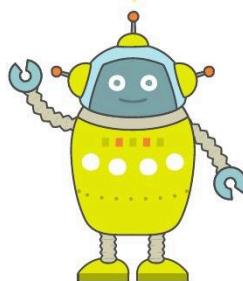



# じゆうにかいぞうしてみよう

めやす 10 ぶん

ばあつ  
パーツをつかって、じゆうにかいぞうしてみよう！





# まちがいさがし

めやす 3 ぶん



ちがうところを みつけよう  
2つあるよ!

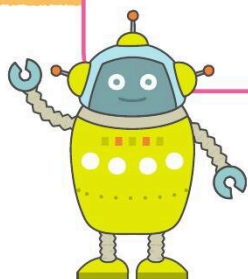

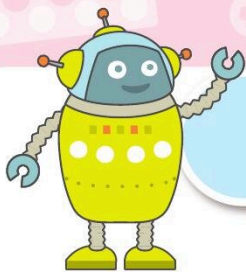

# これからつくるロボットを しょうかいするよ

プレプライマリーコース

プライマリーコース

## 5がっ るびと ロビット

ぴよんぴよん  
うさぎ



うさぎのように  
ぴよんぴよんうごくよ

## 6がっ すしろぼお スシロボ

えびうに  
エビウニ  
まくろ!

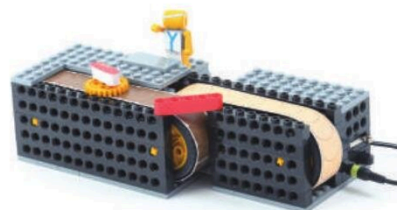

れえん  
レーンのうえを  
おすがうごいていくよ

## 7がっ おはなっち オハナッチ

きれいにさいたよ



くるくるまわる、  
きれいなおはながさくよ!

## 8がっ めかびいとる メカビートル

かぶとむし  
カブトムシ  
ロボット

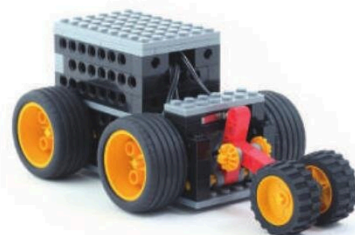

じどうでとまる かわいいロボットだよ

## 5がっ うおおかあたくしい ウォーカータクシー

じんりきしゃ  
るぼと  
ロボット



## 6がっ ちゃりだあ チャリダー

じてんしゃ  
るぼと  
ロボット



## 2025年開催のイベントのお知らせ

### ロボット教室全国大会

8月23日(土) 東京大学安田講堂

5月上旬  
募集要項公開

### STREAM 地区フェス (旧スペシャル地区イベント)

全国7地区、7~8月に開催 日程、会場、内容は順次公開

札幌、仙台、東京、名古屋、大阪、福岡、沖縄

ロボットの展示発表に加えてロボプロや色々な企画も!

### クリエイティブロボティクスコンテスト (旧ロボプロ全国大会)

2025年秋、東京にて開催予定

## SNSアカウント

フォローお願いします!



YouTube



@human\_junior



ヒューマンアカデミー  
こどもちゃんねる



ヒューマンアカデミー  
ジュニア



@human\_CECoe





# ぷ ら い ま り - こ - す プライマリーコース



**Human**  
ヒューマンアカデミー ジュニア



ロボット教室

にんきの  
ロボットが  
たくさん!

いろいろな  
ロボットが  
つくれるよー!  
プライマリーコースでは

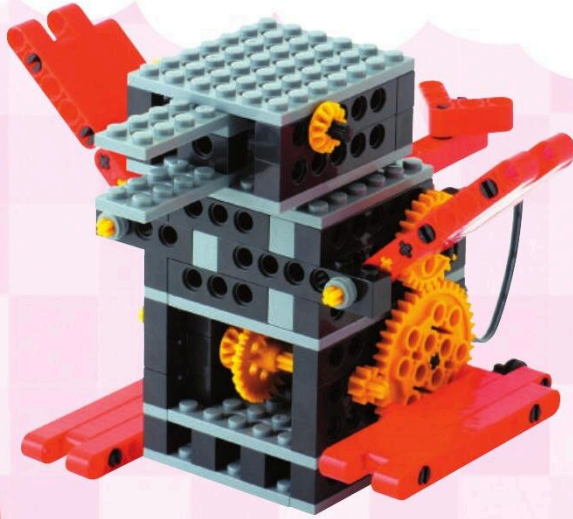

ろぼだっく  
ロボダック



ろぼどーざー  
ロボドーザー



ちゃりだー  
チャリダー

ぜんぶで  
12しゅるい!



えすえるろぼころ  
Sロボコ



はんど  
のびるハンド

プライマリーコース  
になると、  
クリアピンクを  
プレゼント!

とくべつなパイロットが  
もらえる!!



べーしゅくこーす  
ベシックコース

みどろこーす  
ミドルコース

あどぼんごこーす  
アドバンスコース

あたらしいコースがはじまるときにももらえるよ!  
たのしみにしていてね!

